



US00D407639S

United States Patent [19]

[11] Patent Number: Des. 407,639

Ishii

[45] Date of Patent: **Apr. 6, 1999

[54] CONTAINER PACKAGE FOR SOLID INK

[75] Inventor: Makoto Ishii, Nagoya, Japan

[73] Assignee: Brother Kogyo Kabushiki Kaisha, Nagoya, Japan

[**] Term: 14 Years

[21] Appl. No.: 64,798

[22] Filed: Jan. 10, 1997

[30] Foreign Application Priority Data

Jul. 22, 1996	[JP]	Japan	8-22122
Jul. 22, 1996	[JP]	Japan	8-22123
Jul. 22, 1996	[JP]	Japan	8-22124
Jul. 22, 1996	[JP]	Japan	8-22125

[51] LOC (6) Cl. 09-03

[52] U.S. Cl. D9/414; D9/456; D9/345

[58] Field of Search D18/56; 347/86-88; D9/414, 456, 345, 424, 455; 206/386, 600, 444; 108/56.3, 57.13, 901

[56] References Cited

U.S. PATENT DOCUMENTS

D. 214,971 8/1969 Buck D9/424

(List continued on next page.)

Primary Examiner—Cathy Anne MacCormac
Attorney, Agent, or Firm—Oliff & Berridge, PLC

[57] CLAIM

The ornamental design for a container package for solid ink, as shown and described.

DESCRIPTION

FIG. 1 is a top plan view of a holder for a solid ink;
 FIG. 2 is a front view thereof;
 FIG. 3 is a bottom plan view thereof;
 FIG. 4 is a left side view thereof;
 FIG. 5 is a right side view thereof;
 FIG. 6 is a rear view thereof;
 FIG. 7 is a top perspective view thereof;
 FIG. 8 is a bottom perspective view thereof;
 FIG. 9 is another bottom perspective view thereof with the solid ink removed;
 FIG. 10 is a cross sectional view taken along line 10—10 of FIG. 3;
 FIG. 11 is a cross sectional view taken along line 11—11 of FIG. 3;
 FIG. 12 is a cross sectional view taken along line 12—12 of FIG. 3;
 FIG. 13 is a partial view showing the indentation in the central section of FIG. 1;

FIG. 14 is a top plan view of a second embodiment of FIG. 1;
 FIG. 15 is a front view of FIG. 14;
 FIG. 16 is a bottom plan view of FIG. 14;
 FIG. 17 is a left side view of FIG. 14;
 FIG. 18 is a right side view of FIG. 14;
 FIG. 19 is a rear view of FIG. 14;
 FIG. 20 is a top perspective view of FIG. 14;
 FIG. 21 is a bottom perspective view of FIG. 14;
 FIG. 22 is another bottom perspective view of FIG. 14 with the solid ink removed;
 FIG. 23 is a cross sectional view taken along line 23—23 of FIG. 16;
 FIG. 24 is a cross sectional view taken along line 24—24 of FIG. 16;
 FIG. 25 is a cross-sectional view taken along line 25—25 of FIG. 16;
 FIG. 26 is a partial view showing the indentation in the central section of FIG. 14;
 FIG. 27 is a top plan view of a third embodiment of FIG. 1;
 FIG. 28 is a front view of FIG. 27;
 FIG. 29 is a bottom plan view of FIG. 27;
 FIG. 30 is a left side view of FIG. 27;
 FIG. 31 is a right side view of FIG. 27;
 FIG. 32 is a rear view of FIG. 27;
 FIG. 33 is a top perspective view of FIG. 27;
 FIG. 34 is a bottom perspective view of FIG. 27;
 FIG. 35 is another perspective view of FIG. 27 with the solid ink removed;
 FIG. 36 is a cross sectional view taken along line 36—36 of FIG. 29;
 FIG. 37 is a cross sectional view taken along line 37—37 of FIG. 29;
 FIG. 38 is a partial view showing the indentation in the central section of FIG. 27;
 FIG. 39 is a top plan view of a fourth embodiment of FIG. 1;
 FIG. 40 is a front view of FIG. 39;
 FIG. 41 is a bottom plan view of FIG. 39;
 FIG. 42 is a left side view of FIG. 39;
 FIG. 43 is a right side view of FIG. 39;
 FIG. 44 is a rear view of FIG. 39;
 FIG. 45 is a top perspective view of FIG. 39;
 FIG. 46 is a bottom perspective view of FIG. 39;
 FIG. 47 is another bottom perspective view of FIG. 39 with the solid ink removed;
 FIG. 48 is a cross sectional view taken along line 48—48 of FIG. 41;
 FIG. 49 is a cross sectional view taken along line 49—49 of FIG. 41; and,
 FIG. 50 is a partial view showing the indentation in the central section of FIG. 39.

The broken lines in FIGS. 8, 21, 34, and 46 are for purposes of illustration only and form no part of the claimed design.

1 Claim, 20 Drawing Sheets

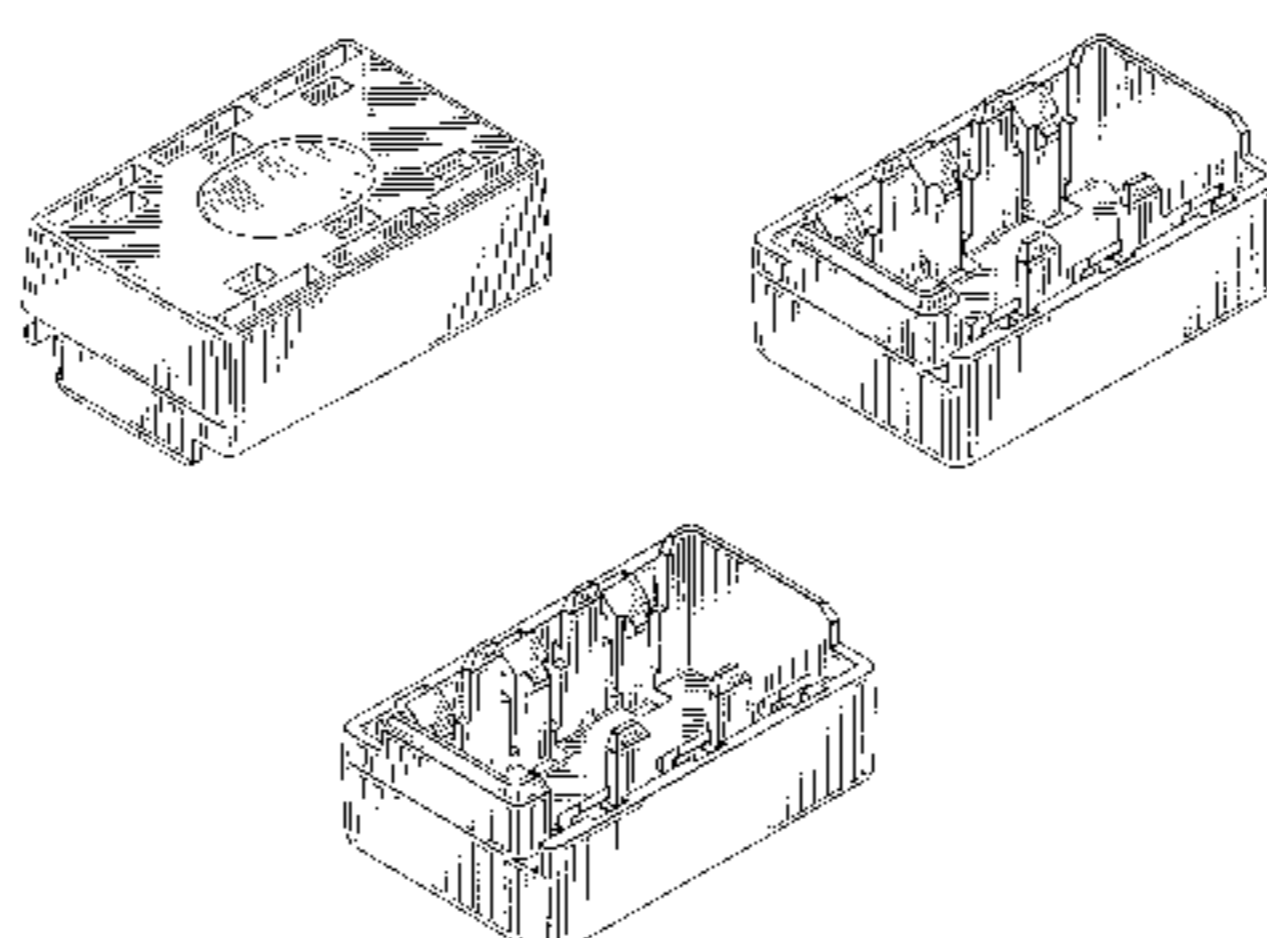

U.S. PATENT DOCUMENTS

D. 231,421	4/1974	Spydevold	D9/456	D. 348,394	7/1994	Dreyer	D9/424
D. 234,752	4/1975	Paone	D9/456	D. 351,103	10/1994	Reynolds	D9/455
D. 240,117	6/1976	Skagmo	D9/456	D. 361,514	8/1995	Krupa et al.	D9/456
D. 240,900	8/1976	Rogery et al.	D9/456	2,696,293	12/1954	Testi	108/901
D. 244,580	6/1977	Keough	D9/456	4,606,278	8/1986	Shuert	108/901
D. 267,542	1/1983	Paone	D9/345	4,742,933	5/1988	Panick	108/56.3
D. 270,346	8/1983	Smith	D9/456	4,989,731	2/1991	Shuert	206/386
D. 281,484	11/1985	Dickes	D9/456	5,253,756	10/1993	Goekler	206/444
D. 284,841	7/1986	Rowland et al.	D9/456	5,275,289	1/1994	Blatt	206/386
D. 306,185	2/1990	Ukisu	D9/414	5,307,931	5/1994	Gillispie et al.	206/386
D. 306,402	3/1990	Colla	D9/414	5,392,911	2/1995	Gillispie et al.	206/386
D. 310,485	9/1990	Harvey	D9/424	5,497,709	3/1996	Gonzalez et al.	108/56.3
D. 319,940	9/1991	Ehlebracht	D9/414	5,537,937	7/1996	Juvik-woods	108/56.3
D. 319,978	9/1991	Wolff	D9/424	5,606,921	3/1997	Elder et al.	108/901
D. 330,162	10/1992	Verchere	D9/424	5,664,394	9/1997	Sweeney	108/56.3
					5,687,652	11/1997	Ruma	108/901

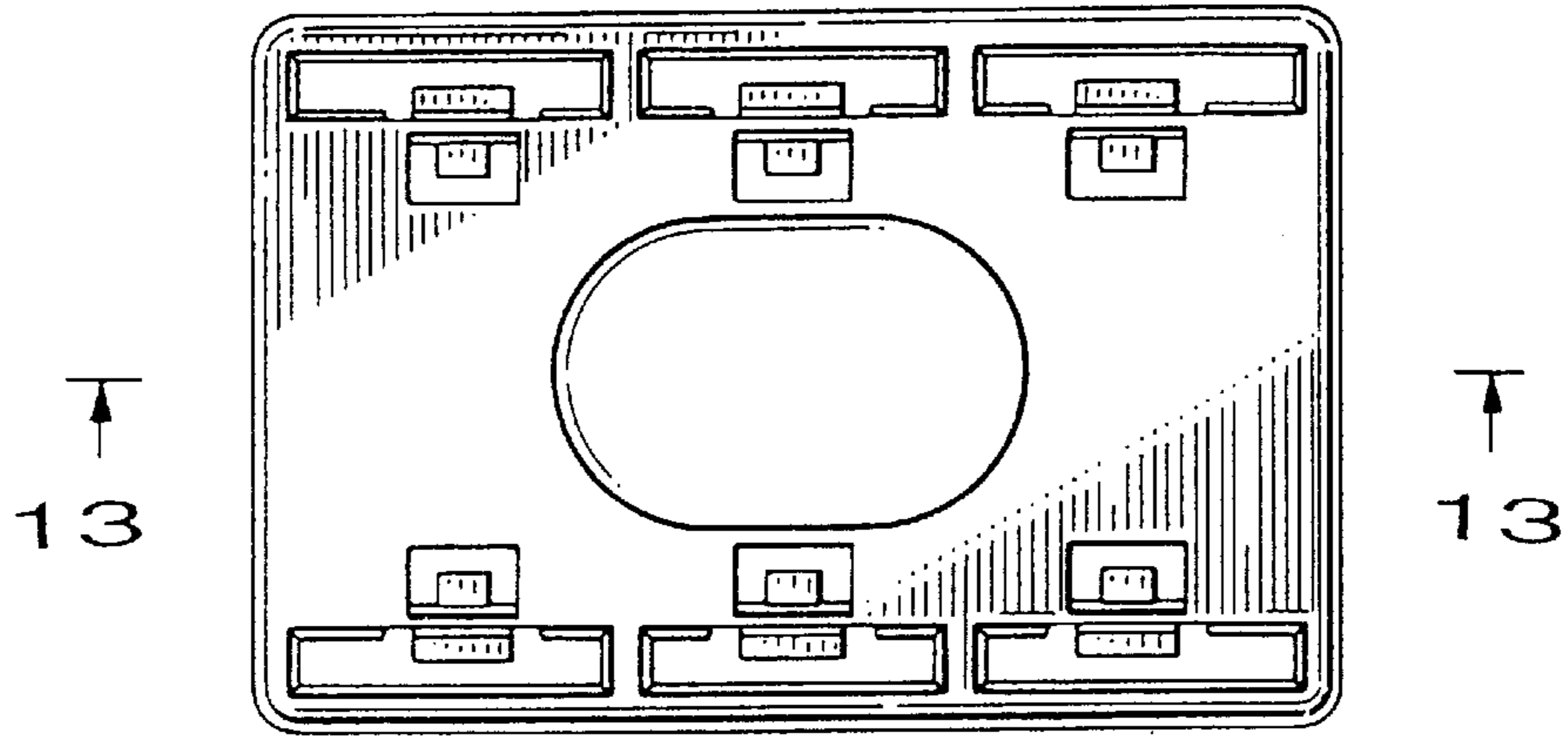

FIG. 1

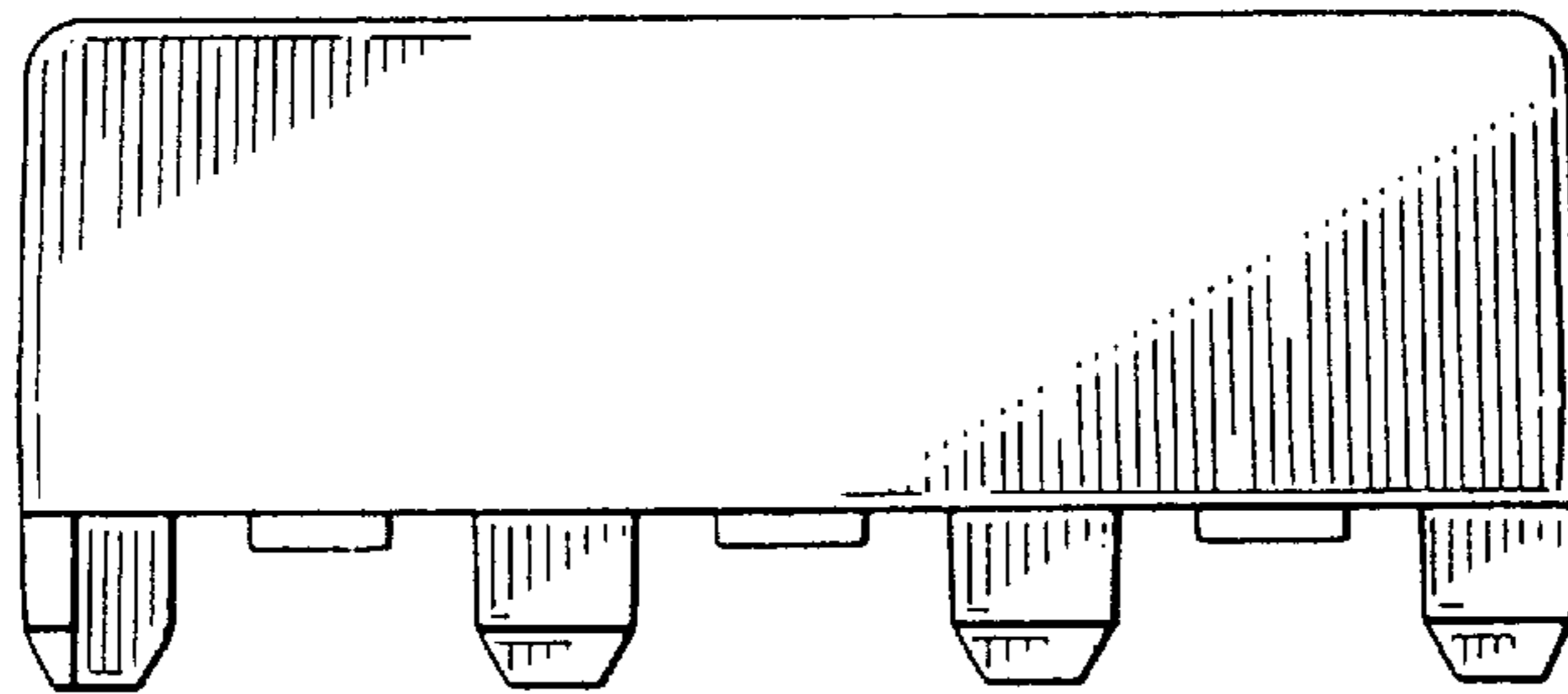

FIG. 2

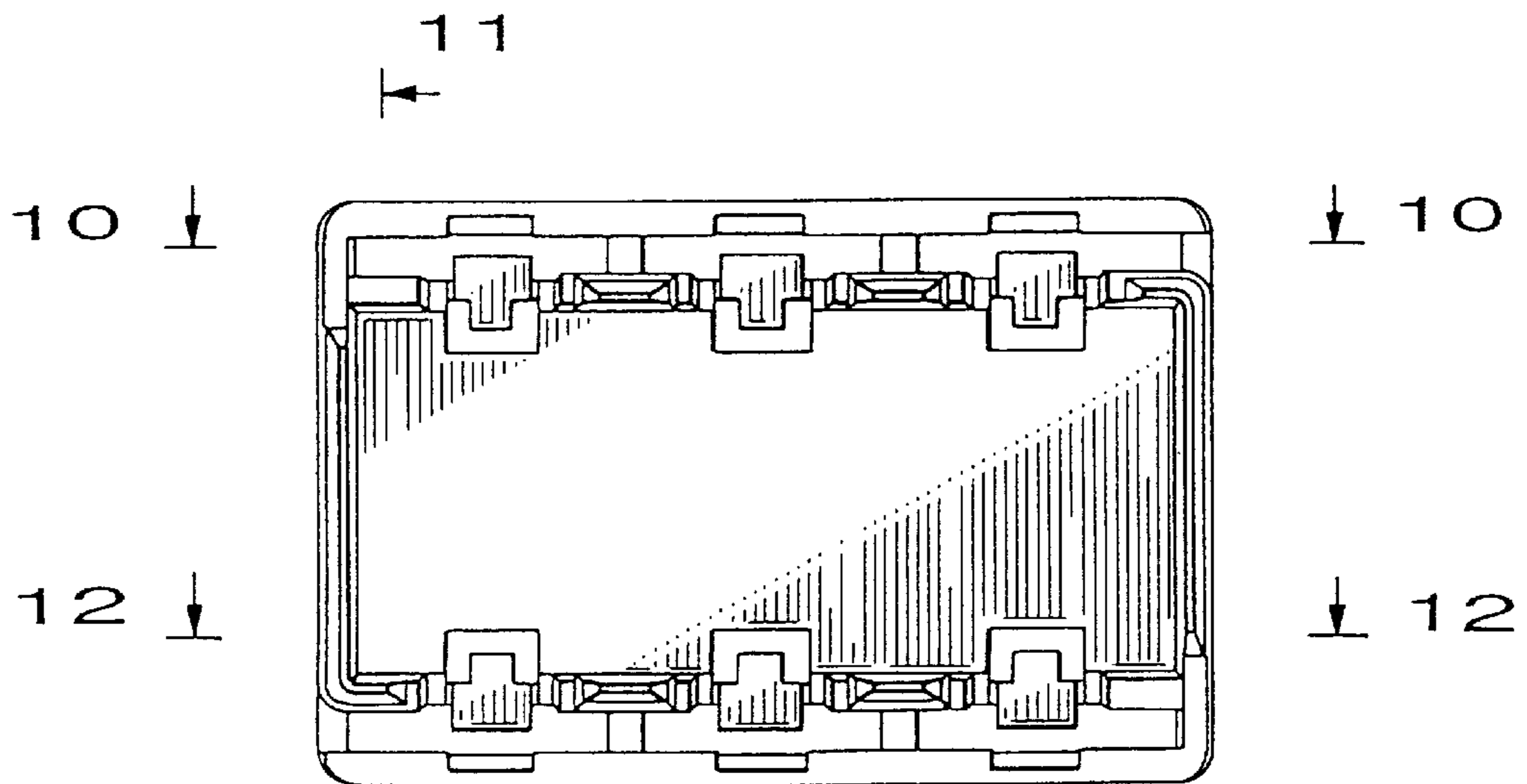

FIG. 3

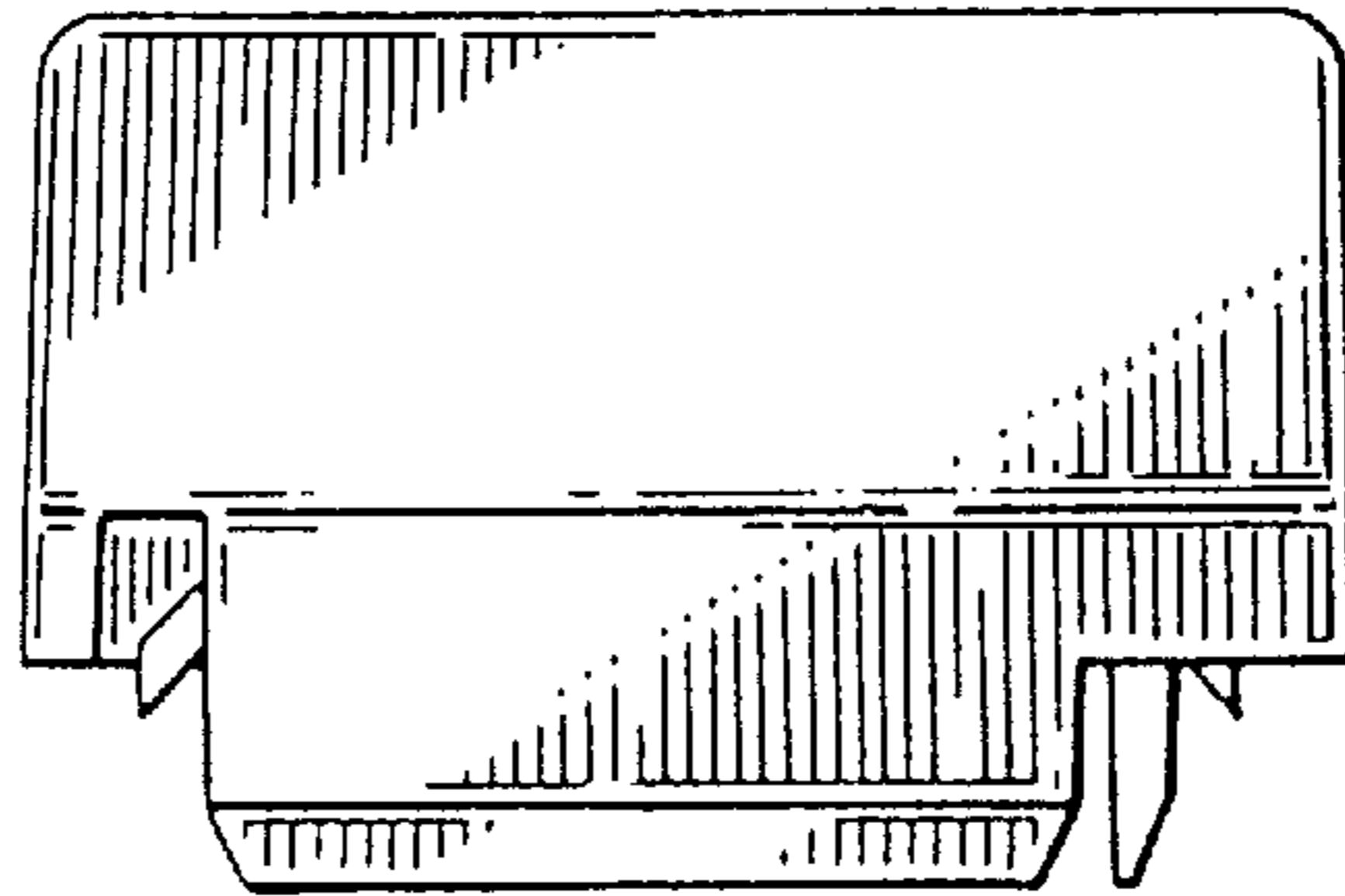

FIG. 4

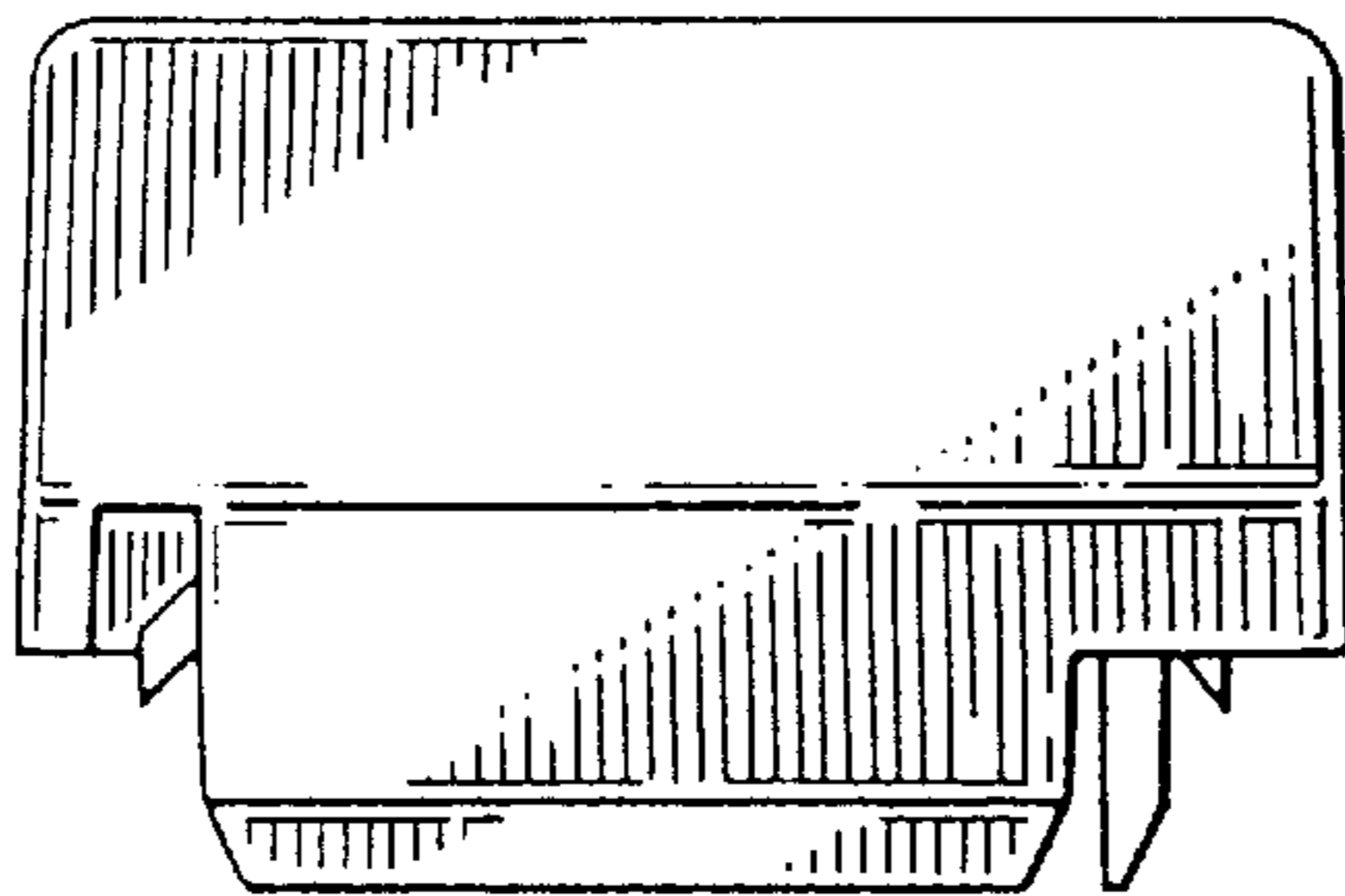

FIG. 5

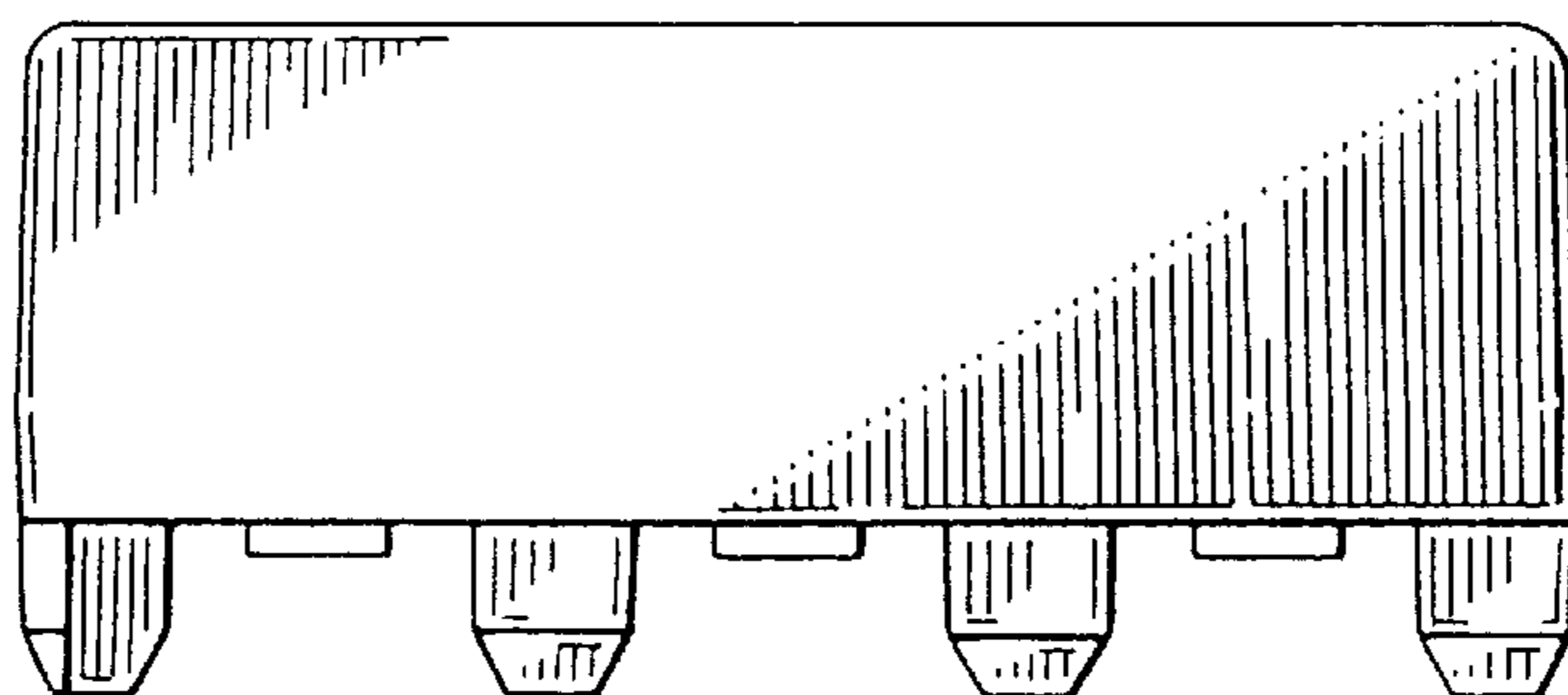

FIG. 6

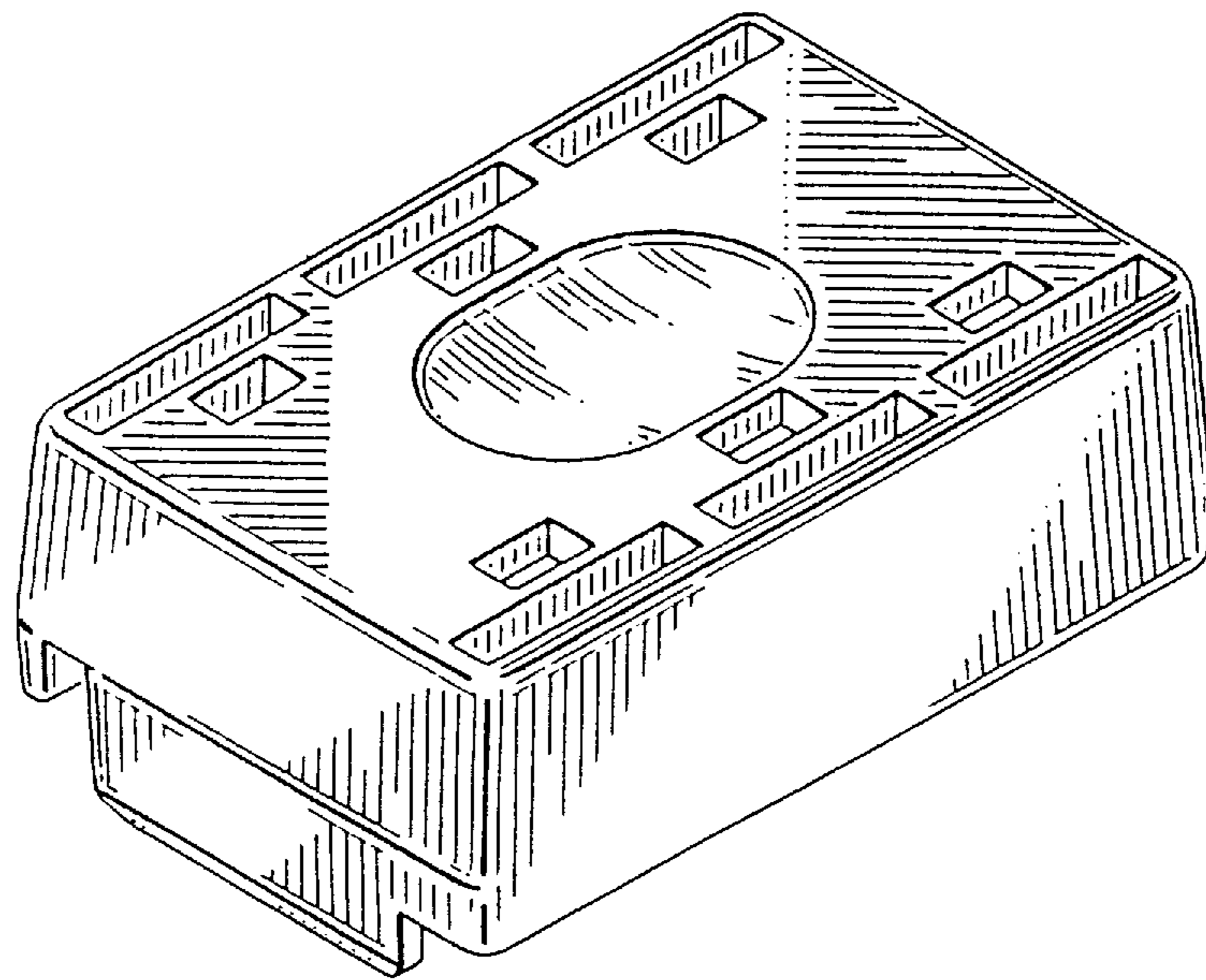

FIG. 7

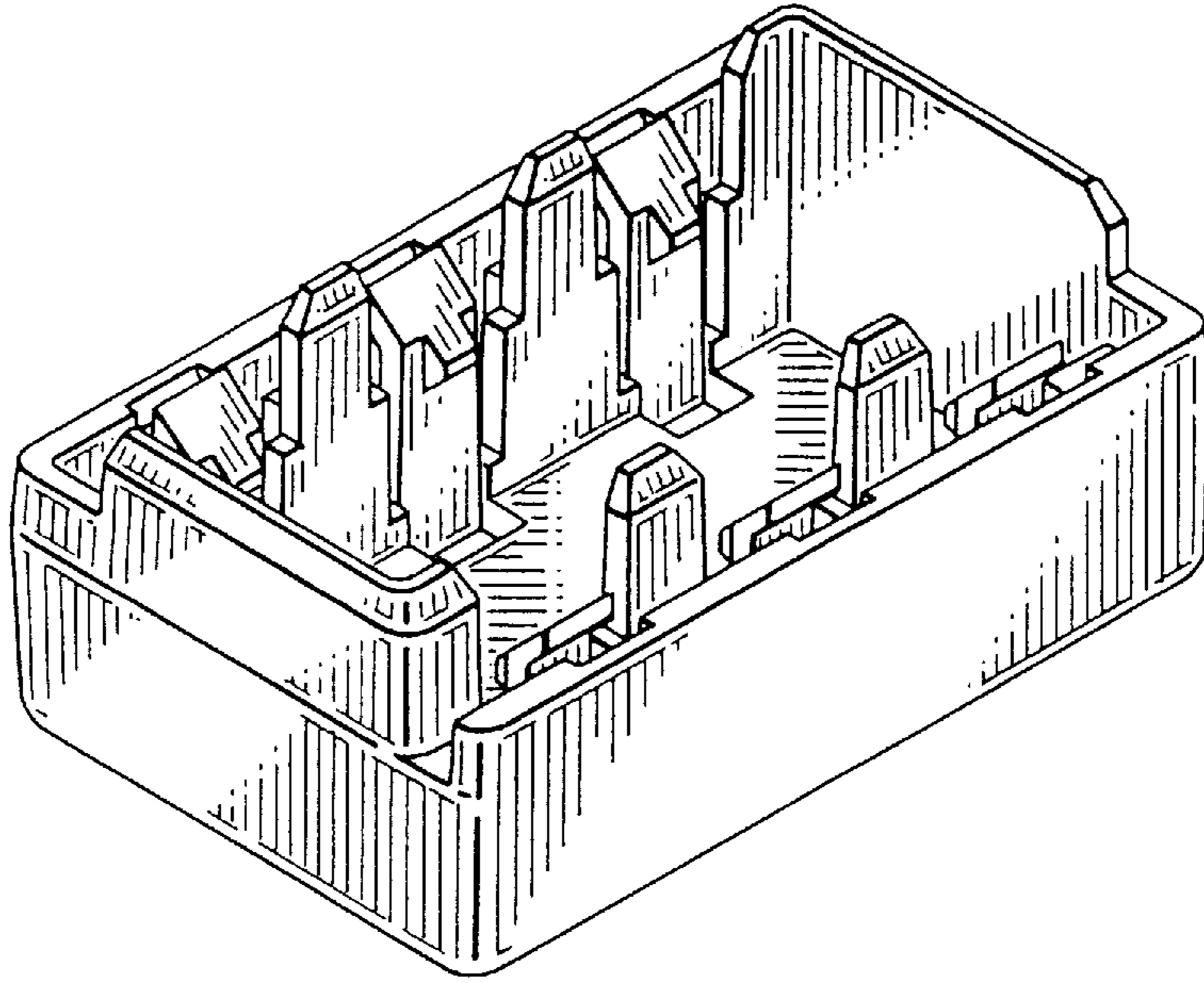

FIG. 9

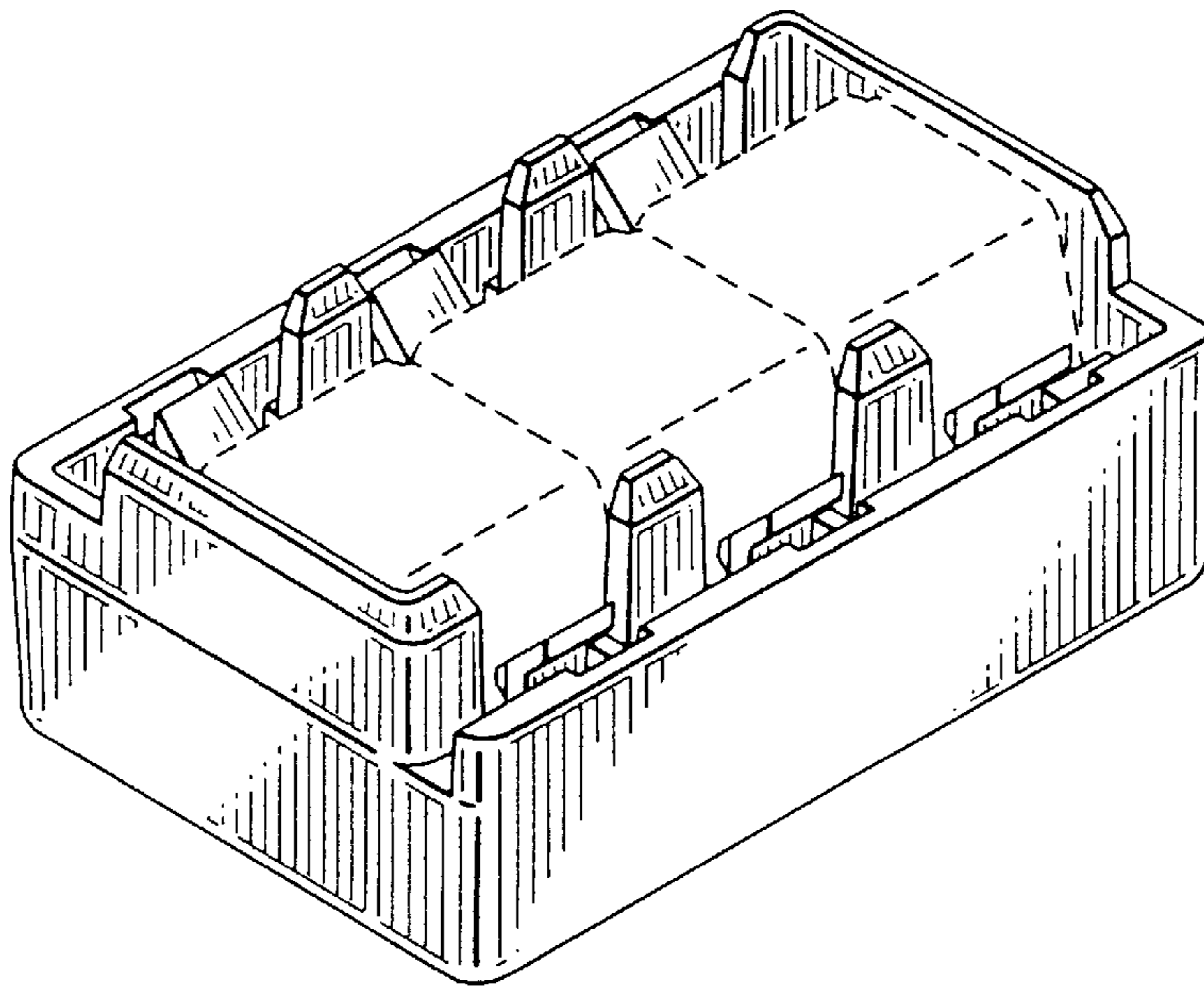

FIG. 8

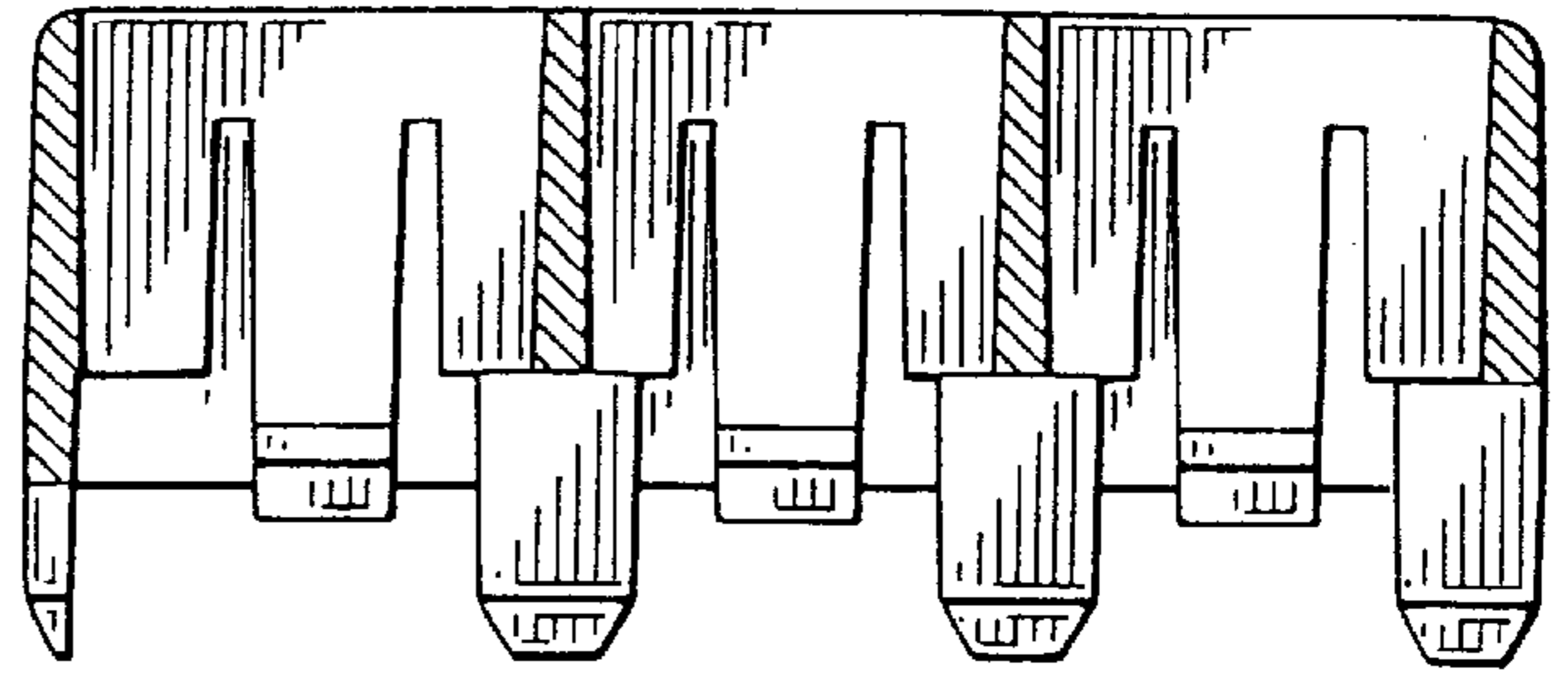

FIG. 10

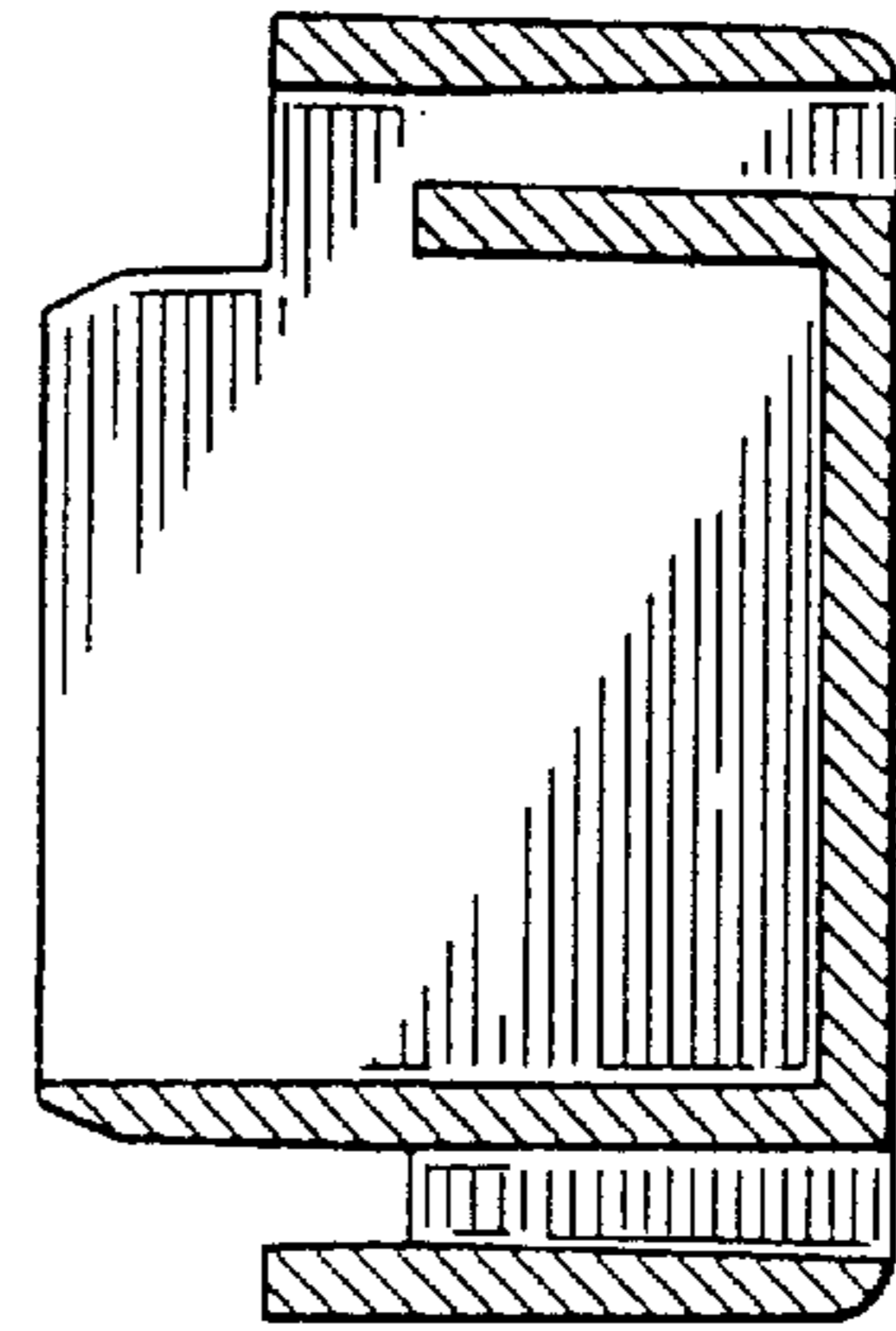

FIG. 11

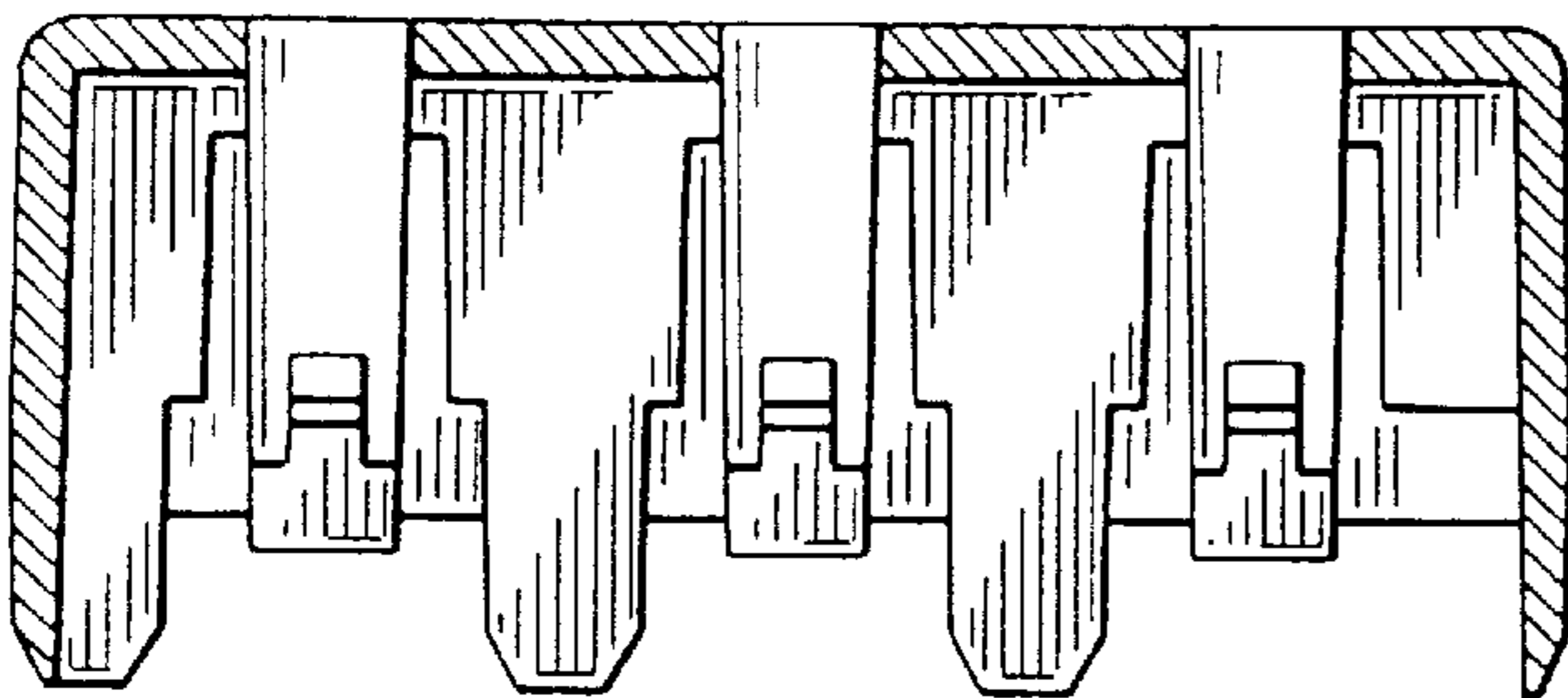

FIG. 12

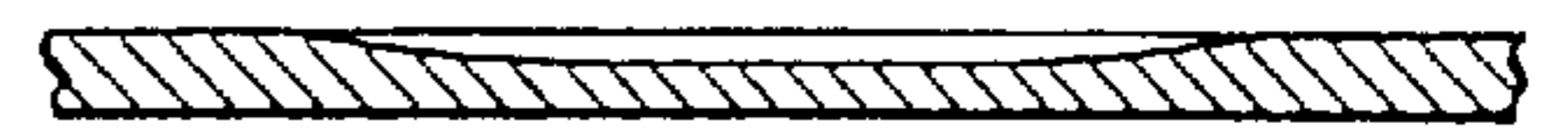

FIG. 13

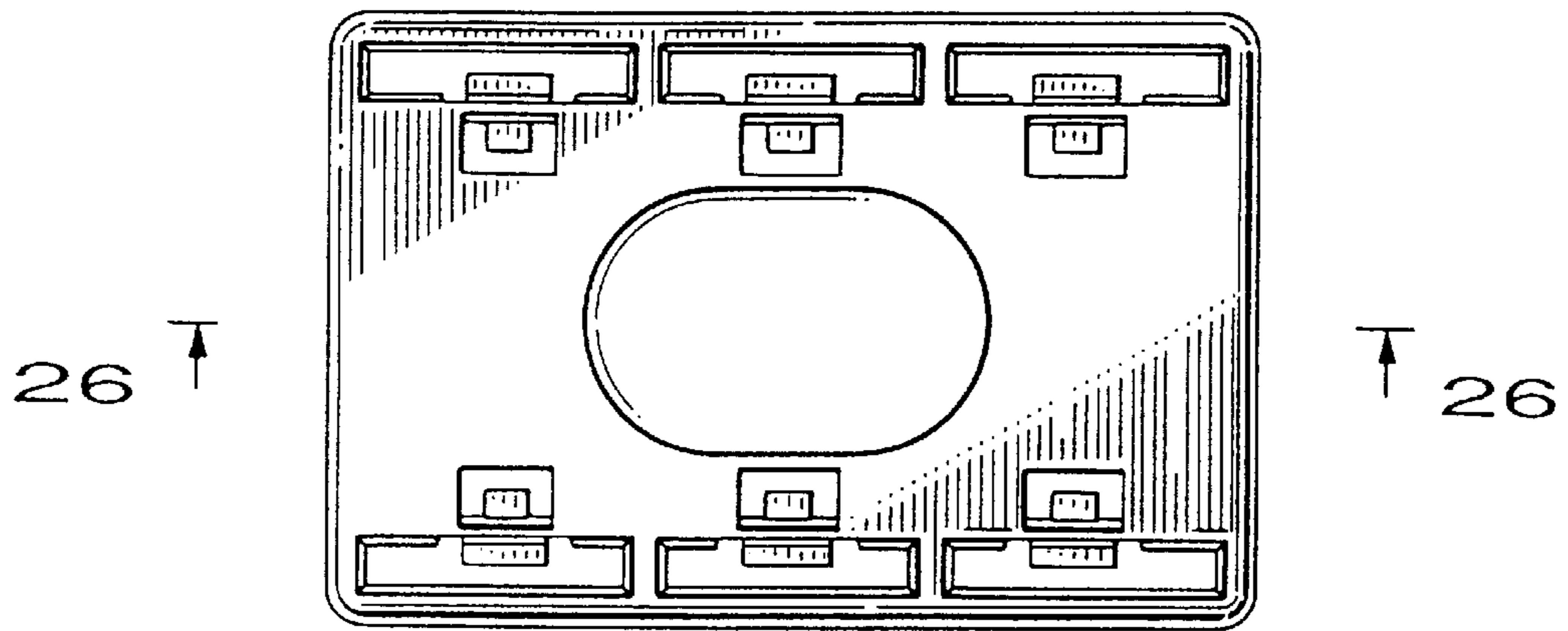

FIG. 14

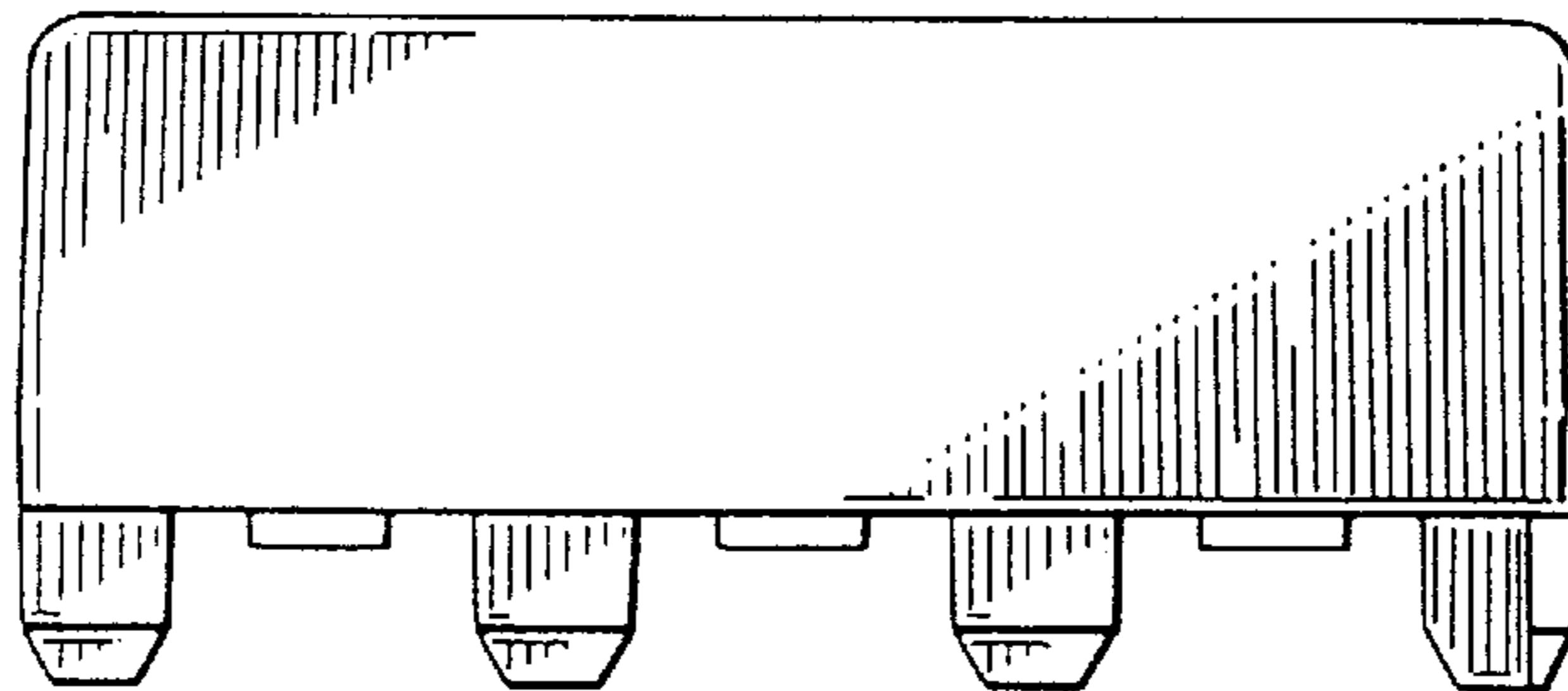

FIG. 15

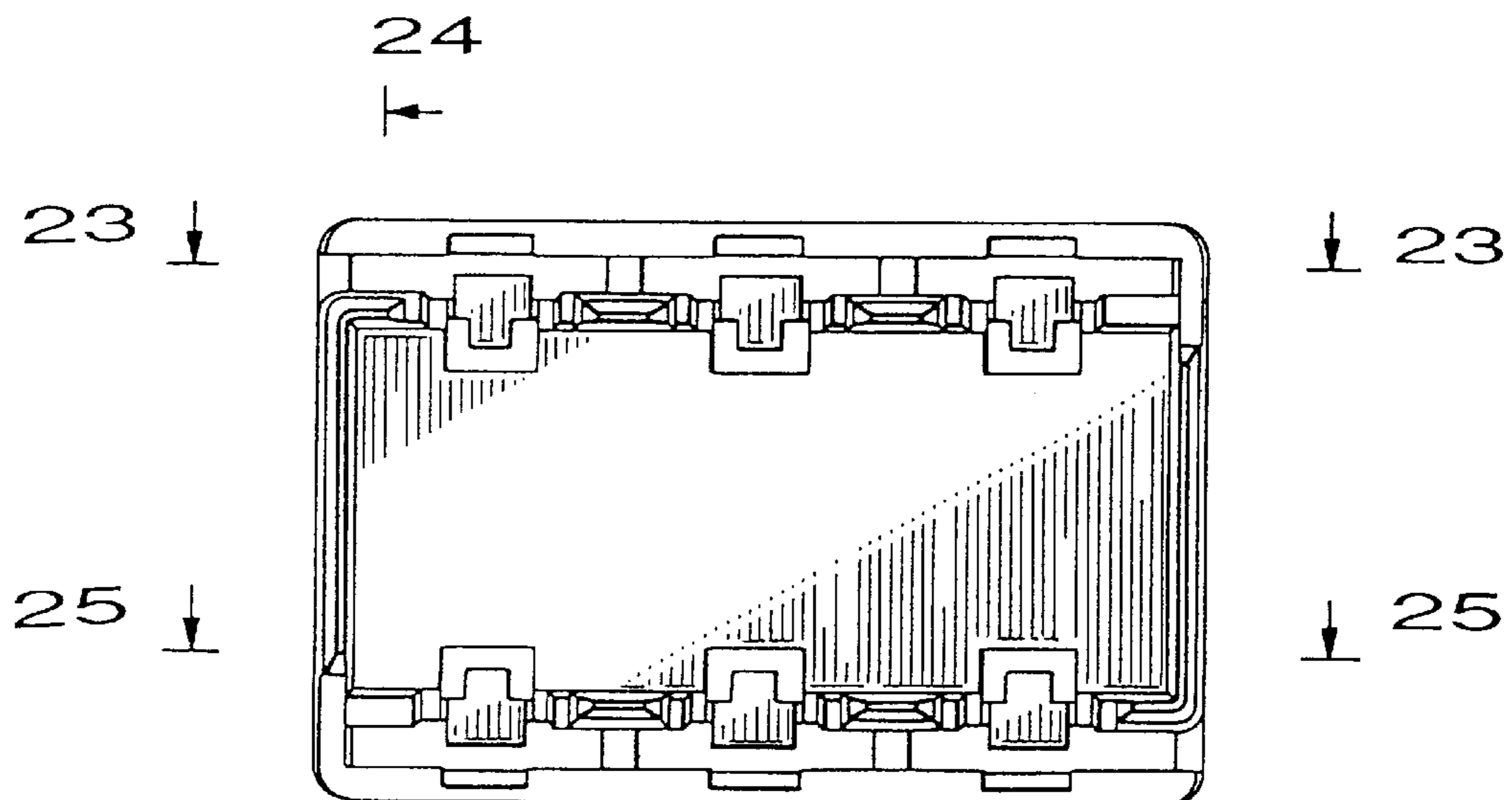

FIG. 16

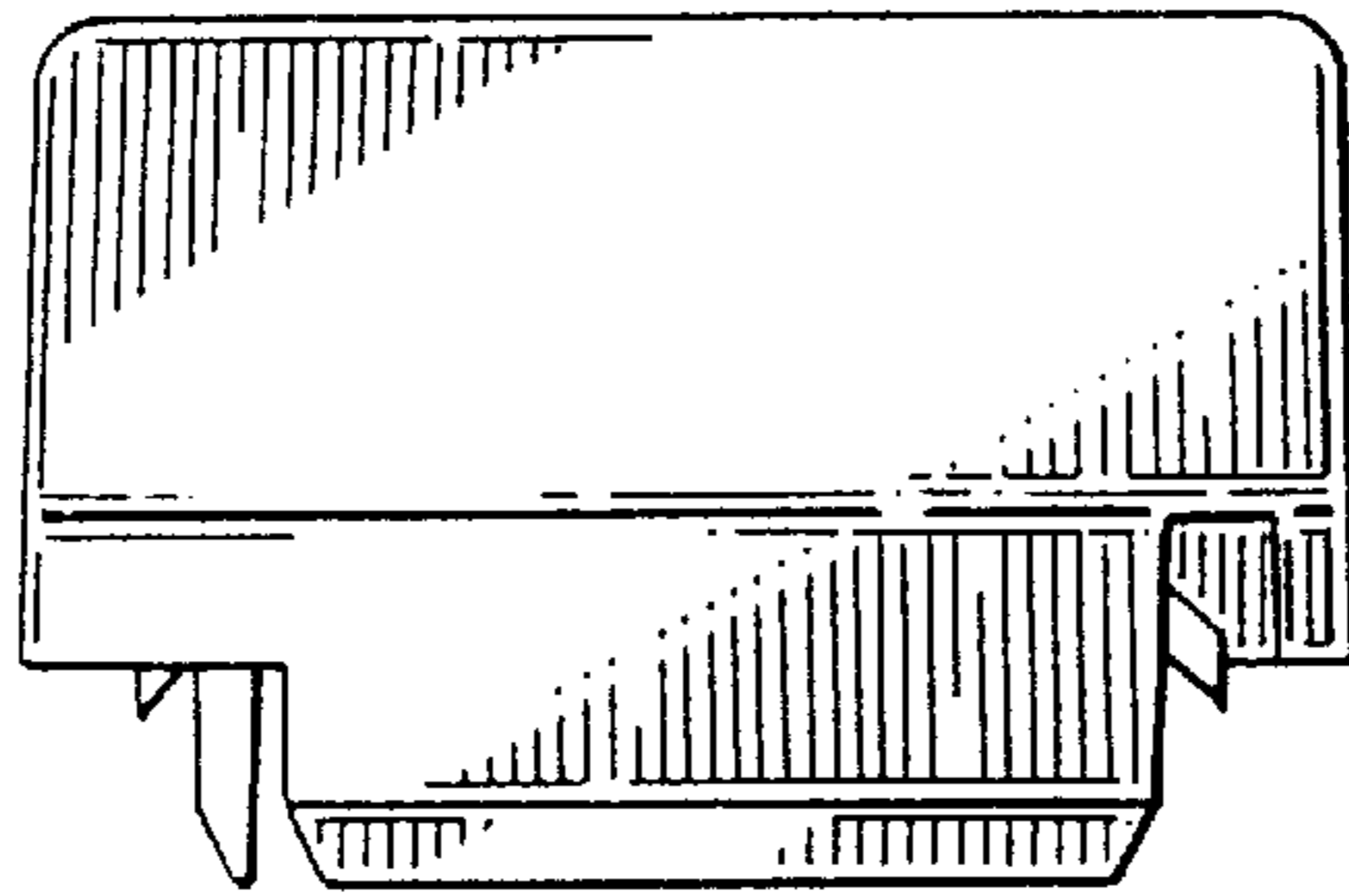

FIG. 17

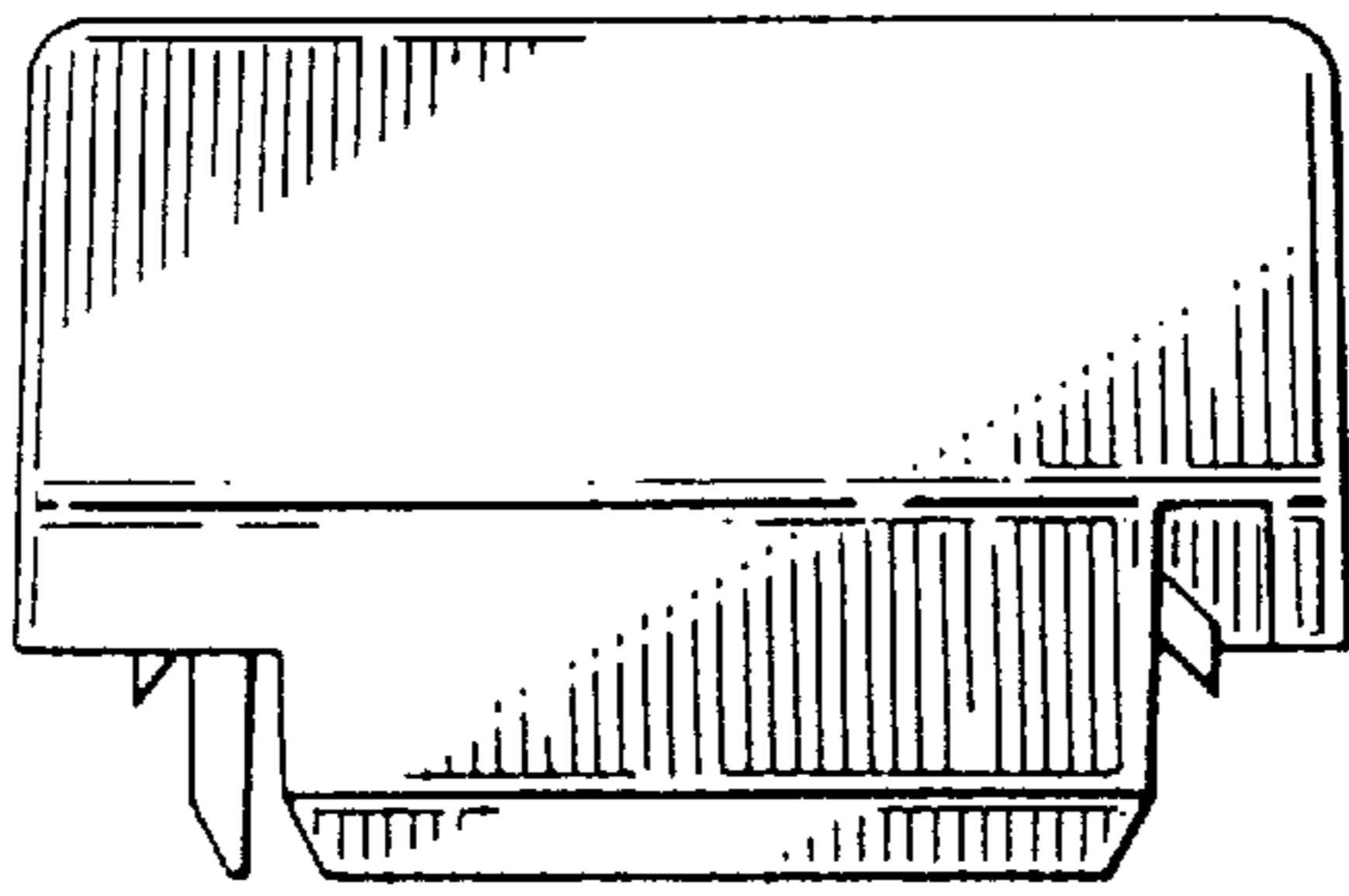

FIG. 18

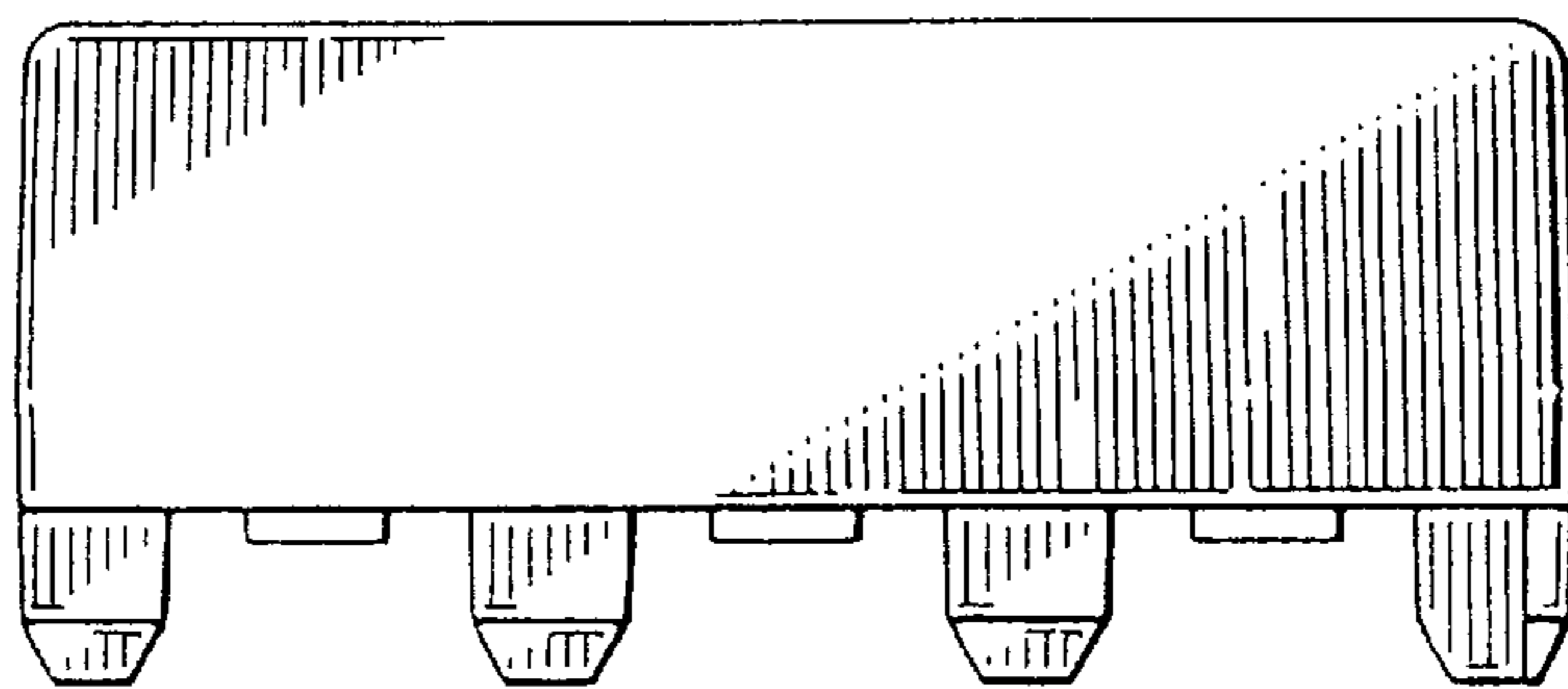

FIG. 19

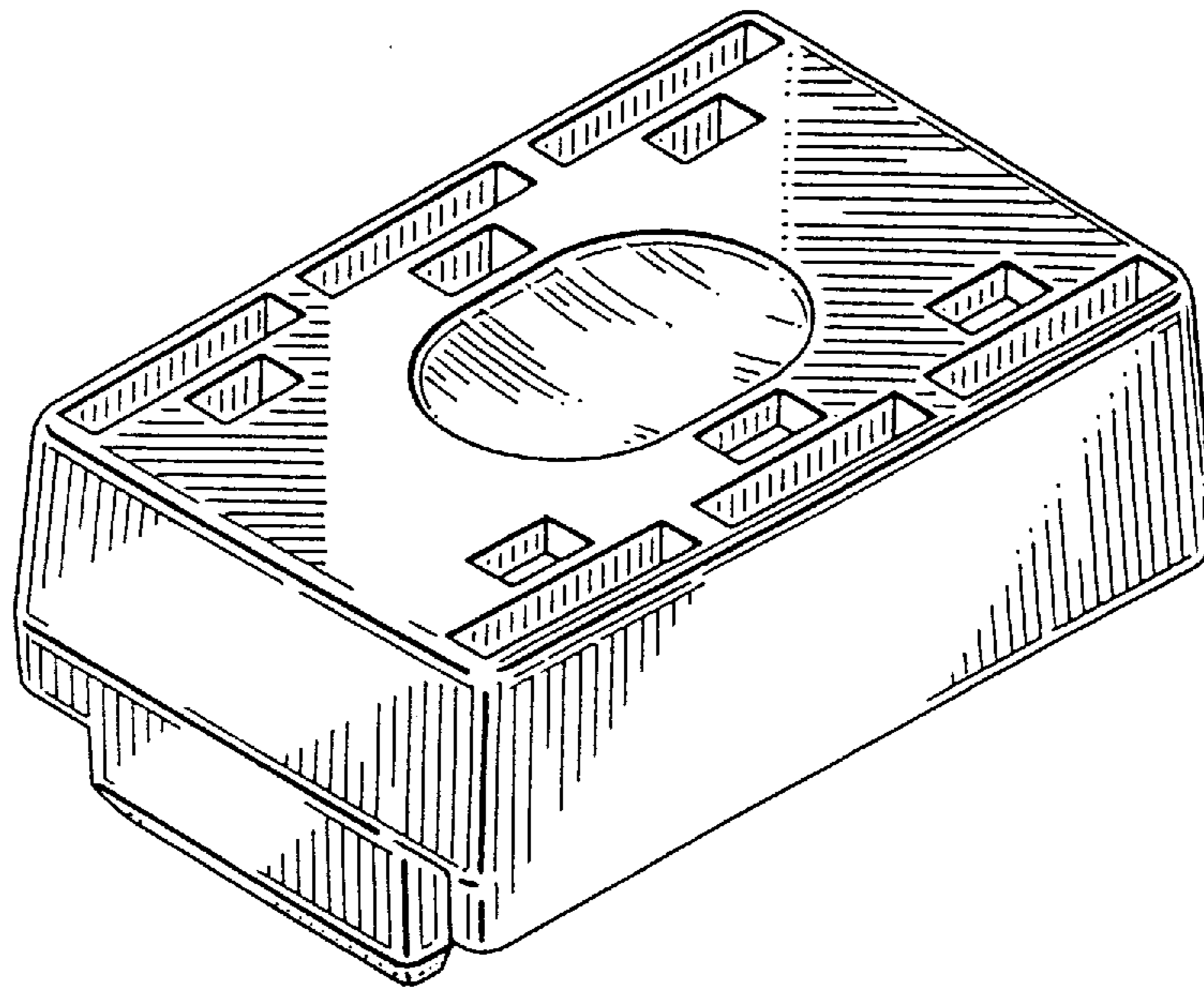

FIG. 20

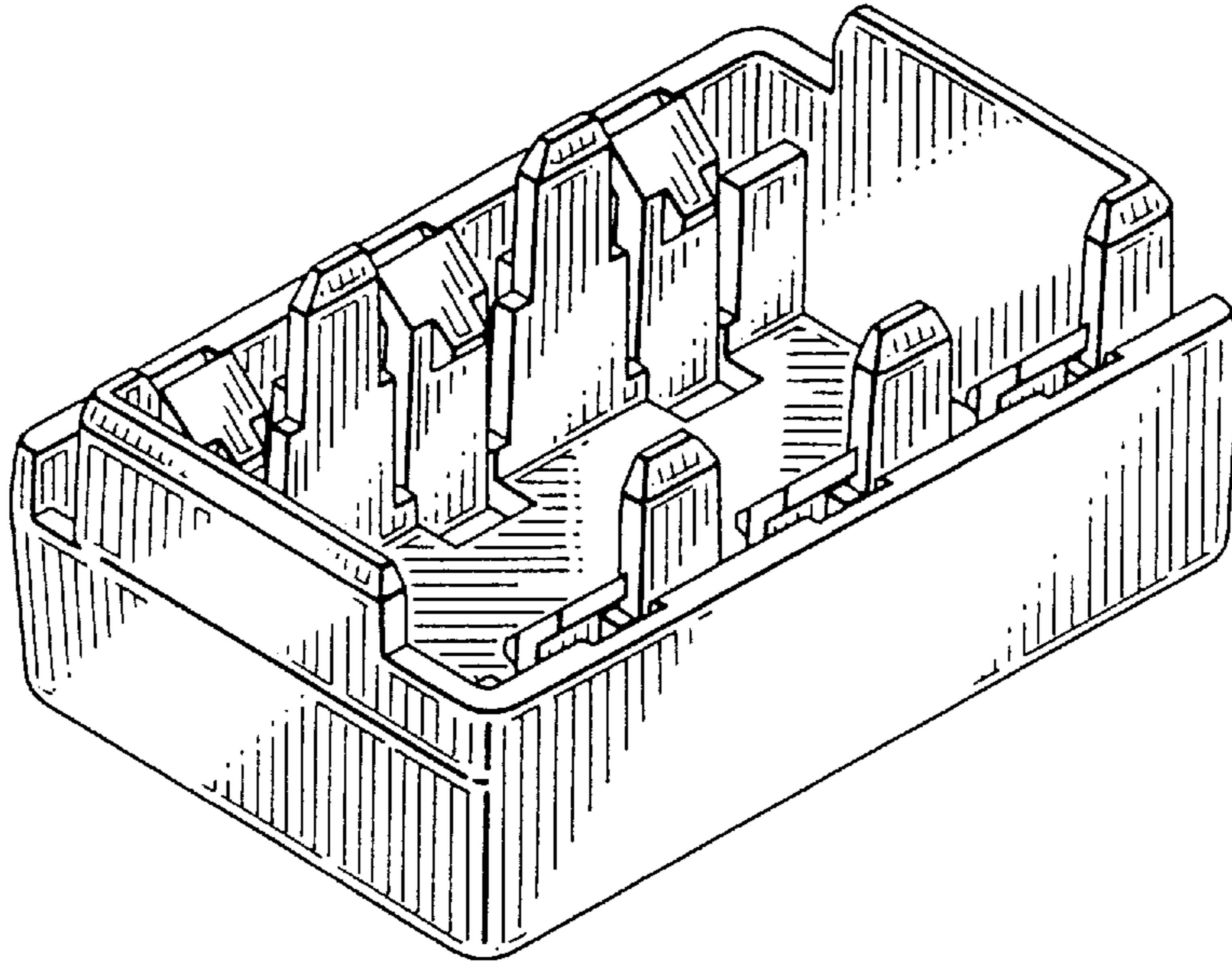

FIG. 22

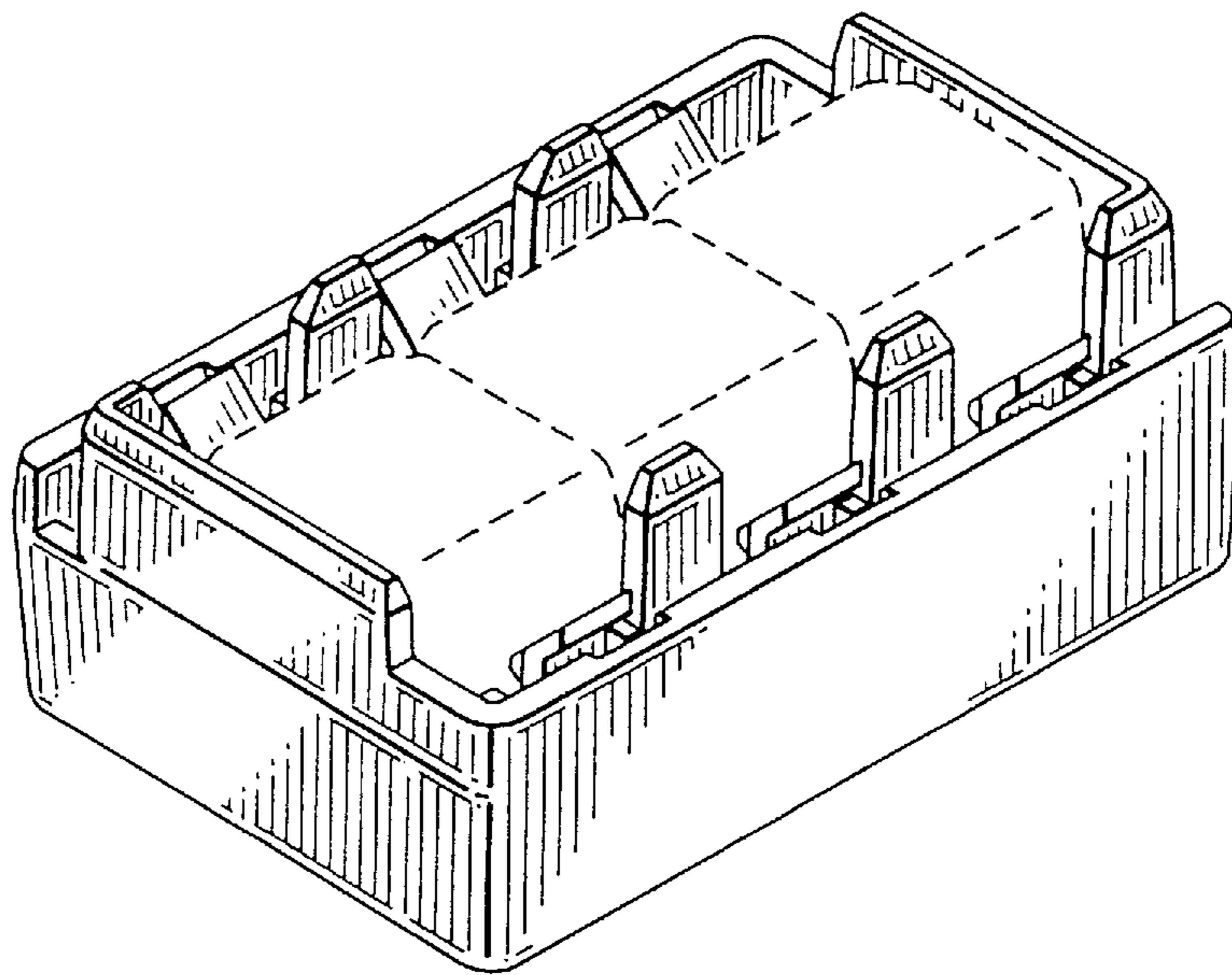

FIG. 21

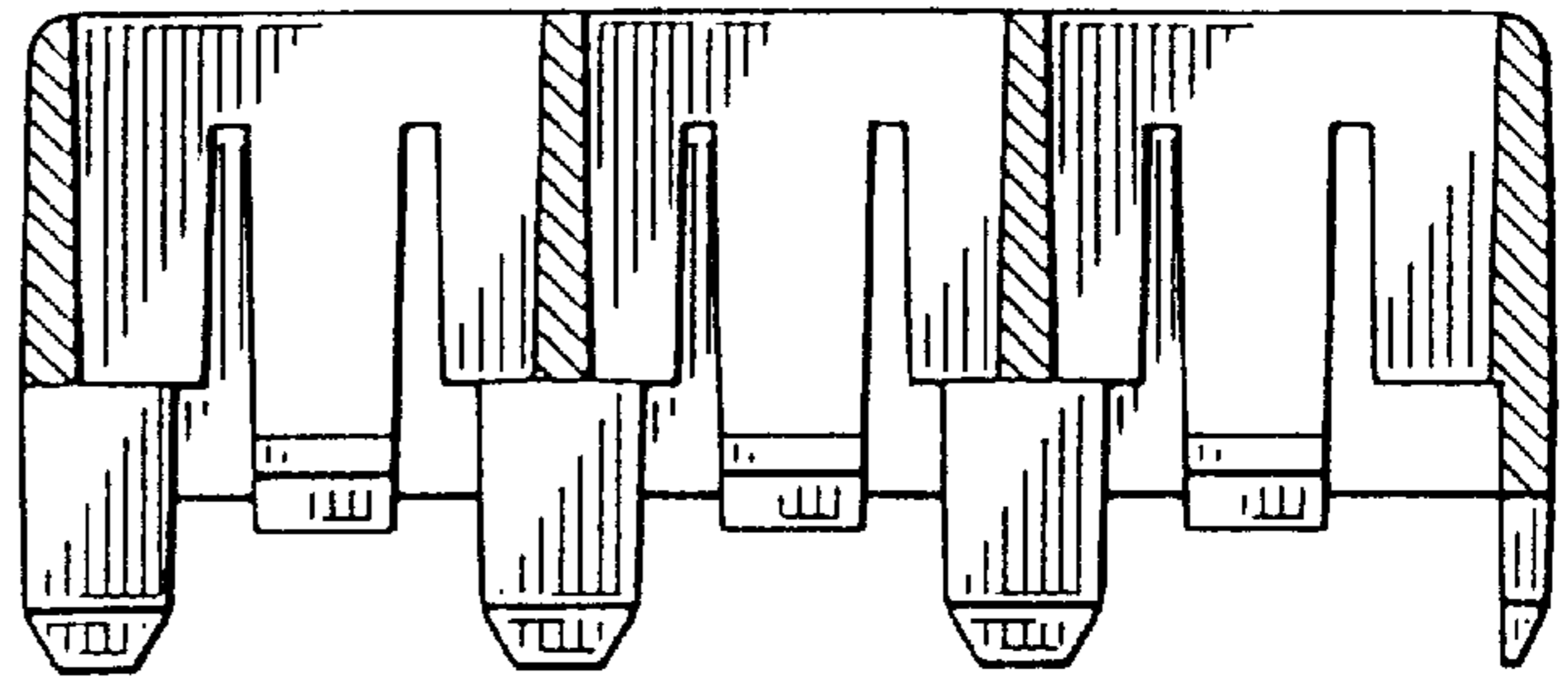

FIG. 23

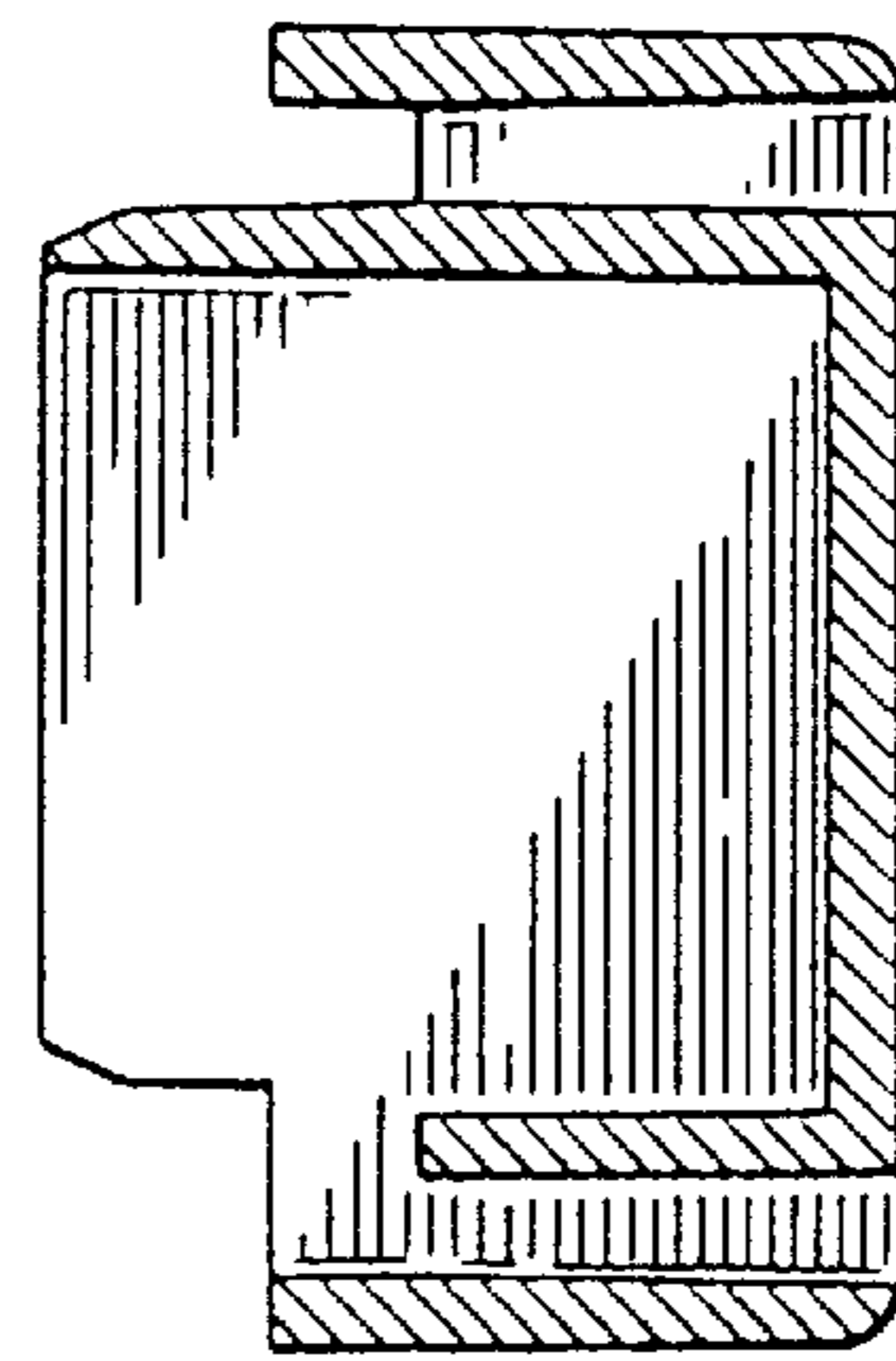

FIG. 24

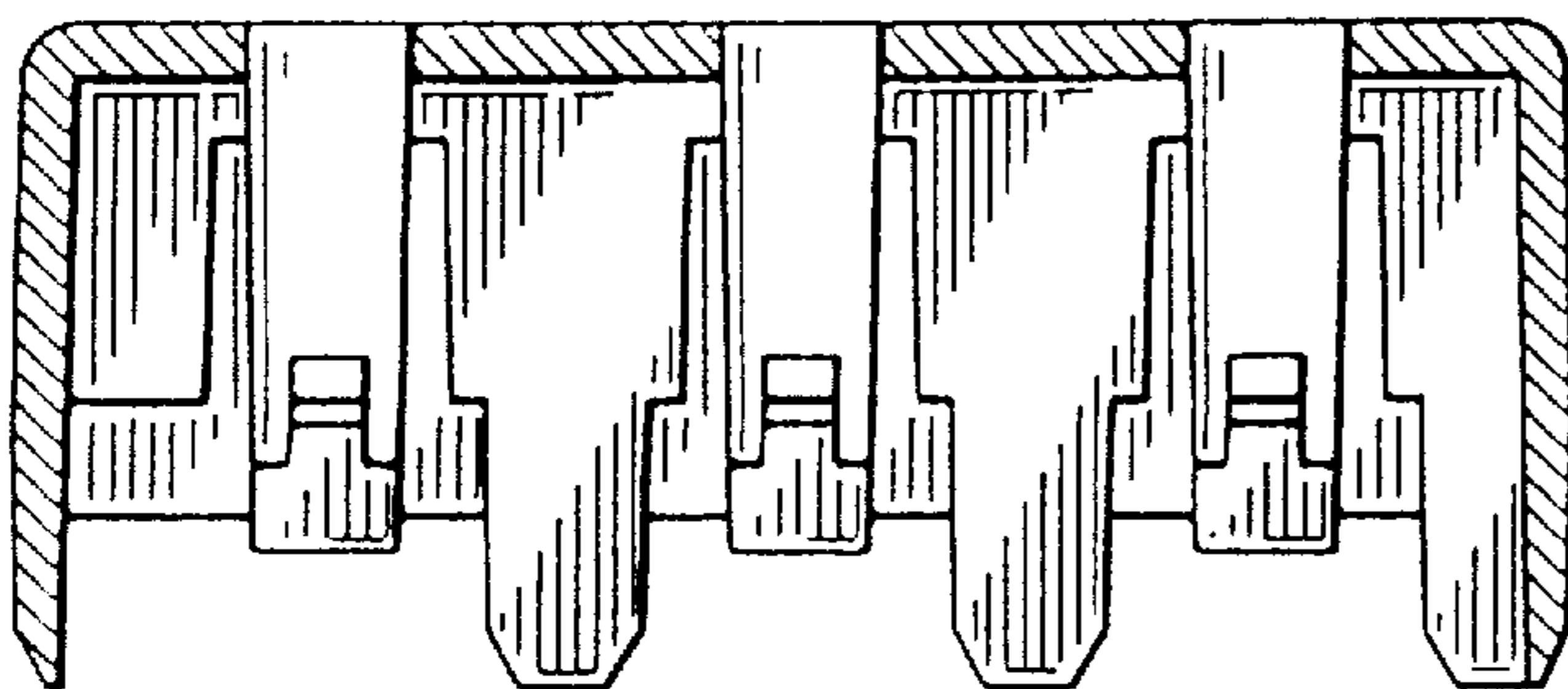

FIG. 25



FIG. 26

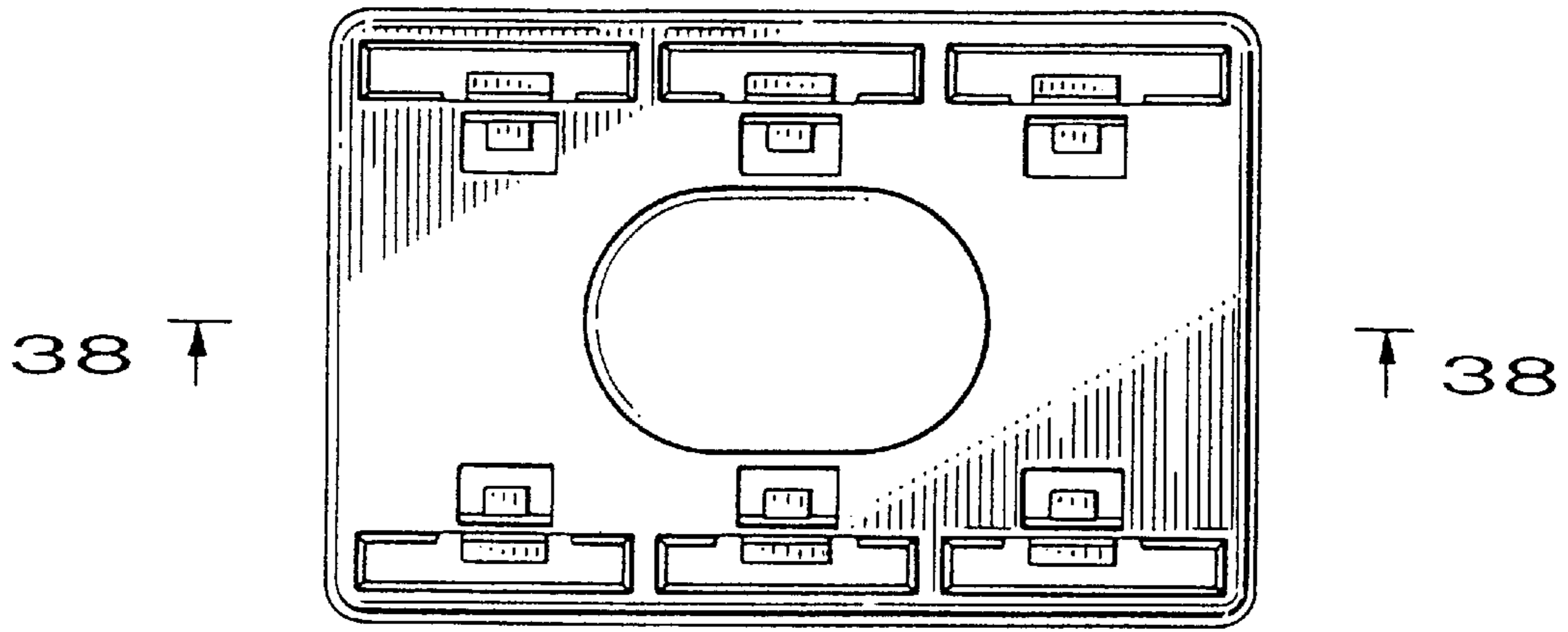

FIG. 27

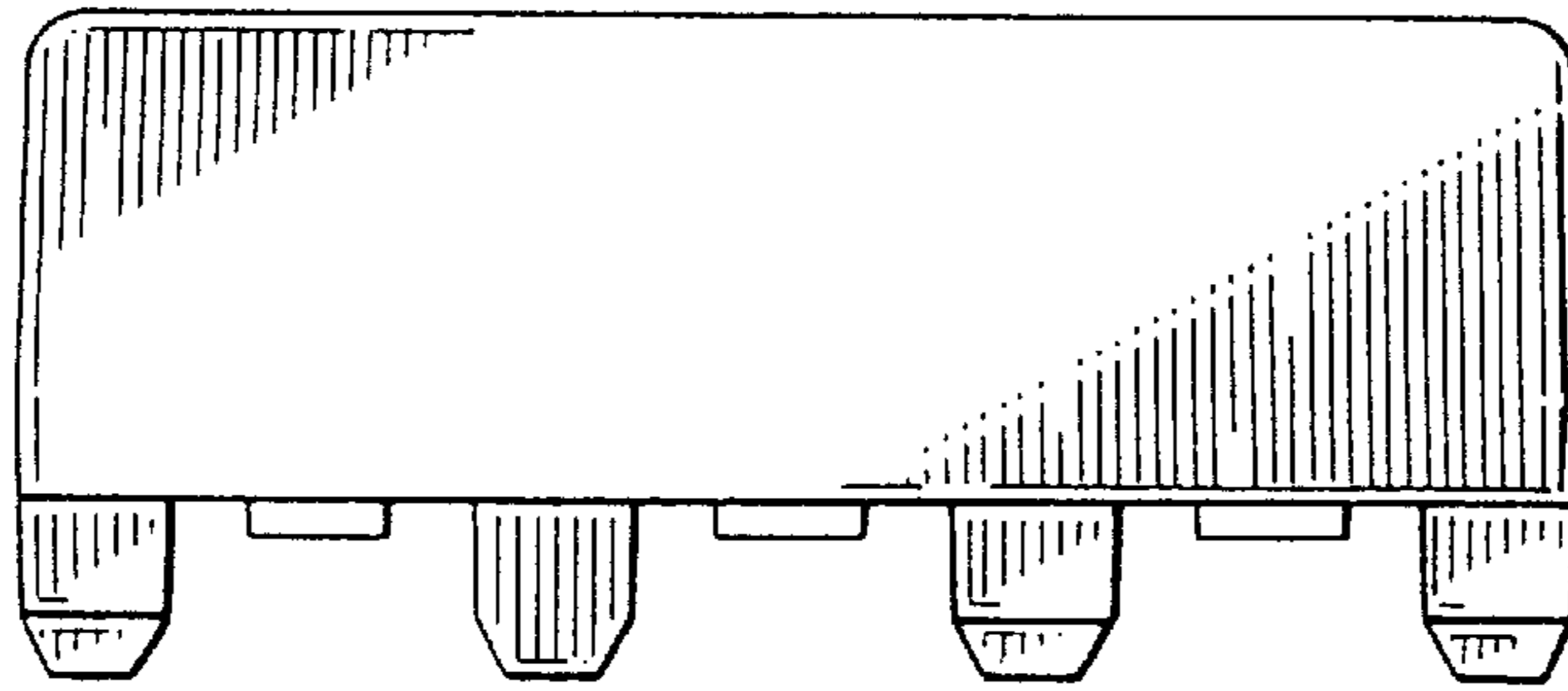

FIG. 28

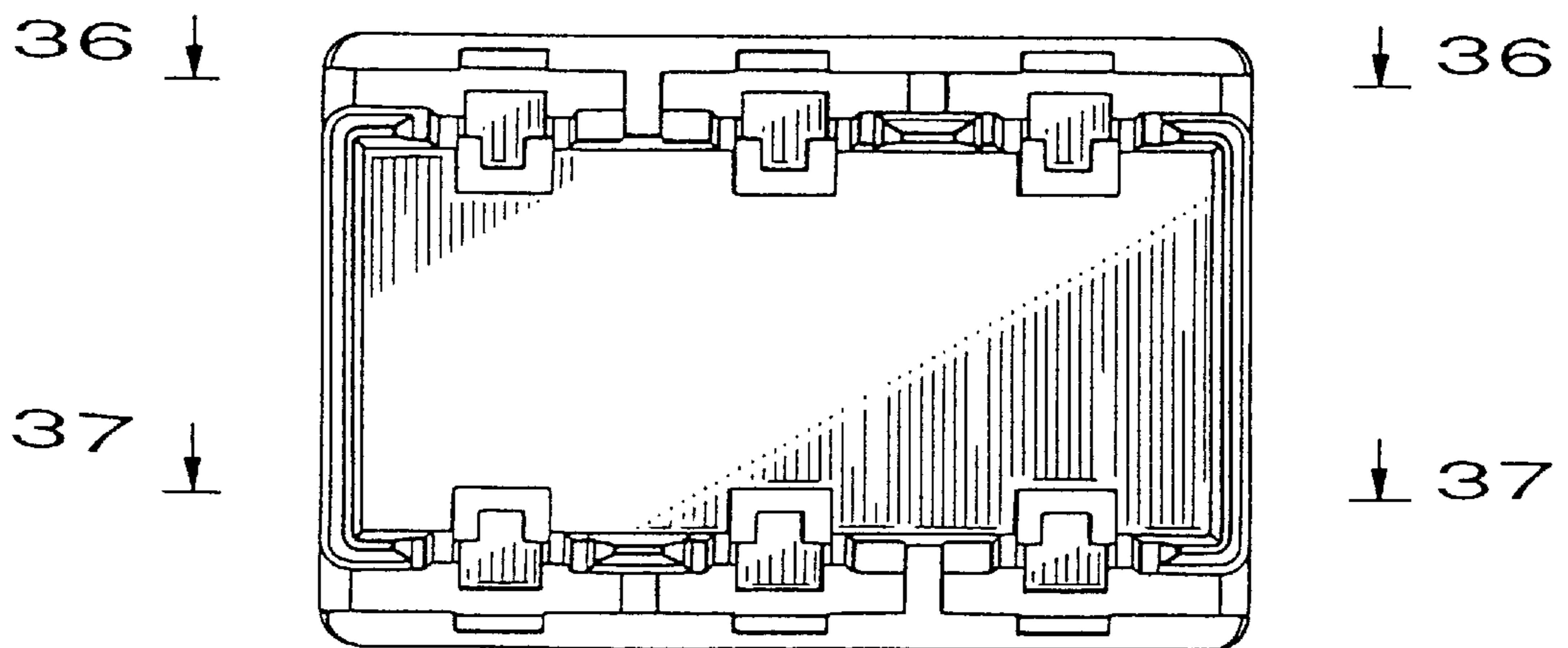

FIG. 29

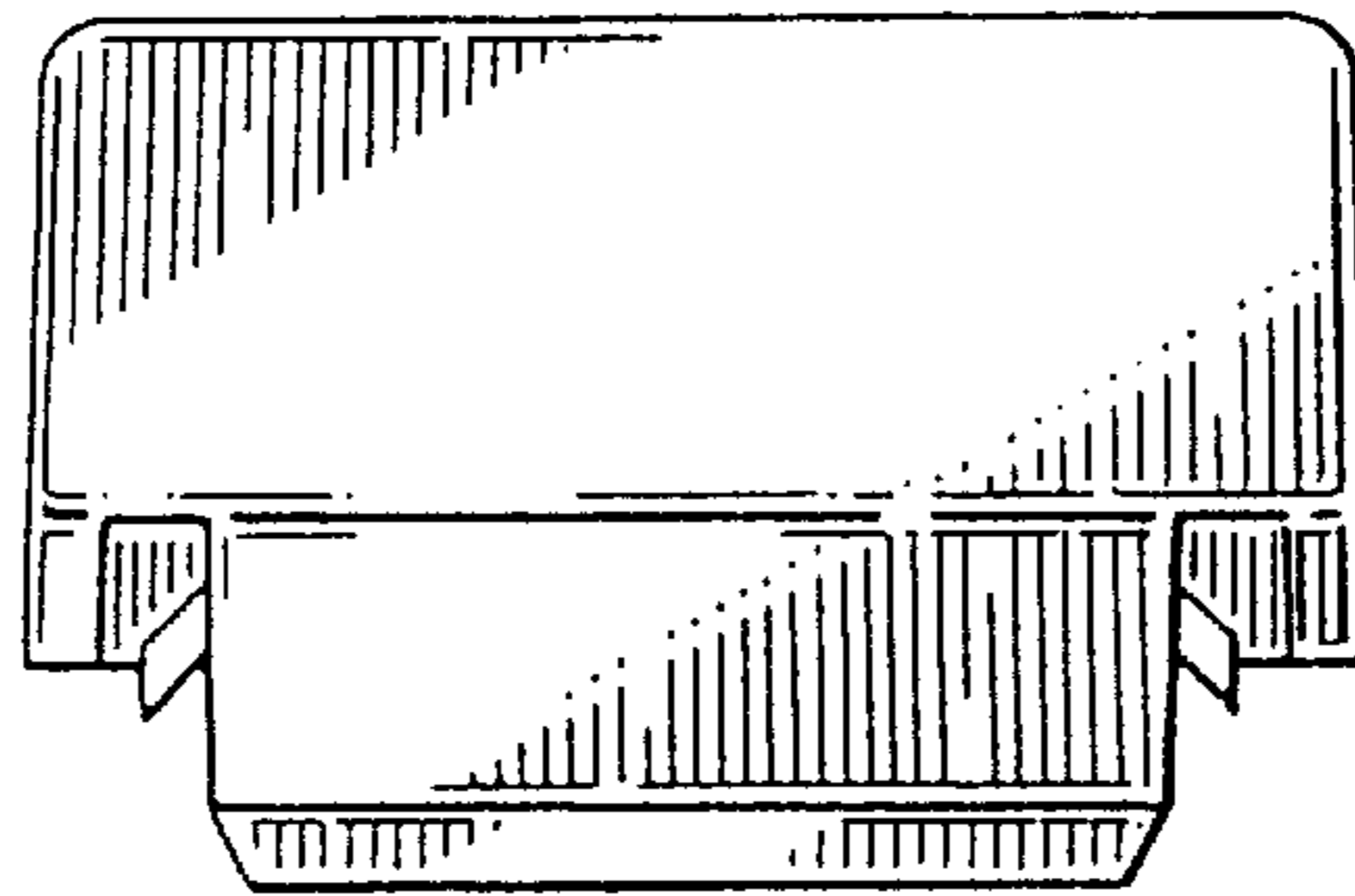

FIG. 30

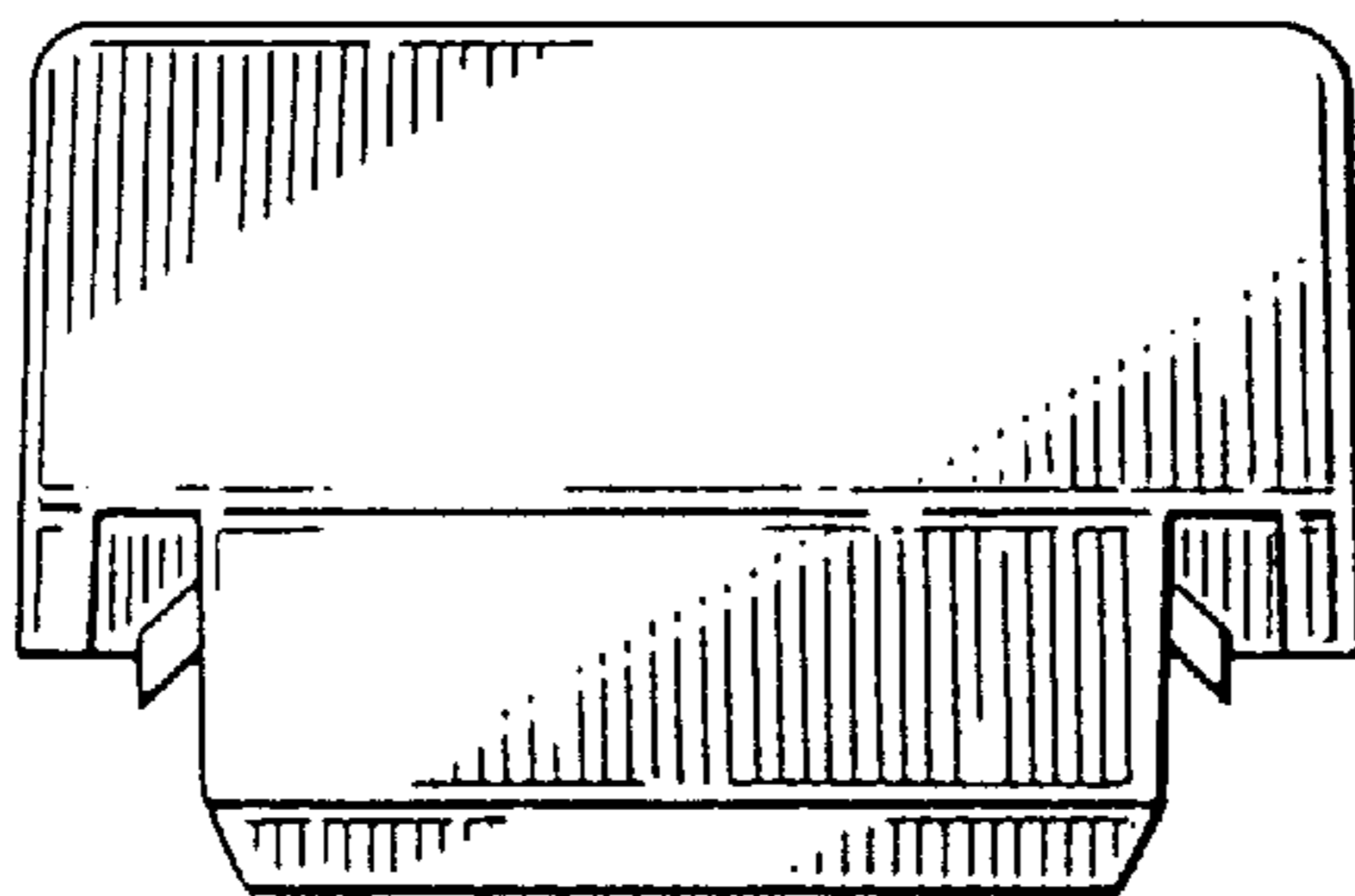

FIG. 31

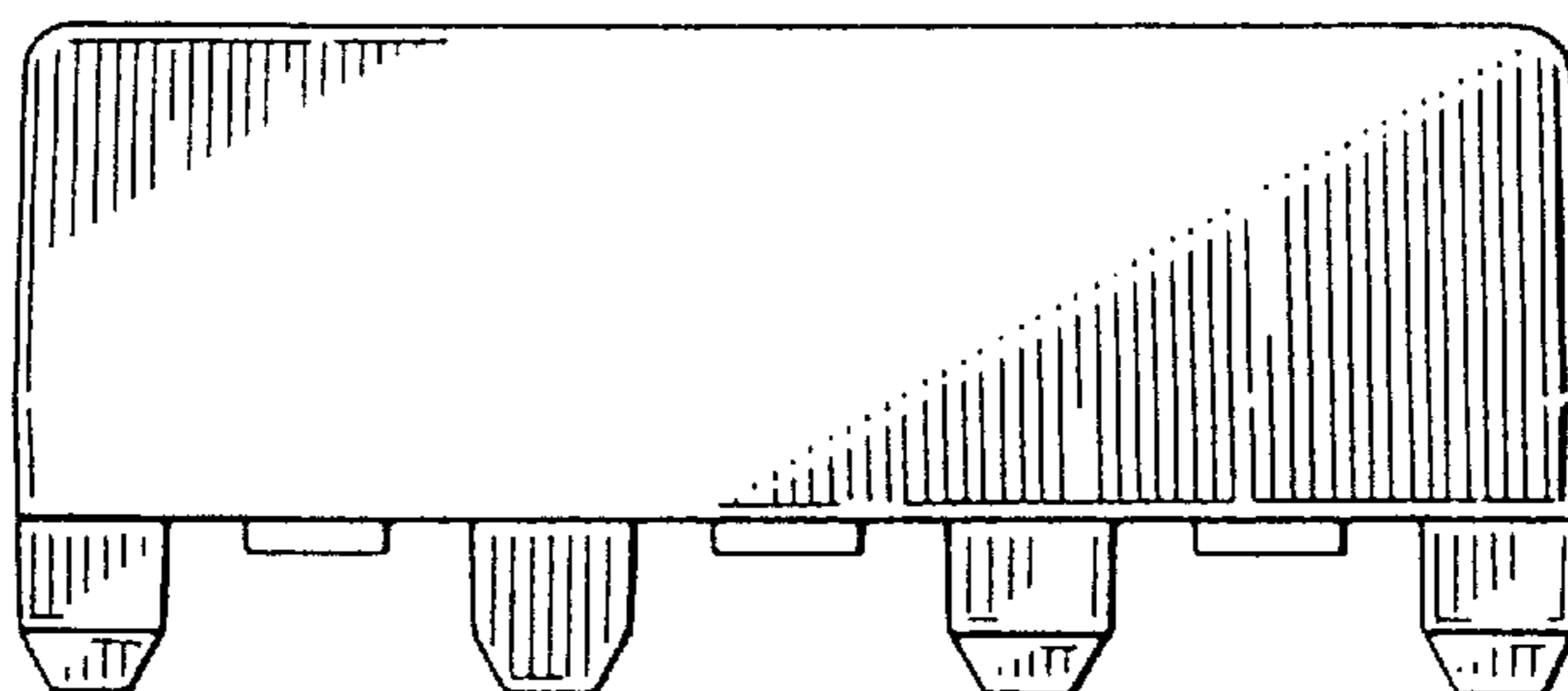

FIG. 32

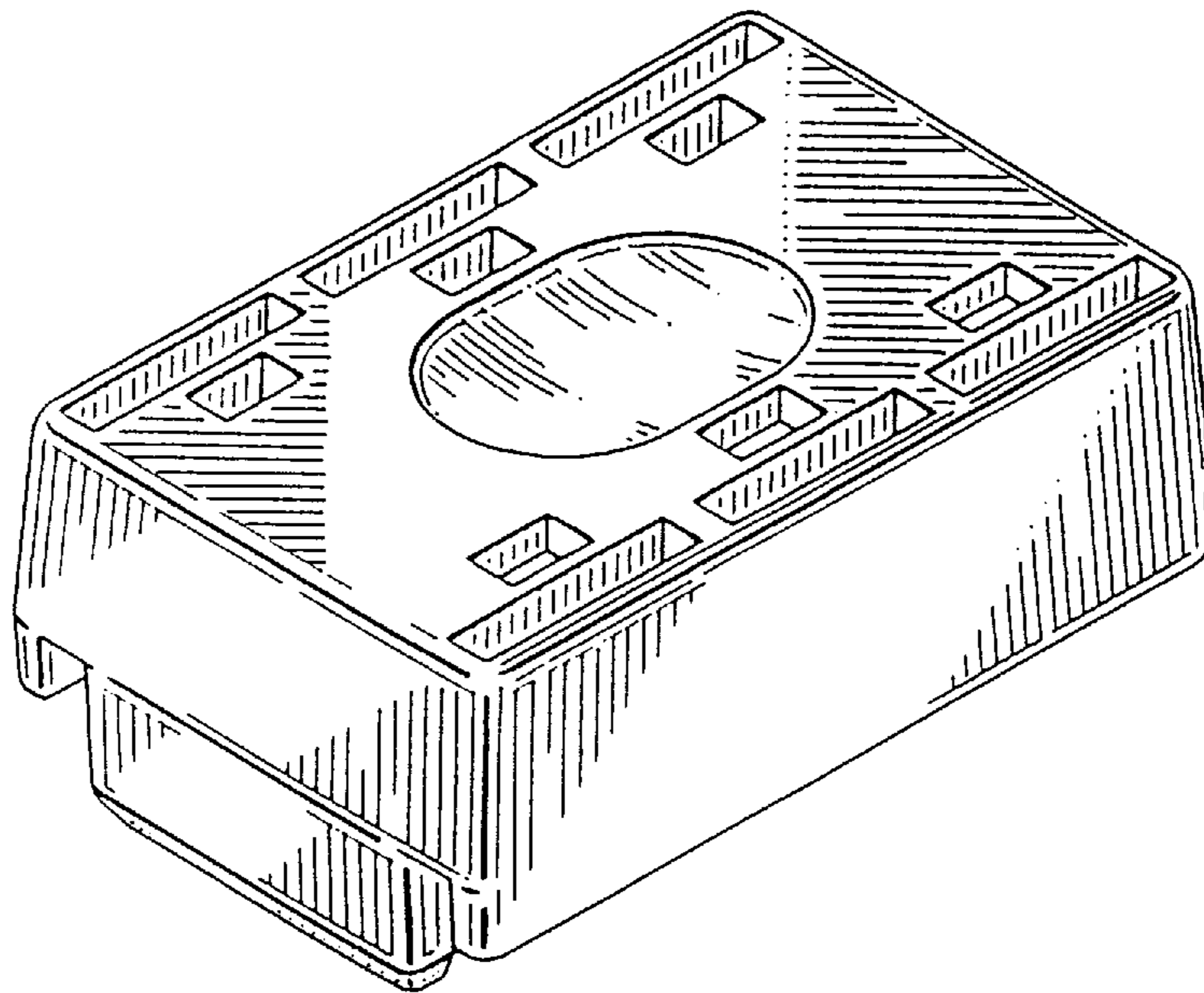

FIG. 33

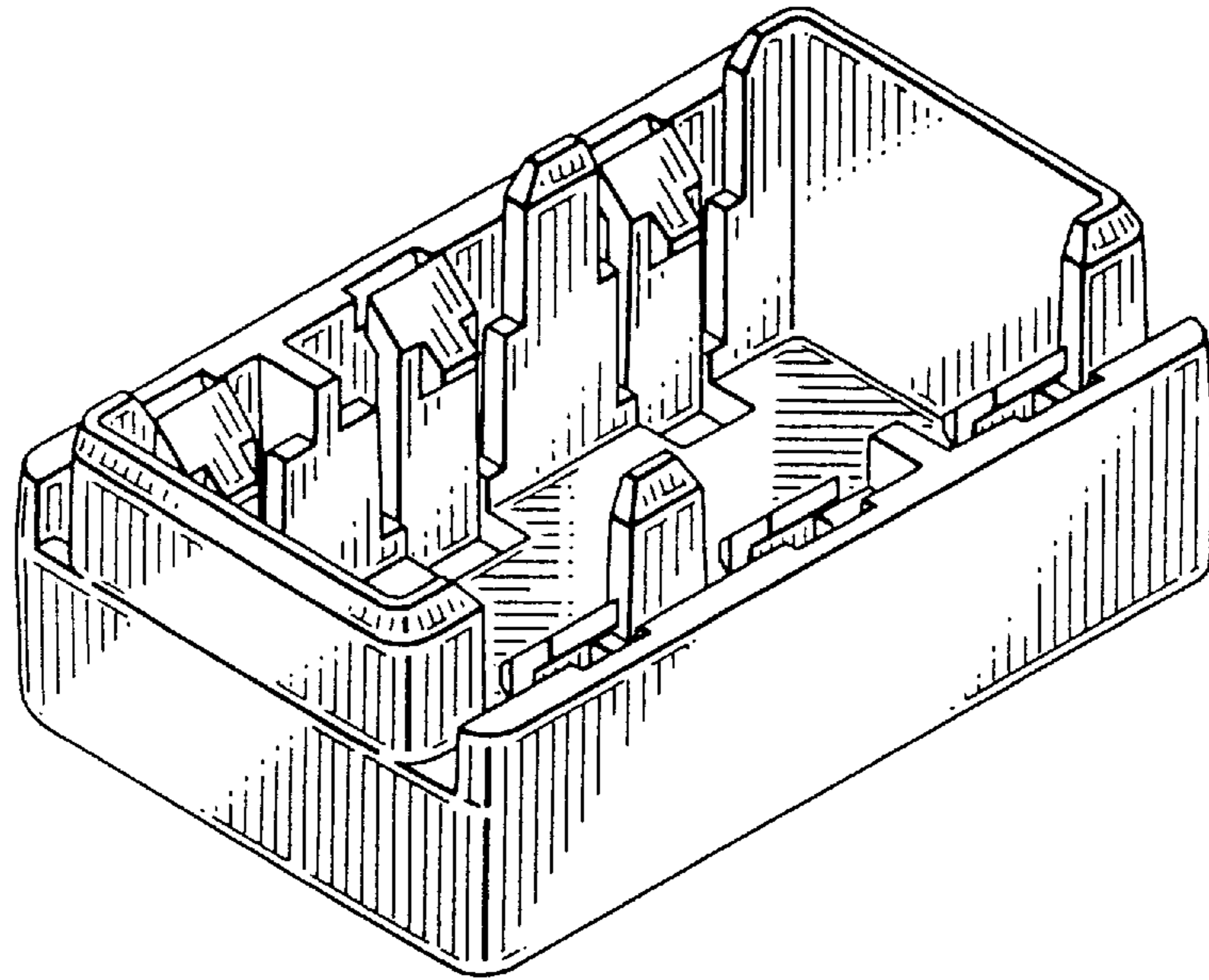

FIG. 35

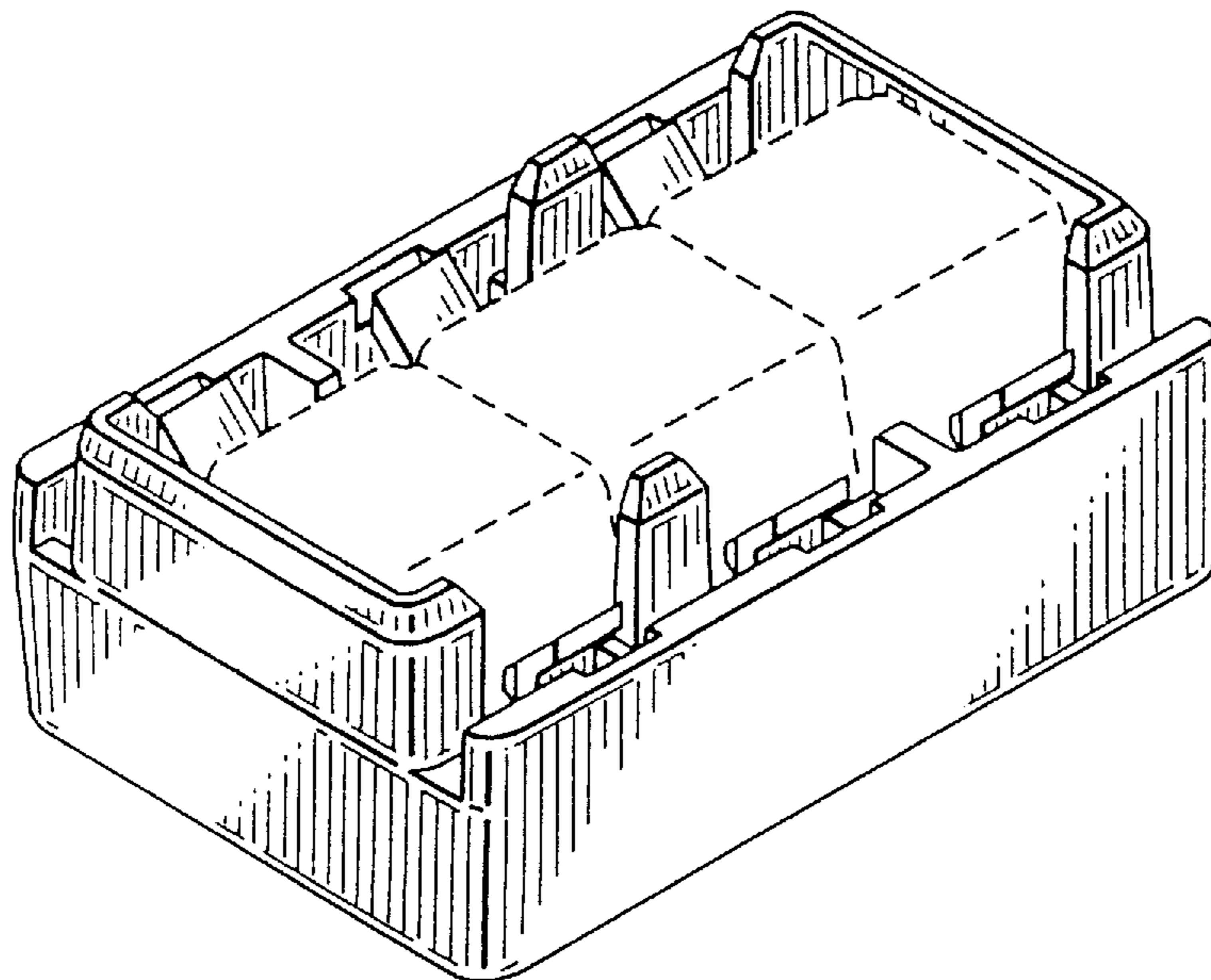

FIG. 34

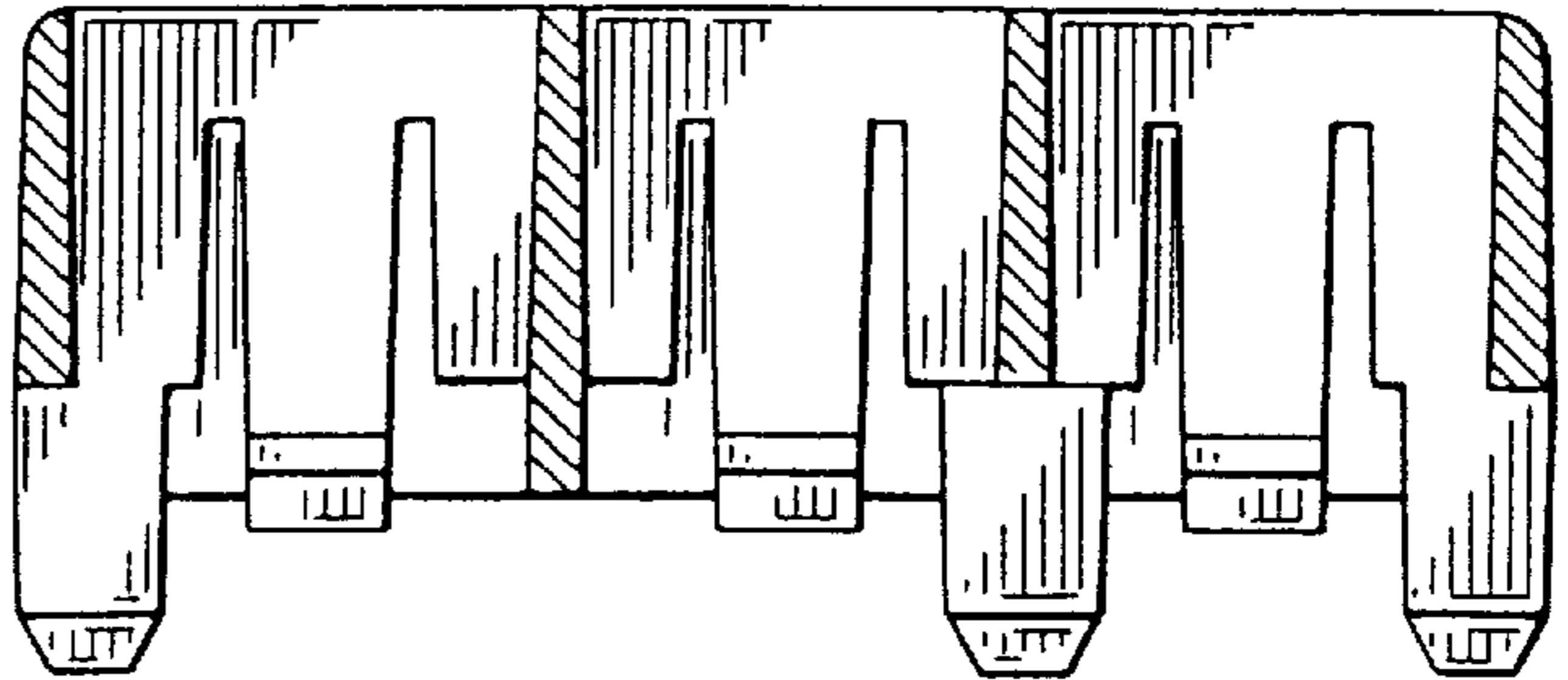

FIG. 36

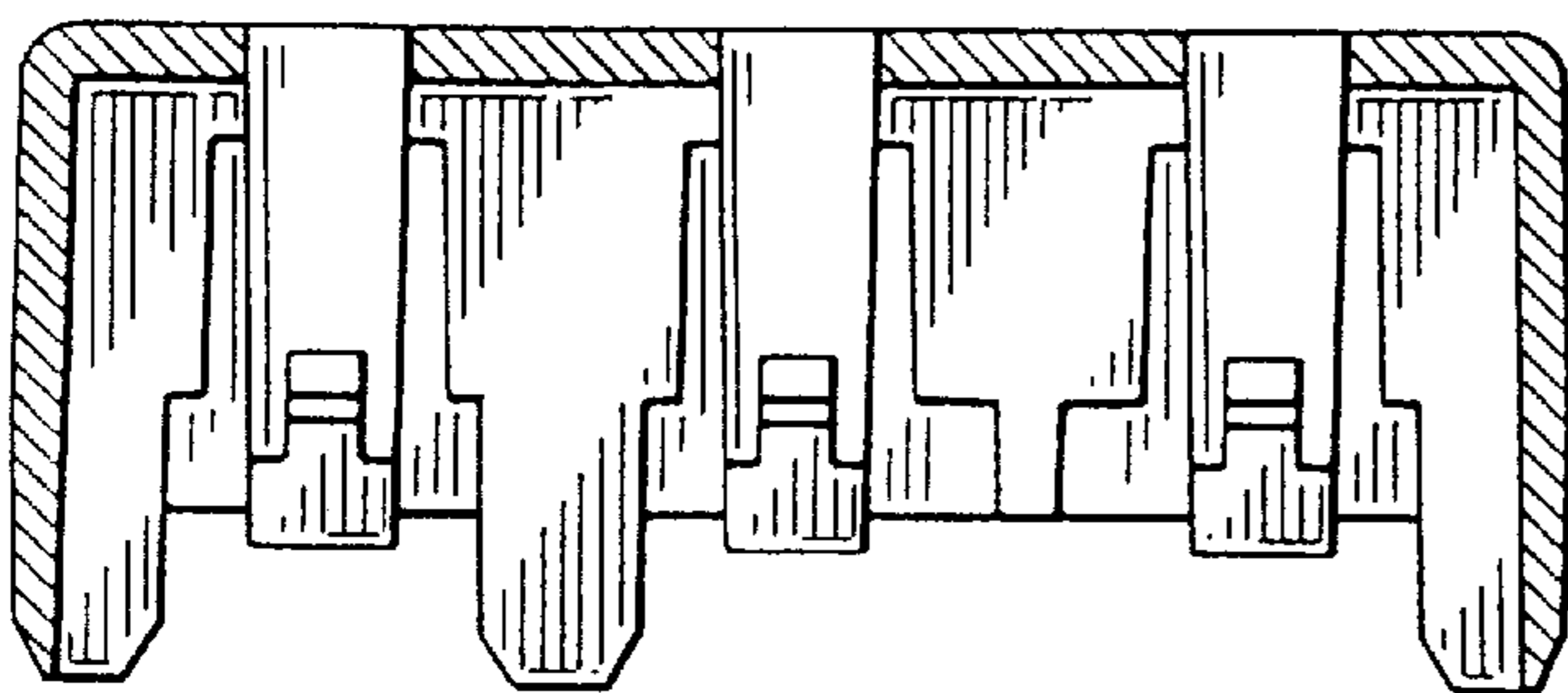
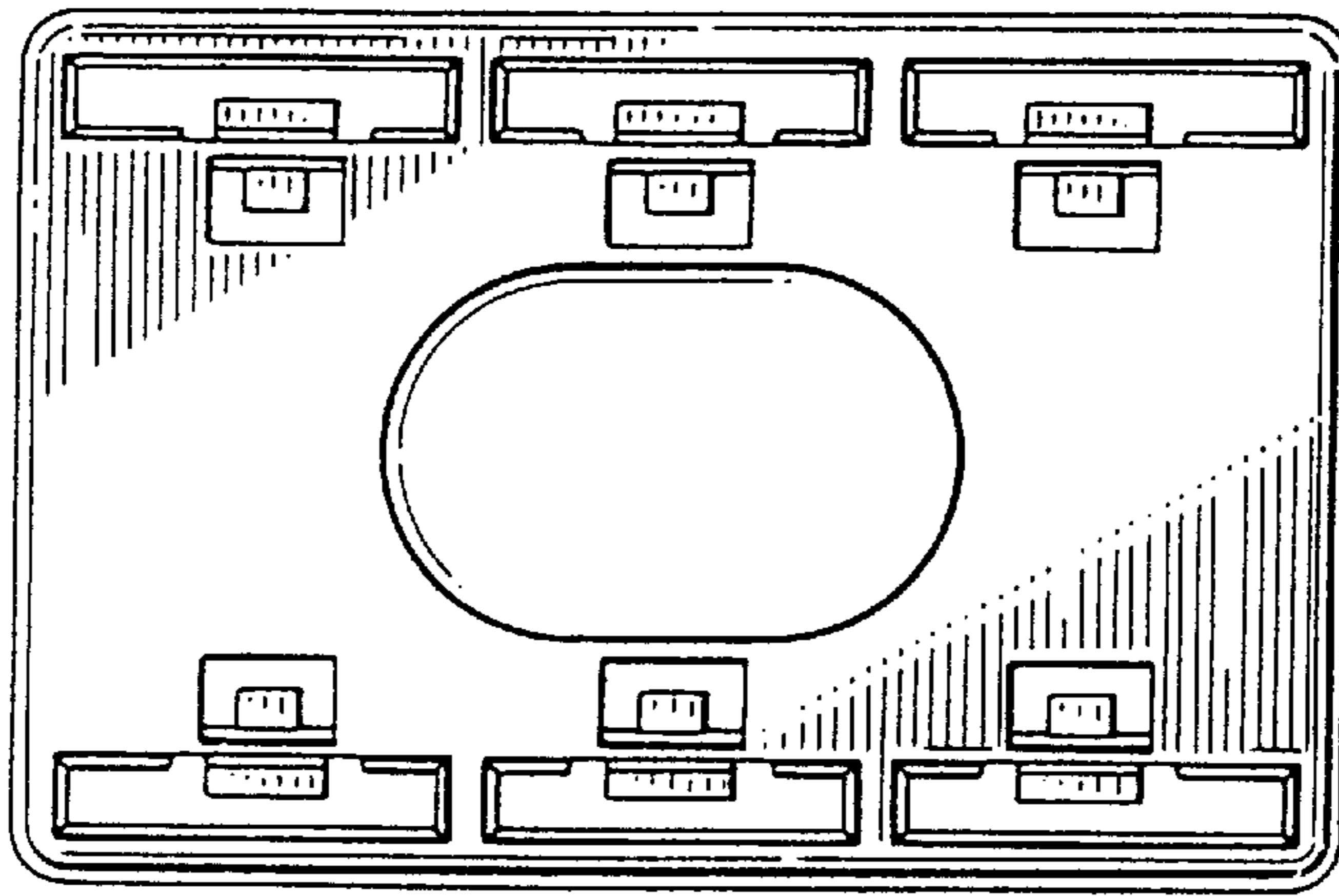

FIG. 37



FIG. 38

50 ↑



↑ 50

FIG. 39

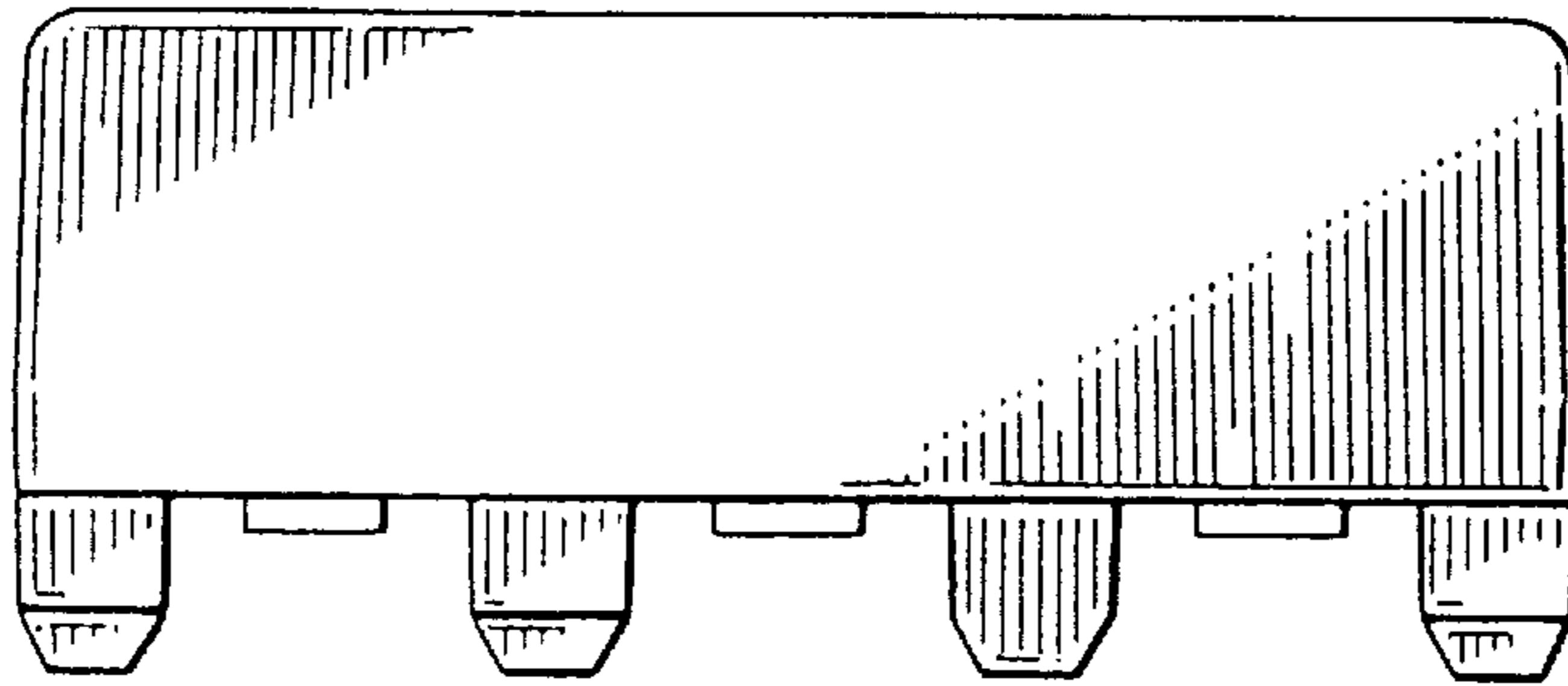
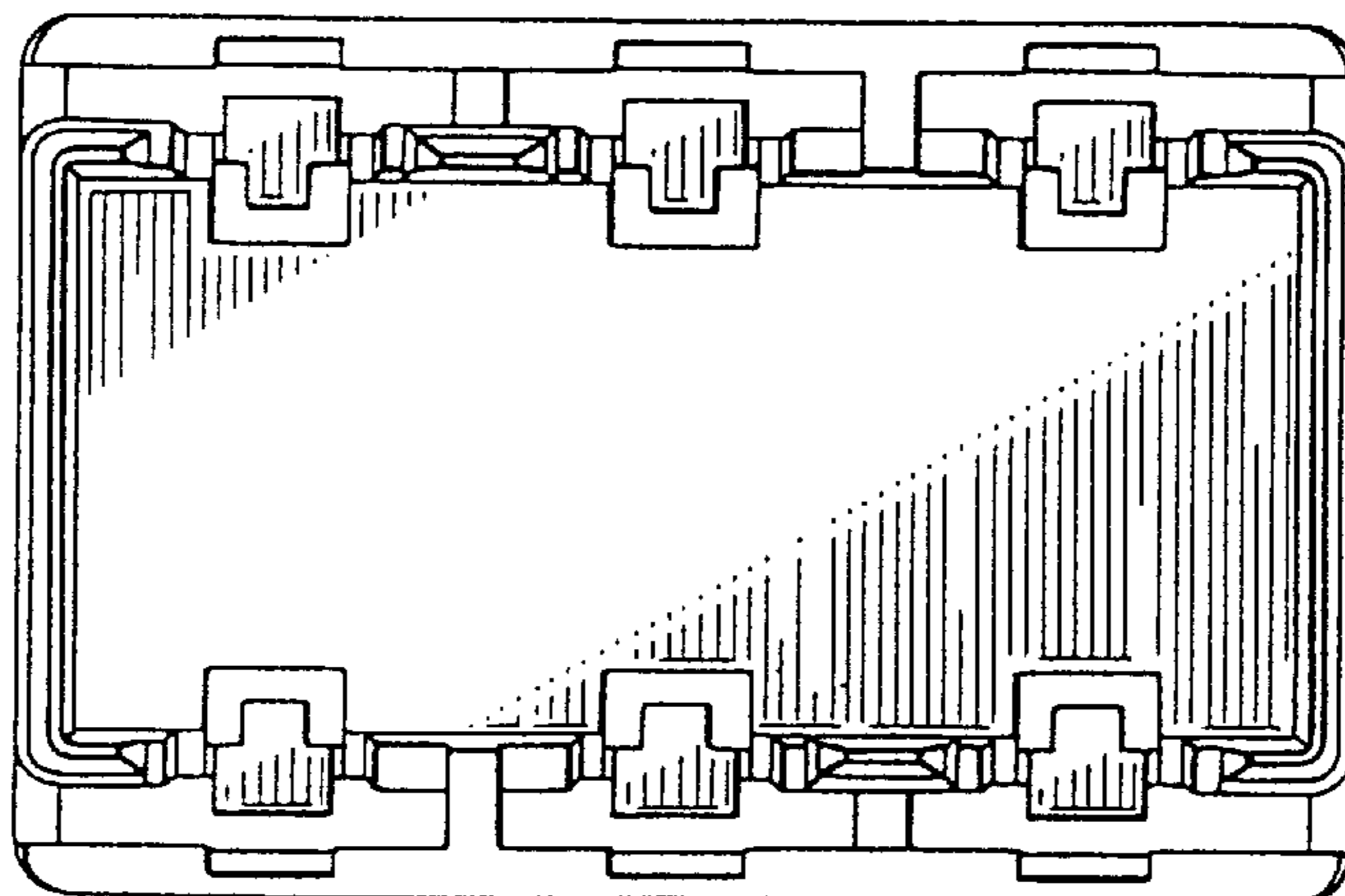

FIG. 40

48 ↓



↓ 48

49 ↓

↓ 49

FIG. 41

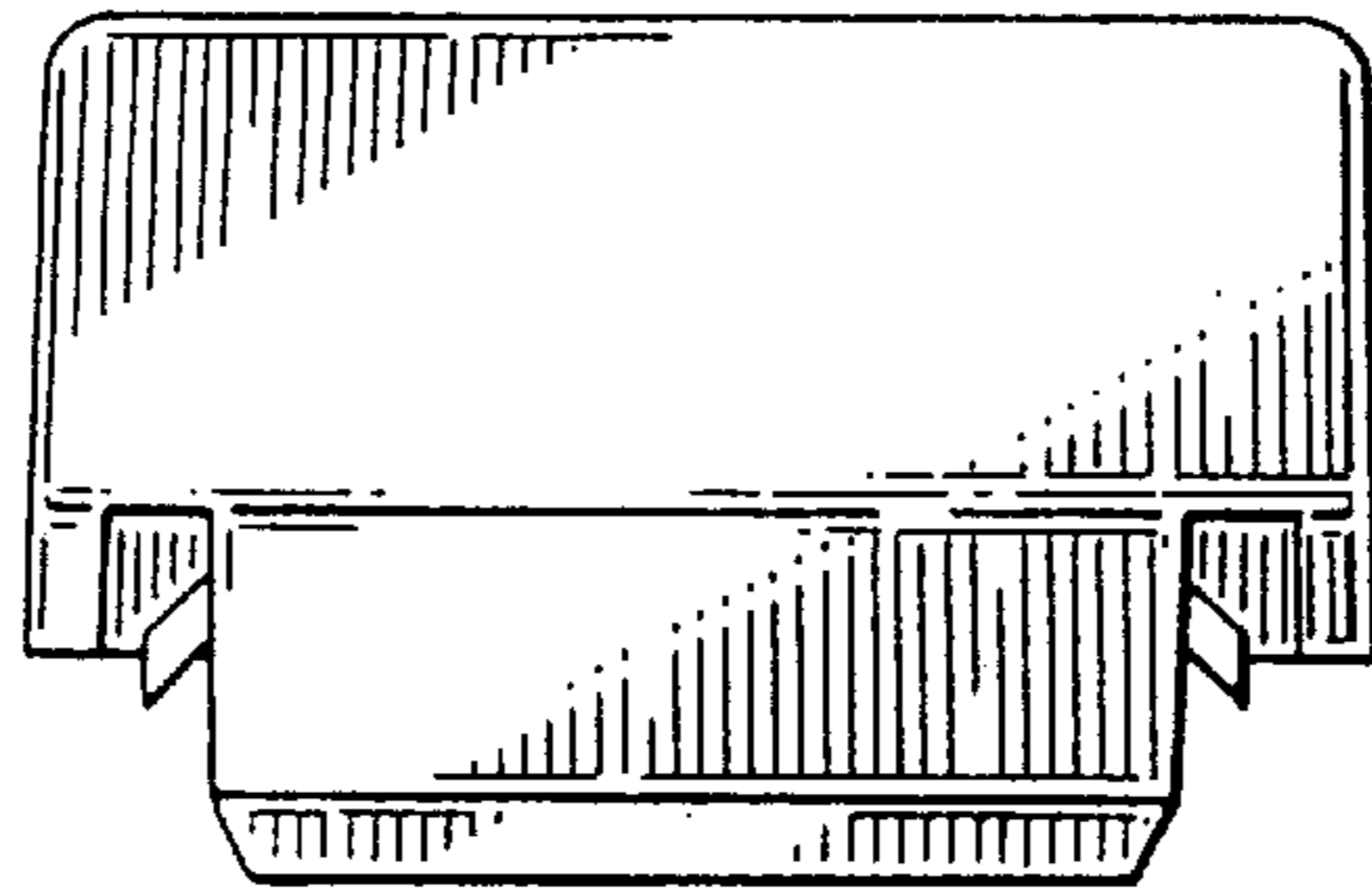

FIG. 42

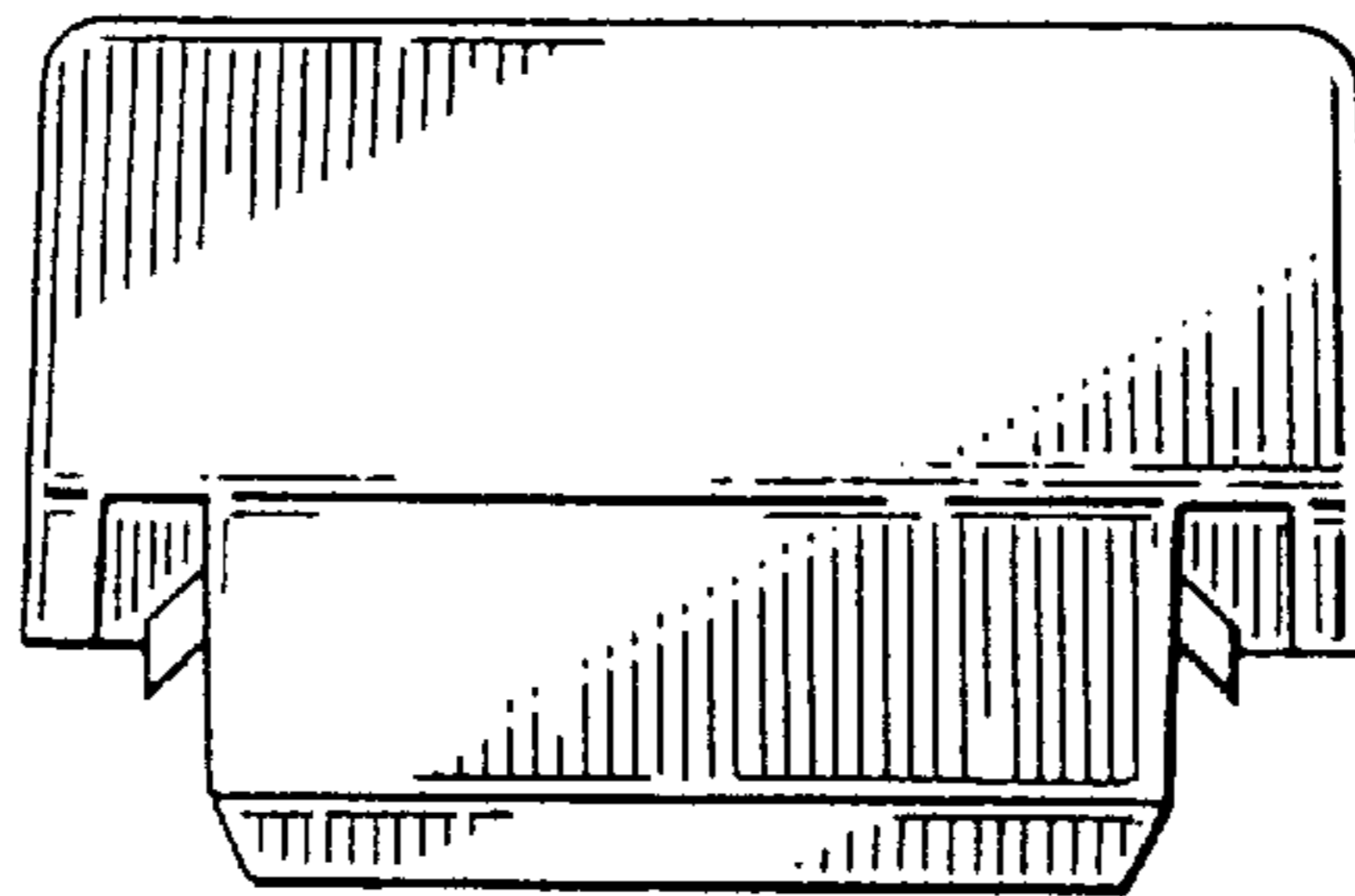

FIG. 43

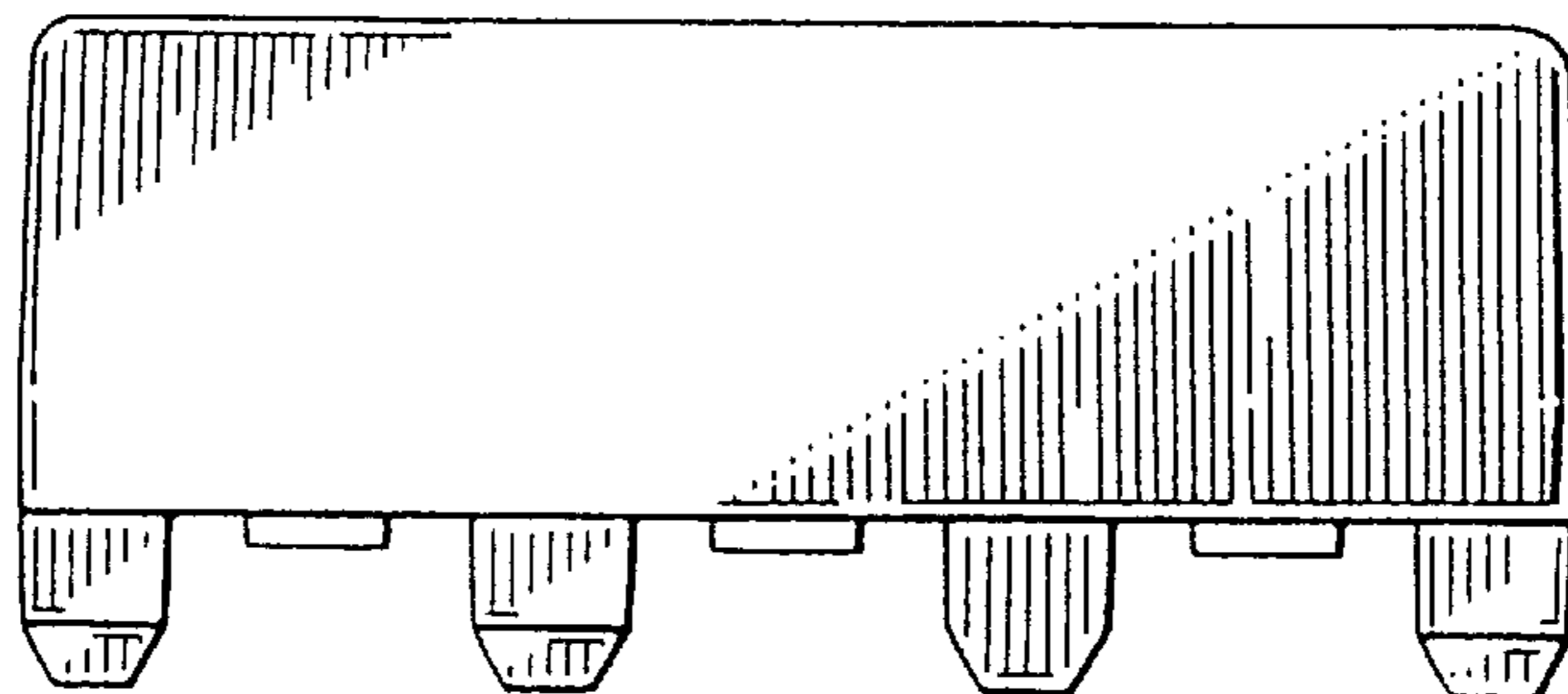

FIG. 44

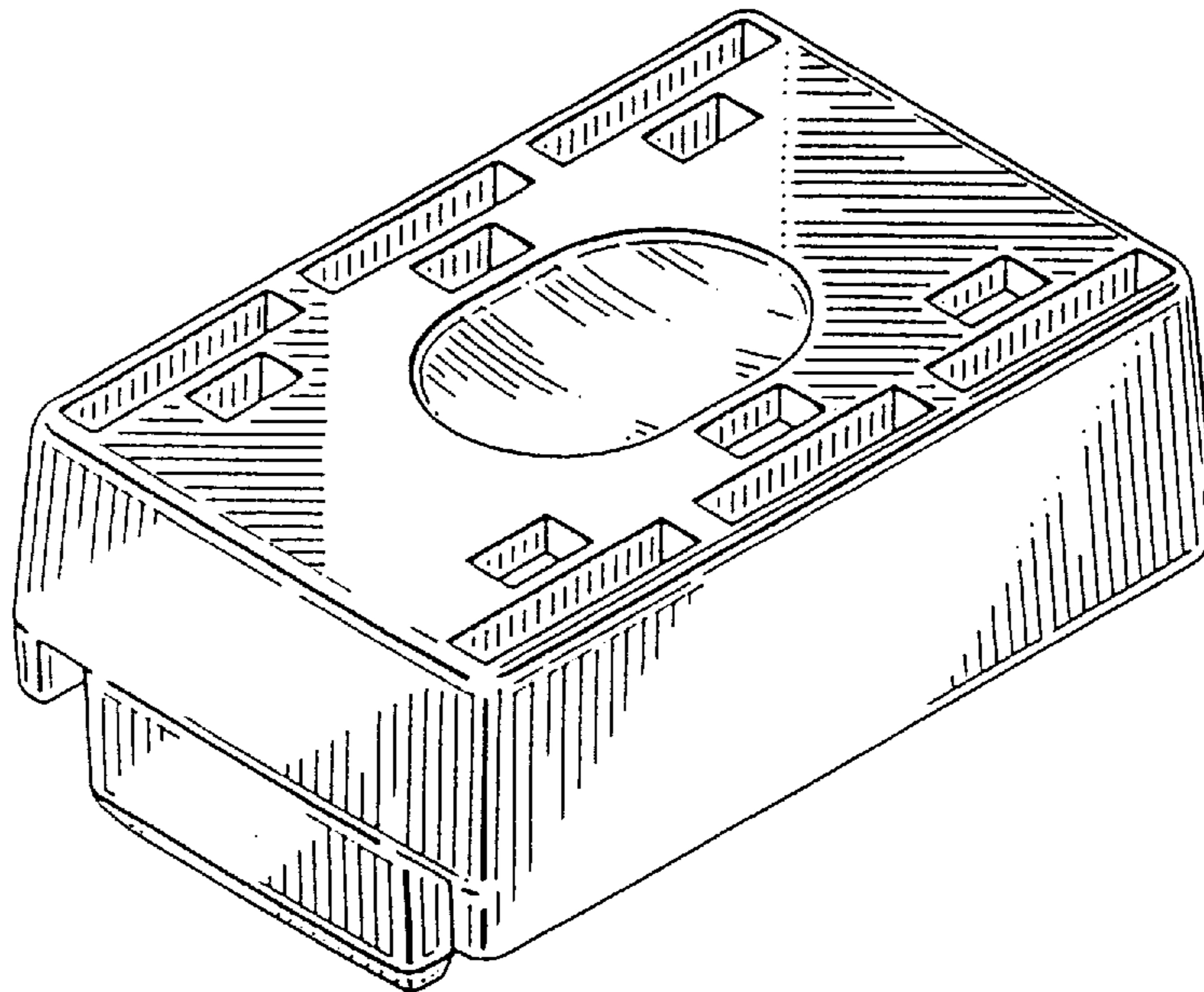

FIG. 45

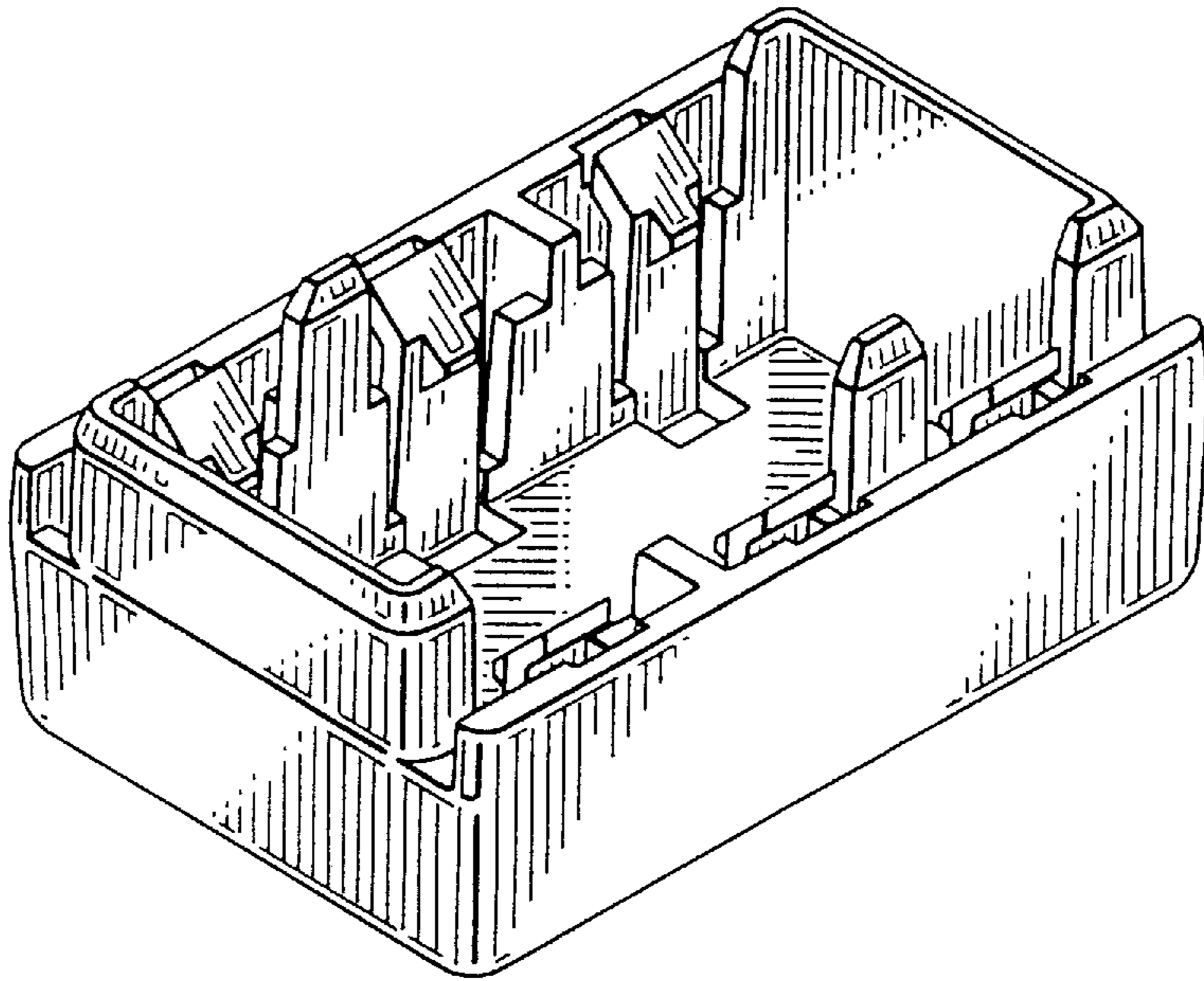

FIG. 47

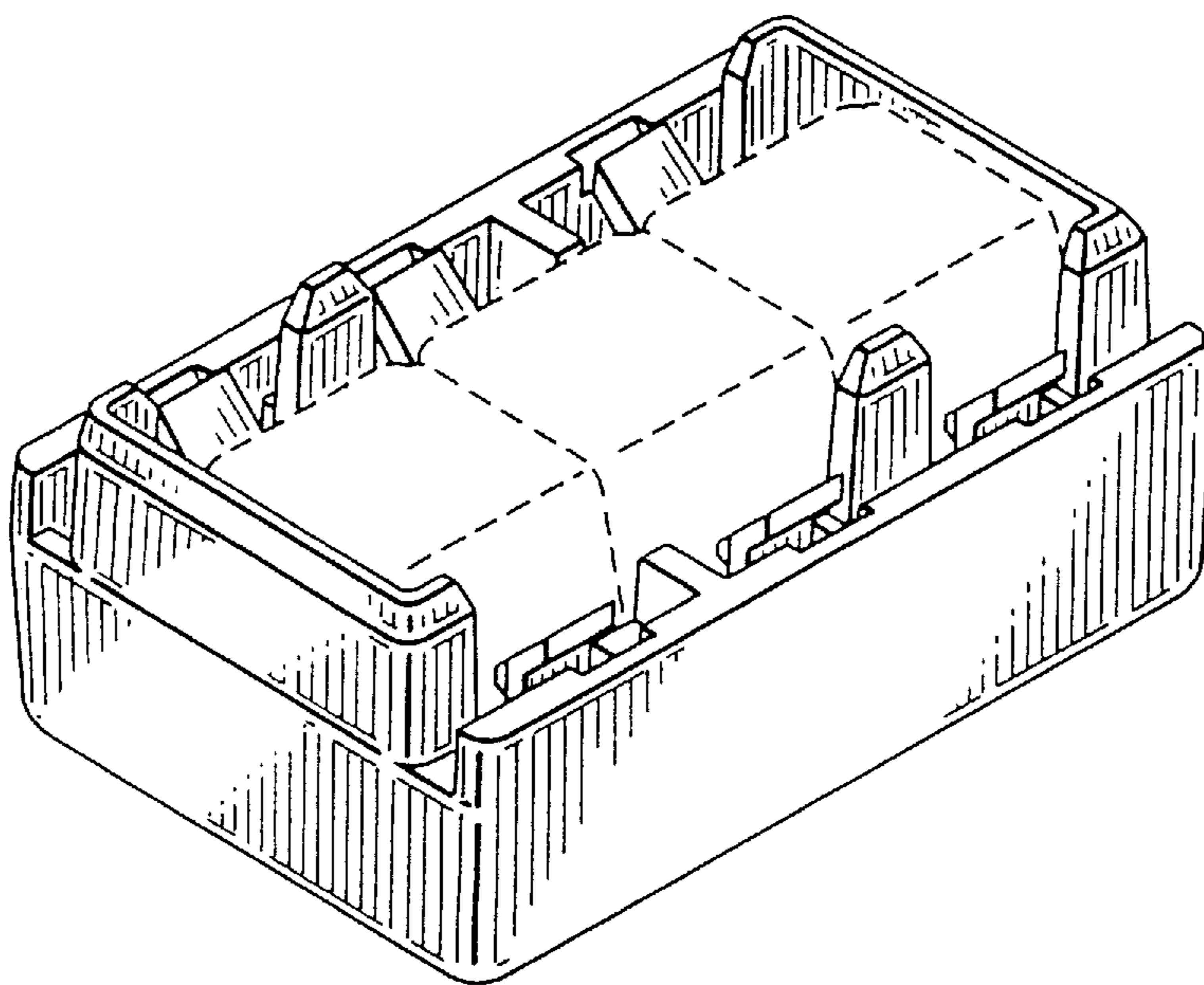

FIG. 46

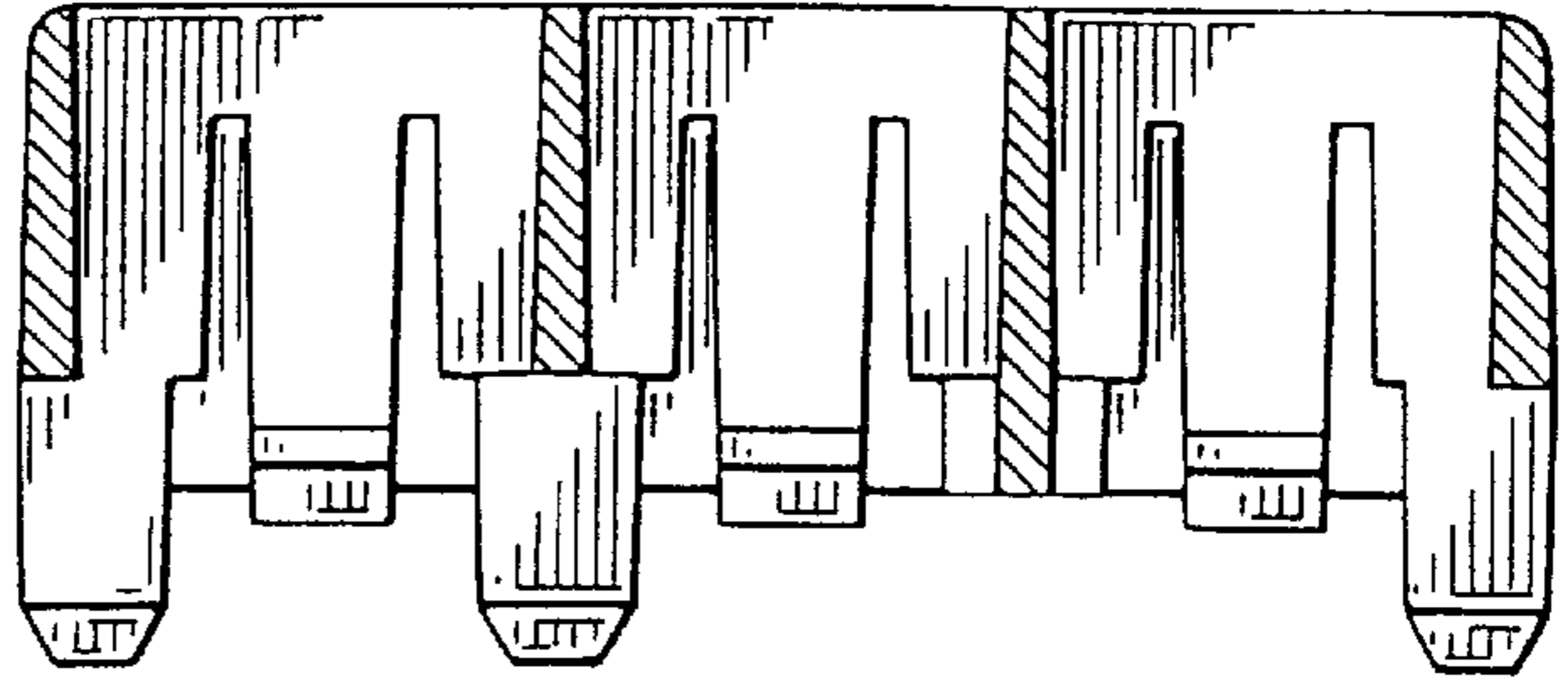

FIG. 48

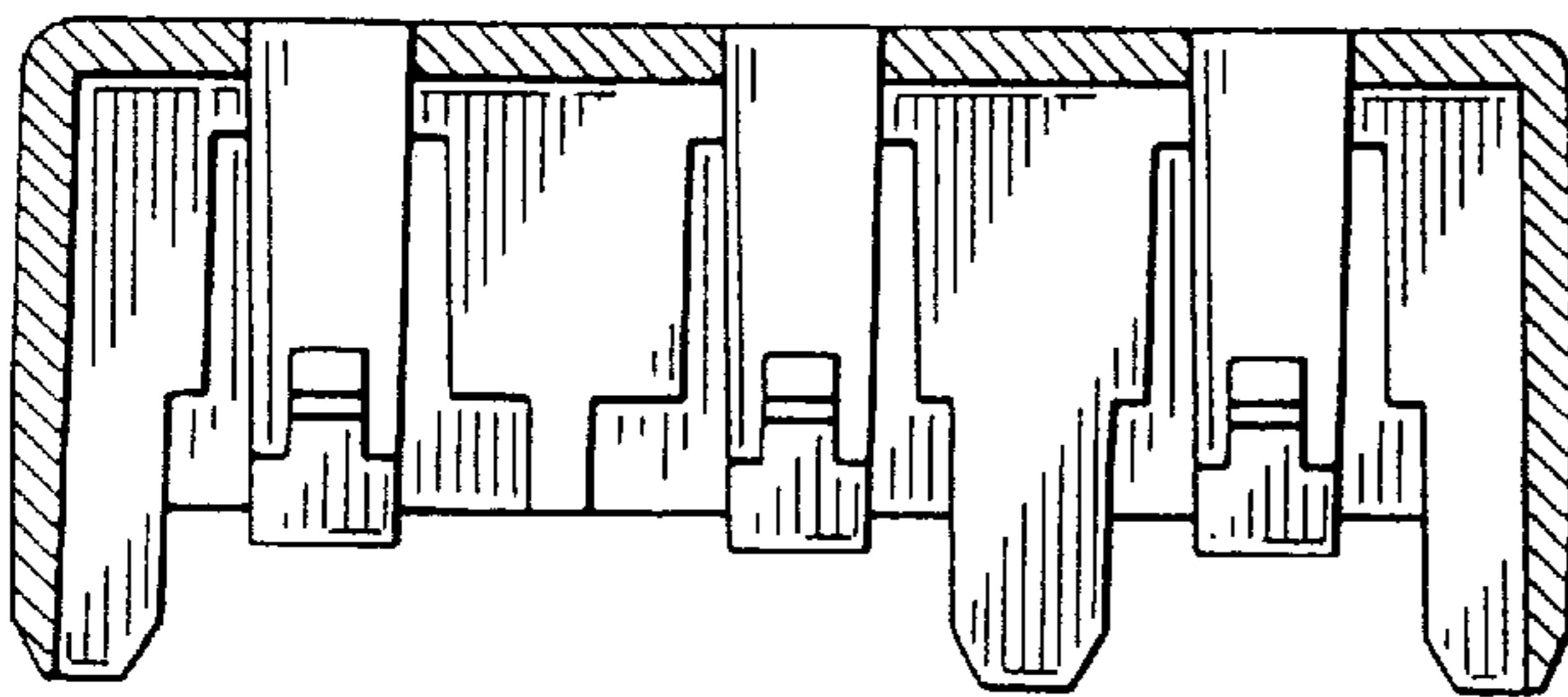

FIG. 49



FIG. 50