



US00D407616S

United States Patent [19]
Seber

[11] **Patent Number:** **Des. 407,616**
[45] **Date of Patent:** ****Apr. 6, 1999**

[54] **COMBINATION TOOL**

[76] **Inventor:** **Brett P. Seber**, 650 Sheridan Ave.,
Escondido, Calif. 92026

[**] **Term:** **14 Years**

[21] **Appl. No.:** **65,038**

[22] **Filed:** **Jan. 17, 1997**

[51] **LOC (6) Cl.** **08-05**

[52] **U.S. Cl.** **D8/55; D8/105**

[58] **Field of Search** D8/14, 51, 52,
D8/55, 105; 7/118, 129, 128, 132, 142,
163, 164, 168; 81/415, 427.5

[56] **References Cited**

U.S. PATENT DOCUMENTS

D. 149,934	6/1948	Cobb	D8/55
D. 286,501	11/1986	Magan .	
295,885	3/1884	Pullman .	
D. 338,386	8/1993	Frazer .	
D. 356,019	3/1995	Sakai .	
D. 368,634	4/1996	Frazer	D8/105
D. 382,182	8/1997	Seber et al. .	
988,068	3/1911	Beardsley et al. .	
1,194,296	8/1916	Jones et al. .	
1,370,906	3/1921	Newton .	
2,779,098	1/1957	Pocoski et al. .	
2,814,108	11/1957	Bassett .	
3,364,508	1/1968	Garrett .	
3,858,258	1/1975	Stevens	7/29
4,238,862	12/1980	Leatherman .	
4,744,272	5/1988	Leatherman	81/427.5
4,805,303	2/1989	Gibbs .	
4,888,869	12/1989	Leatherman .	
5,014,379	5/1991	Hull et al.	7/127

5,044,079	9/1991	Gibbs .	
5,062,173	11/1991	Collins et al. .	
5,142,721	9/1992	Sessions et al. .	
5,212,844	5/1993	Sessions et al. .	
5,245,721	9/1993	Lowe et al.	7/129
5,267,366	12/1993	Frazer	7/128
5,320,004	6/1994	Hsiao .	
5,491,856	2/1996	Legg .	

OTHER PUBLICATIONS

Hoffritz Holiday Catalog, see tool p. 24 (center), 1998.

Primary Examiner—Martie K. Holtje
Attorney, Agent, or Firm—Kelly Bauersfeld; Lowry & Kelley, LLP

[57] **CLAIM**

The ornamental design for a combination tool, as shown and described.

DESCRIPTION

FIG. 1 is a top view of a combination tool with the handles in the folded close position;
FIG. 2 is a bottom view thereof;
FIG. 3 is a left elevational view thereof;
FIG. 4 is a right elevational view thereof;
FIG. 5 is a front elevational view thereof;
FIG. 6 is a back elevational view thereof;
FIG. 7 is a top view of the combination tool with the handles in the folded open position;
FIG. 8 is bottom view thereof;
FIG. 9 is a left elevational view thereof;
FIG. 10 is a right elevational view thereof;
FIG. 11 is a front elevational view thereof;
FIG. 12 is a back elevational view thereof.

1 Claim, 3 Drawing Sheets

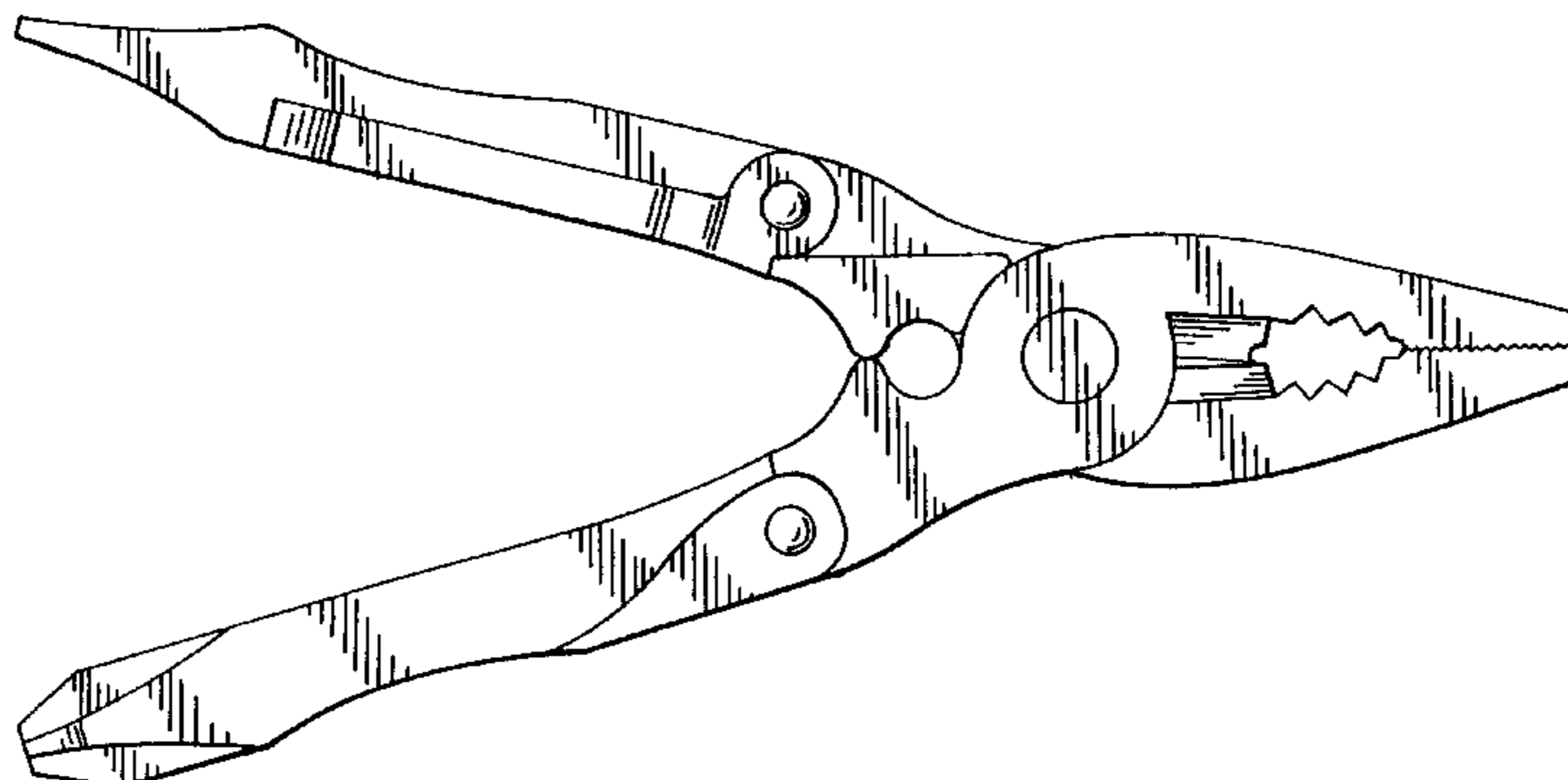
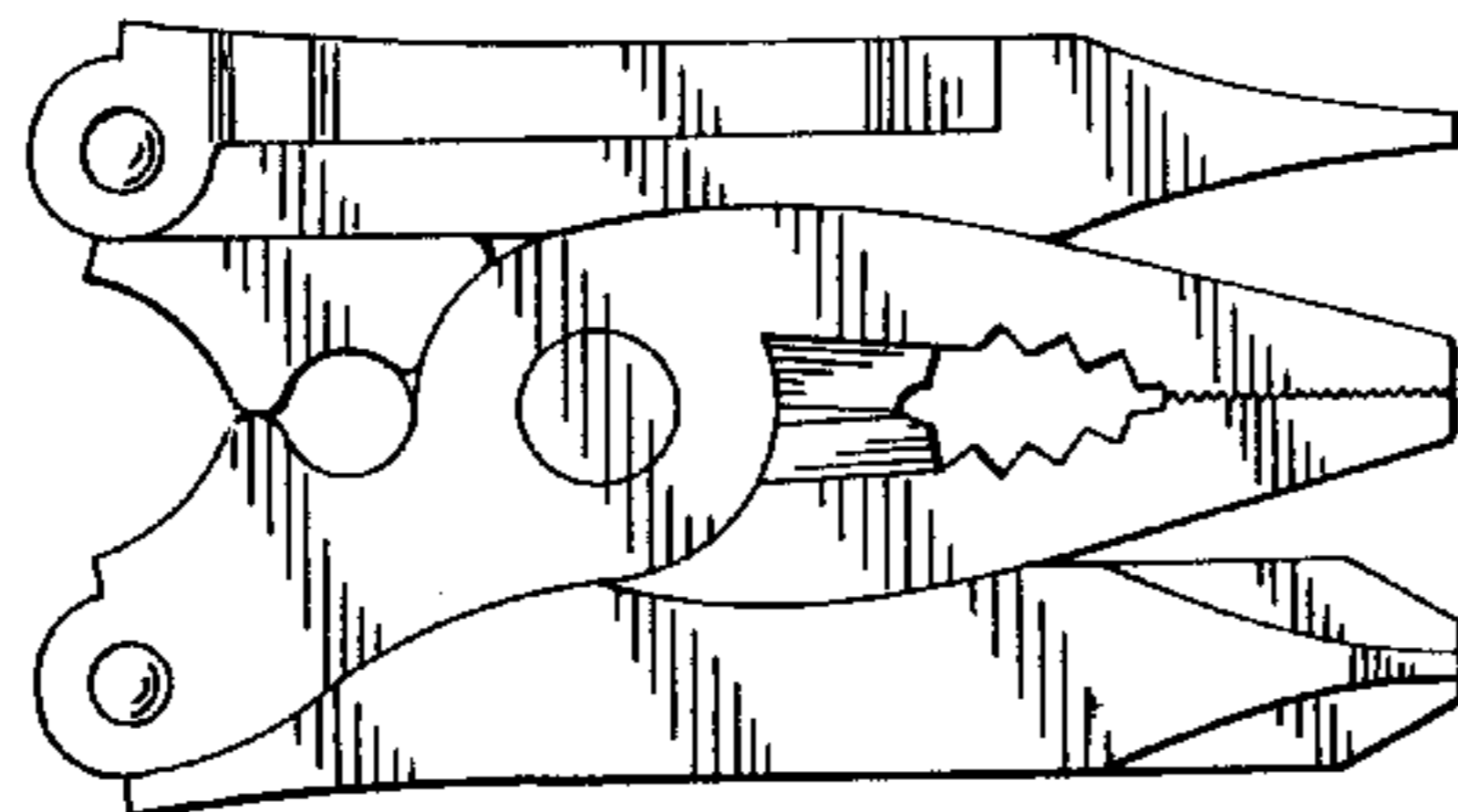

FIG. 1

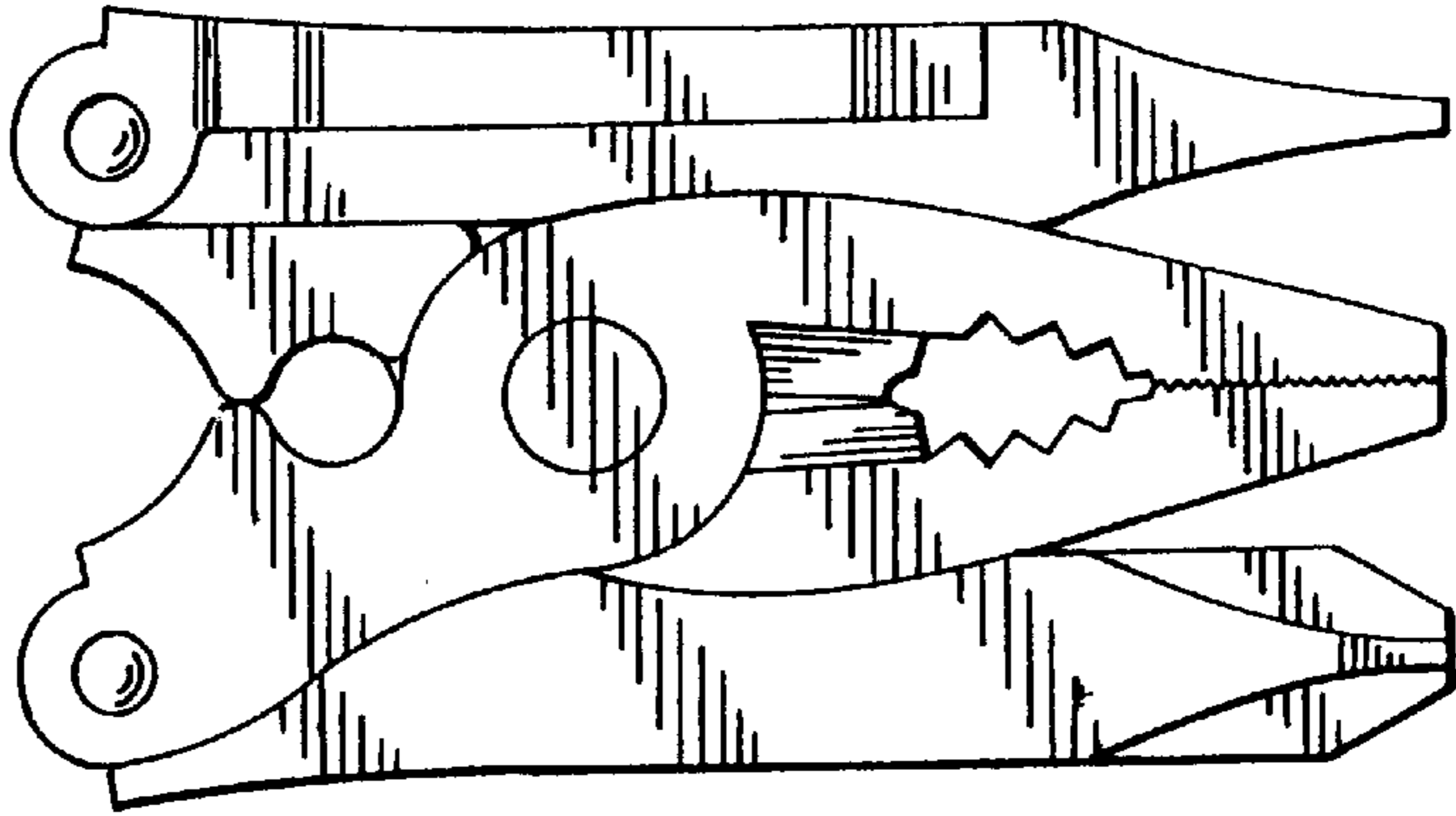

FIG. 2

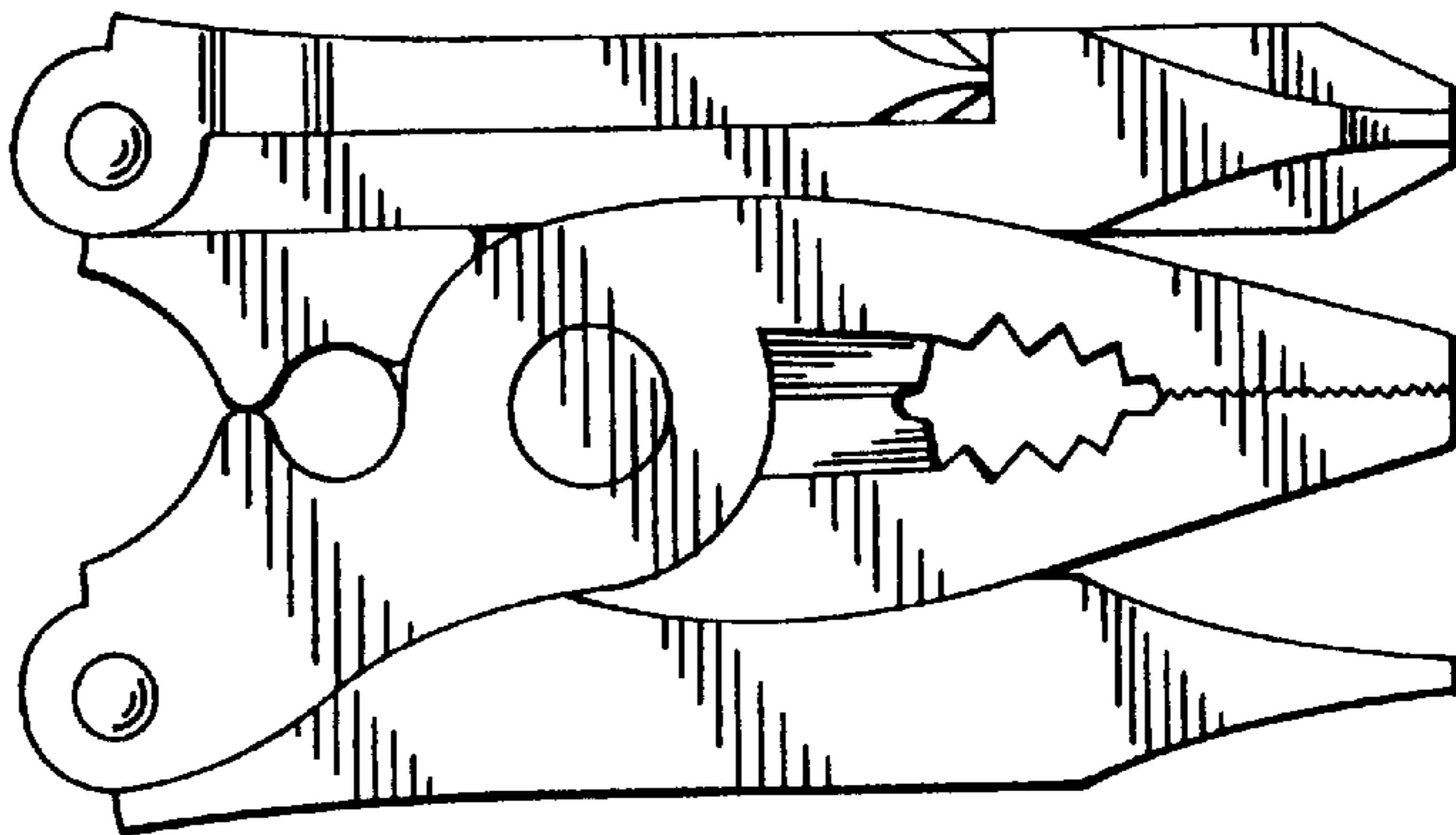

FIG. 3

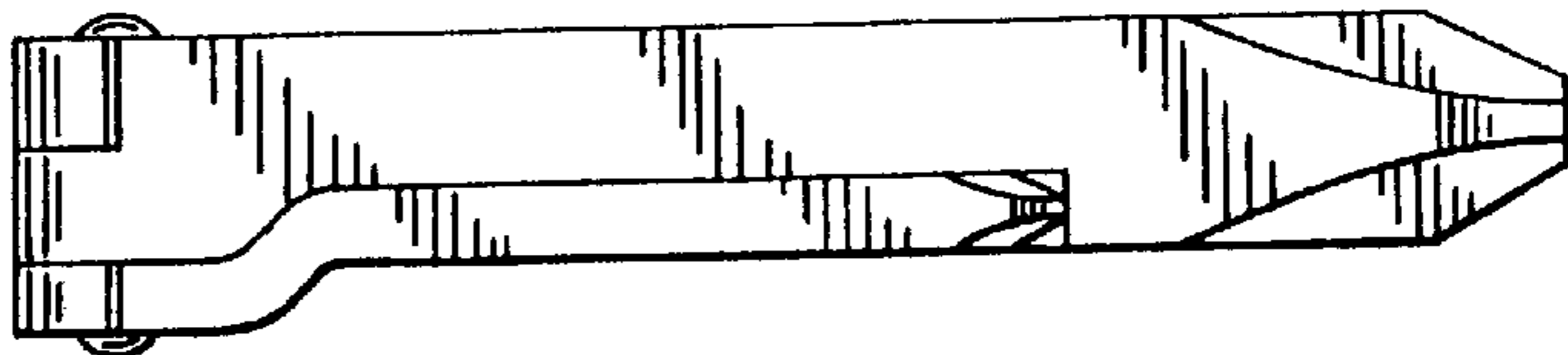

FIG. 4

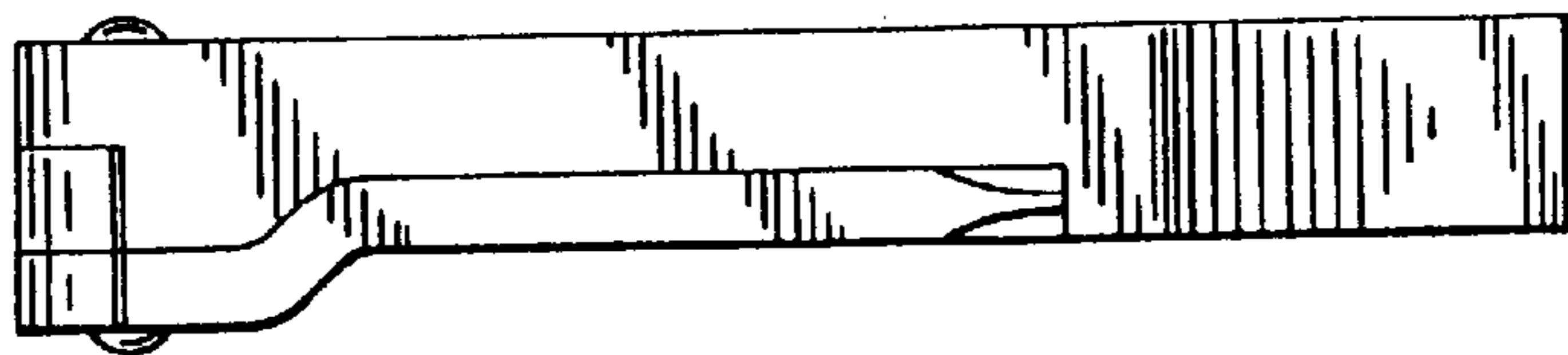

FIG. 5

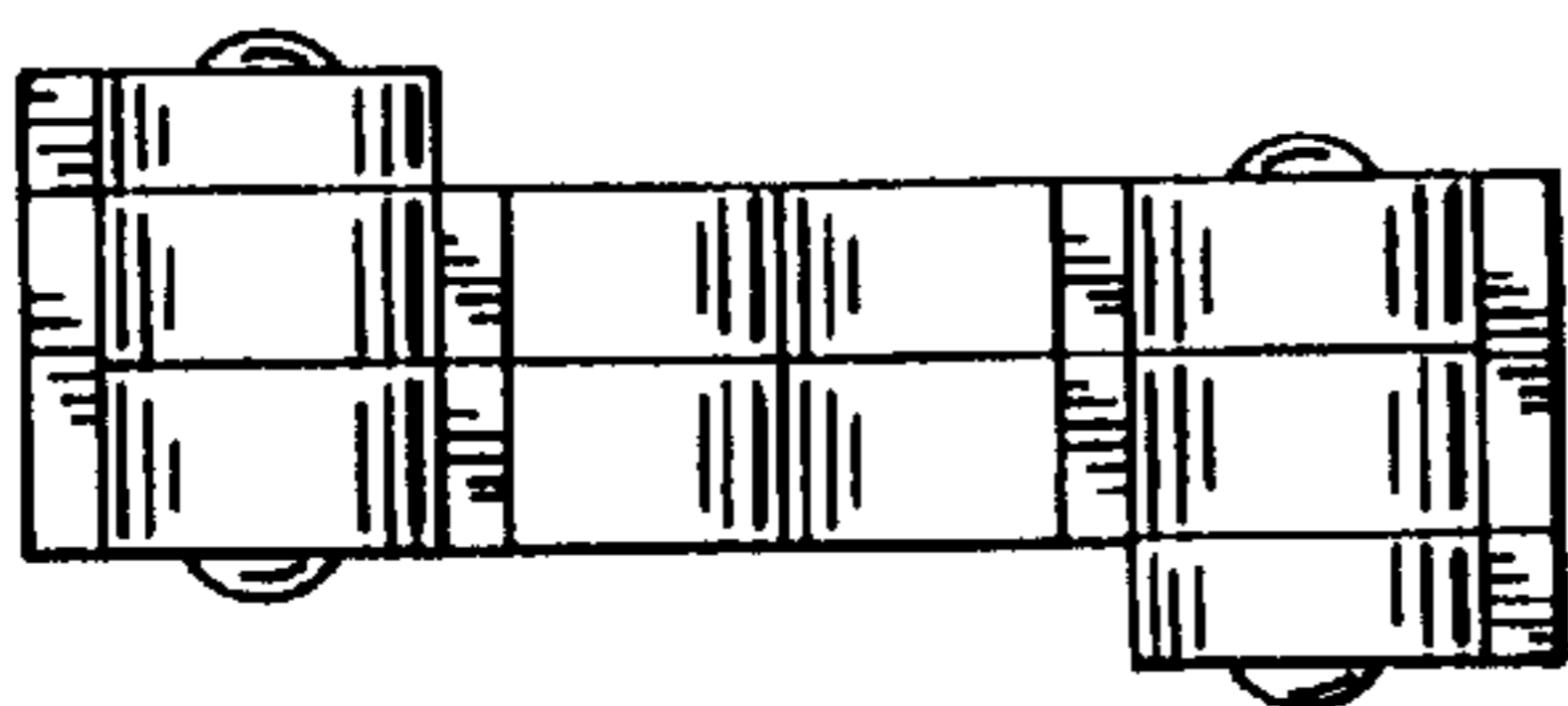
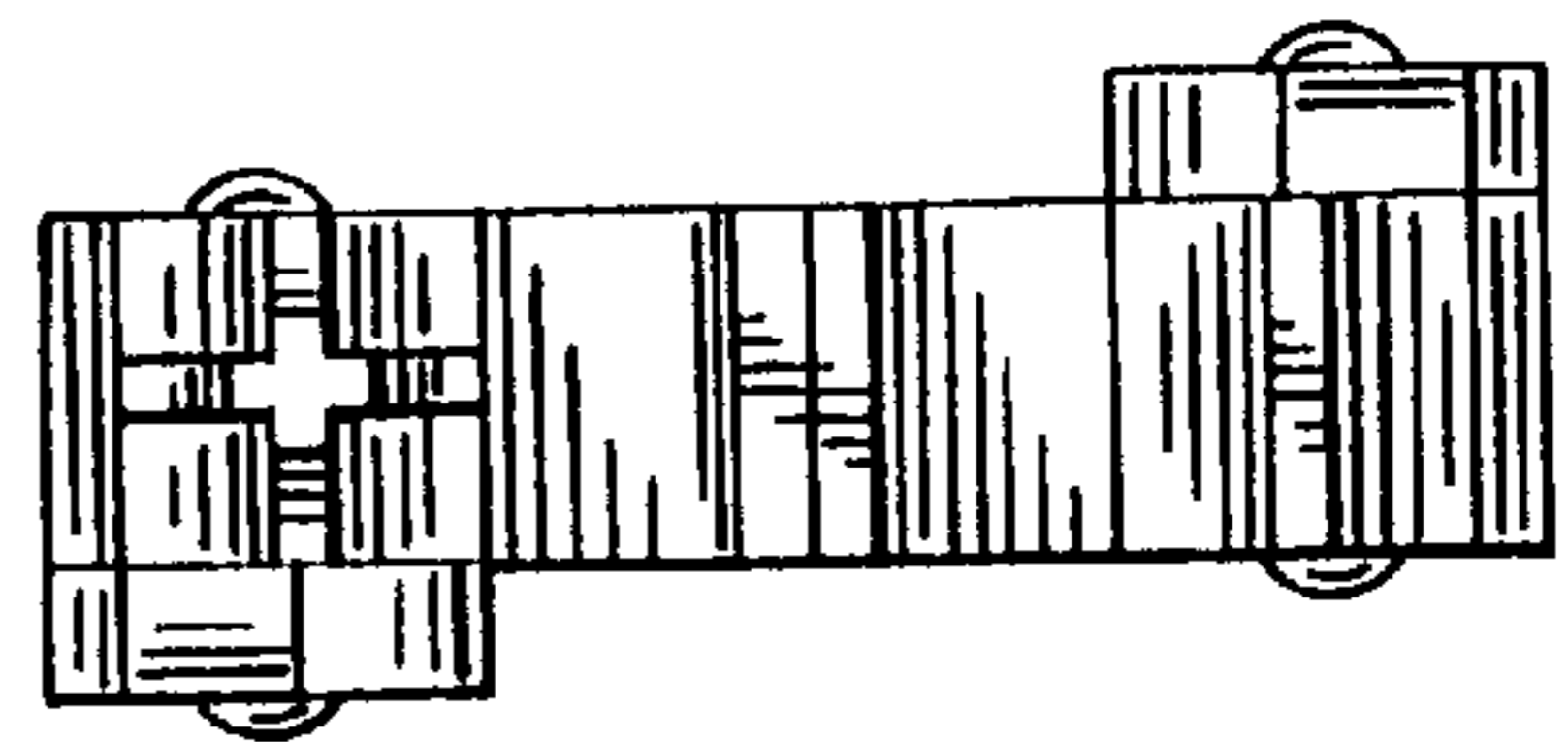

FIG. 6



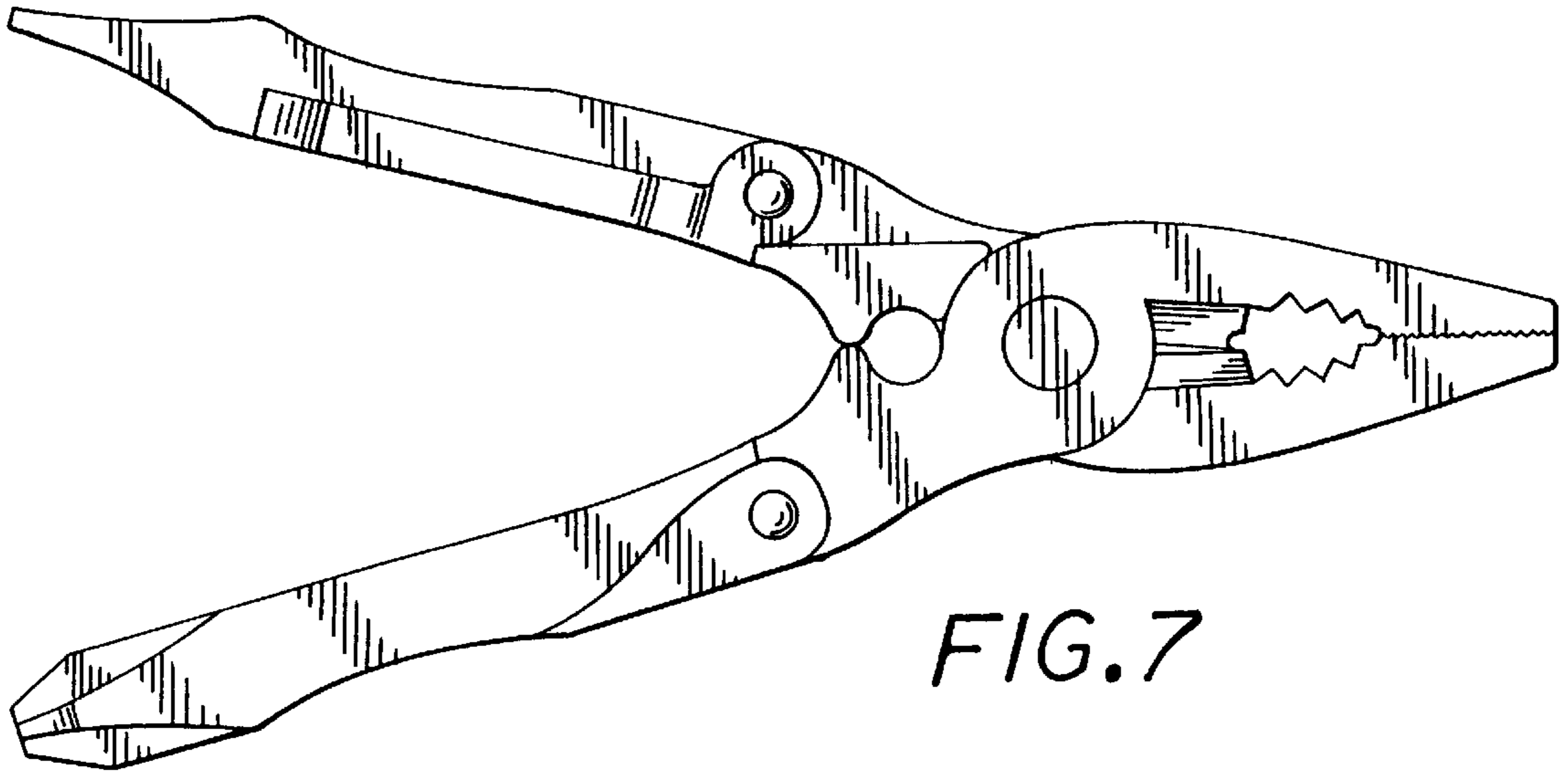

FIG. 7

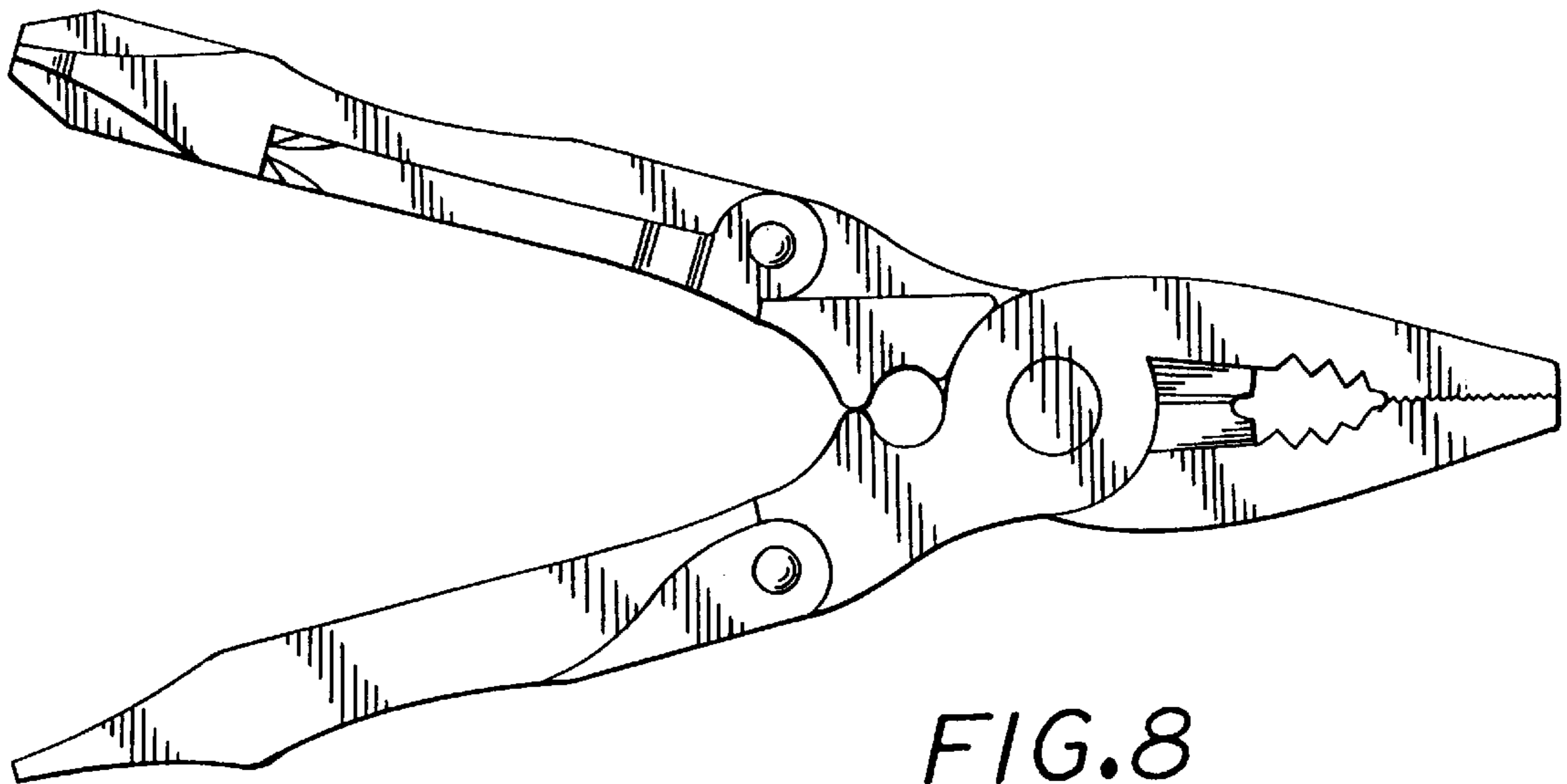

FIG. 8

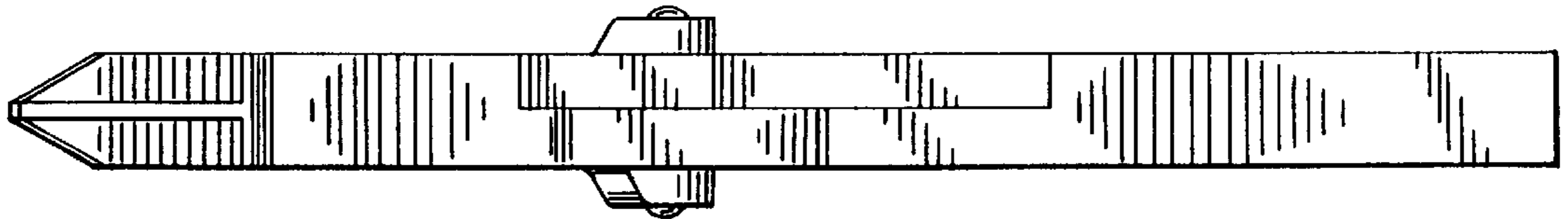

FIG. 9

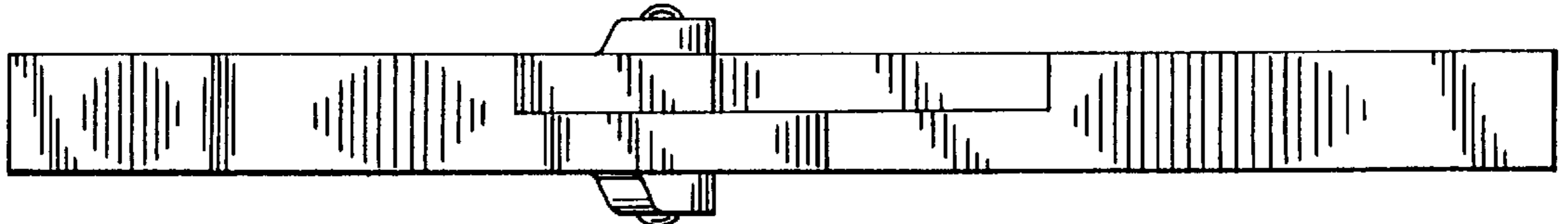

FIG. 10

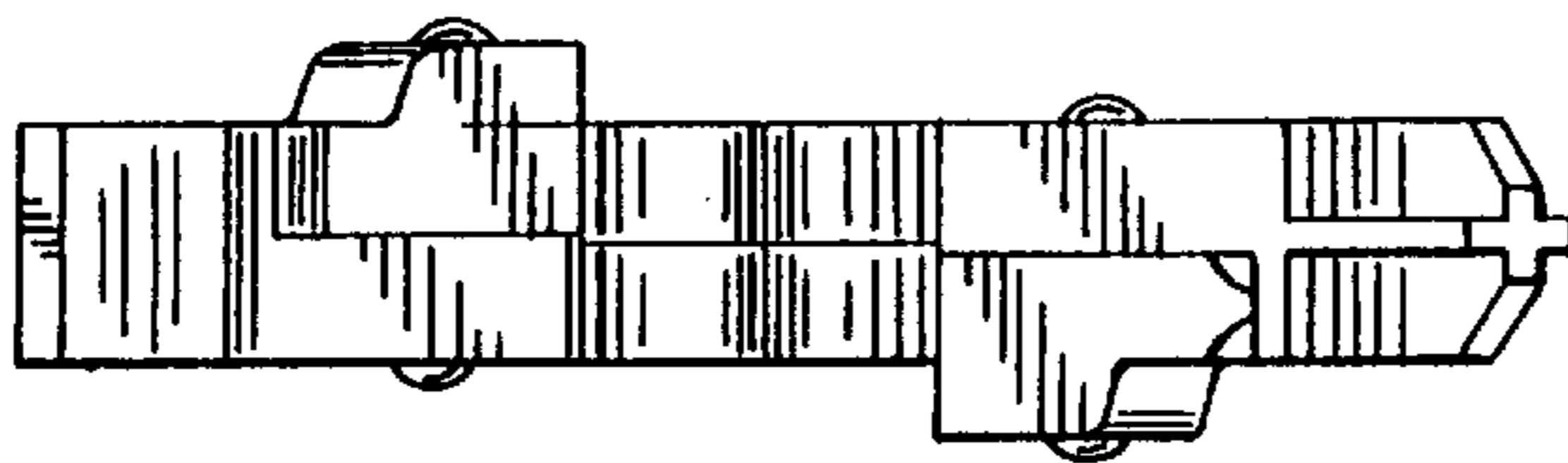

FIG. 11

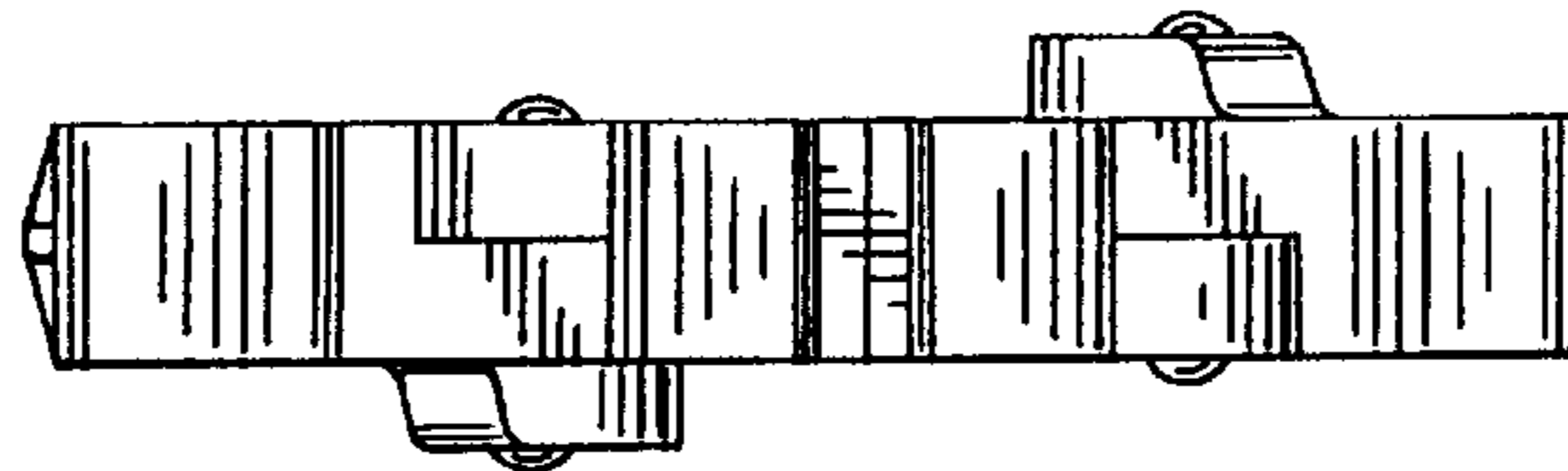

FIG. 12