



US00D407597S

**United States Patent** [19]  
**Diehl**

[11] **Patent Number: Des. 407,597**  
[45] **Date of Patent: \*\*Apr. 6, 1999**

[54] **JUICE CONTAINER**

[75] Inventor: **Jürgen Diehl**, Erbach, Germany

[73] Assignee: **Koziol Geschenkartikel GmbH**,  
Erbach, Germany

[\*\*] Term: **14 Years**

[21] Appl. No.: **78,775**

[22] Filed: **Oct. 31, 1997**

[30] **Foreign Application Priority Data**

Aug. 2, 1997 [DE] Germany ..... 97 07 209.5

[51] **LOC (6) Cl.** ..... **07-01**

[52] **U.S. Cl.** ..... **D7/317; D7/316; D7/510;**  
**D7/511**

[58] **Field of Search** ..... D7/536, 533, 510,  
D7/511, 523, 509, 513, 532, 512, 534,  
619, 622, 535, 531, 514, 317, 318, 319,  
590, 598, 312, 300, 316; 220/552, 555,  
713, 711, 771, 669, 755, 671, 672, 675,  
705, 708, 709, 756; 99/279, 295; 222/465.1,  
475.1, 494

[56] **References Cited**

**U.S. PATENT DOCUMENTS**

D. 209,073 10/1967 Martin ..... D7/317

D. 247,547 3/1978 Tuzes ..... D7/317  
D. 334,685 4/1993 Coulter ..... D7/317  
D. 365,247 12/1995 Sokolski et al. .... D7/511  
D. 379,732 6/1997 Jeppesen et al. .... D7/319  
D. 384,237 9/1997 Hess ..... D7/319  
3,858,767 1/1975 Borin ..... 222/494  
4,492,323 1/1985 Essen ..... 222/465.1  
4,802,406 2/1989 Bouldin ..... 99/295

*Primary Examiner*—M. N. Pandozzi  
*Attorney, Agent, or Firm*—Michael J. Striker

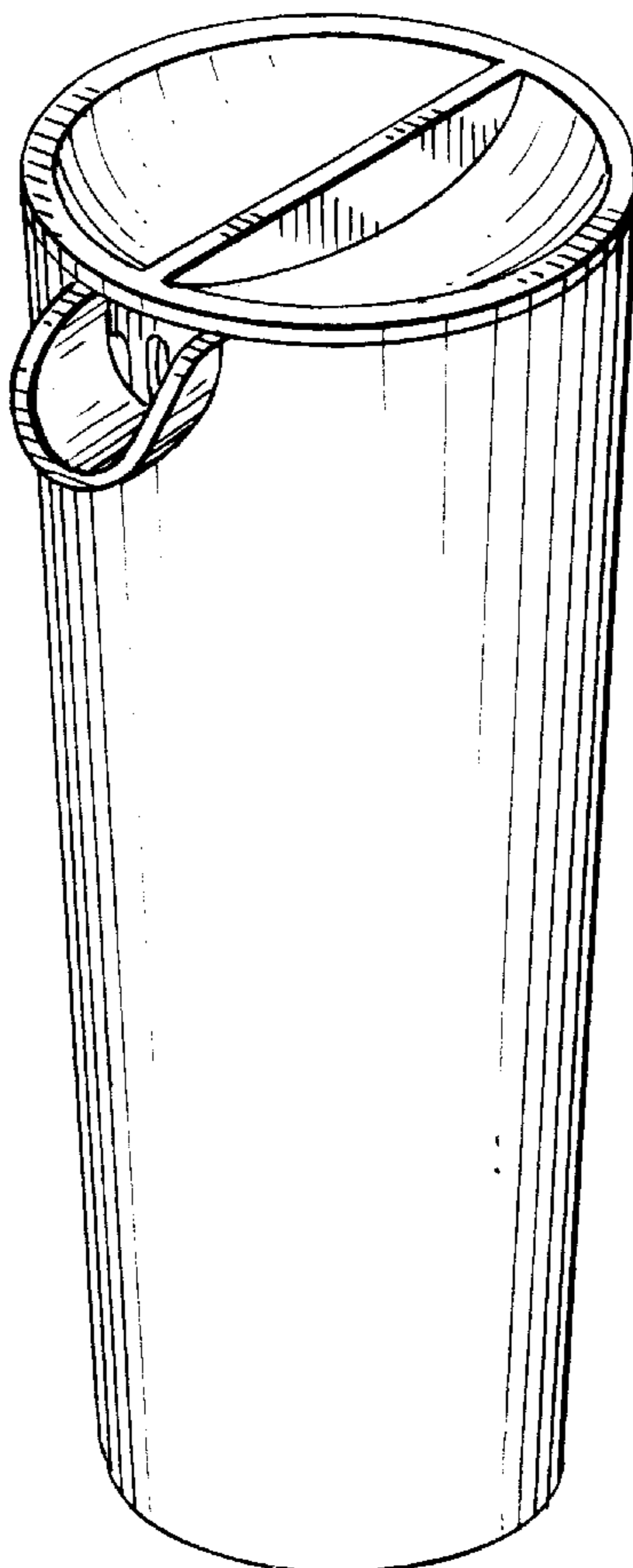
[57] **CLAIM**

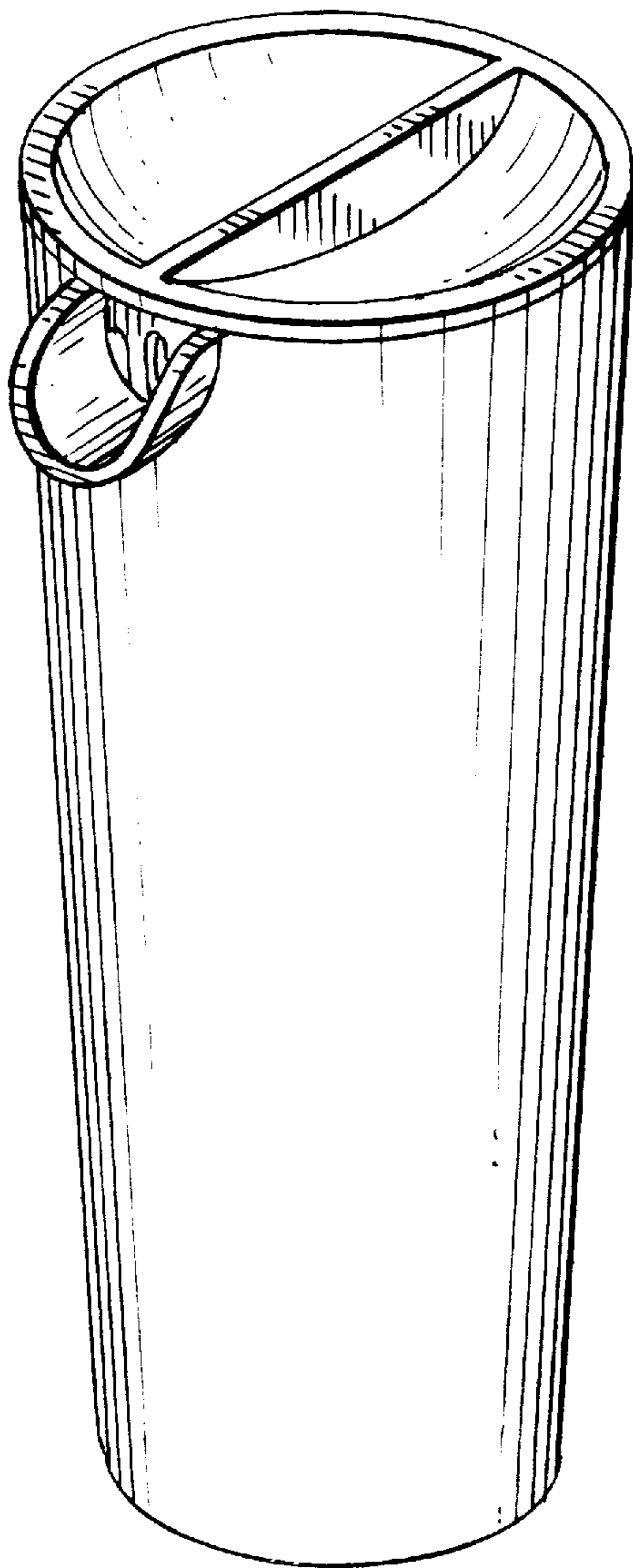
The ornamental design for a juice container, as shown and described.

**DESCRIPTION**

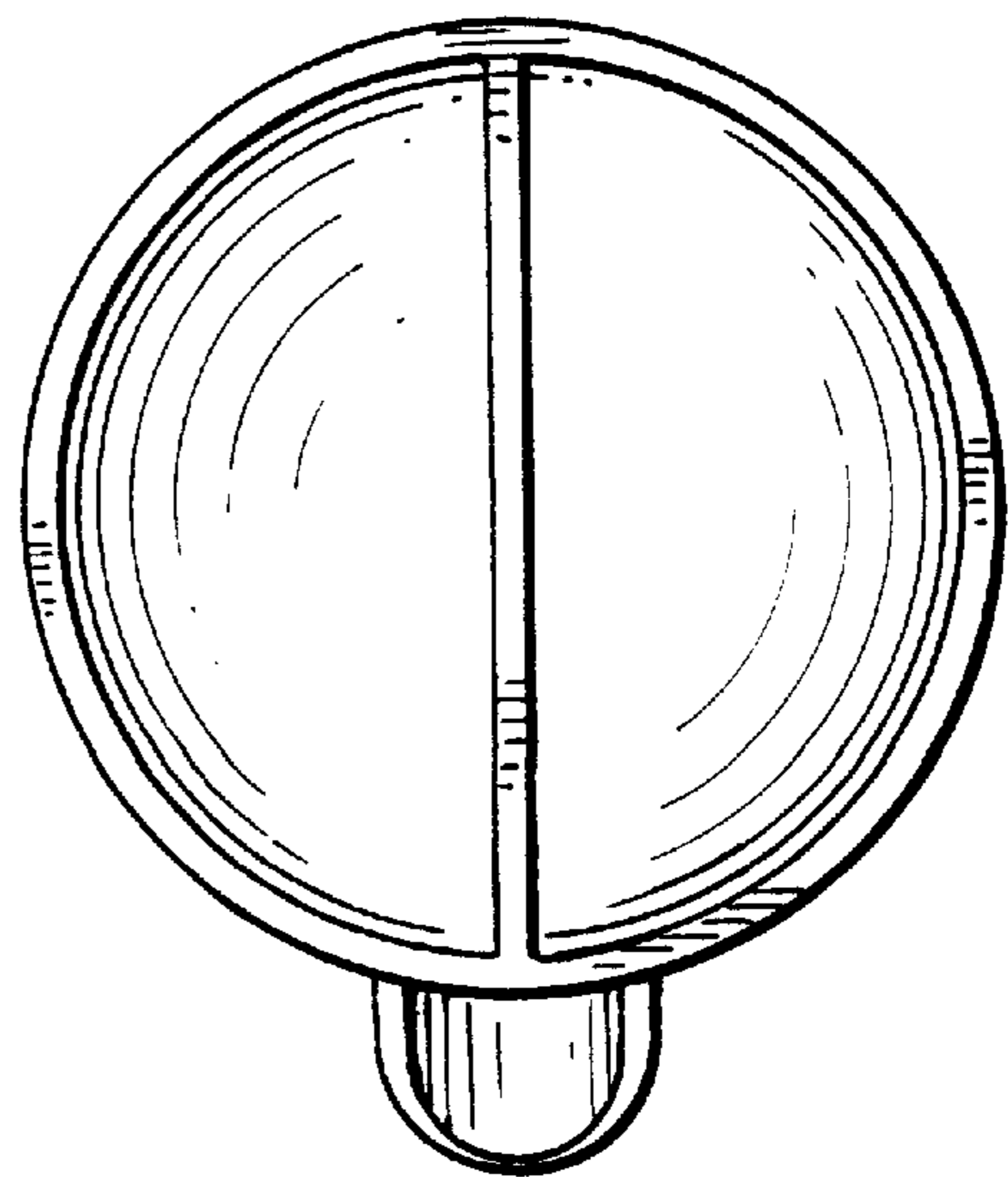
FIG. 1 is a top perspective view of a juice container showing my new design;  
FIG. 2 is a front elevational view thereof;  
FIG. 3 is a rear elevational view thereof;  
FIG. 4 is a top plan view;  
FIG. 5 is a bottom plan view;  
FIG. 6 is a left side elevational view thereof; and,  
FIG. 7 is a right side elevational view thereof.  
Any undisclosed surface area in any figure is without ornamentation.

**1 Claim, 3 Drawing Sheets**



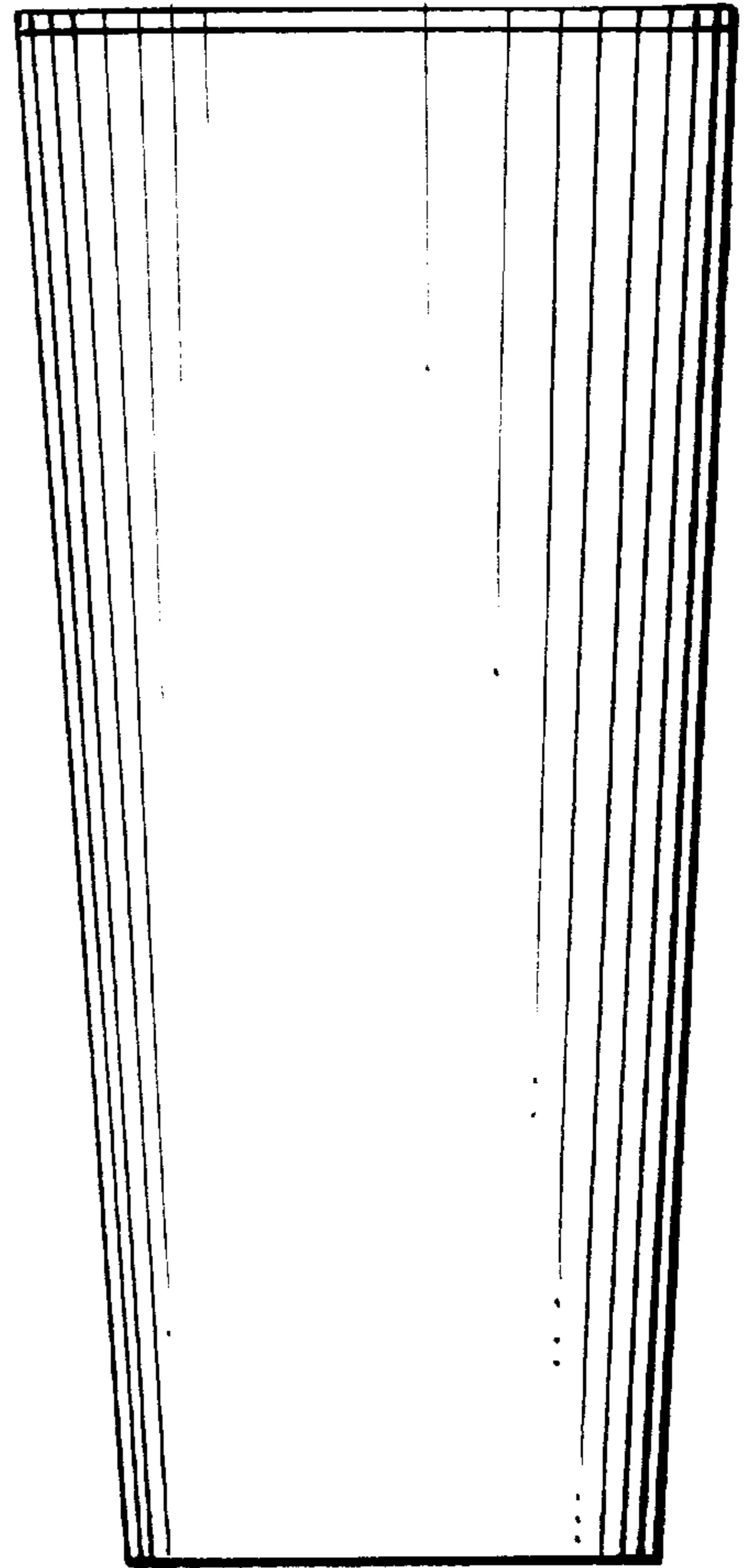
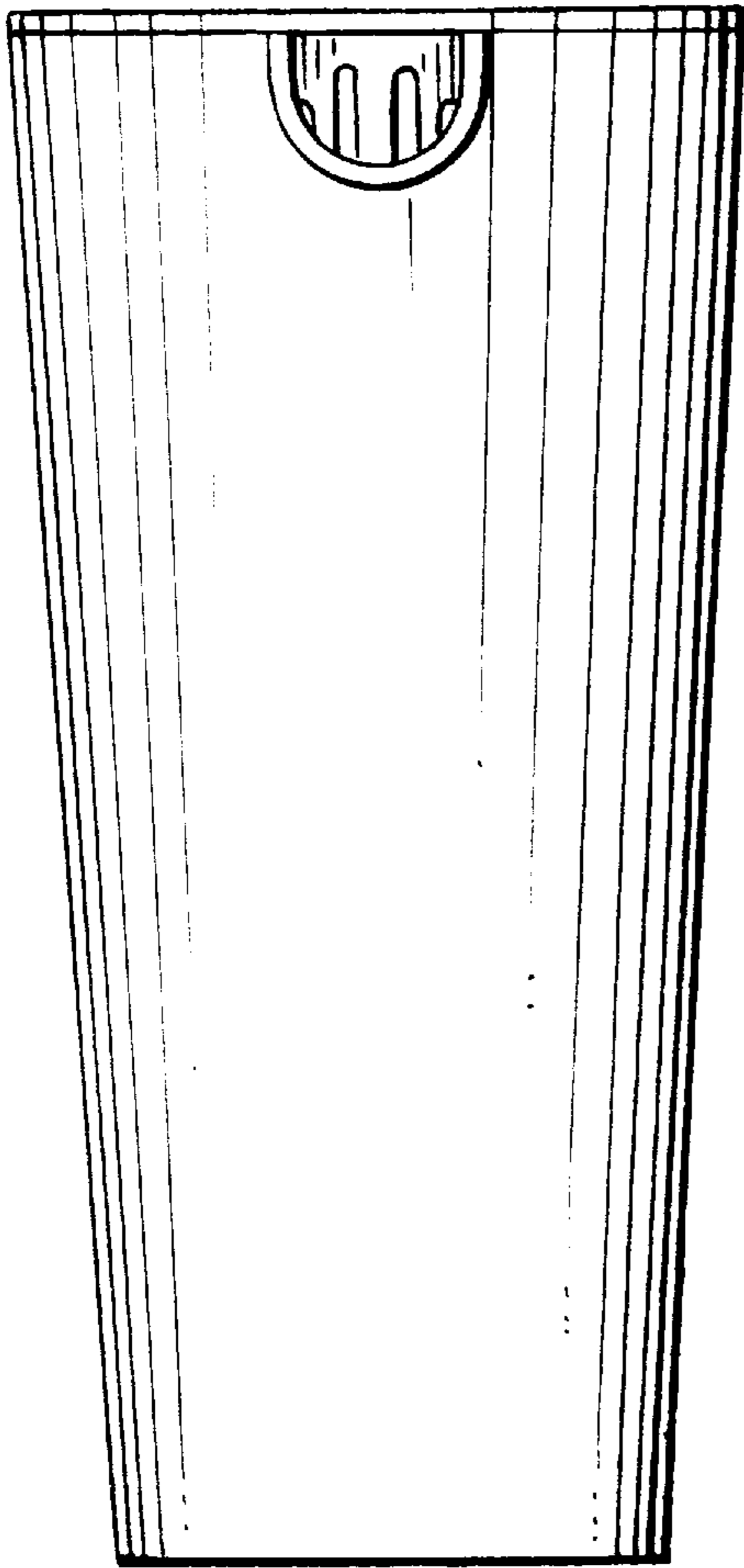


*FIG. 1*



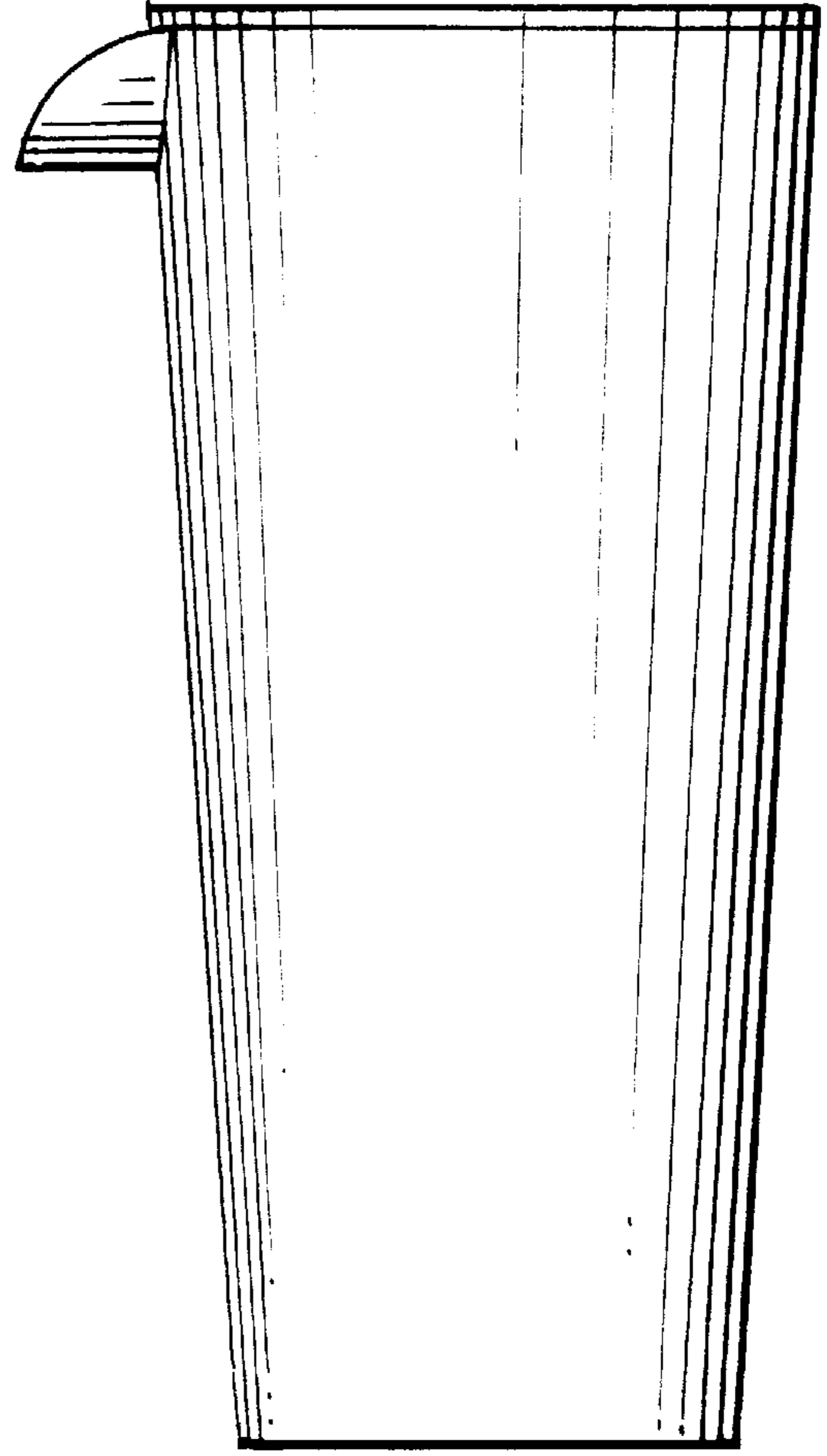
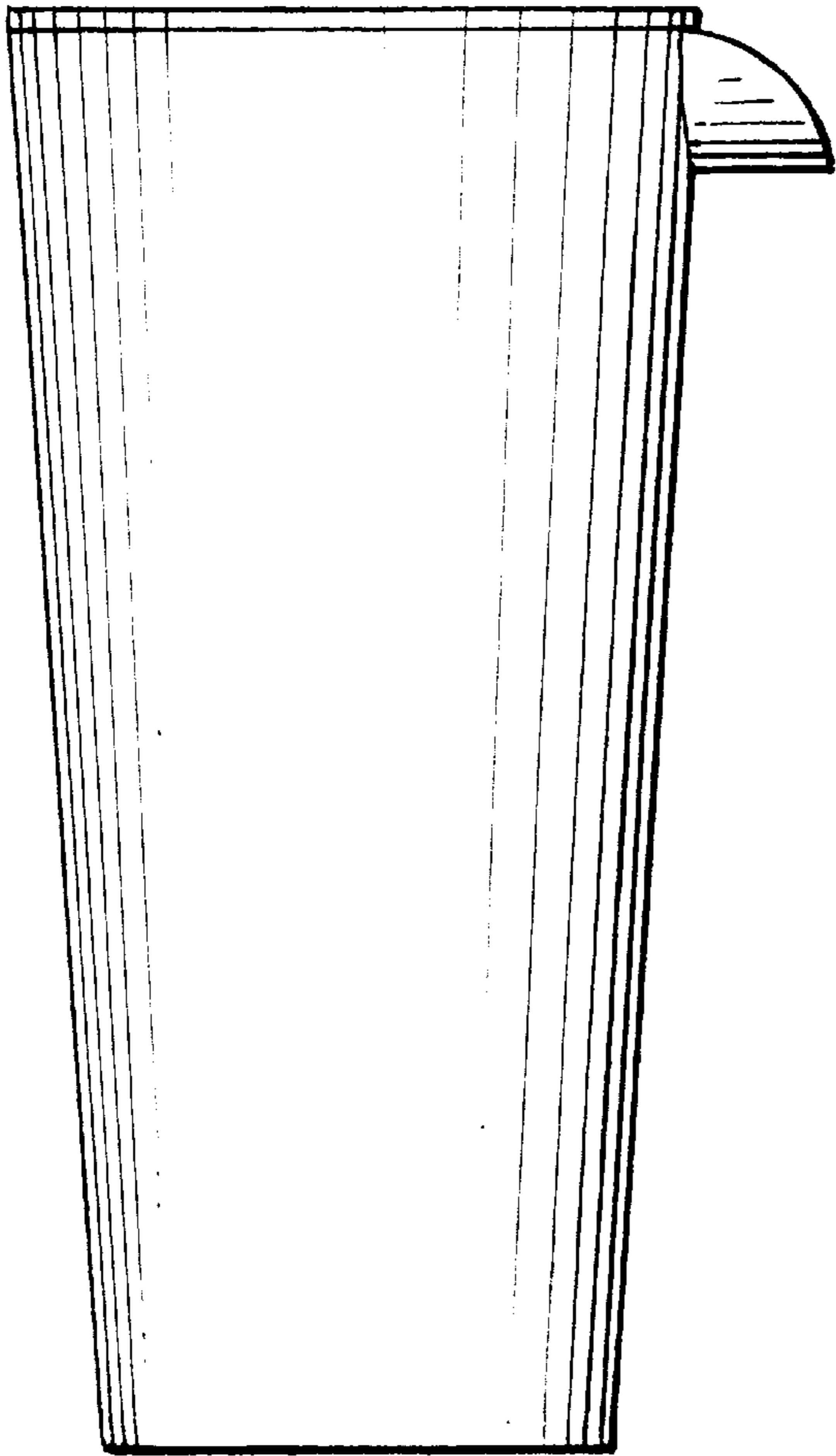
*FIG. 4*

*FIG. 2*

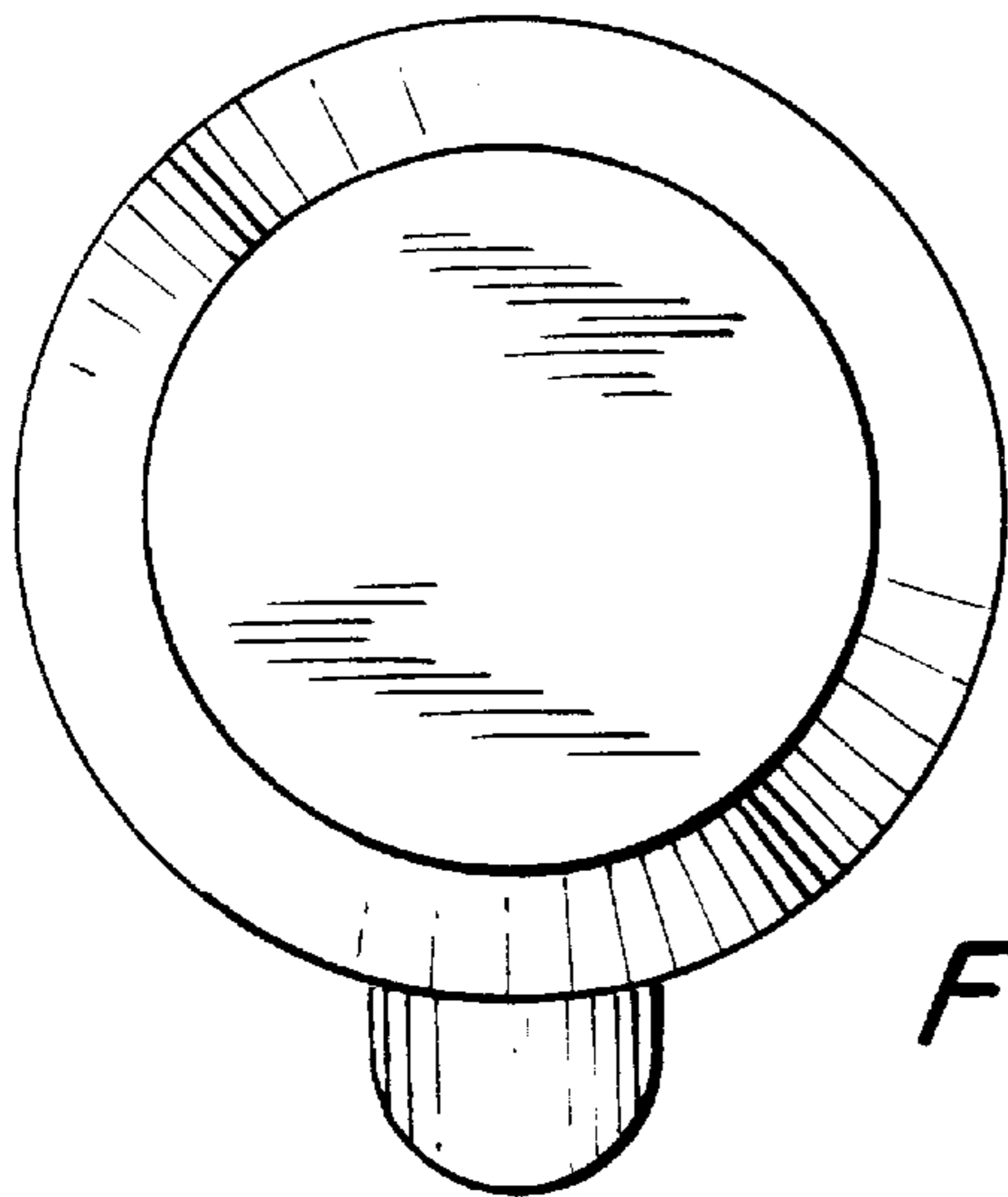


*FIG. 3*

*FIG.6*



*FIG.7*



*FIG.5*