



US00D407592S

# United States Patent [19]

Burdett et al.

[11] Patent Number: **Des. 407,592**

[45] Date of Patent: **\*\*Apr. 6, 1999**

[54] CONTAINER FOR RECORDED MEDIA

[75] Inventors: **Ronald K. Burdett**, Strasburg;  
**Nicholas M. Sedon**, Massillon; **Dennis D. Belden, Jr.**, Canton, all of Ohio

[73] Assignee: **Alpha Enterprises, Inc.**, North Canton, Ohio

[\*\*] Term: **14 Years**

[21] Appl. No.: **82,847**

[22] Filed: **Jan. 29, 1998**

[51] LOC (6) Cl. .... **06-04**

[52] U.S. Cl. .... **D6/632; D6/407; D6/634**

[58] Field of Search ..... D6/407, 626, 629,  
D6/631, 632, 634, 635; 206/387.1, 455,  
472, 308.3

### [56] References Cited

#### U.S. PATENT DOCUMENTS

D. 351,080	10/1994	Sykes et al. ....	D6/632
D. 352,860	11/1994	DuCorday .....	D6/632
D. 356,922	4/1995	DuCorday .....	D6/632
D. 358,961	6/1995	Lax .....	D6/632
D. 366,802	2/1996	Roberts et al. ....	D6/632
D. 373,044	8/1996	Kekuchi .....	D6/632
D. 378,333	3/1997	Anderson .....	D6/632

D. 380,927	7/1997	Williams et al. ....	D6/632
1,566,041	12/1925	Schaus .....	206/472
4,593,814	6/1986	Hagiwara et al. ....	206/387.1
4,635,797	1/1987	Bankier .....	206/472
5,016,752	5/1991	Haugen, Jr. ....	206/455

*Primary Examiner*—Celia Murphy  
*Attorney, Agent, or Firm*—Sand & Sebolt

### [57] CLAIM

The ornamaental design for a container for recorded media, as shown and described.

### DESCRIPTION

FIG. 1 is a front perspective view of the container for recorded media showing our new design;  
 FIG. 2 is a top plan view thereof, the bottom being a mirror image;  
 FIG. 3 is a front elevational view thereof;  
 FIG. 4 is a rear elevational view thereof;  
 FIG. 5 is a right side elevational view thereof, the left side being a mirror image;  
 FIG. 6 is a front elevational of a second embodiment thereof with the top, bottom and sides being the same as FIGS. 2, 4 and 5; and,  
 FIG. 7 is a front elevational view of a third embodiment thereof with the top, bottom and sides being the same FIGS. 2, 4 and 5.

**1 Claim, 3 Drawing Sheets**

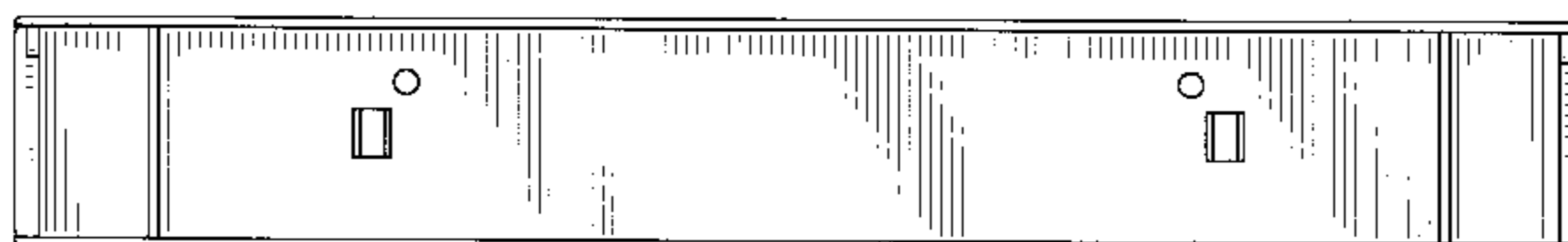
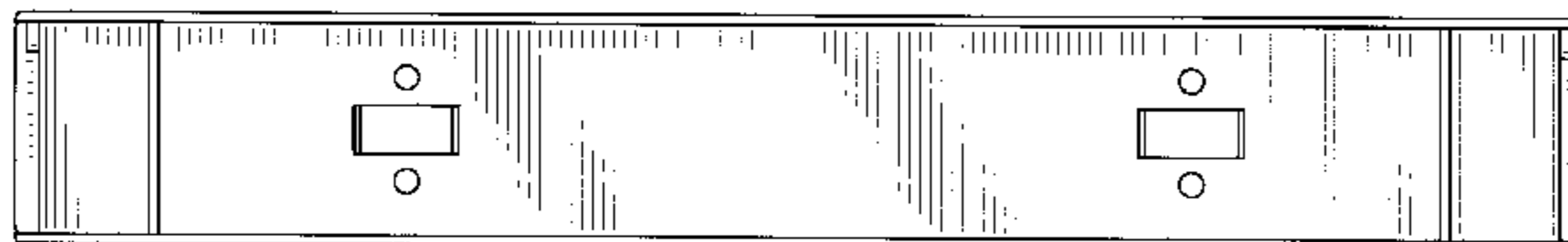
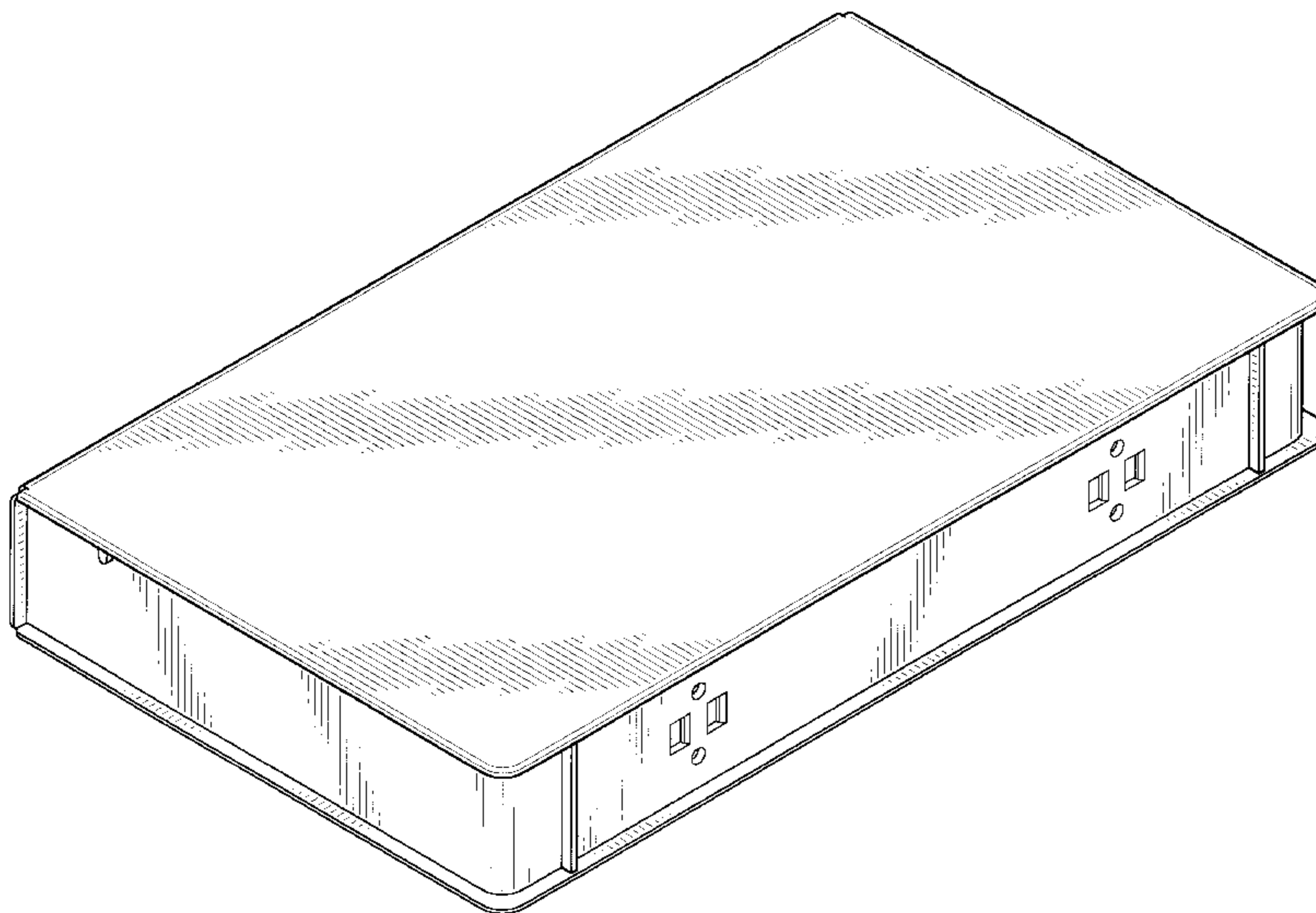

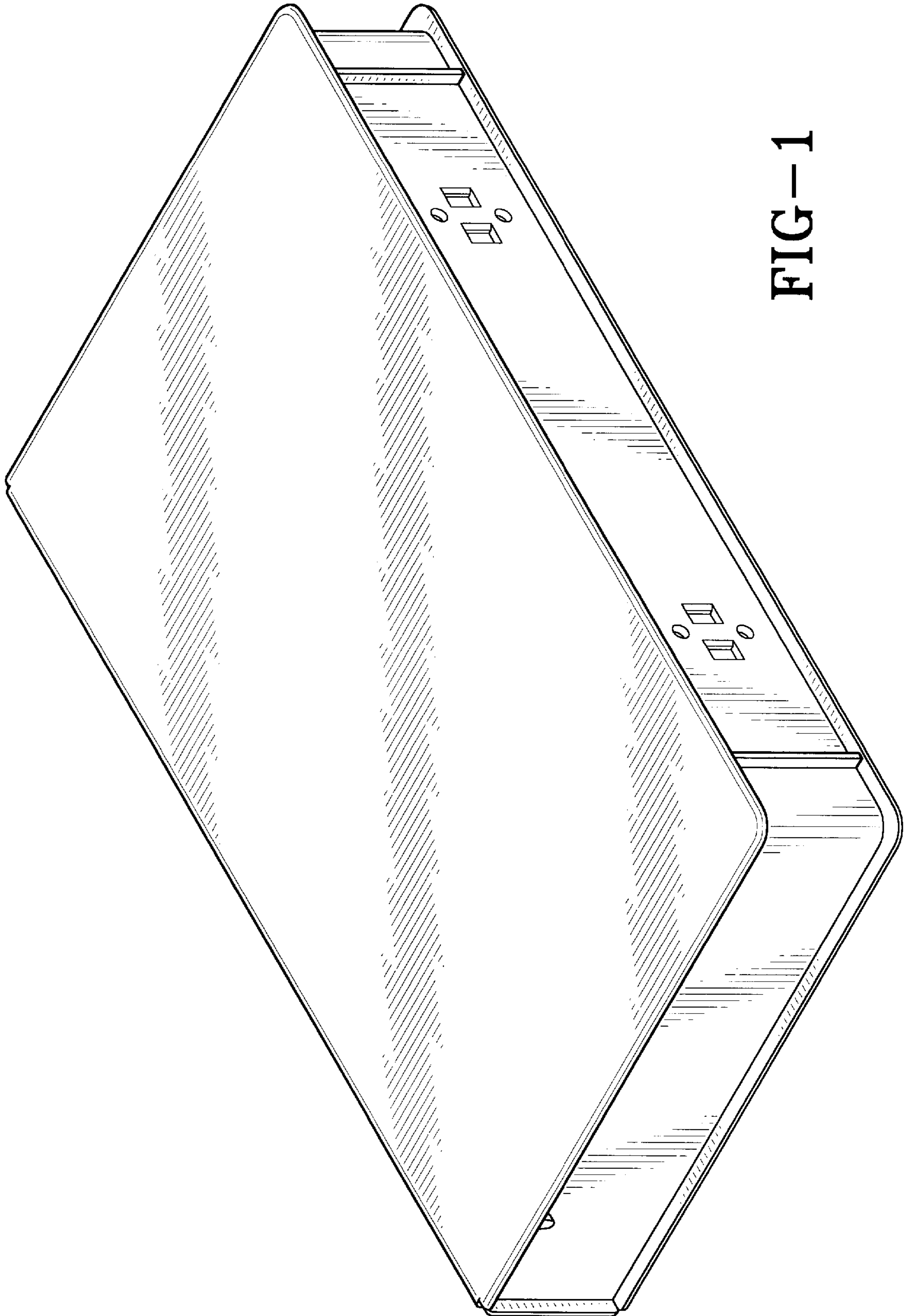

FIG-1

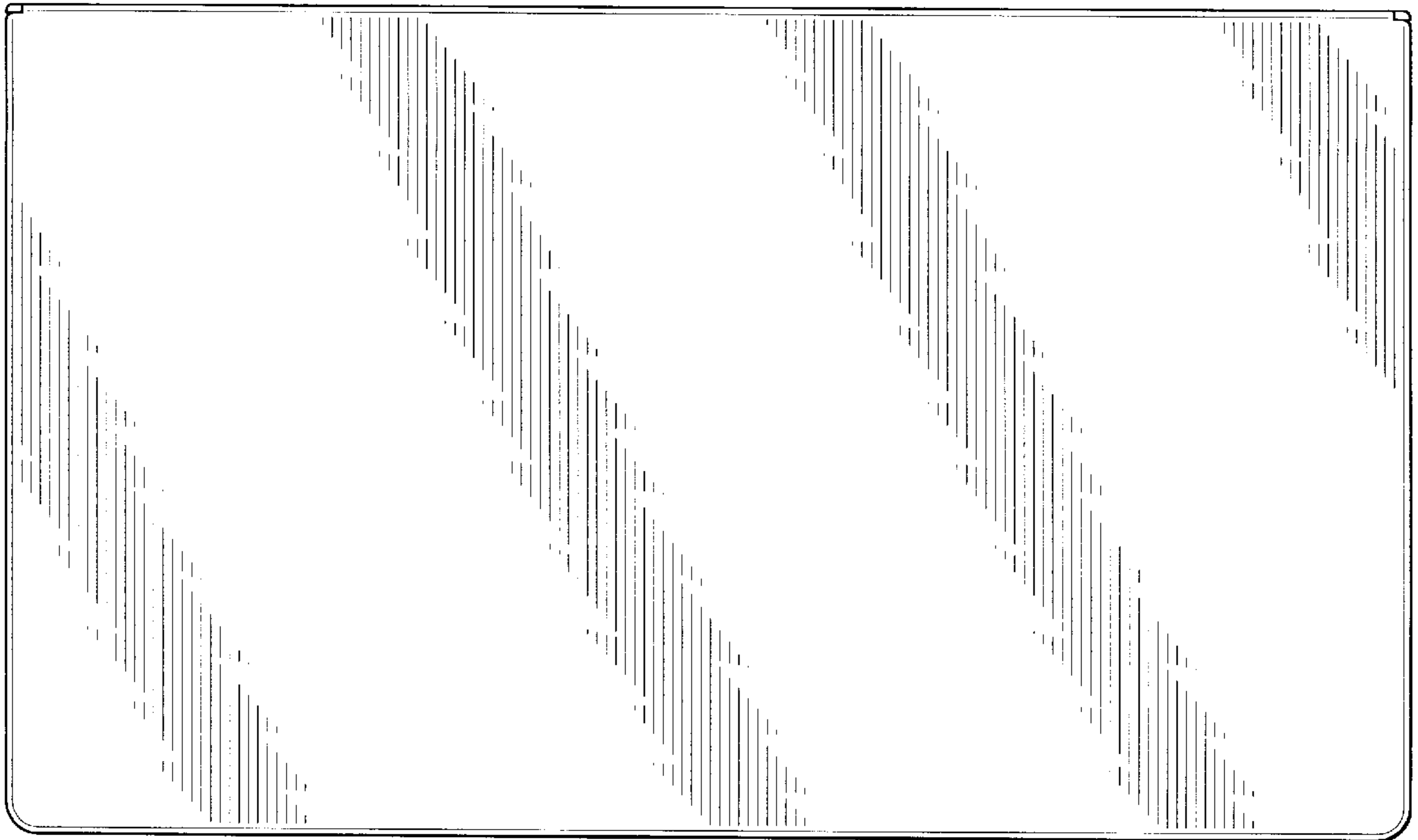

FIG-2

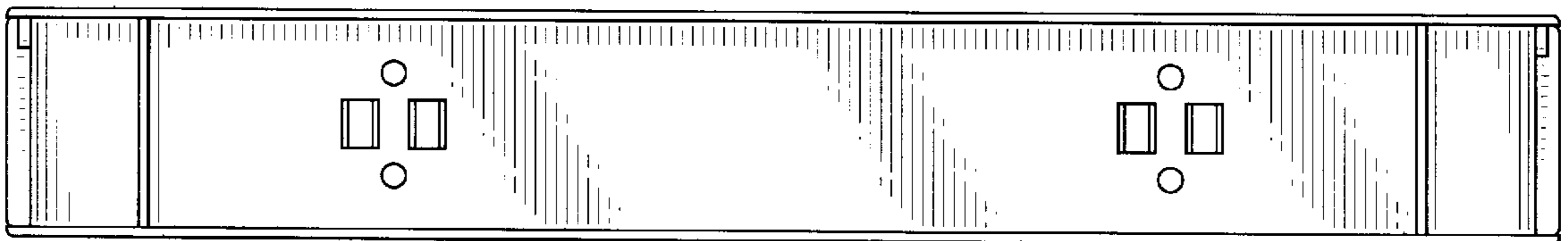

FIG-3

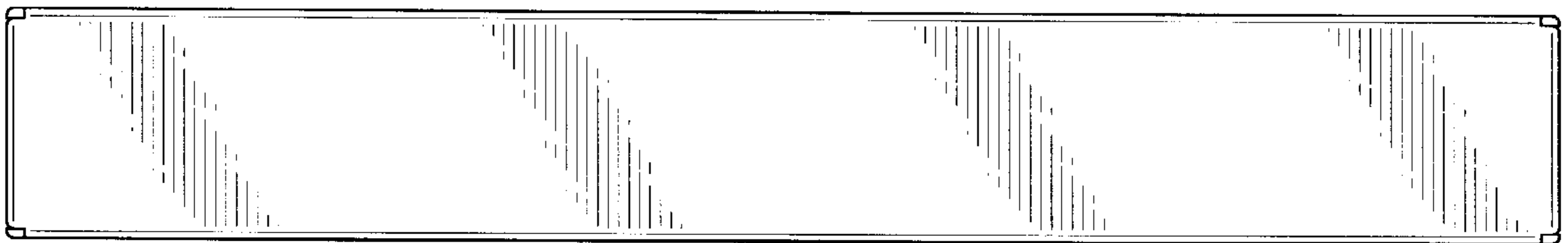

FIG-4

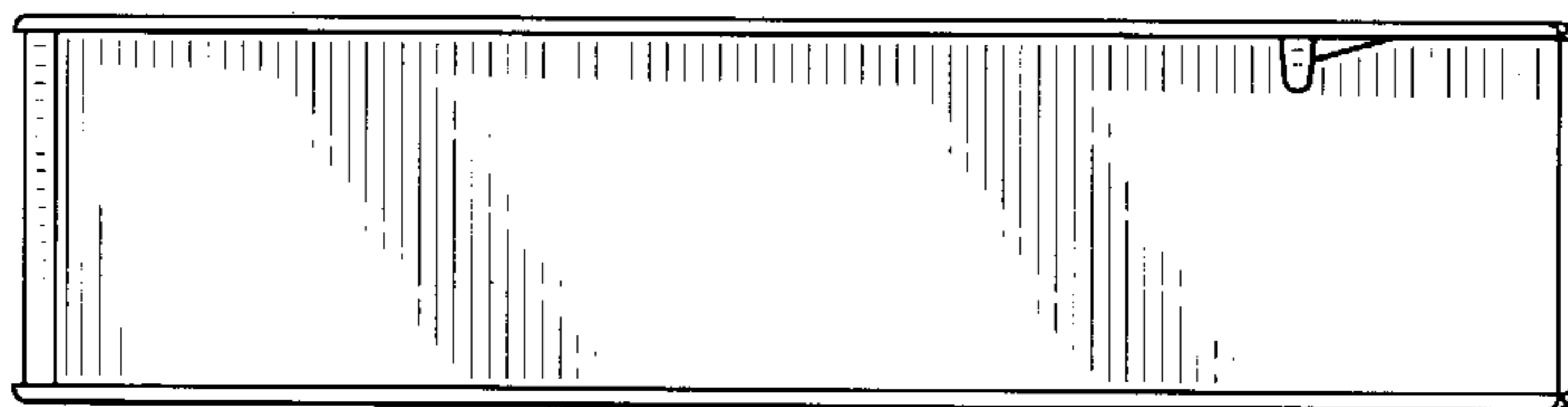

FIG-5

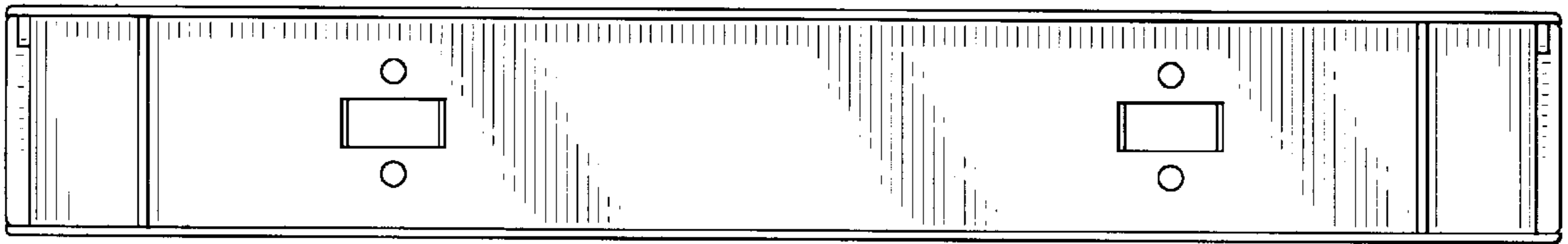

FIG-6

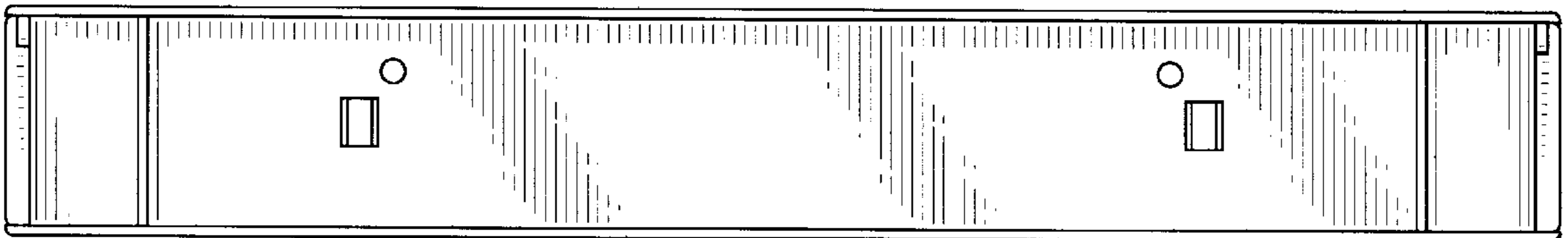

FIG-7