



US00D407511S

United States Patent [19] Wright et al.

[11] **Patent Number: Des. 407,511**

[45] **Date of Patent: **Mar. 30, 1999**

[54] **BABY CARRIAGE LIGHT**

D. 368,316 3/1996 Jansson D26/39
D. 393,087 3/1998 Johnston et al. D26/39

[76] Inventors: **Peter A. Wright**, 34A, Elphinstone Rd., Hastings, E. Sussex, United Kingdom, TN34 2EQ; **Kevin John Jeffery**, 17A De Cham Road, St. Leonards-On-Sea, Sussex, United Kingdom, TN37 6JP

Primary Examiner—Marcus A. Jackson
Attorney, Agent, or Firm—Rader, Fishman & Grauer, PLLC.

[**] Term: **14 Years**

[57] CLAIM

The ornamental design for a baby carriage light, as shown and described.

[21] Appl. No.: **90,747**

DESCRIPTION

[22] Filed: **Jul. 15, 1998**

[51] **LOC (6) Cl.** **26-02**

[52] **U.S. Cl.** **D26/39**

[58] **Field of Search** D26/37-50; 362/103, 362/105, 106, 154, 156, 157, 158, 183, 184, 186-208

FIG. 1 is a view of the front face of the baby carriage light; FIG. 2 is a view of the reverse face of the baby carriage light; FIG. 3 is a view of the right face of the baby carriage light; FIG. 4 is a view of the left face of the baby carriage light; FIG. 5 is a view of the top face of the baby carriage light; FIG. 6 is a view of the bottom face of the baby carriage light; and, FIG. 7 is an isometric view of the baby carriage light.

[56] References Cited

U.S. PATENT DOCUMENTS

D. 274,758 7/1984 Shing D26/39

1 Claim, 4 Drawing Sheets

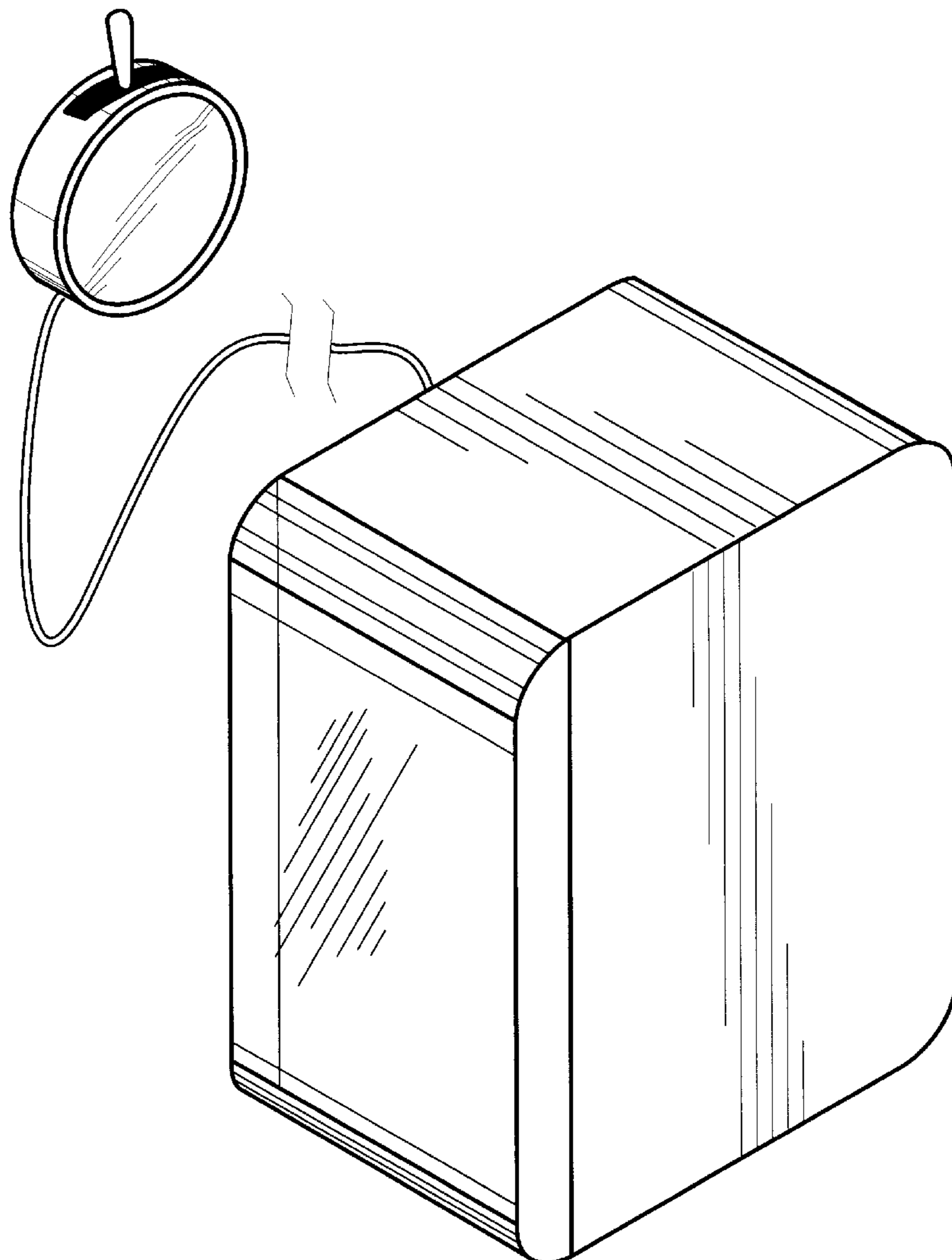

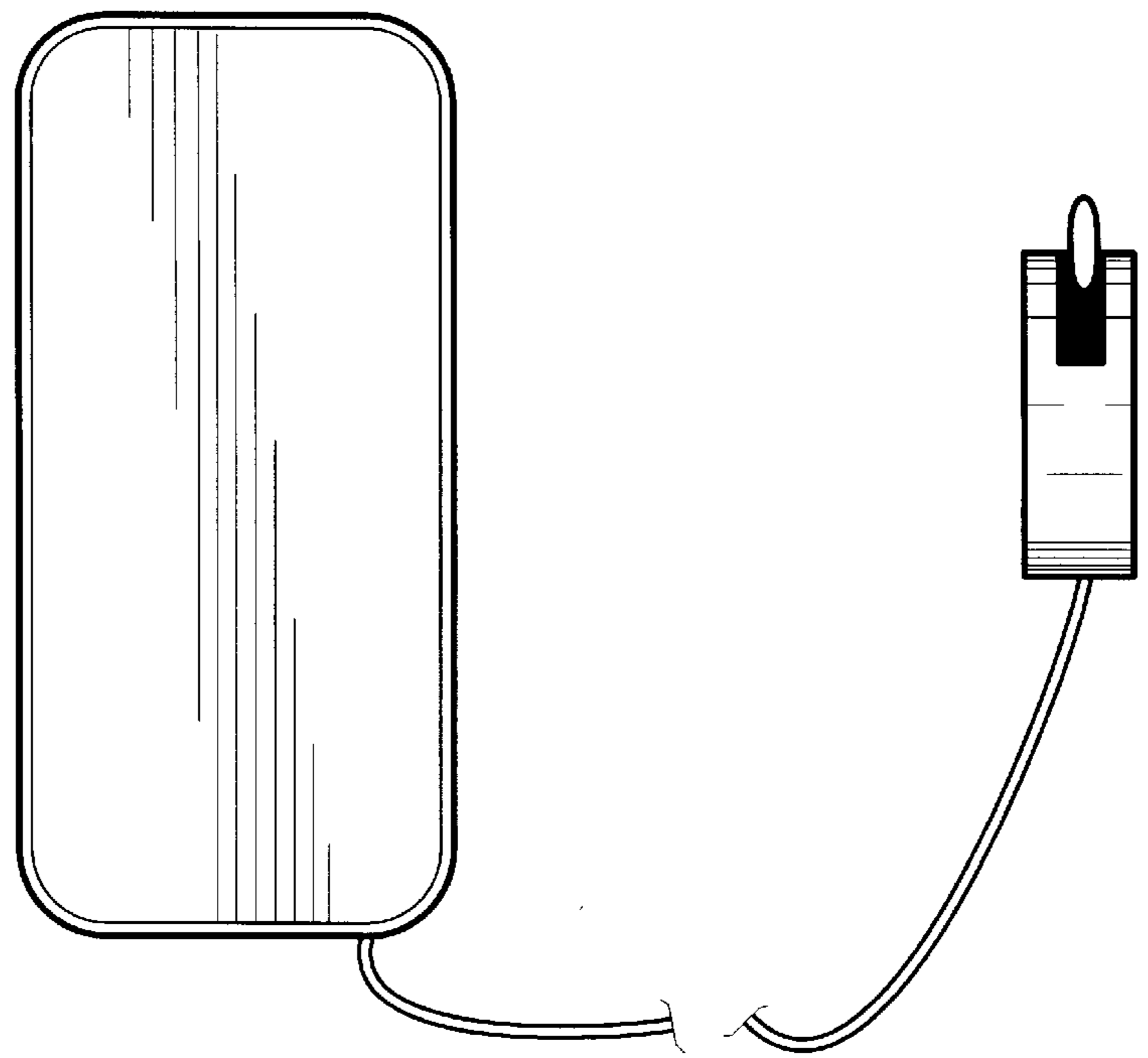

FIG 1

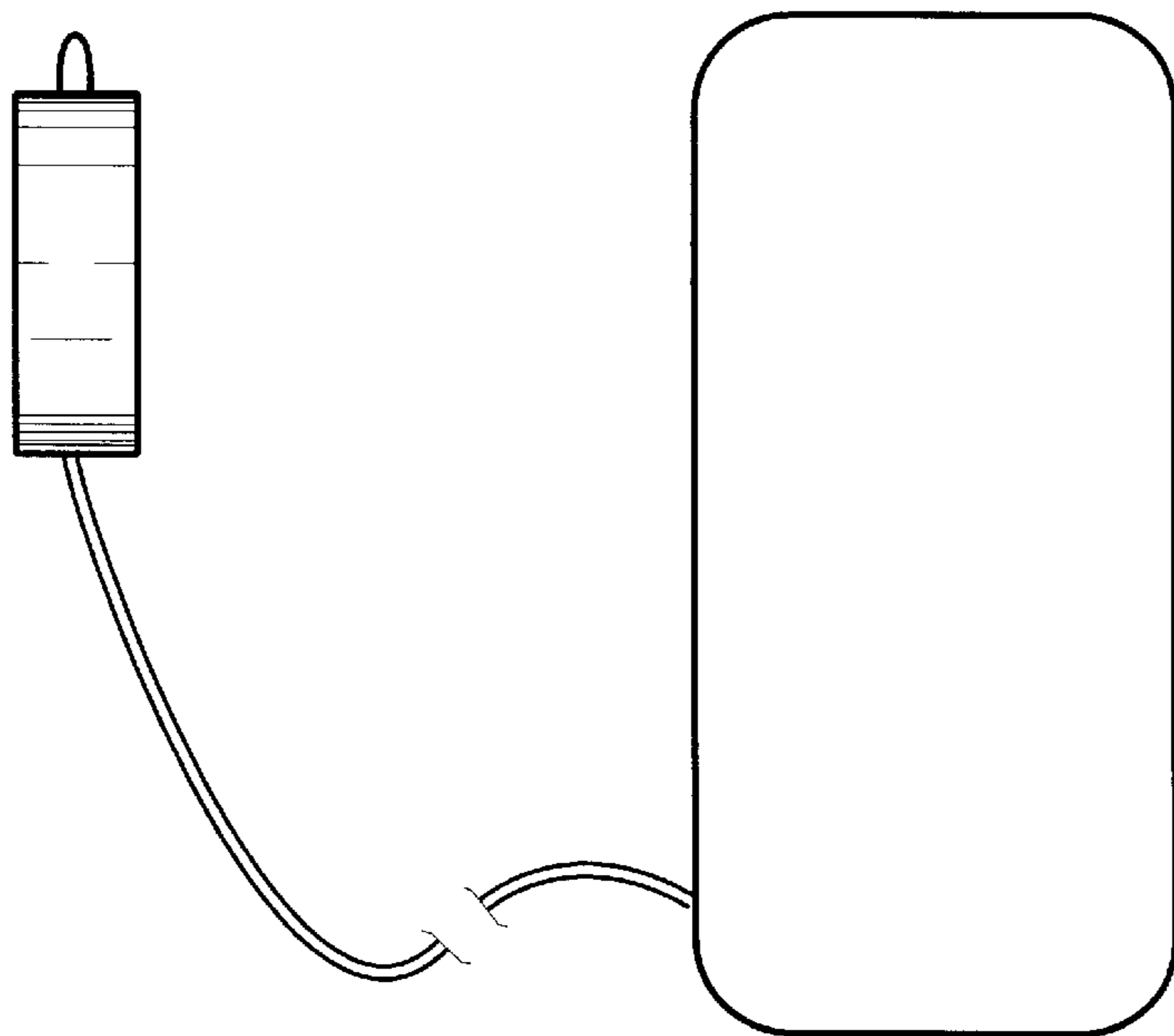

FIG 2

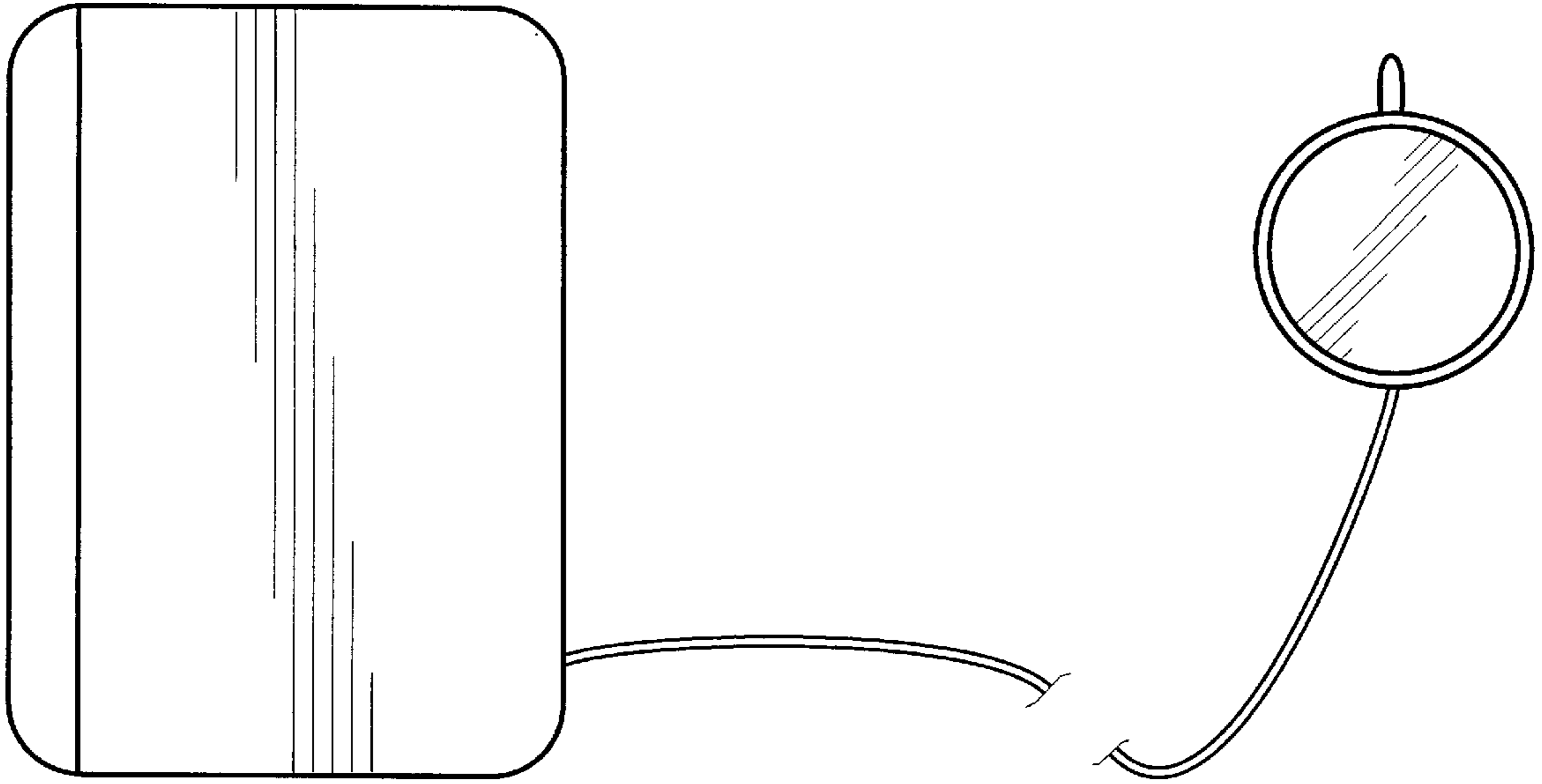

FIG 3

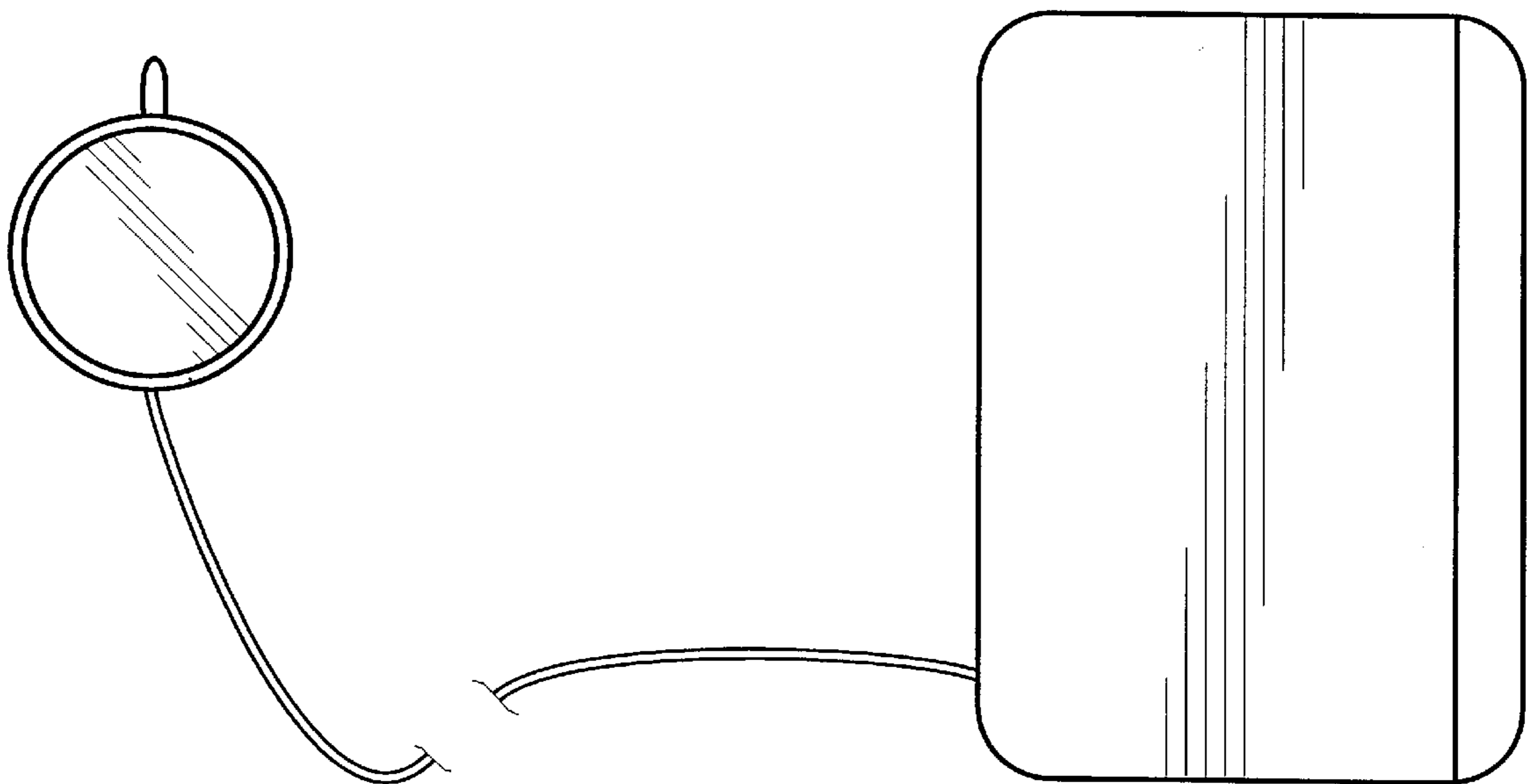

FIG 4

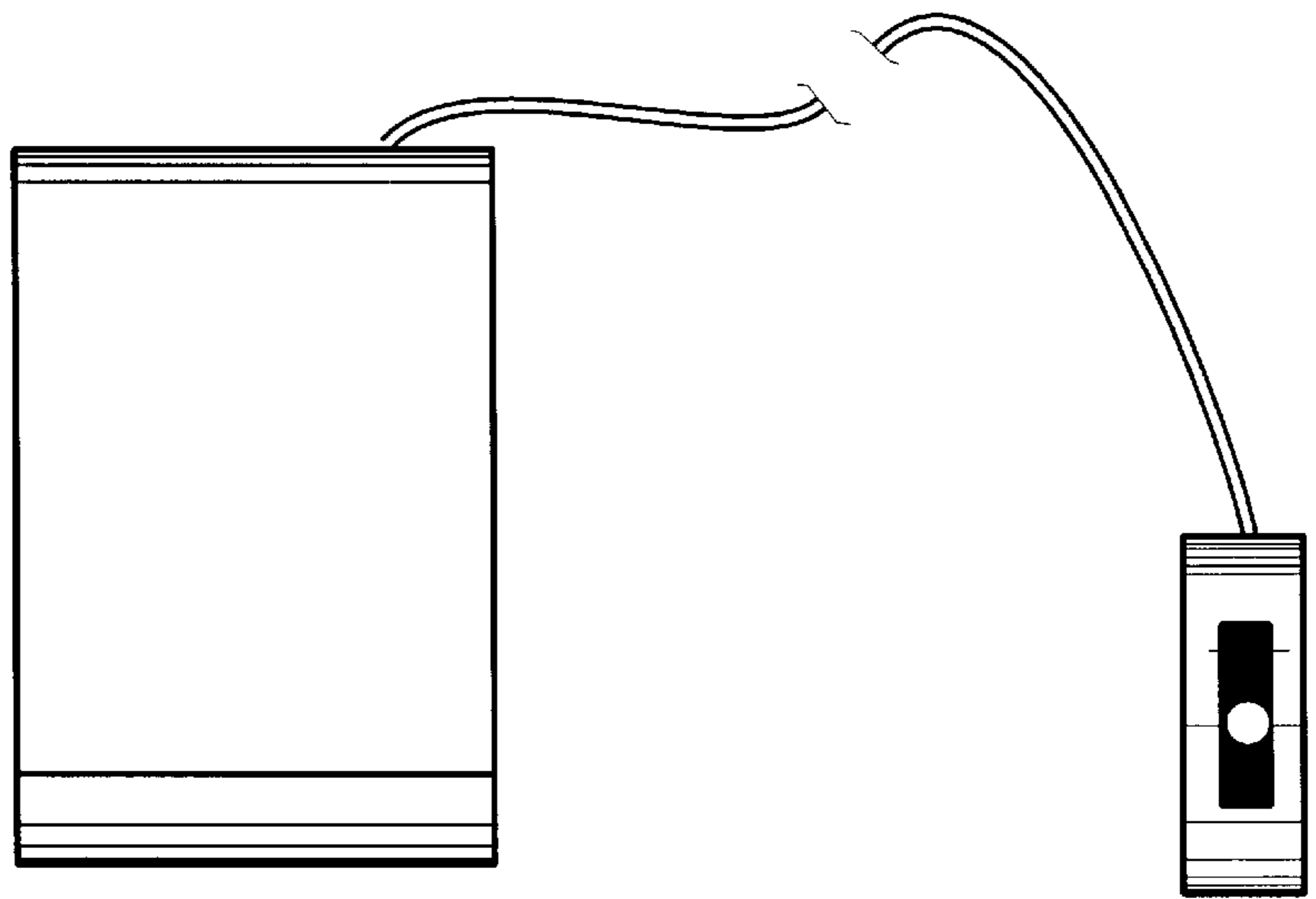

FIG 5

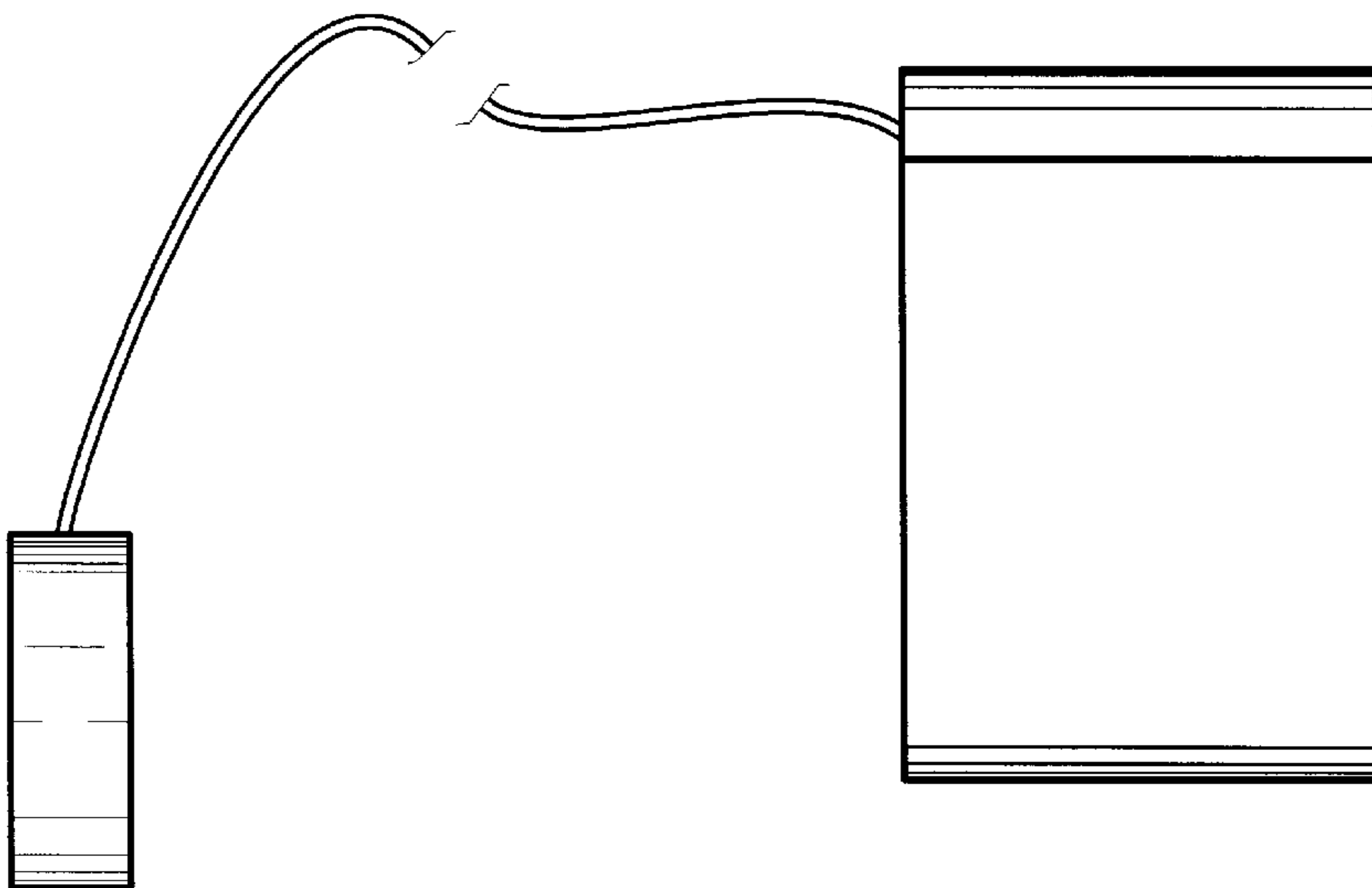

FIG 6

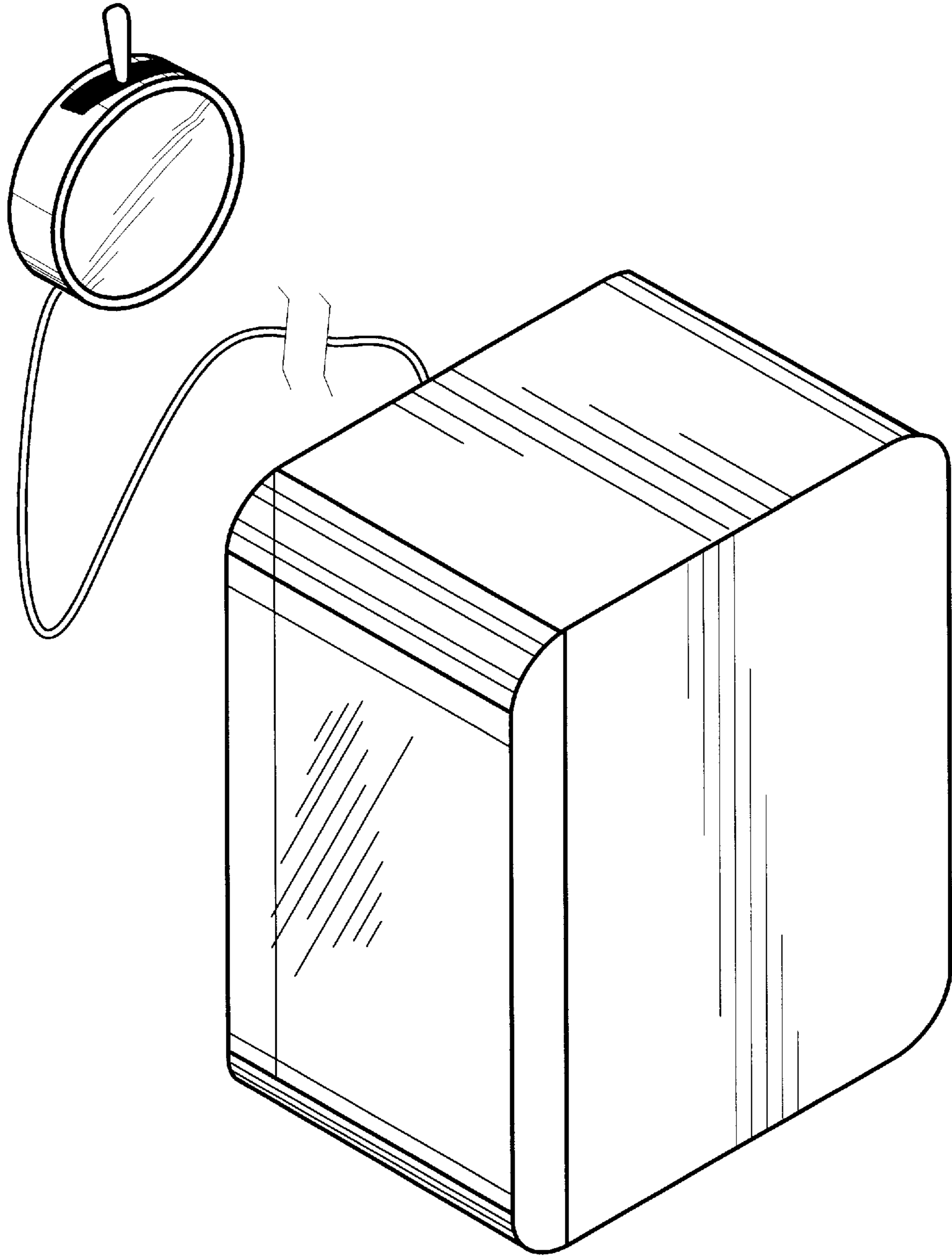

FIG 7