



US00D407438S

United States Patent [19]

Kelders et al.

[11] **Patent Number: Des. 407,438**

[45] **Date of Patent: **Mar. 30, 1999**

[54] **HOLDER WITH CORRECTING TAPE**

[75] Inventors: **Johannes H. J. M. Kelders**, Drunen;
Roy E. van Swieten, Heusden, both of
Netherlands

[73] Assignee: **Henkel KGaA**, Germany

[**] Term: **14 Years**

[21] Appl. No.: **90,036**

[22] Filed: **Jun. 29, 1998**

[30] **Foreign Application Priority Data**

Dec. 31, 1997 [XH] Hague Agreement DM/042 835

[51] **LOC (6) Cl.** **19-02**

[52] **U.S. Cl.** **D19/69; D19/67**

[58] **Field of Search** D19/65, 53, 66,
D19/67, 68, 69, 99, 100; 242/588, 588.3,
590, 159; 225/6.7, 25, 19, 24, 34, 35, 45,
56, 65, 77, 89; 156/510, 523, 527, 577,
584

[56] **References Cited**

U.S. PATENT DOCUMENTS

D. 328,097 7/1992 Czech D19/69

D. 370,692	6/1996	Crawford et al.	D19/67 X
D. 396,061	7/1998	Thompson et al.	D19/69
2,582,980	1/1952	Fritzinger	156/523
4,486,263	12/1984	Gomez	156/523
4,997,512	3/1991	Manusch	156/577 X
5,181,983	1/1993	Sakai	156/523
5,707,482	1/1998	Fusselman	156/577

Primary Examiner—Martie K. Holtje
Attorney, Agent, or Firm—Hill & Simpson

[57] **CLAIM**

The ornamental design for a holder with correcting tape, as shown.

DESCRIPTION

FIG. 1 is a left front perspective view of a holder with correcting tape showing our new design;
FIG. 2 is a front elevational view;
FIG. 3 is a left side elevational view;
FIG. 4 is a rear elevational view;
FIG. 5 is a right side elevational view;
FIG. 6 is a top plan view; and,
FIG. 7 is a bottom plan view thereof.

1 Claim, 1 Drawing Sheet

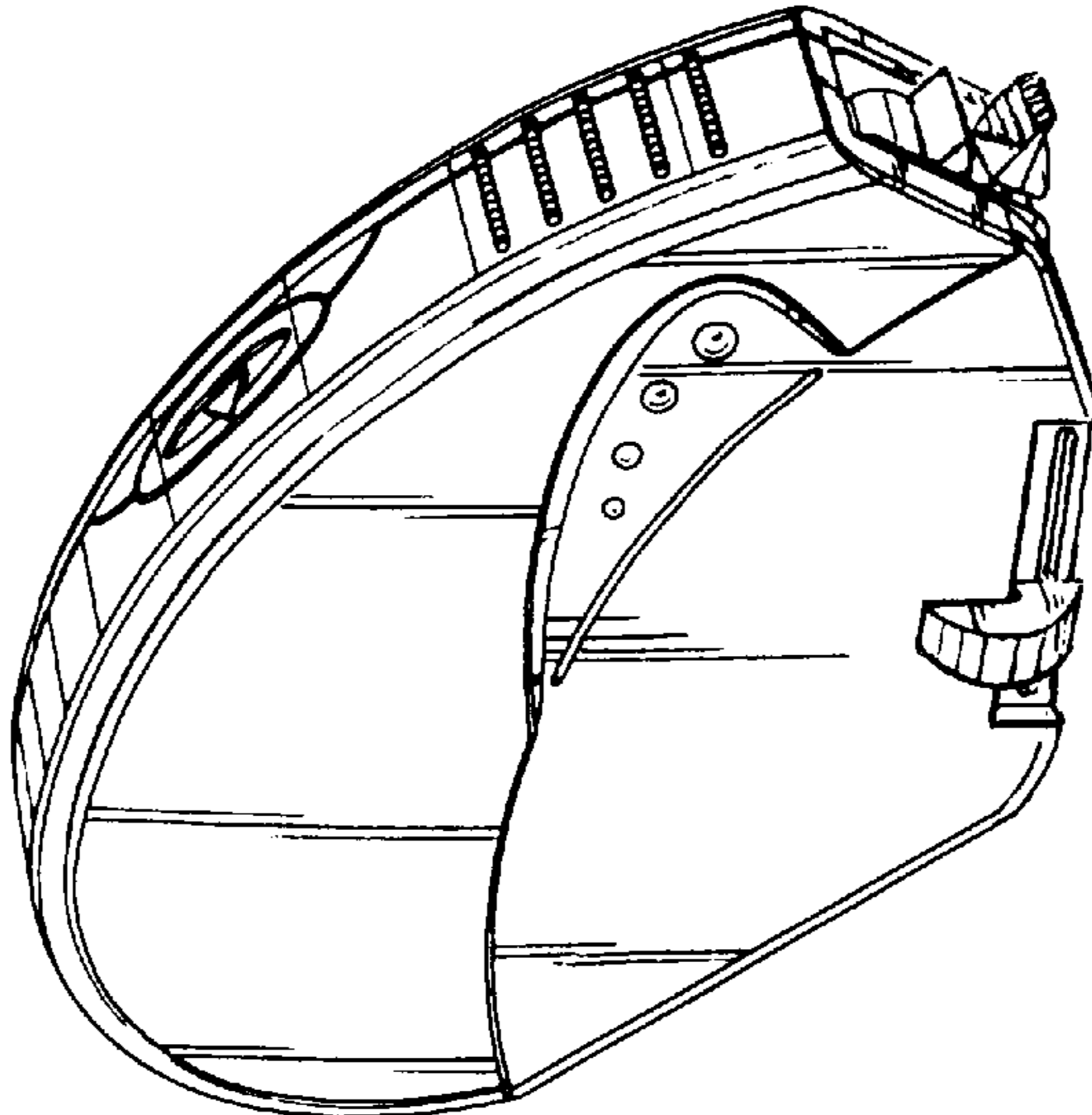

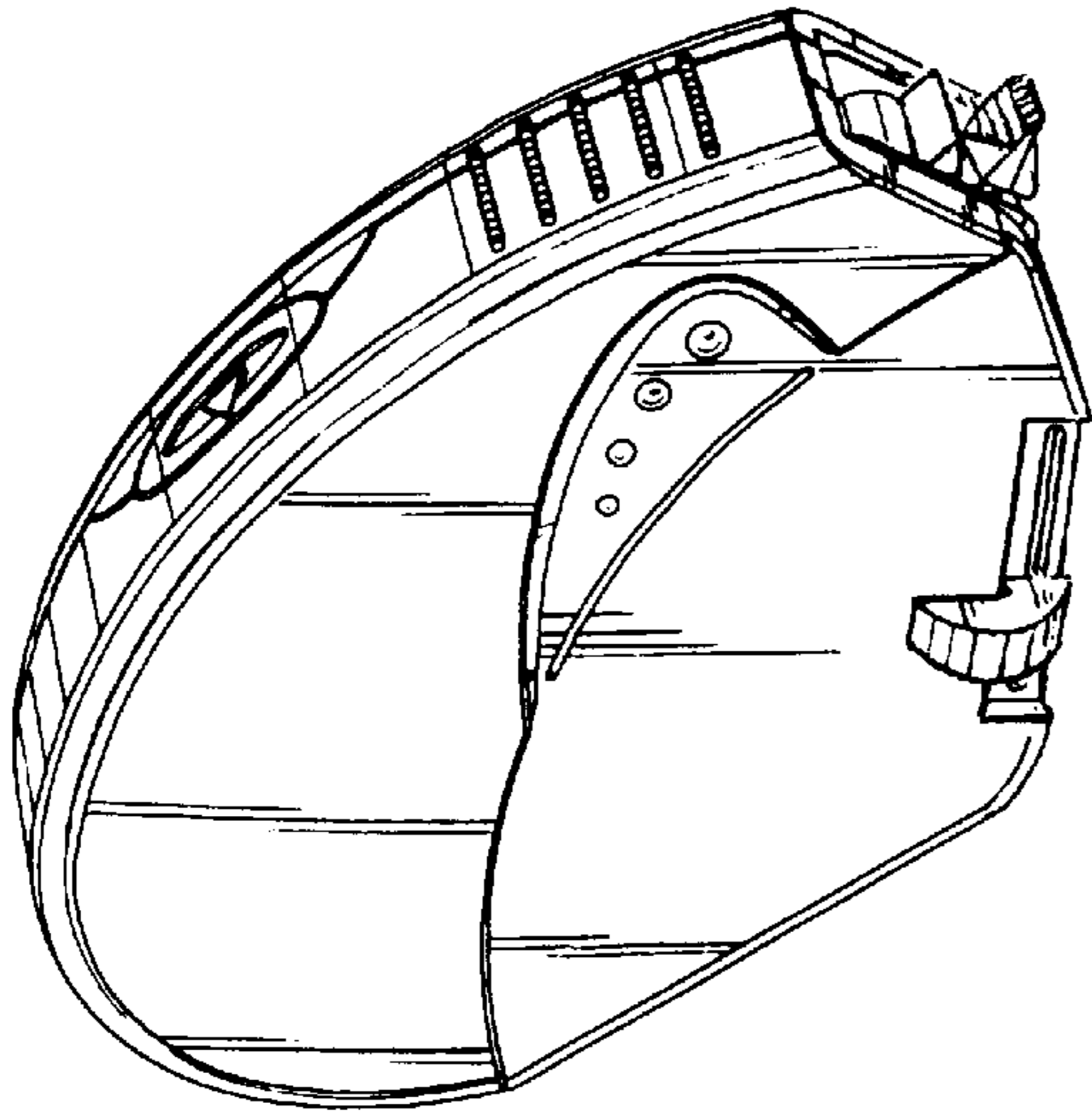

FIG. 1

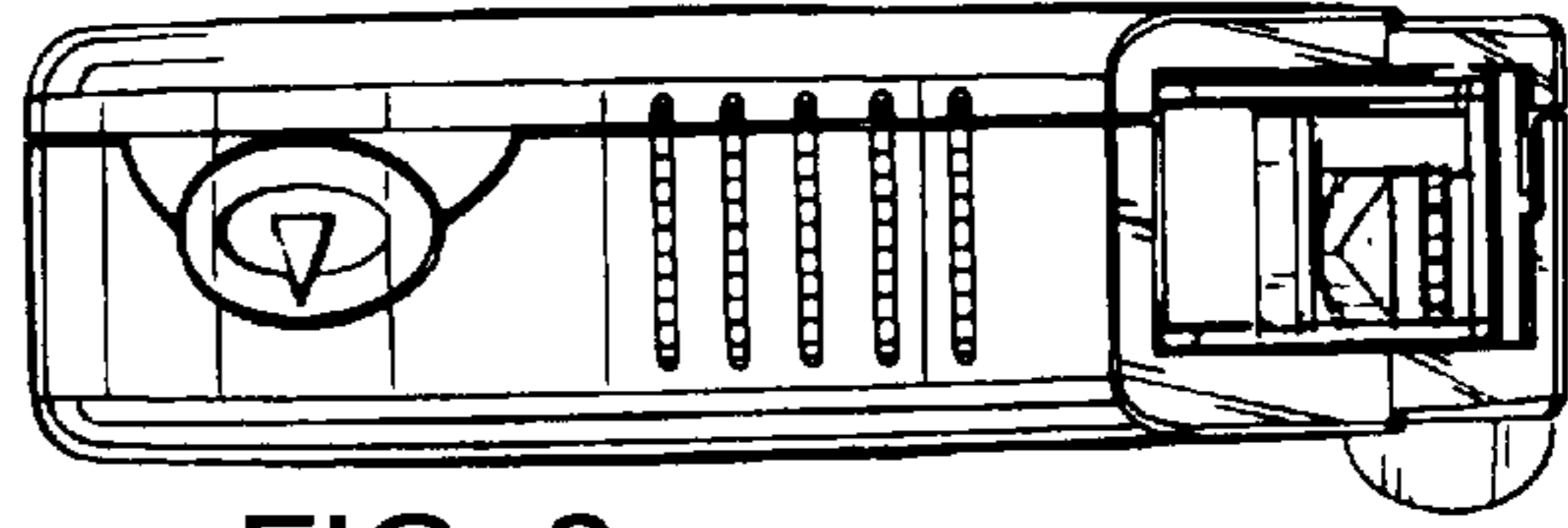

FIG. 2

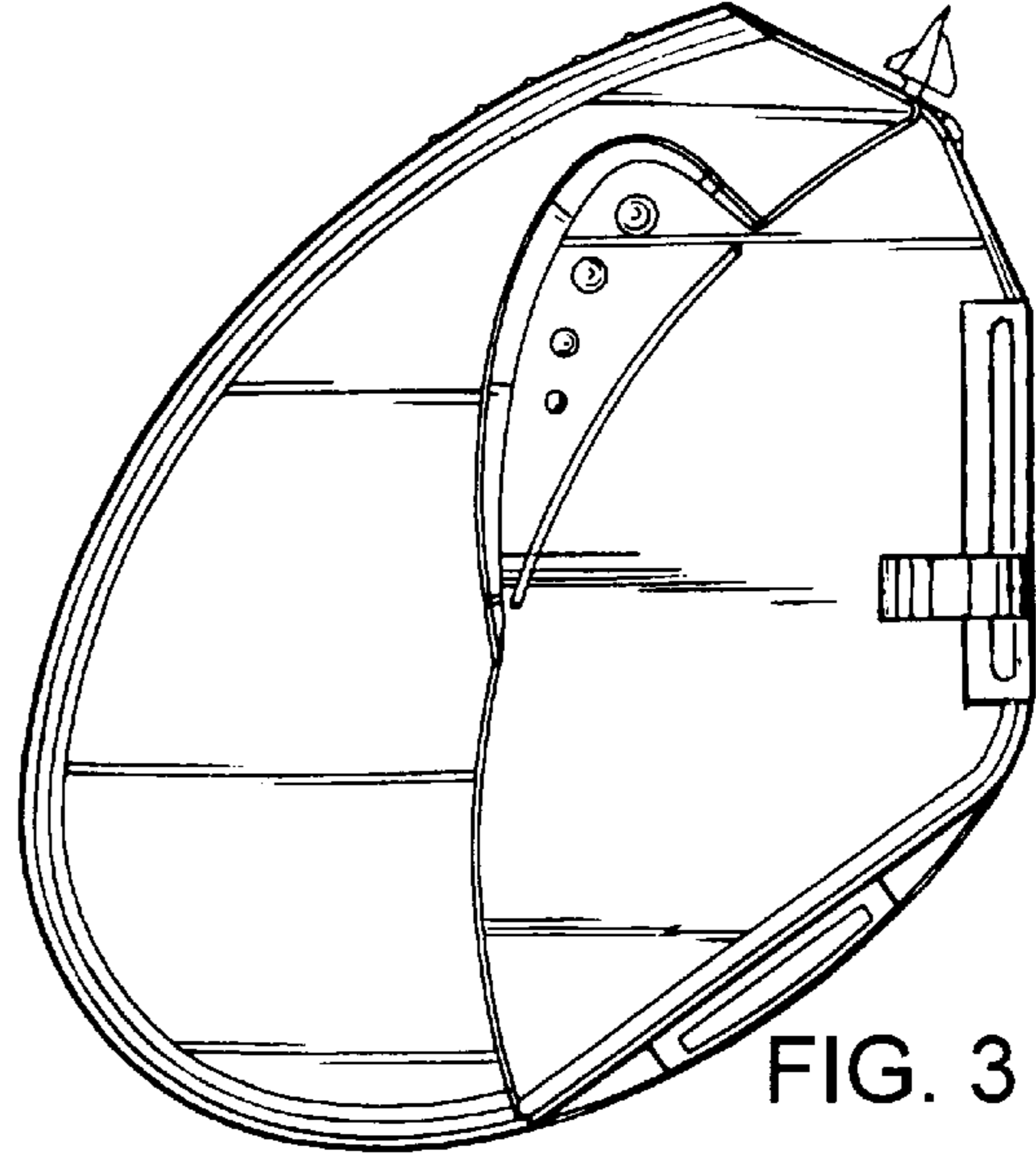

FIG. 3

FIG. 4

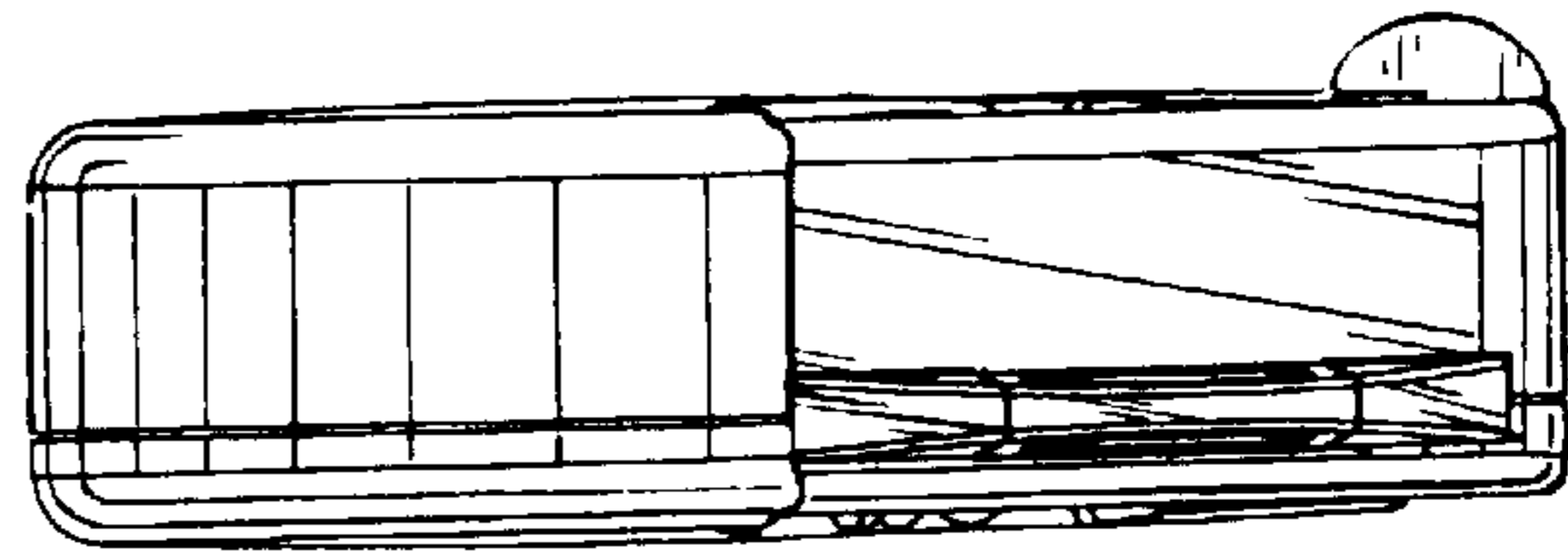

FIG. 7

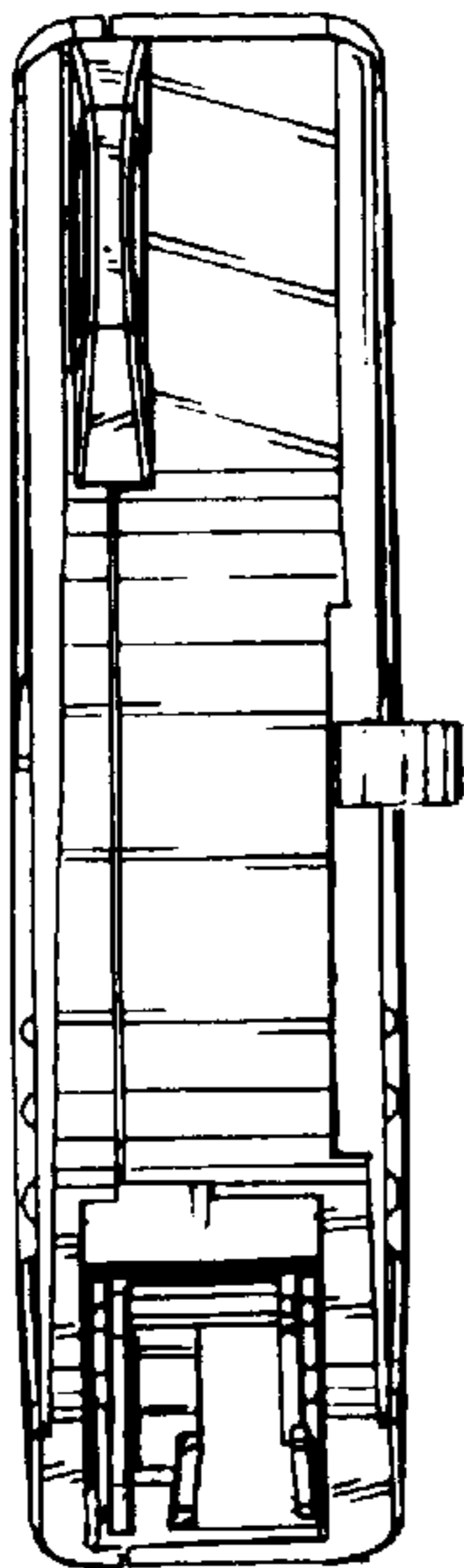

FIG. 6

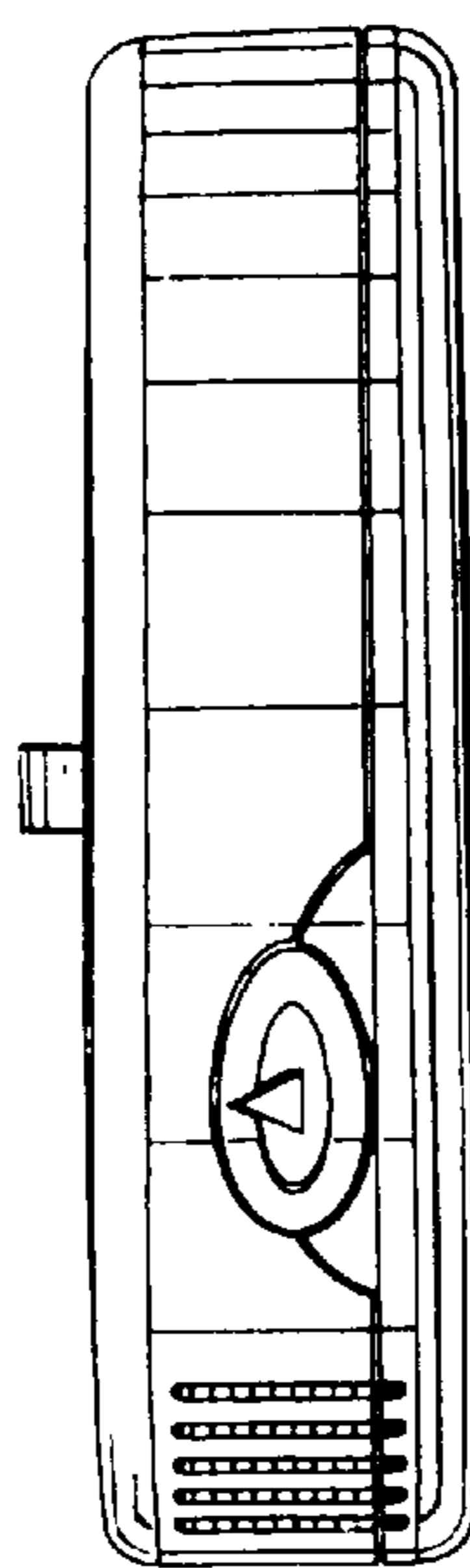

FIG. 5

