



US00D407396S

United States Patent [19] Ogasawara

[11] Patent Number: Des. 407,396

[45] Date of Patent: **Mar. 30, 1999

[54] **WIRELESS TELEPHONE**

[75] Inventor: **Shinichi Ogasawara**, Tokyo, Japan

[73] Assignee: **Sony Corporation**, Tokyo, Japan

[**] Term: **14 Years**

[21] Appl. No.: **79,156**

[22] Filed: **Nov. 17, 1997**

[30] **Foreign Application Priority Data**

May 30, 1997 [JP] Japan 9-56410

[51] **LOC (6) Cl.** **14-03**

[52] **U.S. Cl.** **D14/138**

[58] **Field of Search** D14/137, 138,
D14/147-148, 247-248, 250, 240, 140-142;
379/433, 434, 419, 420, 428, 440; 455/500-575,
90

[56] **References Cited**

U.S. PATENT DOCUMENTS

D. 328,902	8/1992	Lee	D14/218
D. 330,024	10/1992	Peersmann	D14/147
D. 346,171	4/1994	Ratcliffe	D14/248
D. 364,616	11/1995	Oda et al.	D14/138
D. 391,568	3/1998	Carlson	D14/138
5,109,539	4/1992	Inubushi et al.	455/575
5,151,946	9/1992	Martensson	455/550

OTHER PUBLICATIONS

Sony Style, p. 174, SPP-S20 cordless telephone, fall 1996.

Primary Examiner—Jeffrey Asch
Attorney, Agent, or Firm—Foley & Lardner

[57] **CLAIM**

The ornamental design for a wireless telephone, as shown and described.

DESCRIPTION

FIG. 1 is a perspective view of a first embodiment of a wireless telephone, which is in use, showing my new design; FIG. 2 is a top plan view thereof; FIG. 3 is a left side elevational view thereof; FIG. 4 is a front elevational view thereof; FIG. 5 is a bottom plan view thereof; FIG. 6 is a right side elevational view thereof; FIG. 7 is a rear elevational view thereof; FIG. 8 is another perspective view thereof wherein the wireless telephone is not in the extended position for use; FIG. 9 is a perspective view of a second embodiment of a wireless telephone showing my new design; FIG. 10 is a top plan view thereof; FIG. 11 is a left side elevational view thereof; FIG. 12 is a front elevational view thereof; FIG. 13 is a bottom plan view thereof; FIG. 14 is a right side elevational view thereof; FIG. 15 is a rear elevational view thereof; FIG. 16 is another perspective view thereof wherein the wireless telephone is not in the extended position for use; and, FIG. 17 is a front elevational view thereof wherein the keypad is shown with broken lines for illustrative purposes only, forming no part of the claimed design.

1 Claim, 8 Drawing Sheets

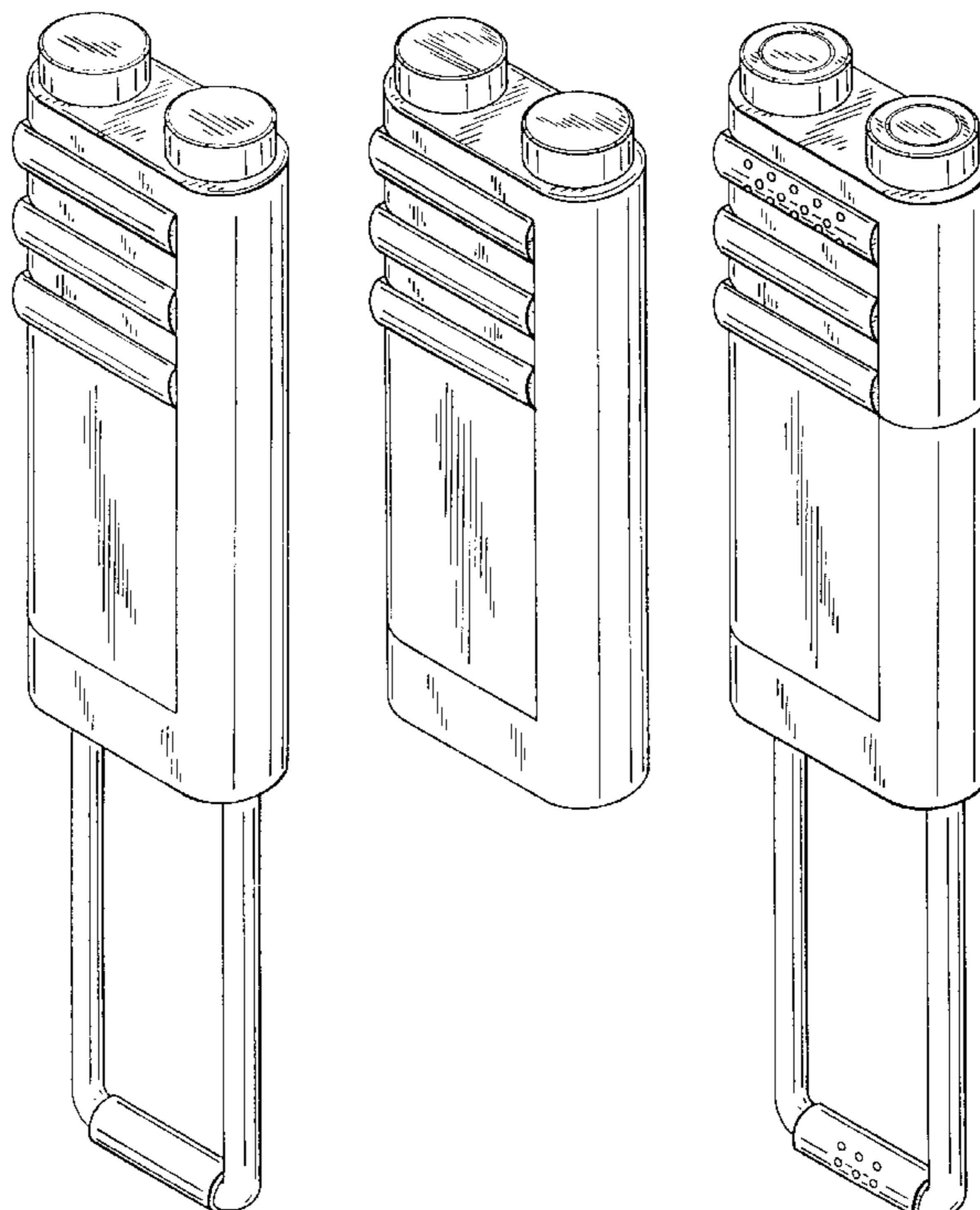

FIG. 1

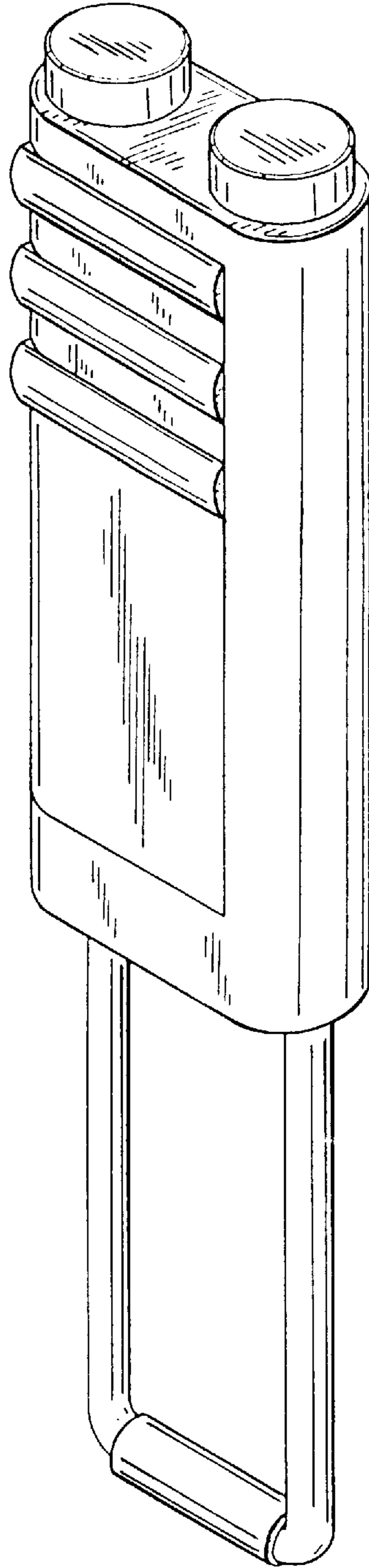

FIG. 2

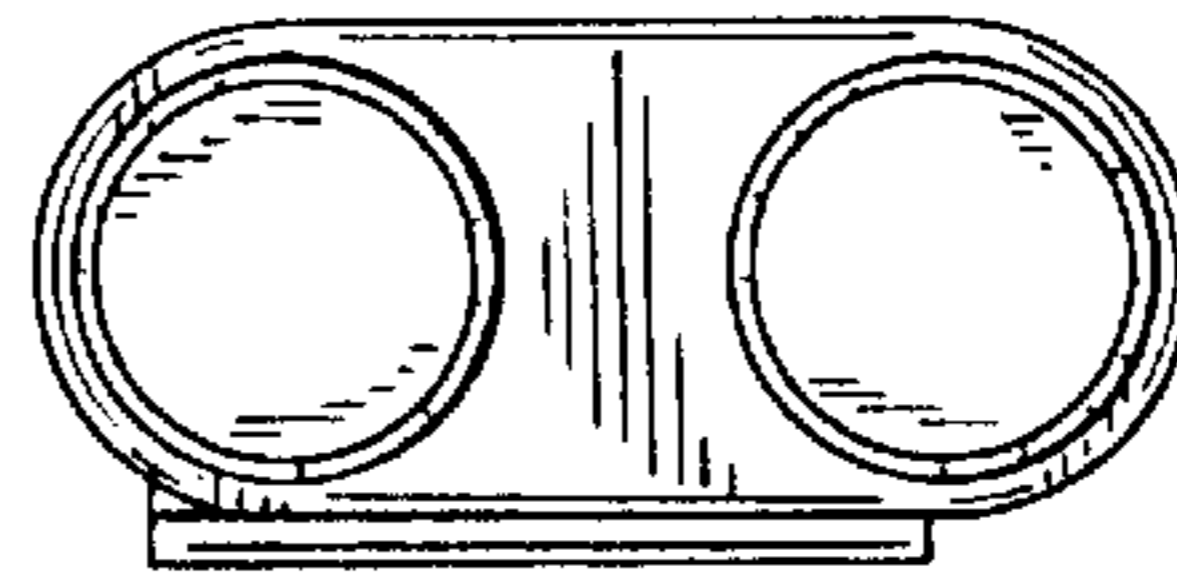

FIG. 3

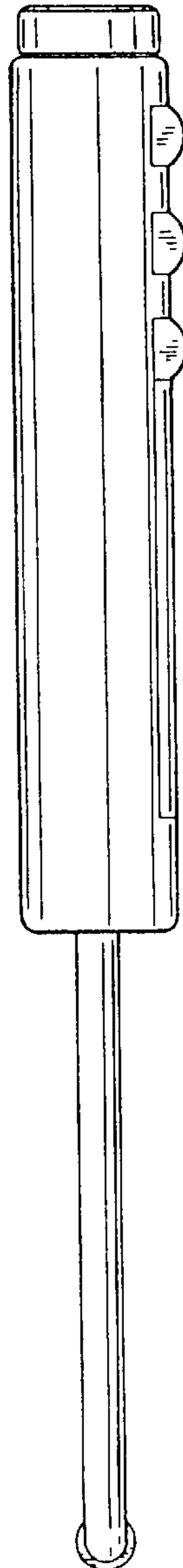

FIG. 4

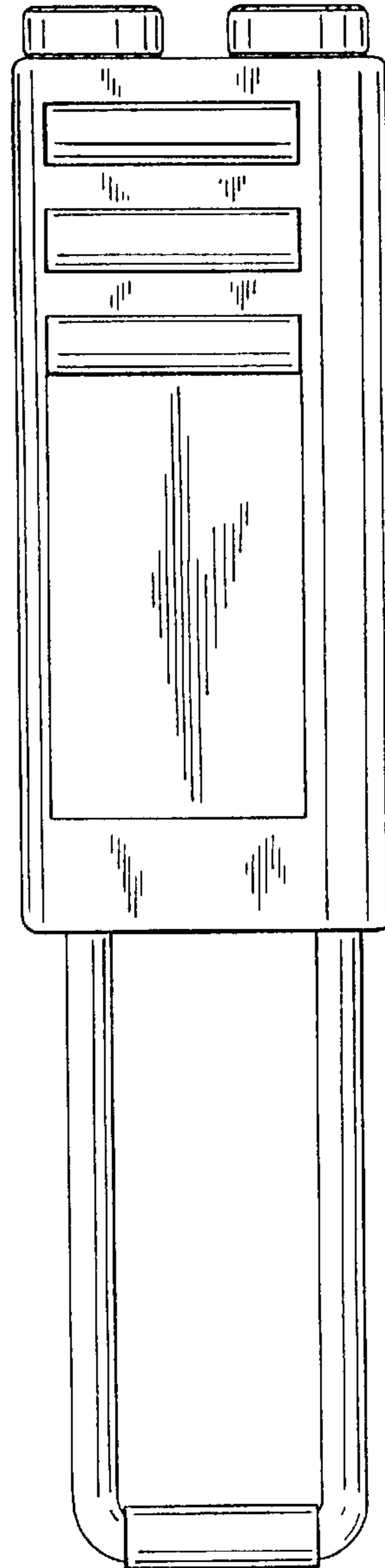

FIG. 5

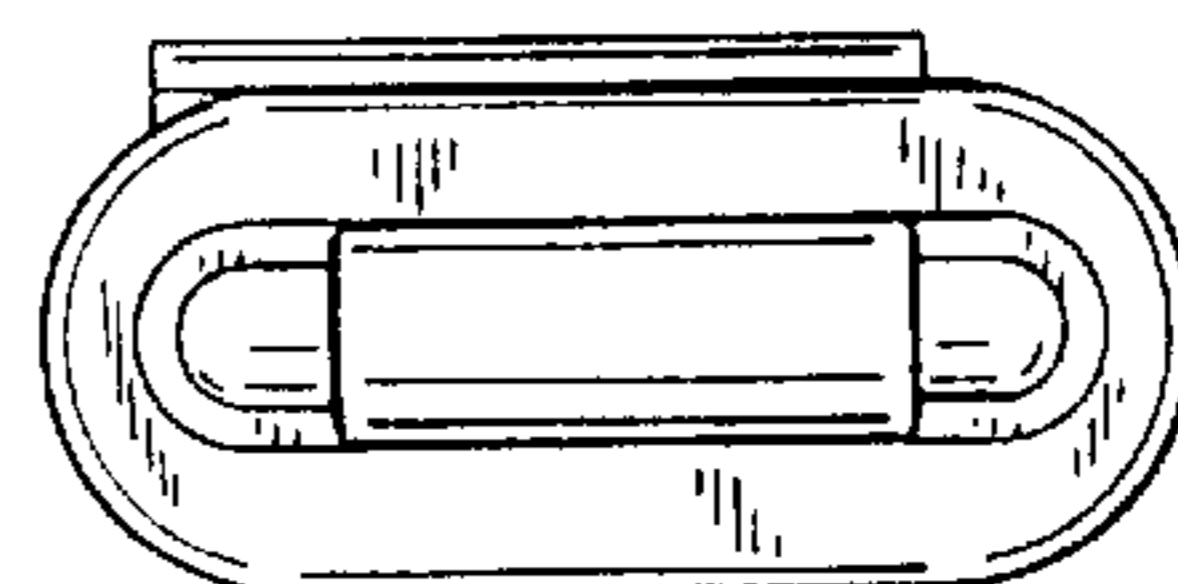

FIG. 6

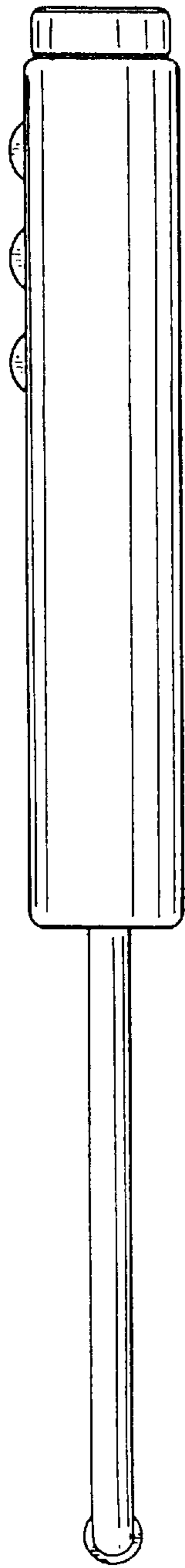

FIG. 7

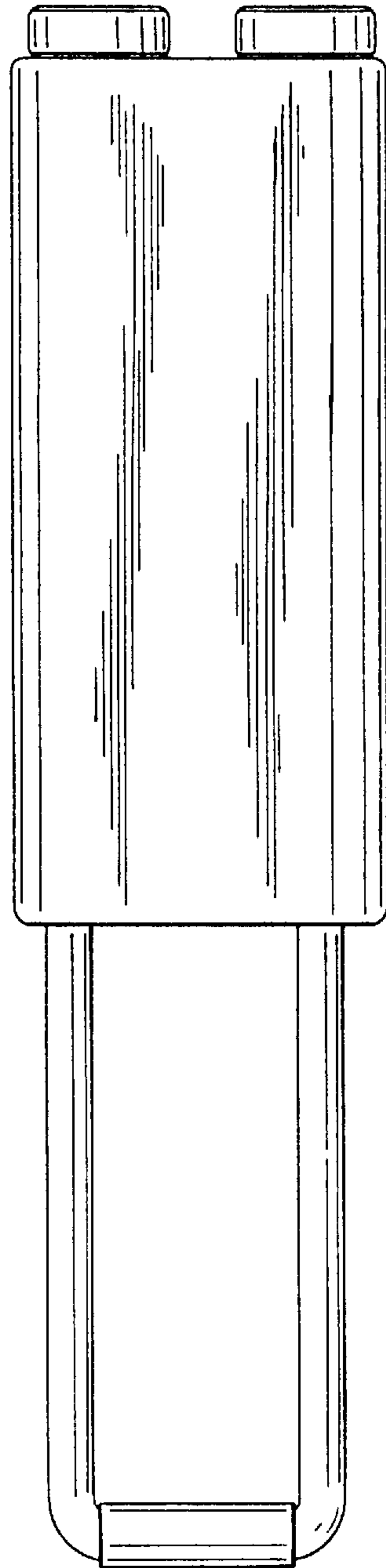

FIG. 8

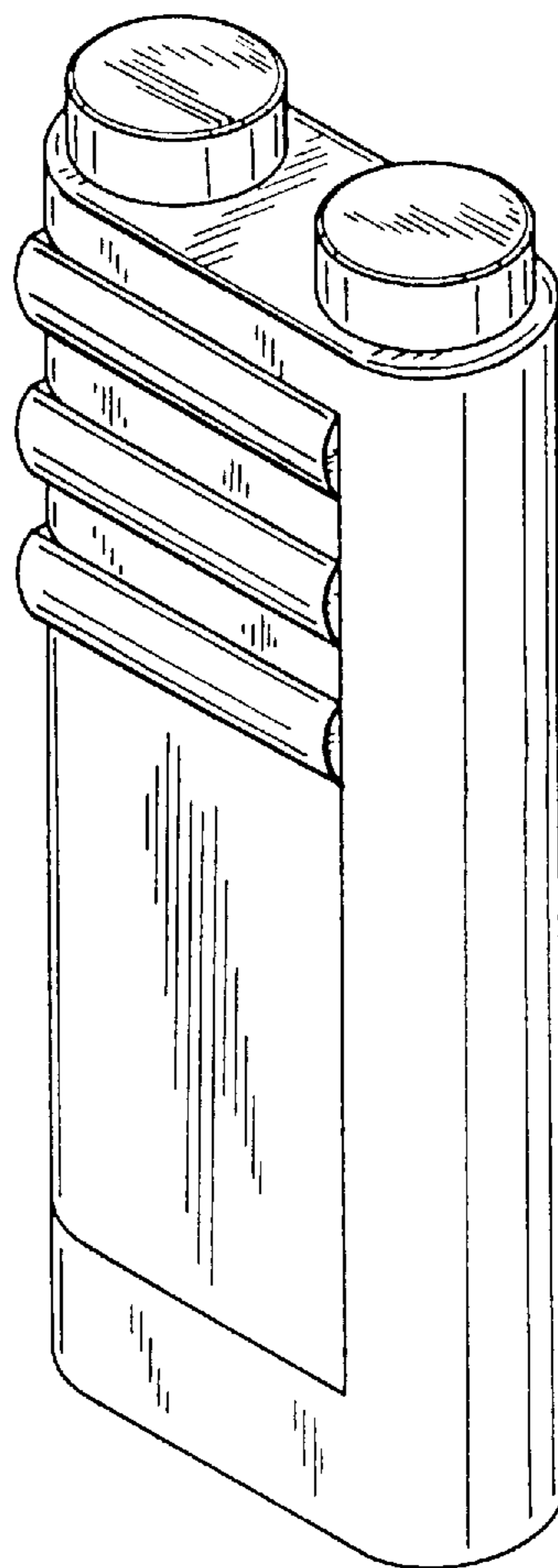

FIG. 9

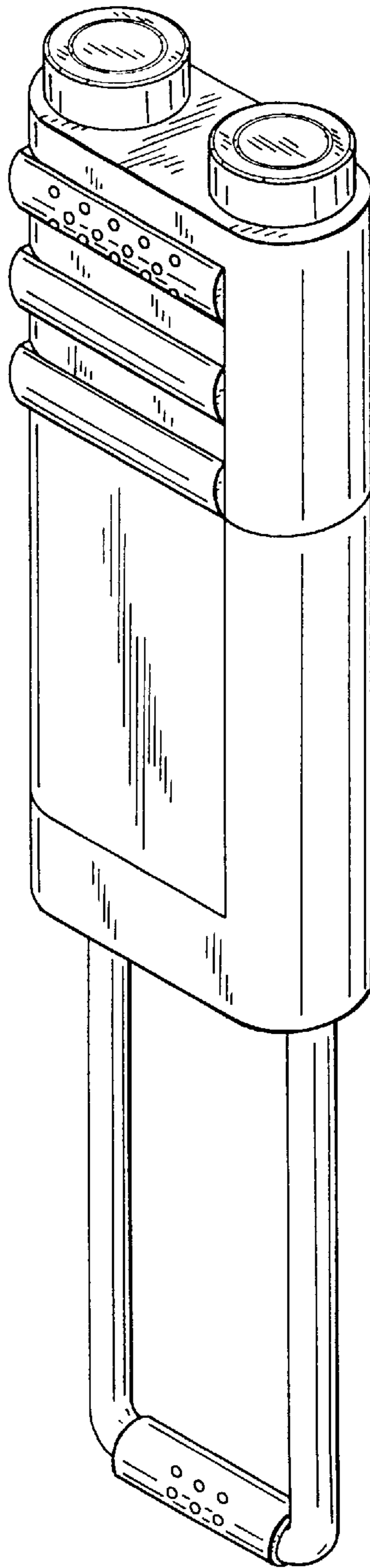

FIG. 10

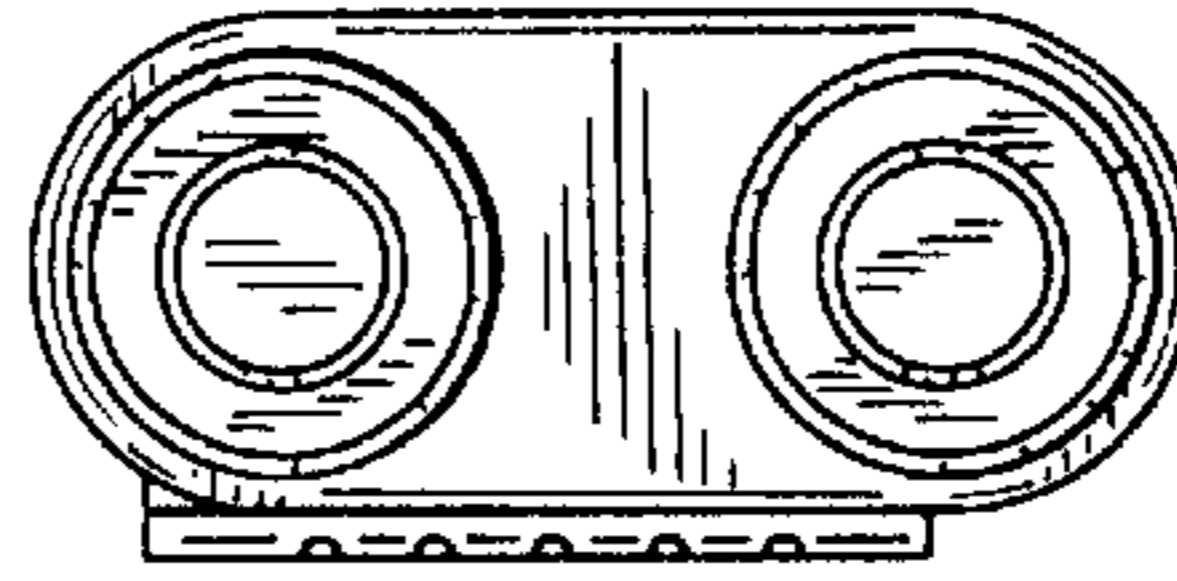

FIG. 11

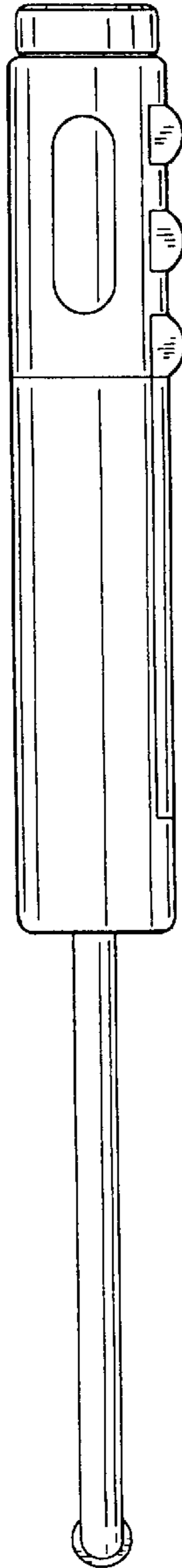

FIG. 12

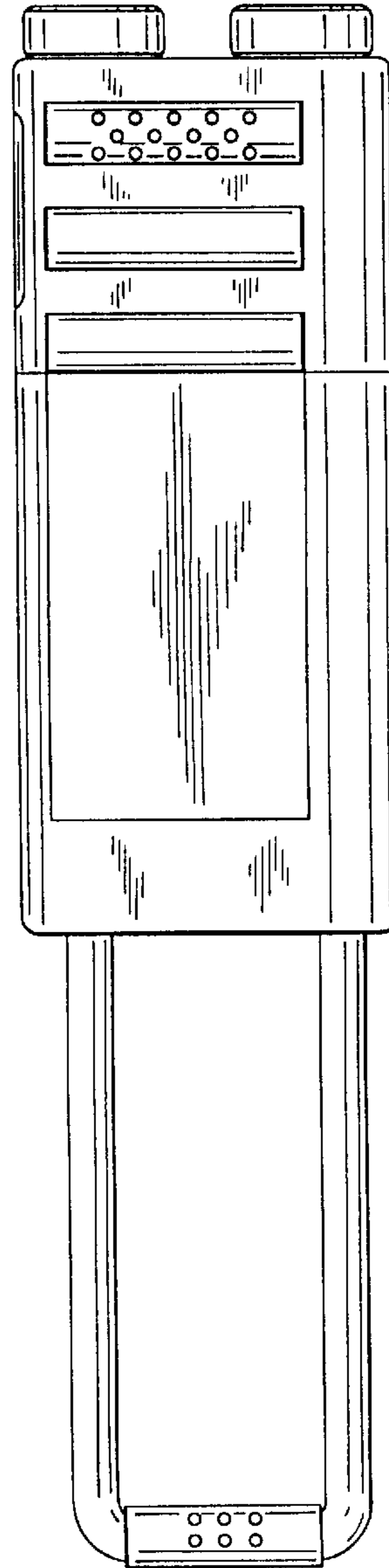

FIG. 13

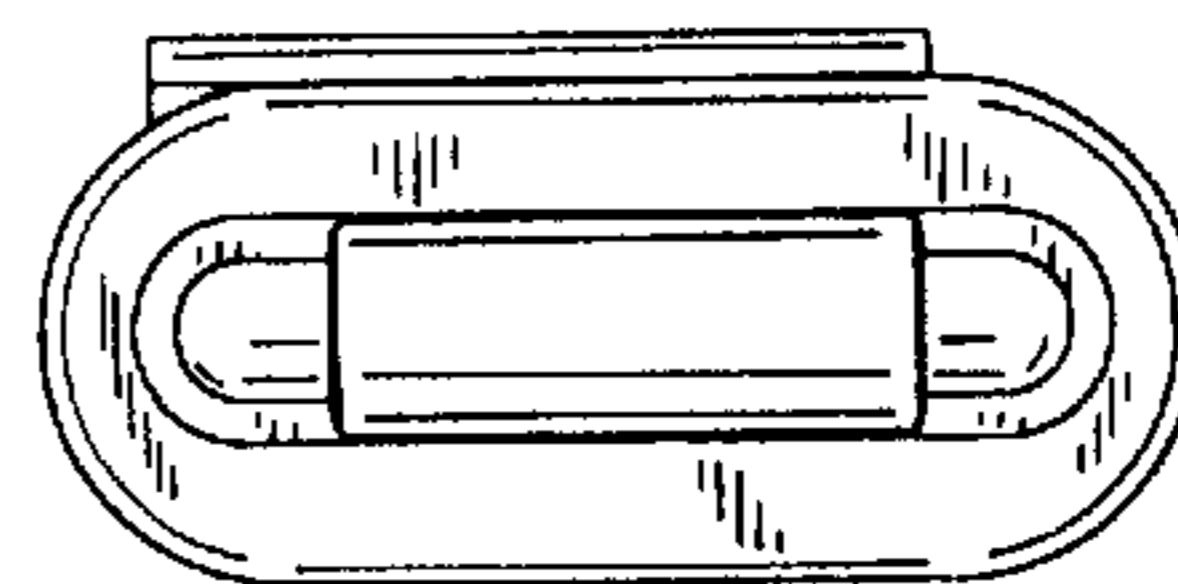

FIG. 14

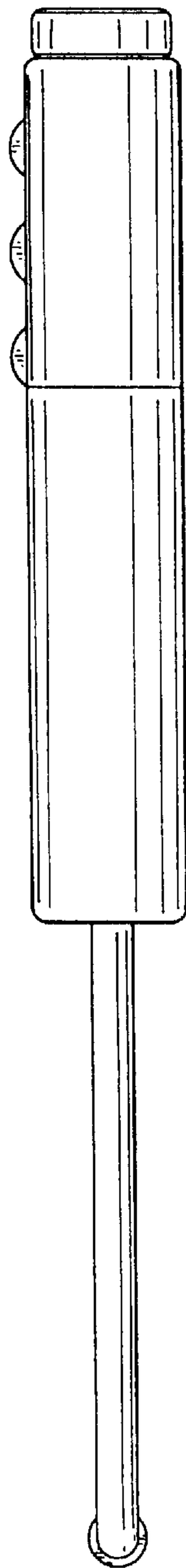

FIG. 15

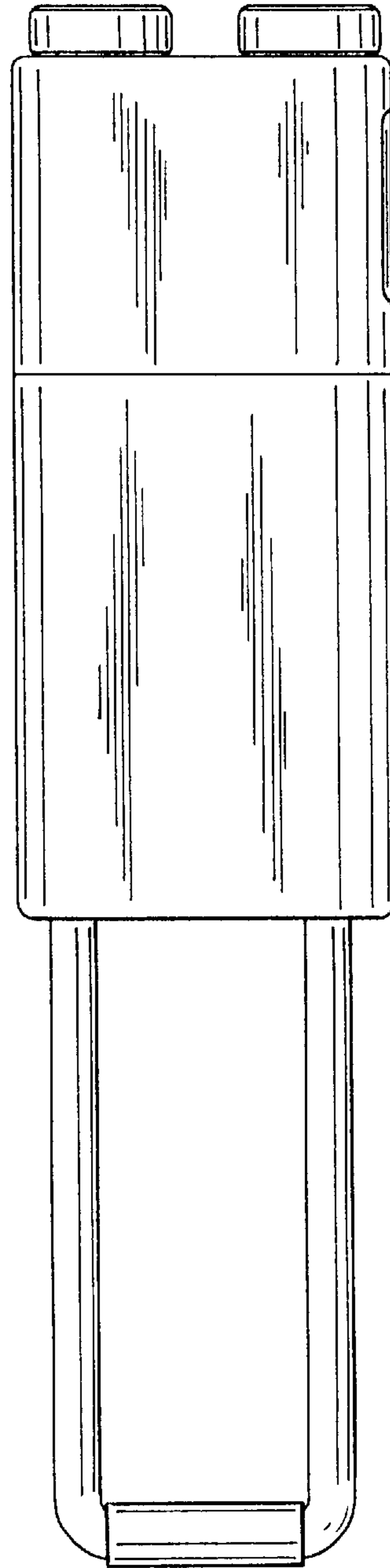

FIG. 16

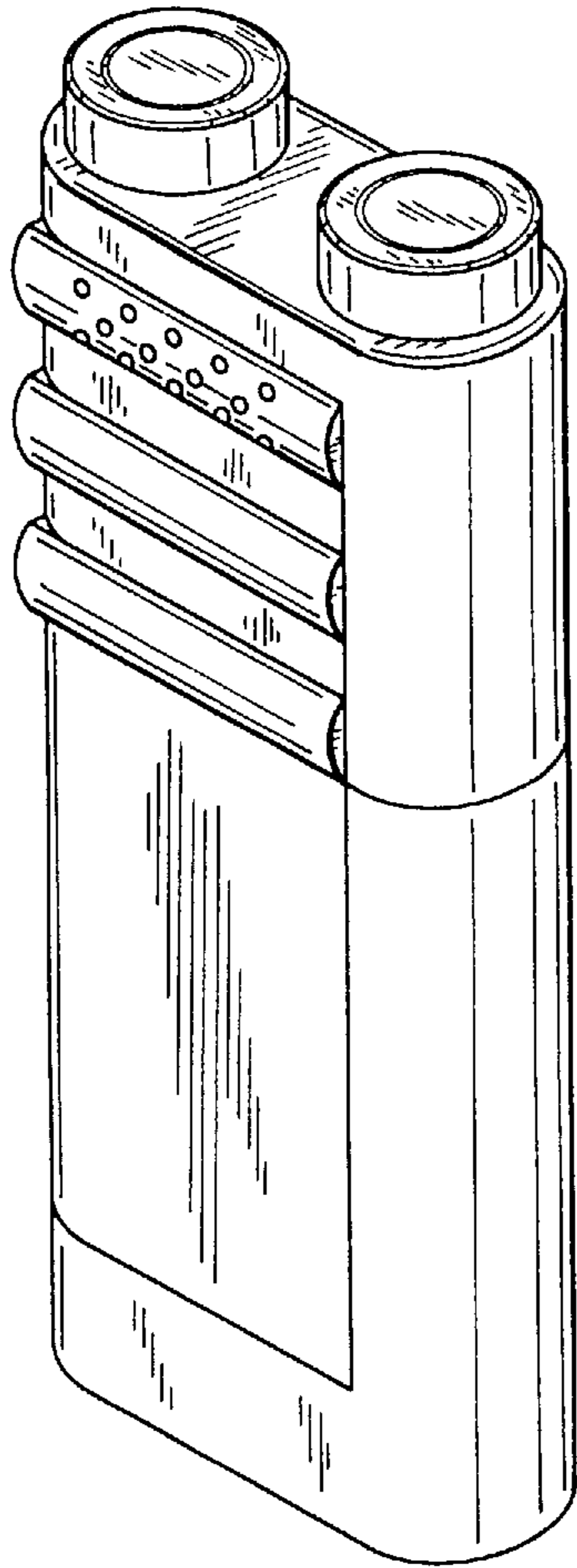

FIG. 17

