



US00D407345S

**United States Patent** [19]  
**Clinton et al.**

[11] **Patent Number: Des. 407,345**  
[45] **Date of Patent: \*\*Mar. 30, 1999**

[54] **COMBINED FIGURINE AND DISPLAY PACKAGE**

D. 308,183 5/1990 Heap ..... D11/158  
D. 330,853 11/1992 Koytuk ..... D9/337  
D. 335,255 5/1993 Carrillo ..... D9/337

[75] Inventors: **Gary A. Clinton; Michael S. Fahrion,**  
both of Norman; **Clark A. Brown,**  
Oklahoma City, all of Okla.

*Primary Examiner*—Dominic Simone  
*Attorney, Agent, or Firm*—McAfee & Taft

[73] Assignee: **United Design Corporation,** Noble,  
Okla.

[57] **CLAIM**

[\*\*] Term: **14 Years**

The ornamental design for a combined figurine and display package, as shown and described.

[21] Appl. No.: **80,554**

**DESCRIPTION**

[22] Filed: **Dec. 3, 1997**

FIG. 1 is a front perspective view of a combined figurine and display package showing our new design;  
FIG. 2 is a right side elevational view thereof;  
FIG. 3 is a left side elevational view thereof;  
FIG. 4 is a front elevational view thereof;  
FIG. 5 is a rear elevational view thereof;  
FIG. 6 is a top plan view thereof; and,  
FIG. 7 is a bottom plan view thereof.

[51] **LOC (6) Cl.** ..... **11-02**

[52] **U.S. Cl.** ..... **D11/158; D9/337; D9/431**

[58] **Field of Search** ..... D11/131, 157,  
D11/158, 117; D9/337, 431; 229/103.2,  
103.3, 108

[56] **References Cited**

**U.S. PATENT DOCUMENTS**

D. 279,649 7/1985 DeMay ..... D9/337

**1 Claim, 3 Drawing Sheets**

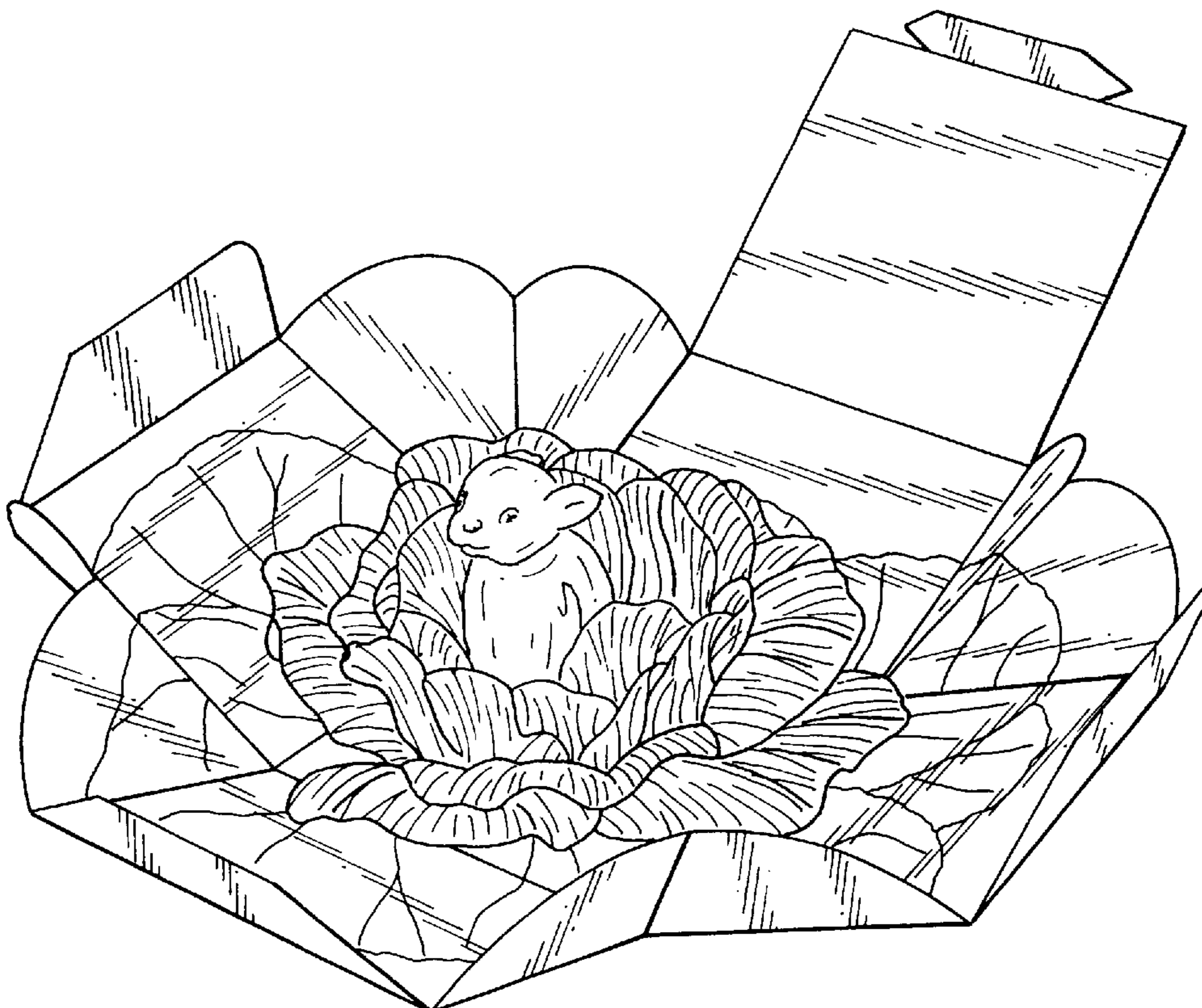

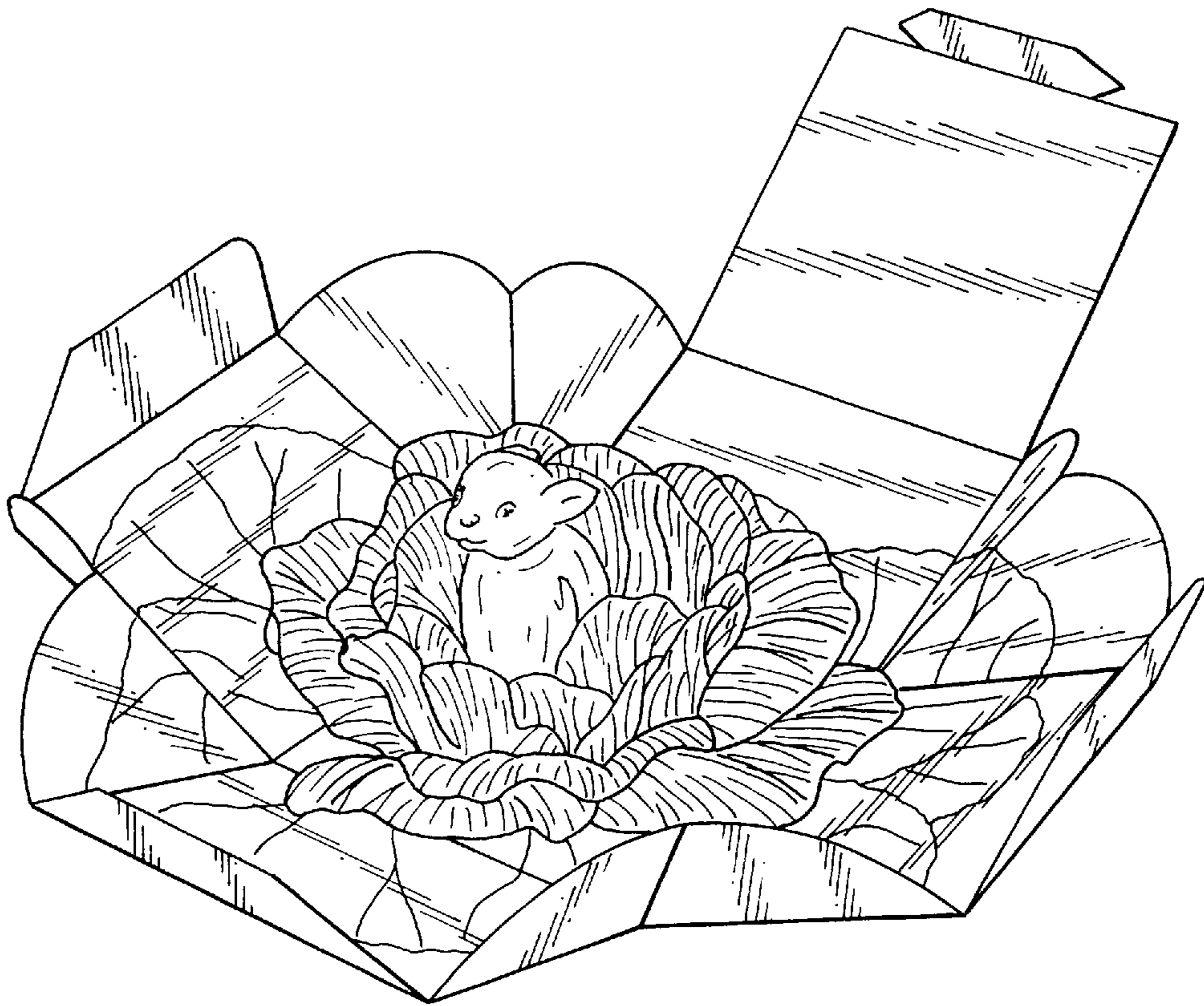

FIG. 1

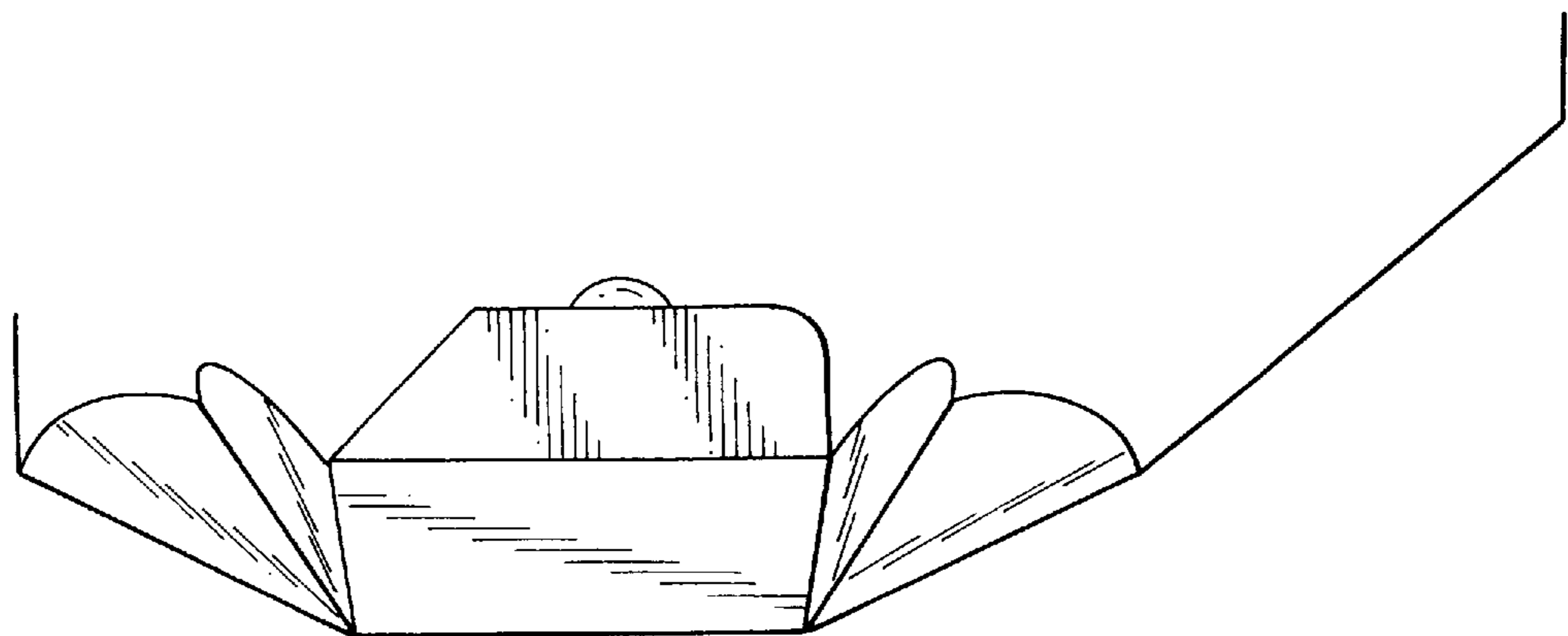

FIG. 2

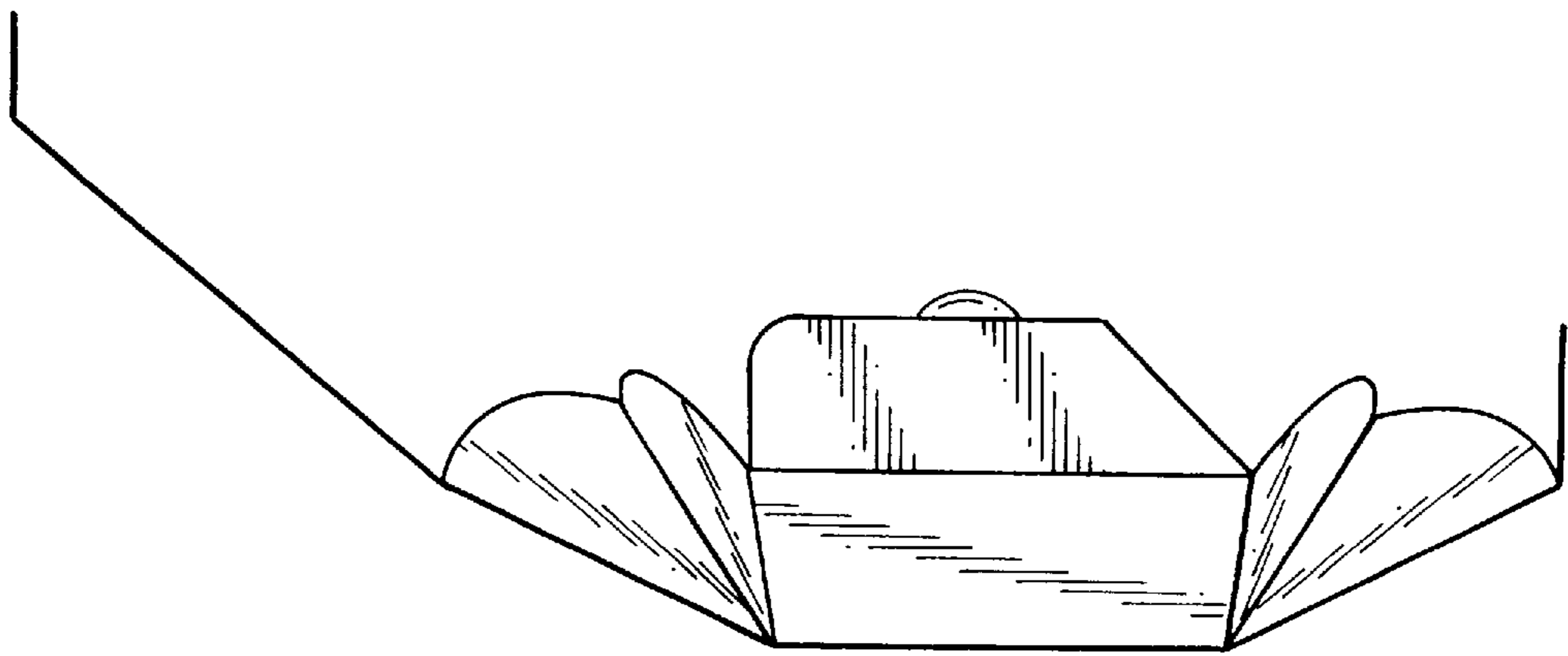

FIG. 3

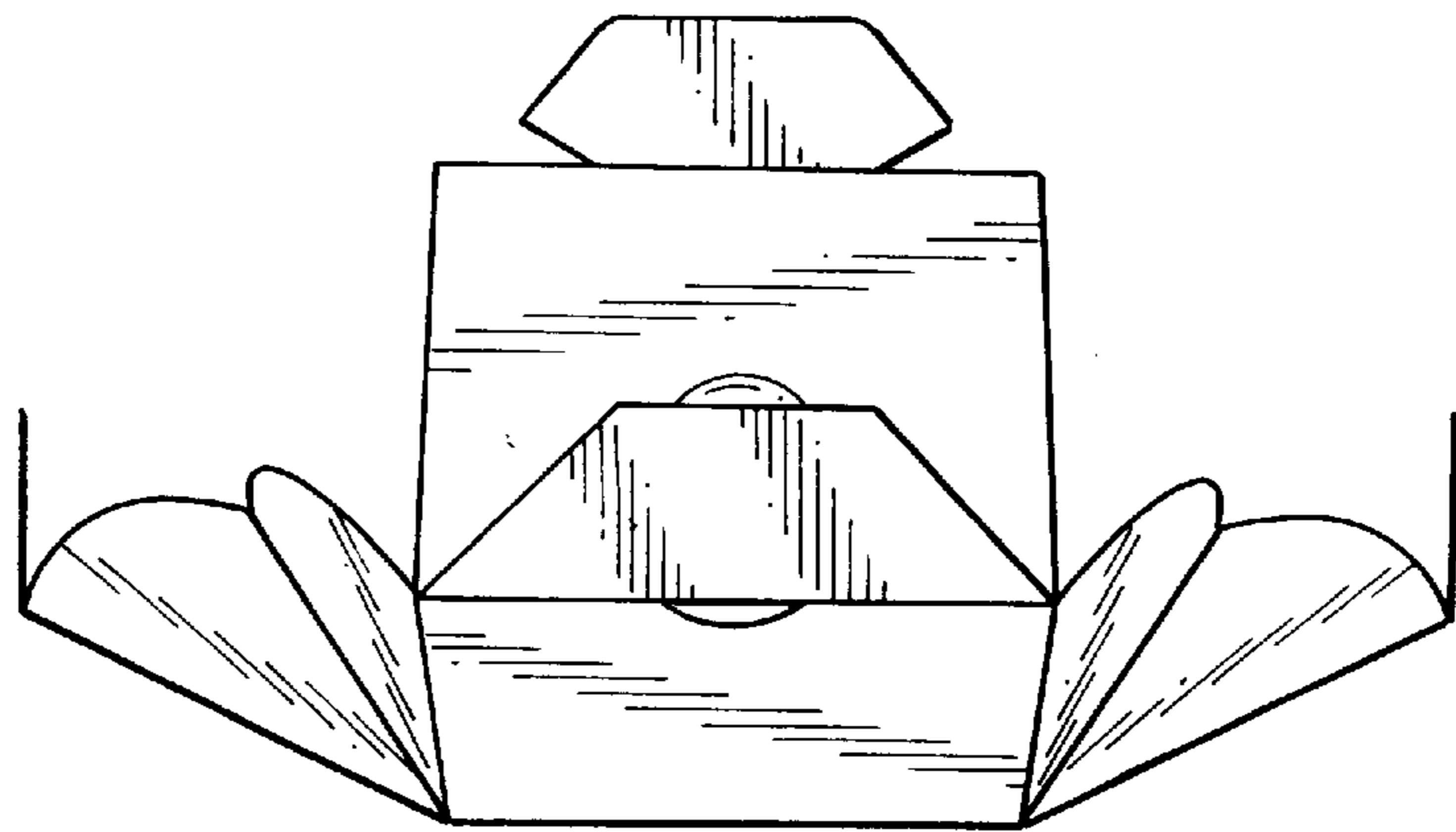

FIG. 4

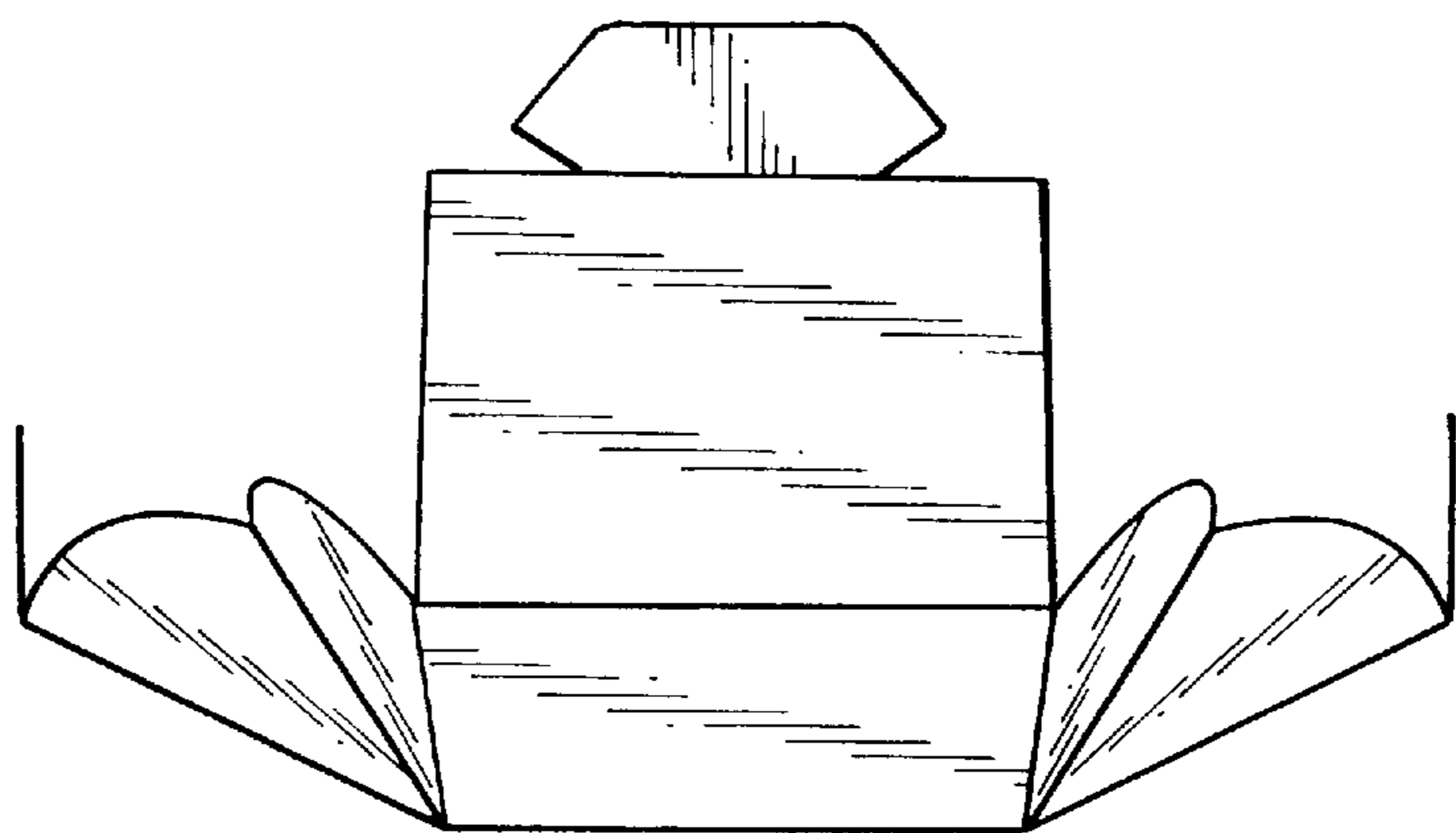

FIG. 5

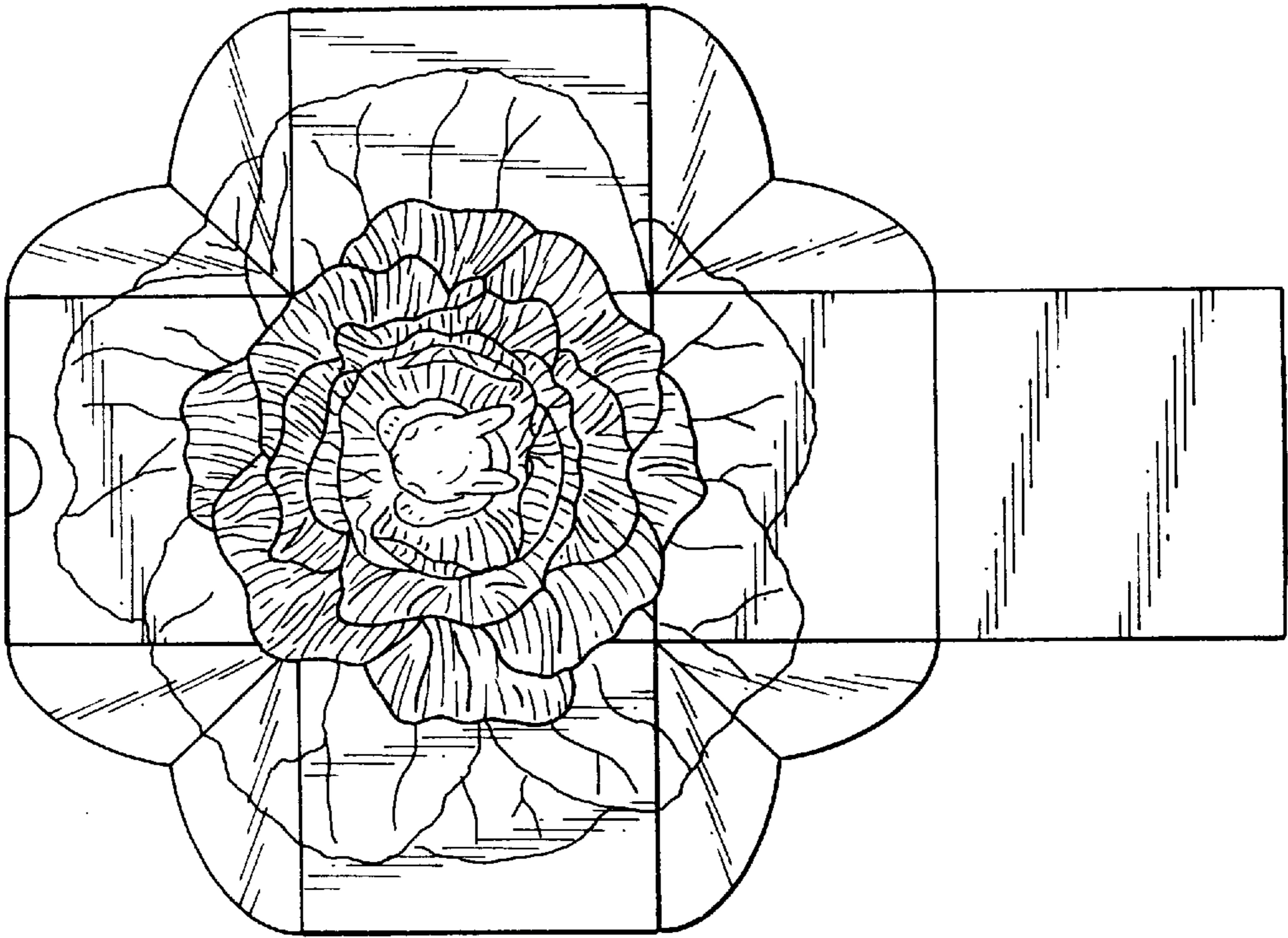

FIG. 6

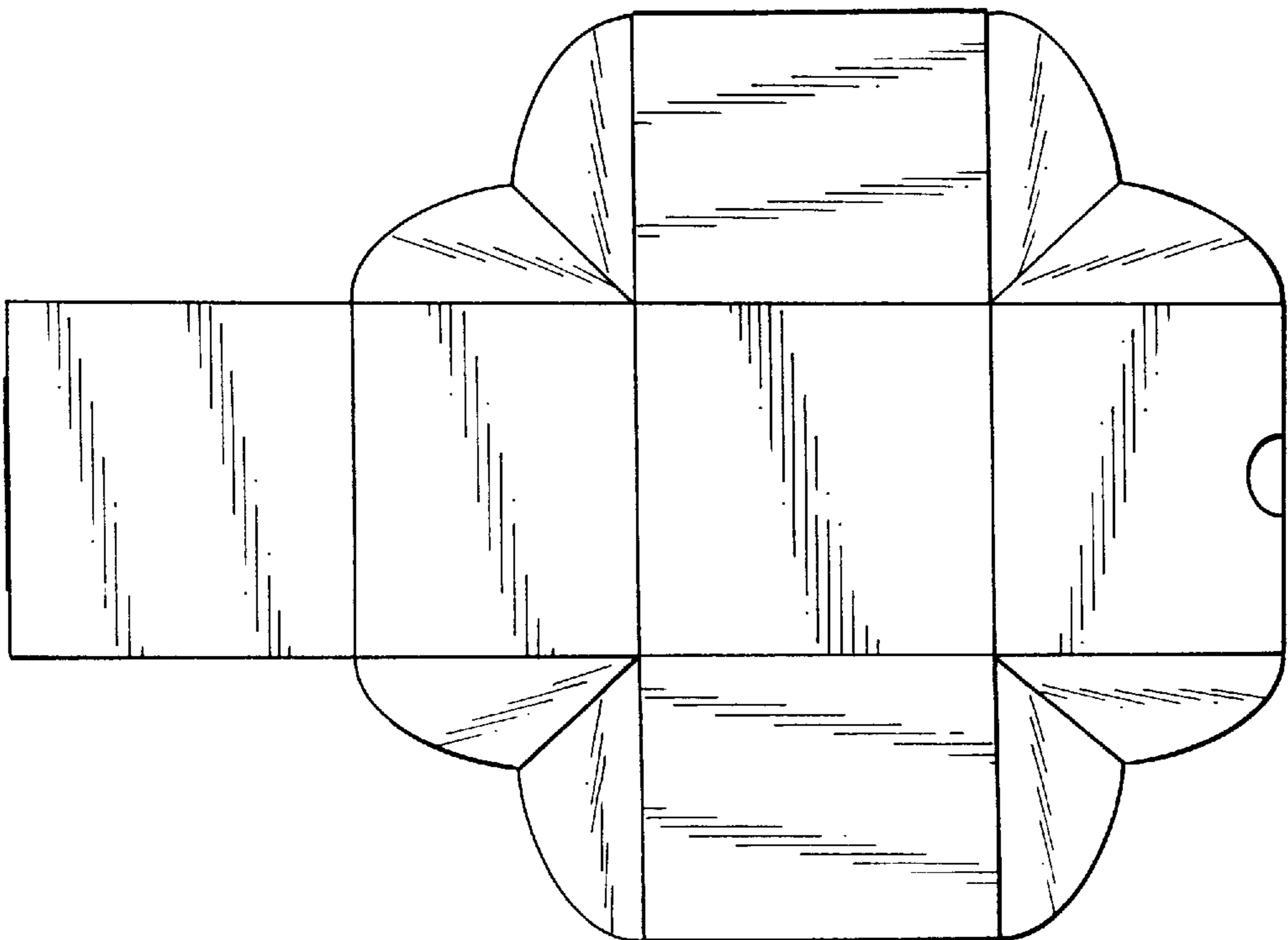

FIG. 7