



US00D407327S

United States Patent [19]

[11] Patent Number: Des. 407,327

Wada et al.

[45] Date of Patent: **Mar. 30, 1999

[54] WATCHCASE

[75] Inventors: Takeshi Wada; Juhei Ozawa, both of Chiba, Japan

[73] Assignee: Seiko Instruments Inc., Japan

[**] Term: 14 Years

[21] Appl. No.: 80,402

[22] Filed: Dec. 8, 1997

[30] Foreign Application Priority Data

Jun. 9, 1997	[JP]	Japan	9-57262
Jun. 9, 1997	[JP]	Japan	9-57263
Jun. 9, 1997	[JP]	Japan	9-57264
Jun. 9, 1997	[JP]	Japan	9-57265
Jun. 9, 1997	[JP]	Japan	9-57266
Jun. 9, 1997	[JP]	Japan	9-57267
Jun. 9, 1997	[JP]	Japan	9-57268

[51] LOC (6) Cl. 10-02

[52] U.S. Cl. D10/30

[58] Field of Search D10/1-40, 122-132; 368/280-282, 276-277, 285

[56] References Cited

U.S. PATENT DOCUMENTS

D. 229,213	11/1973	Sasaki	D10/38
D. 238,254	12/1975	Sulek	D10/38
D. 238,759	2/1976	Sulek	D10/38
D. 244,086	4/1977	Lawrence	D10/38
D. 244,433	5/1977	Banks	D10/38
D. 245,674	9/1977	Sulek	D10/38
D. 245,898	9/1977	Nilson	D10/38
D. 255,224	6/1980	Sulek	D10/38
D. 297,622	9/1988	Lee	D10/38
D. 386,692	11/1997	Kume	D10/30

OTHER PUBLICATIONS

Jeweler's Circular-Keystone-Mar. 1976-p. 22-Watch at Middle.

Swiss Watch & Jewelry Journal-Mar. 1977 p. 352-Pulsar Watches "5A+B"-at Lower Right.

Primary Examiner-Nelson C. Holtje
Attorney, Agent, or Firm-Adams & Wilks

[57] CLAIM

The ornamental design for a watchcase, as shown and described.

DESCRIPTION

FIG. 1 is a front elevational view of a first variant of a watchcase showing our new design;
 FIG. 2 is a rear elevational view thereof;
 FIG. 3 is a top plan view thereof;
 FIG. 4 is a bottom plan view thereof;
 FIG. 5 is a left elevational view thereof;
 FIG. 6 is a right elevational view thereof;
 FIG. 7 is a vertical cross-sectional view thereof taken along line 7-7 of FIG. 1;
 FIG. 8 is a front elevational view of a second variant thereof;
 FIG. 9 is a rear elevational view thereof;
 FIG. 10 is a top plan view thereof;
 FIG. 11 is a bottom plan view thereof;
 FIG. 12 is a left elevational view thereof;
 FIG. 13 is a right elevational view thereof;
 FIG. 14 is a vertical cross-sectional view thereof taken along line 14-14 of FIG. 8;
 FIG. 15 is a front elevational view of a third variant thereof;
 FIG. 16 is a rear elevational view thereof;
 FIG. 17 is a top plan view thereof;
 FIG. 18 is a bottom plan view thereof;
 FIG. 19 is a left elevational view thereof;
 FIG. 20 is a right elevational view thereof;
 FIG. 21 is a vertical cross-sectional view thereof taken along line 21-21 of FIG. 15;
 FIG. 22 is a front elevational view of a fourth variant thereof;
 FIG. 23 is a rear elevational view thereof;
 FIG. 24 is a top plan view thereof;
 FIG. 25 is a bottom plan view thereof;
 FIG. 26 is a left elevational view thereof;
 FIG. 27 is a right elevational view thereof;
 FIG. 28 is a vertical cross-sectional view thereof taken along line 28-28 of FIG. 22;
 FIG. 29 is a front elevational view of a fifth variant thereof;
 FIG. 30 is a rear elevational view thereof;
 FIG. 31 is a top plan view thereof;
 FIG. 32 is a bottom plan view thereof;
 FIG. 33 is a left elevational view thereof;
 FIG. 34 is a right elevational view thereof;

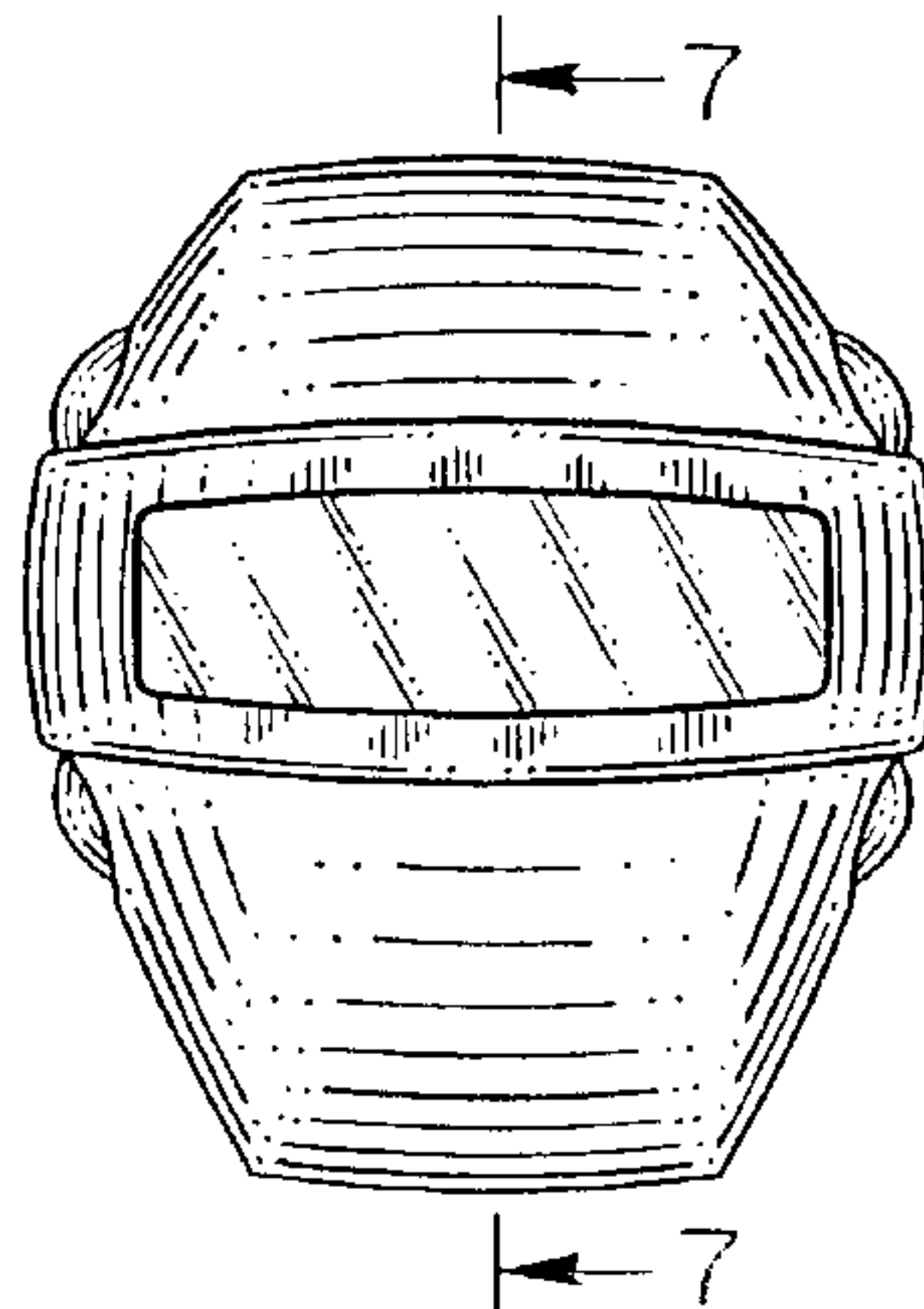

FIG. 35 is a vertical cross-sectional view thereof; taken along line 35—35 of FIG. 29;

FIG. 36 is a front elevational view of a sixth variant thereof;

FIG. 37 is a rear elevational view thereof;

FIG. 38 is a top plan view thereof;

FIG. 39 is a bottom plan view thereof;

FIG. 40 is a left elevational view thereof;

FIG. 41 is a right elevational view thereof;

FIG. 42 is a vertical cross-sectional view thereof taken along line 42—42 of FIG. 36;

FIG. 43 is a front elevational view of a seventh variant thereof;

FIG. 44 is a rear elevational view thereof;

FIG. 45 is a top plan view thereof;

FIG. 46 is a bottom plan view thereof;

FIG. 47 is a left elevational view thereof;

FIG. 48 is a right elevational view thereof; and,

FIG. 49 is a vertical cross-sectional view thereof; taken along line 49—49 of FIG. 43.

1 Claim, 7 Drawing Sheets

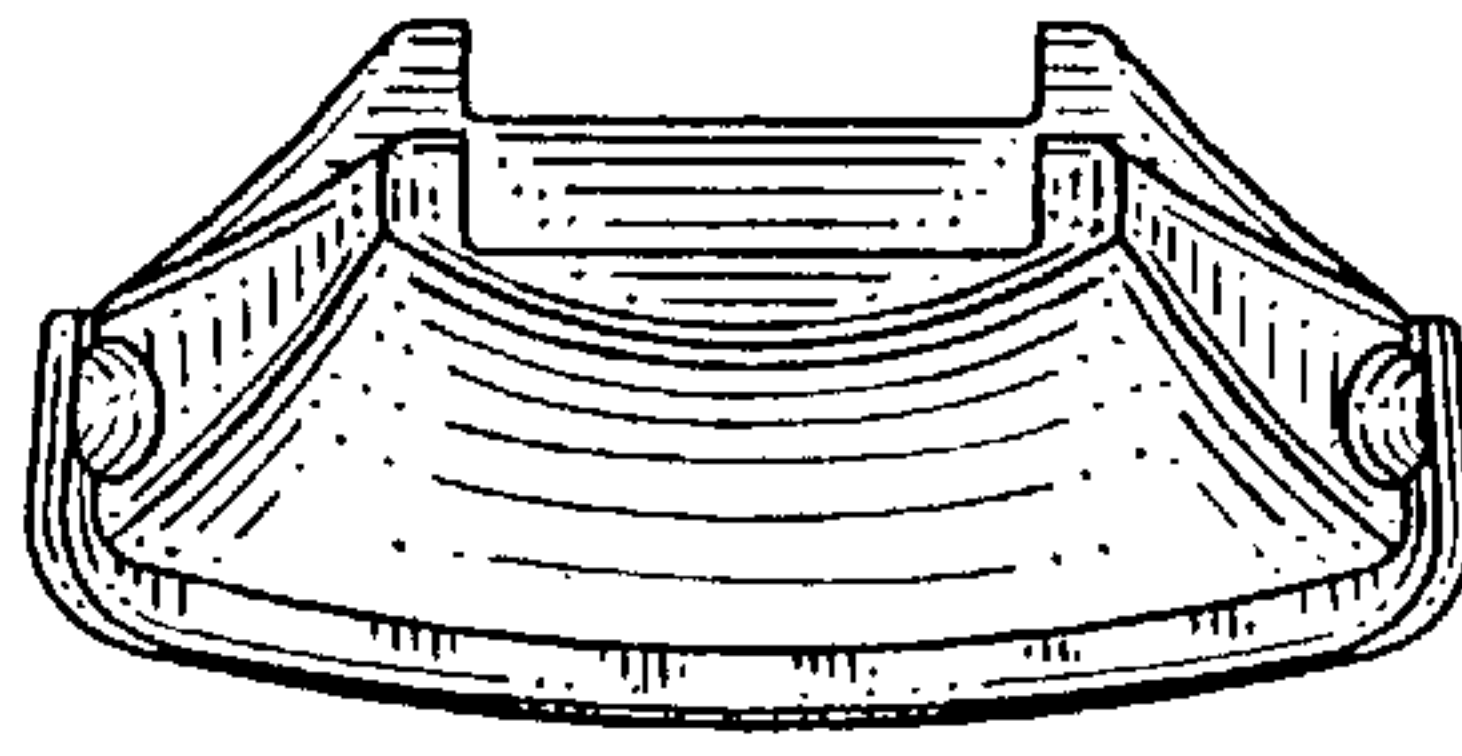

FIG. 3

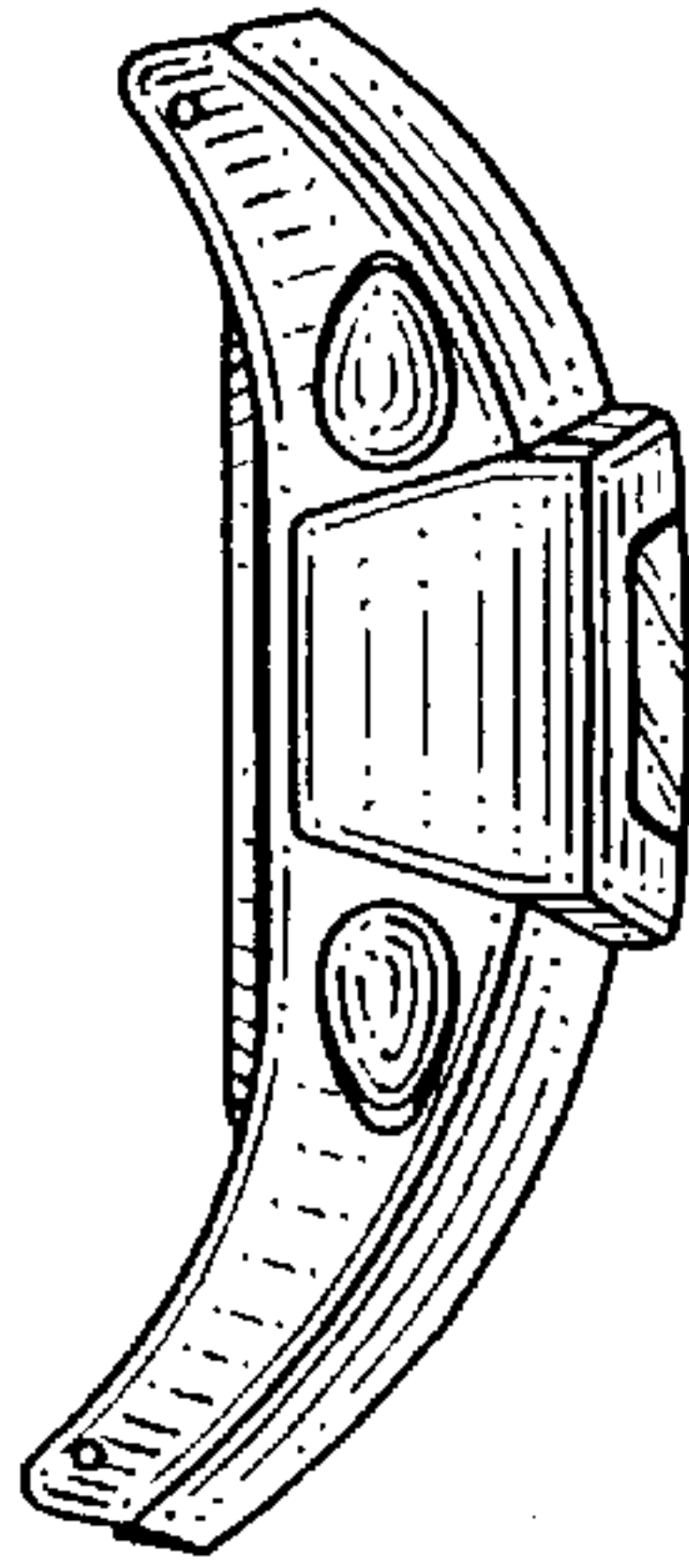

FIG. 5

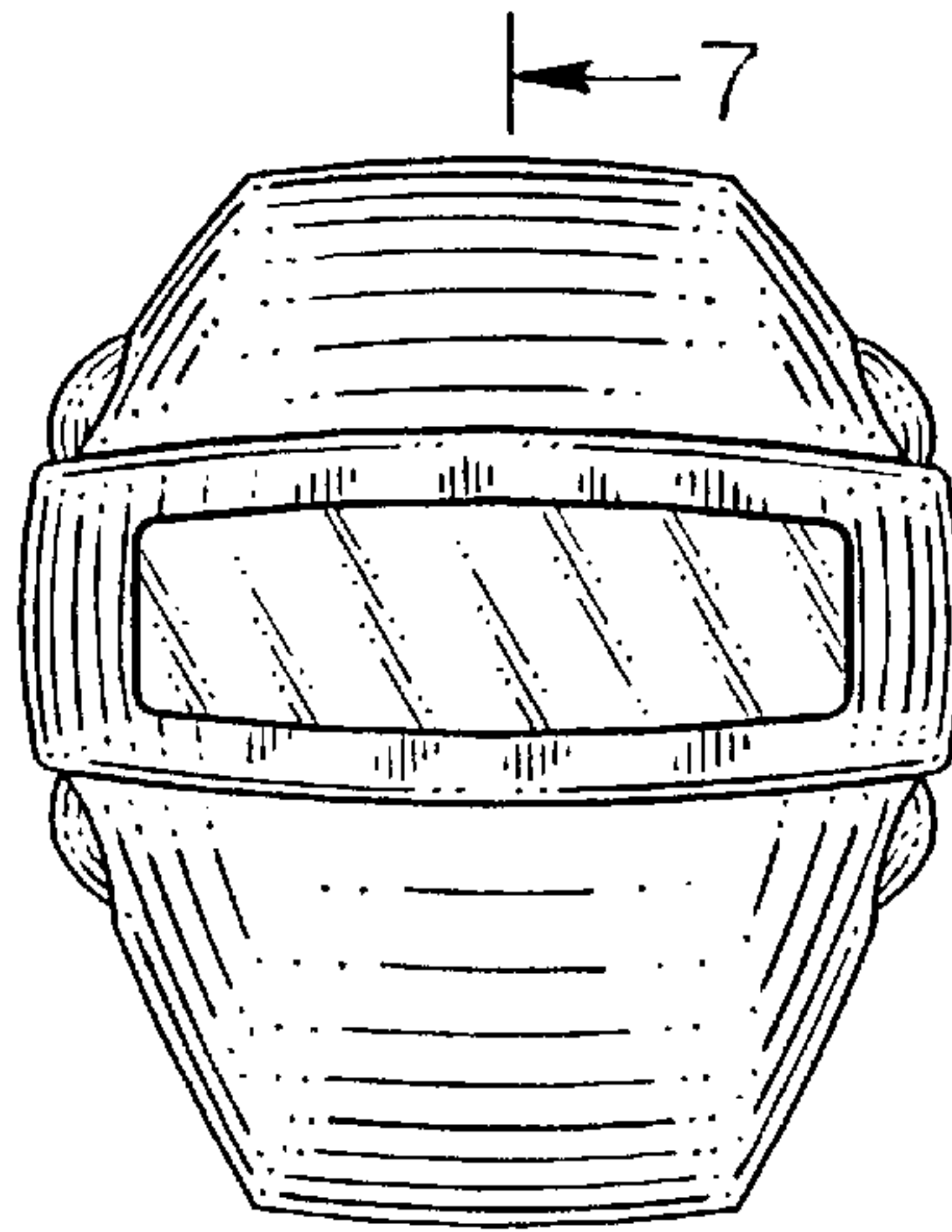

FIG. 1

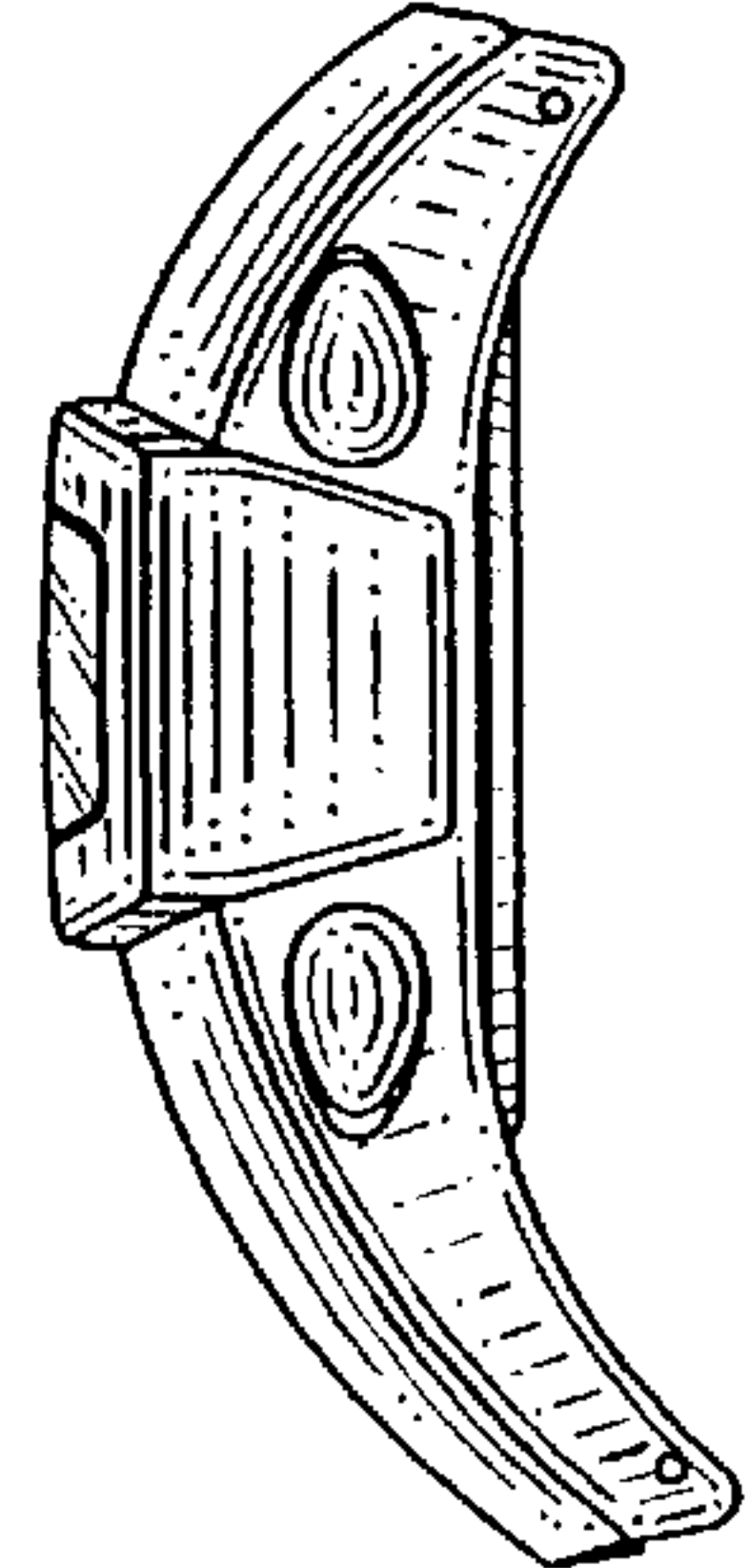

FIG. 6

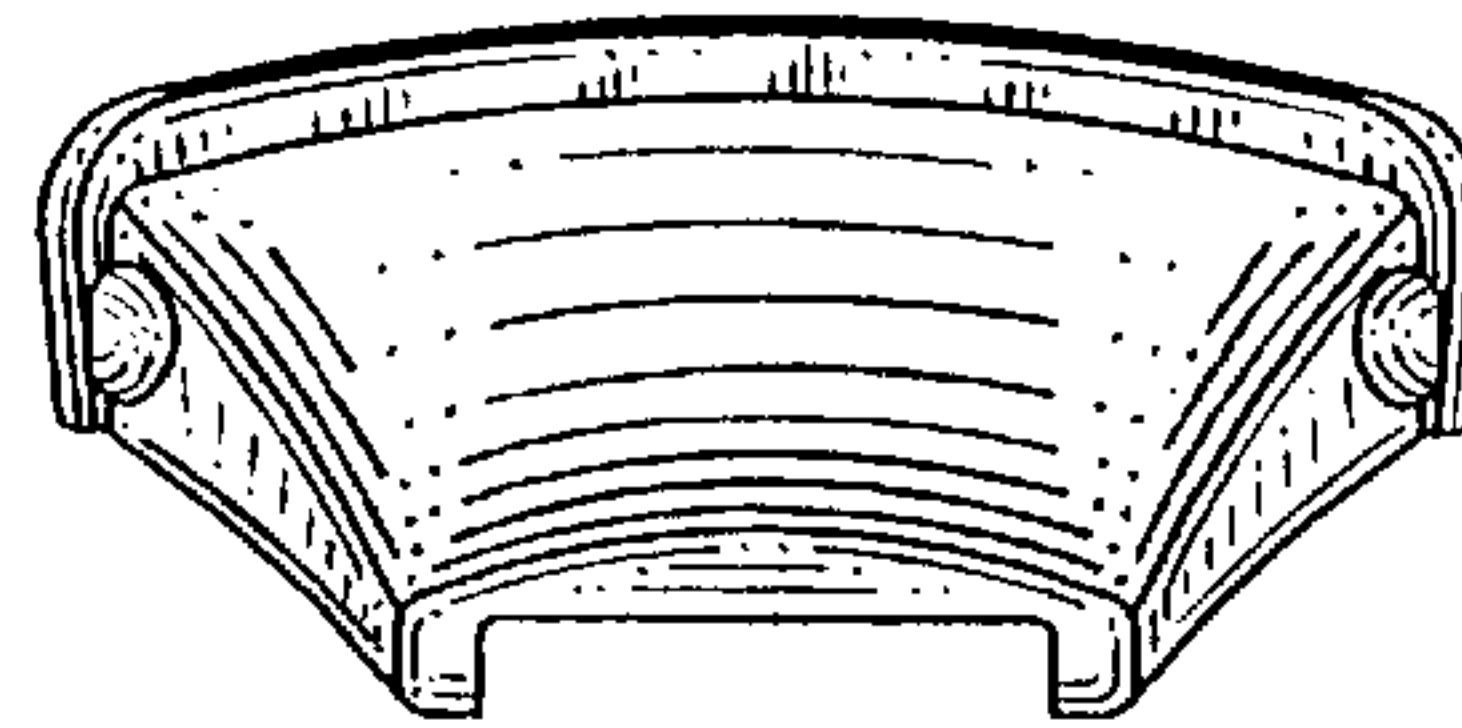

FIG. 4

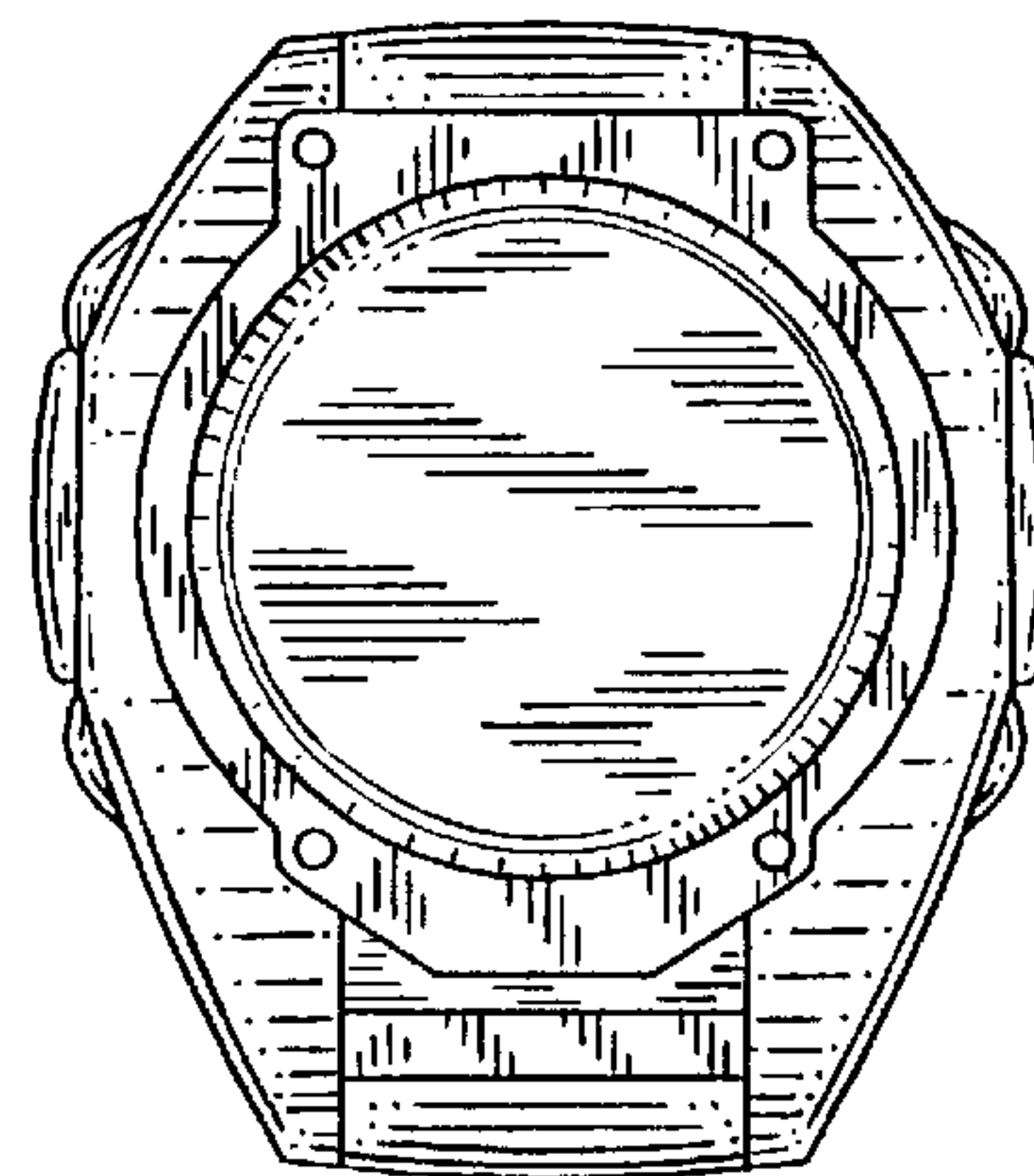

FIG. 2

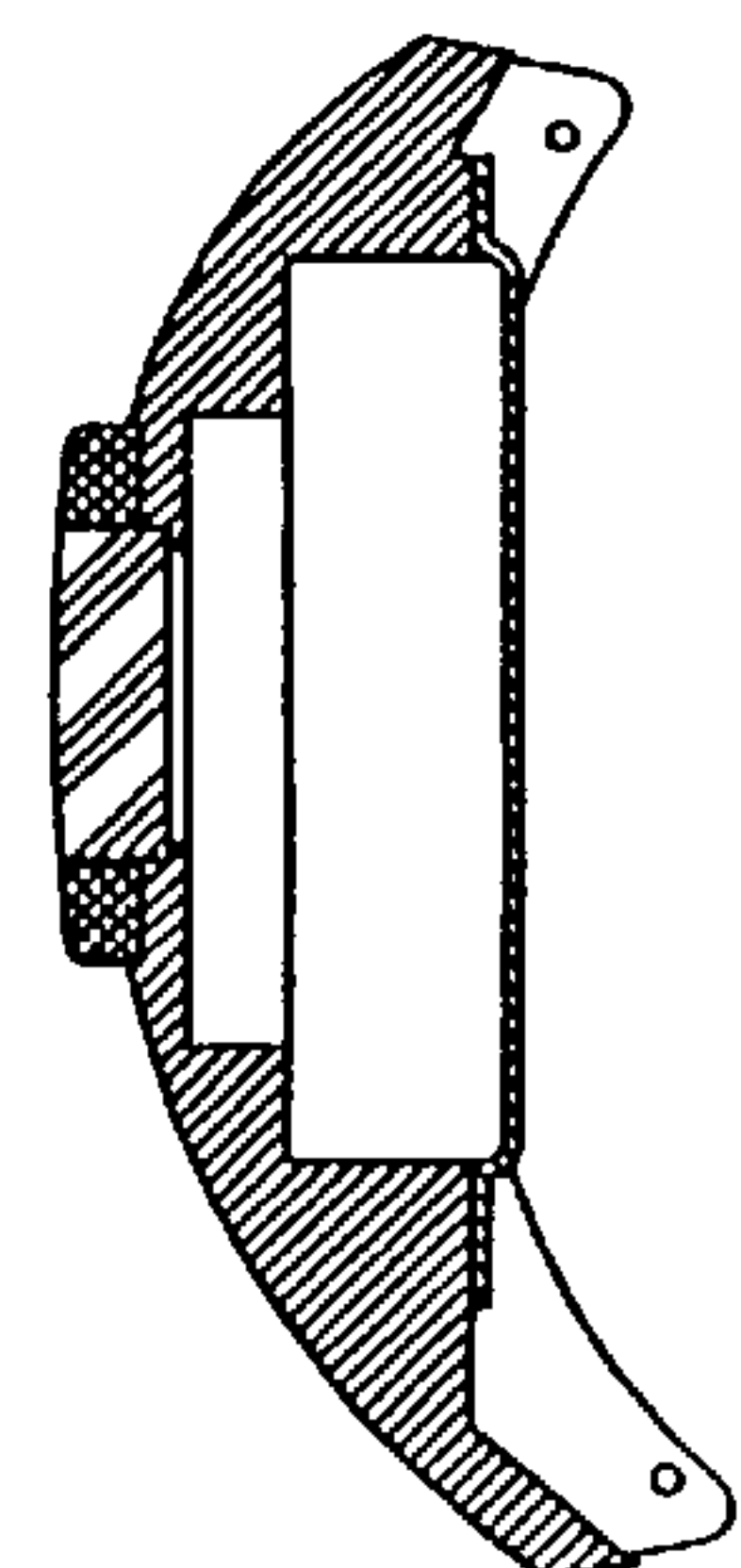

FIG. 7

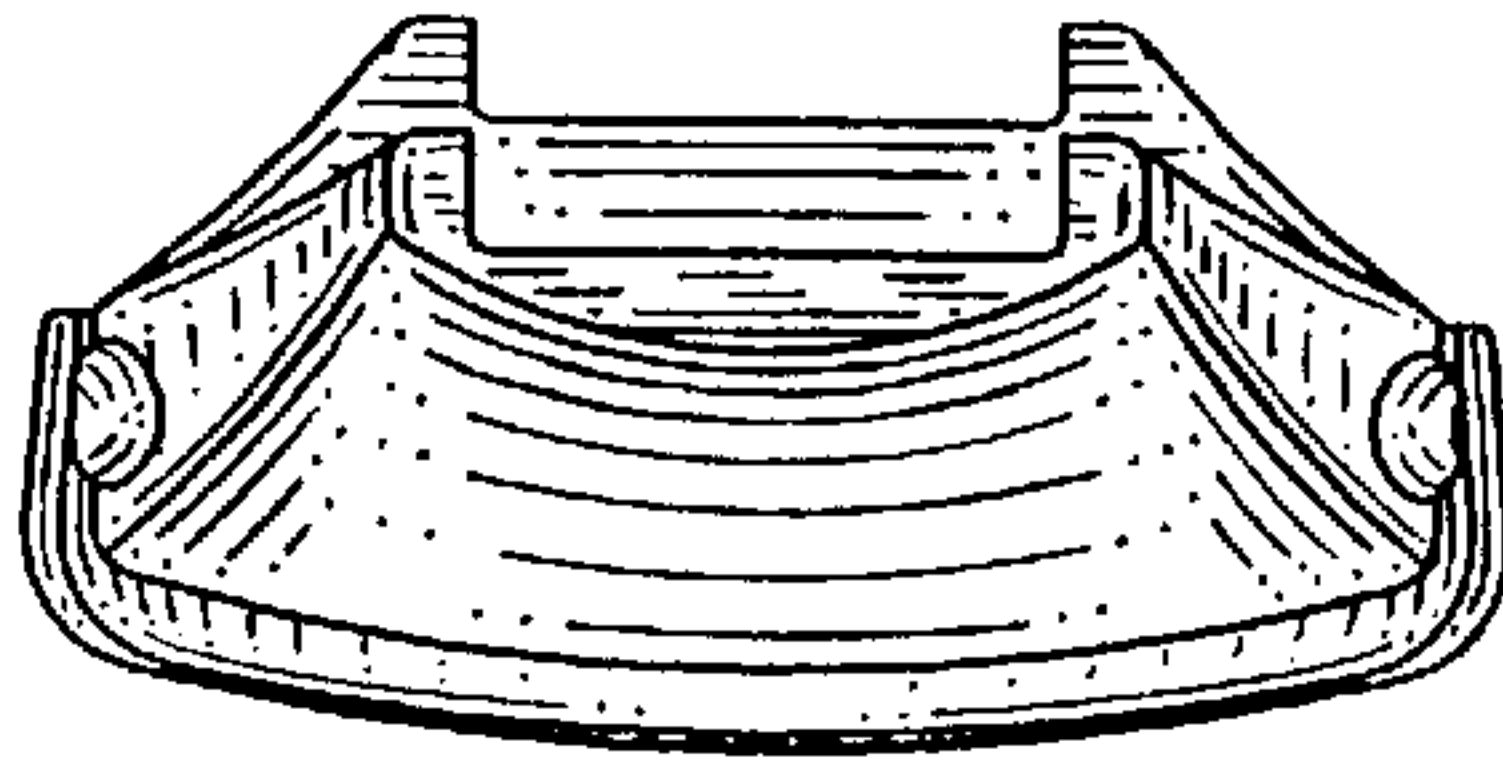

FIG. 10

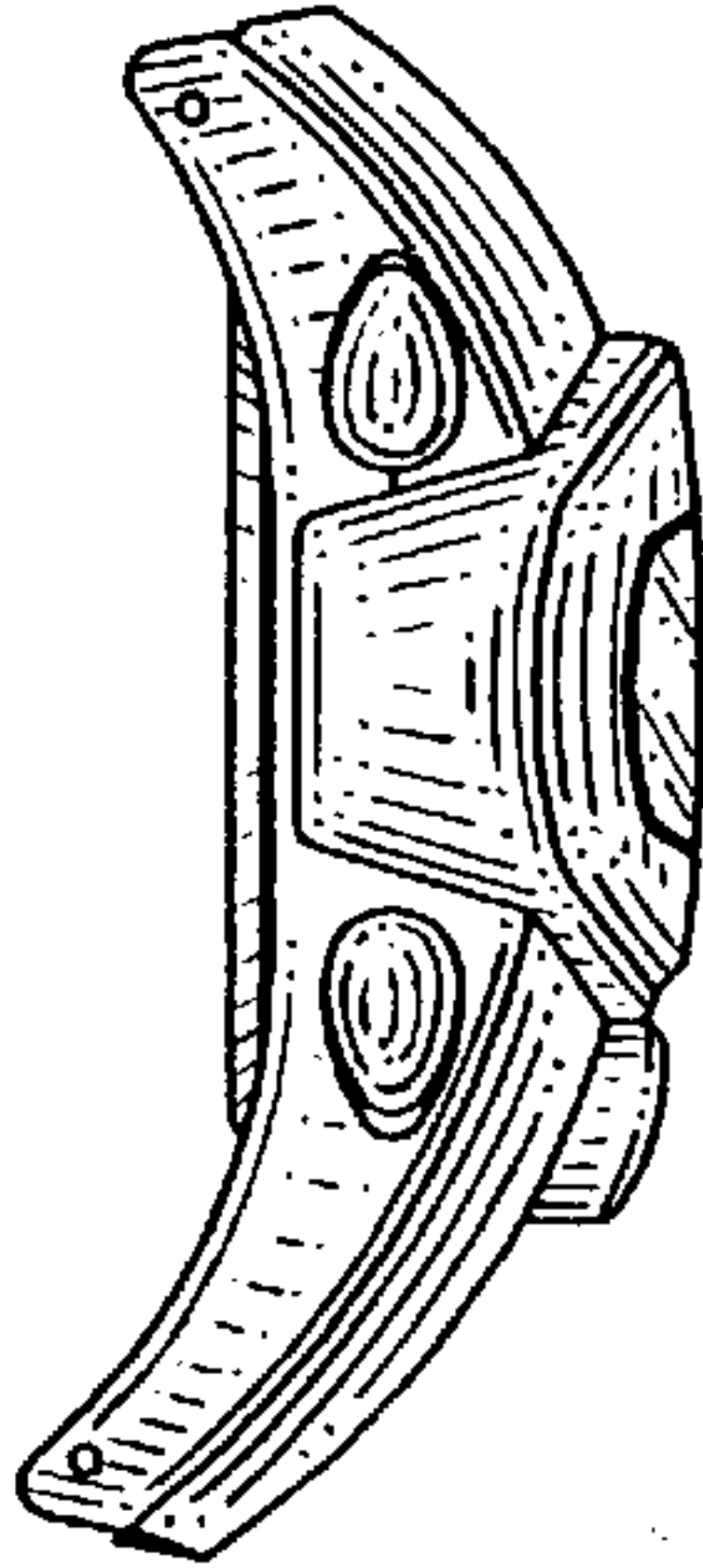

FIG. 12

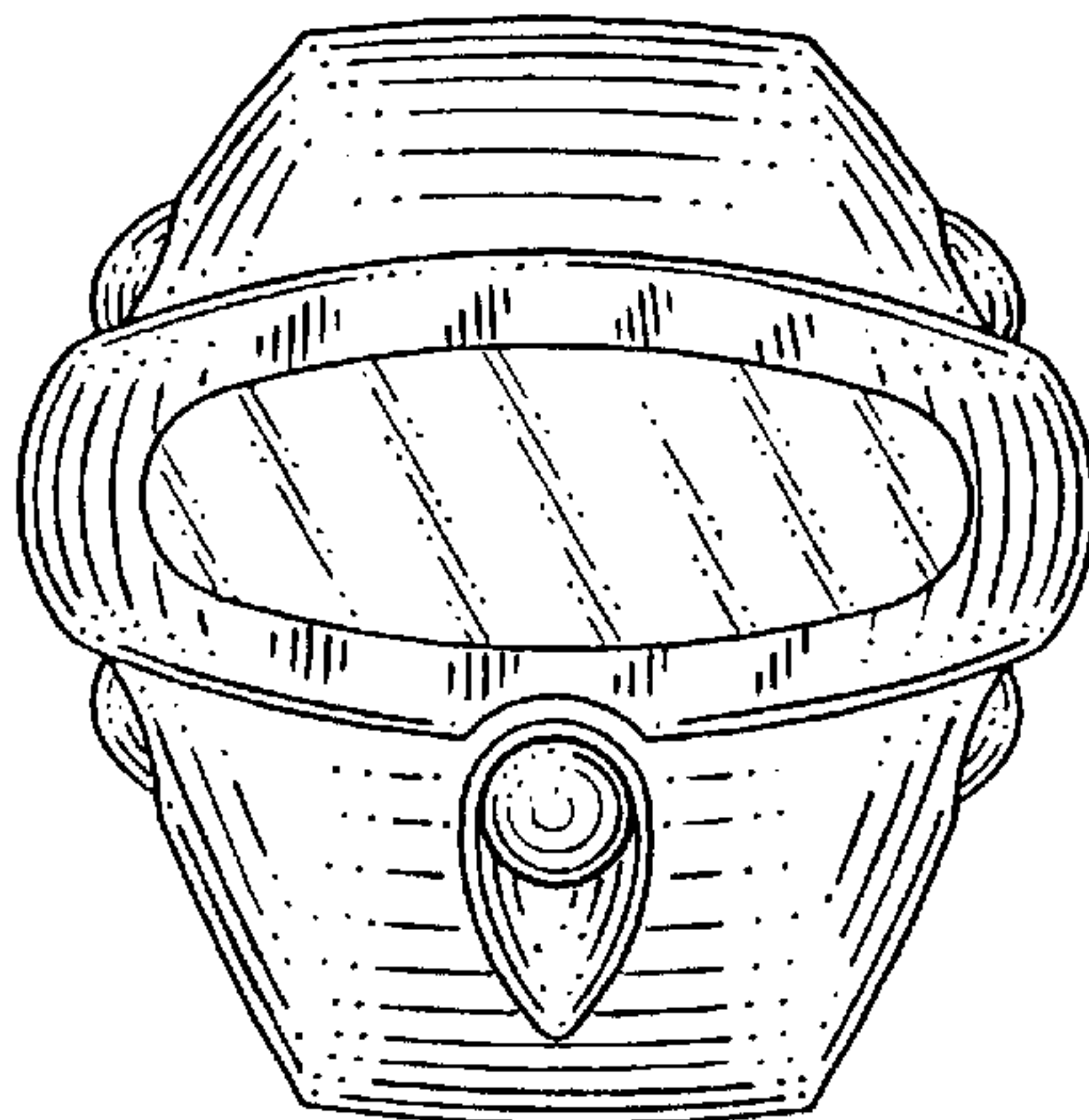

FIG. 8

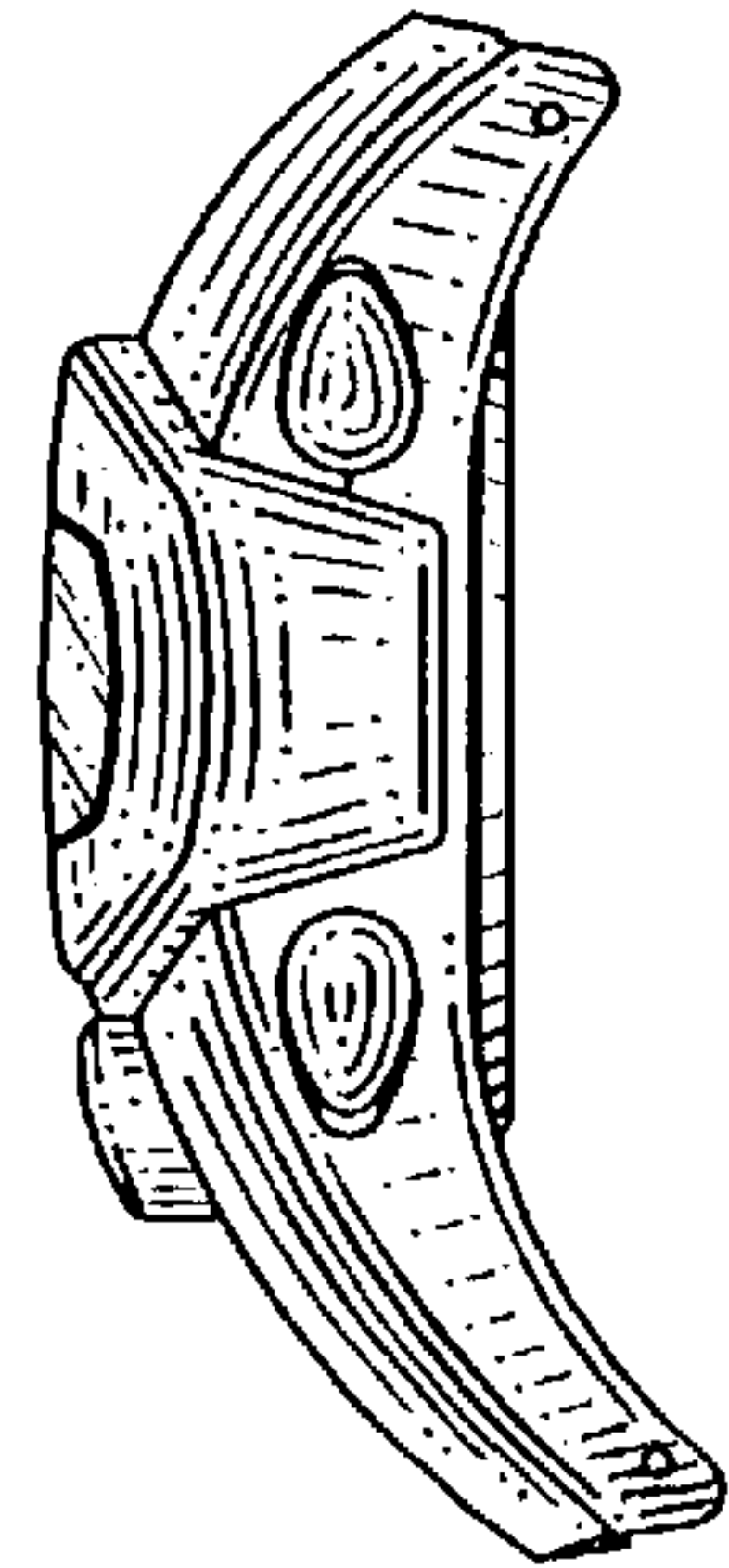

FIG. 13

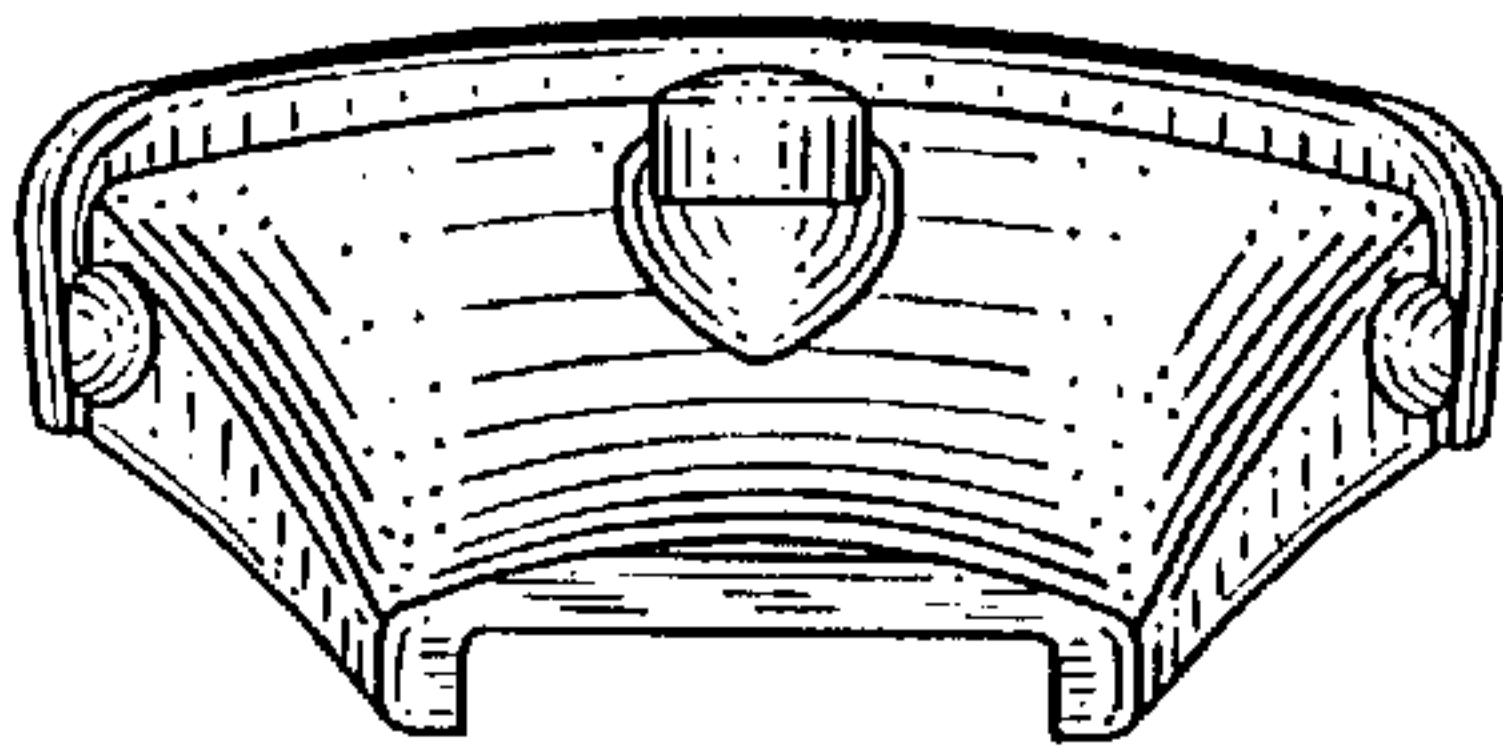

FIG. 11

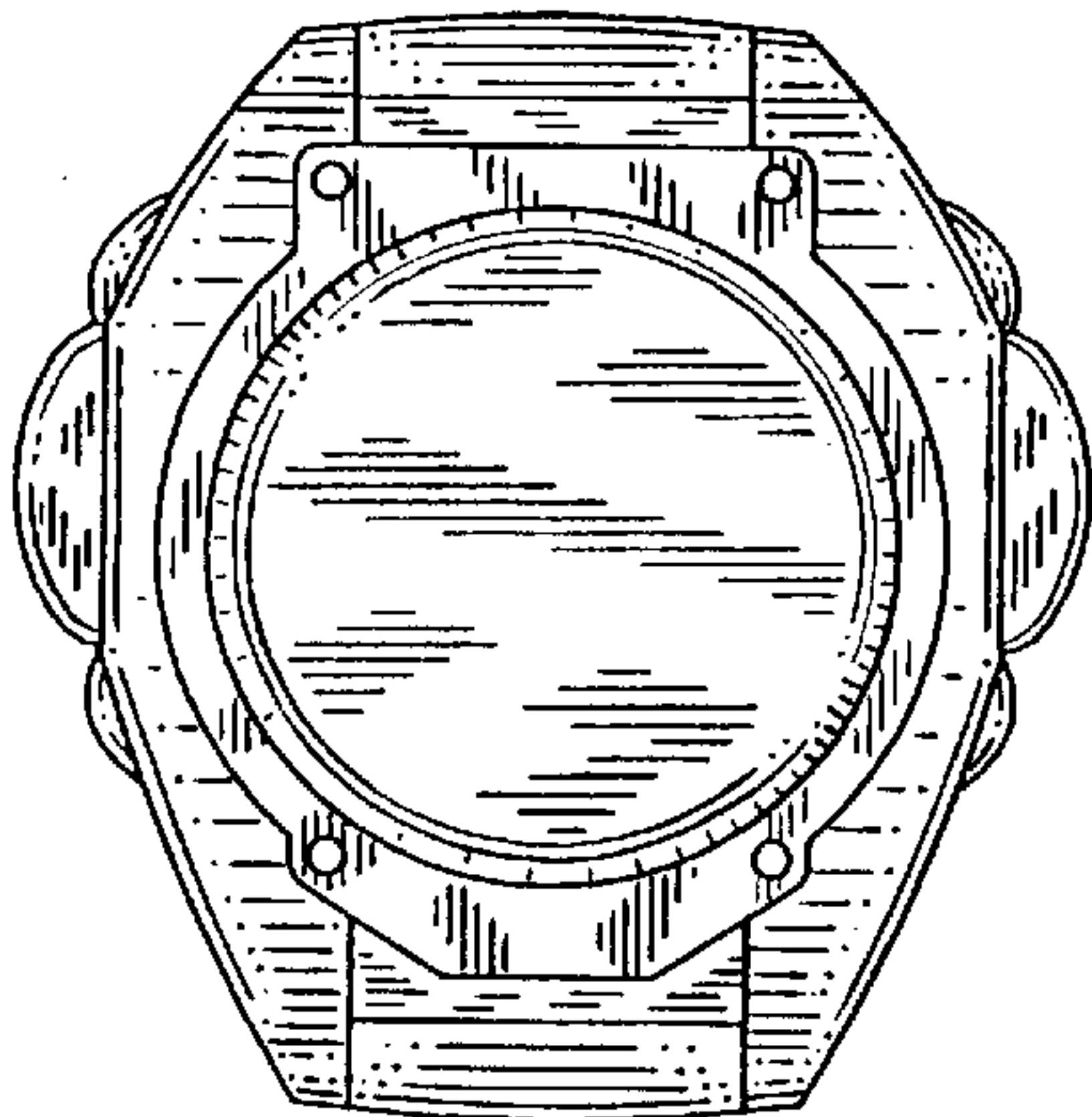

FIG. 9

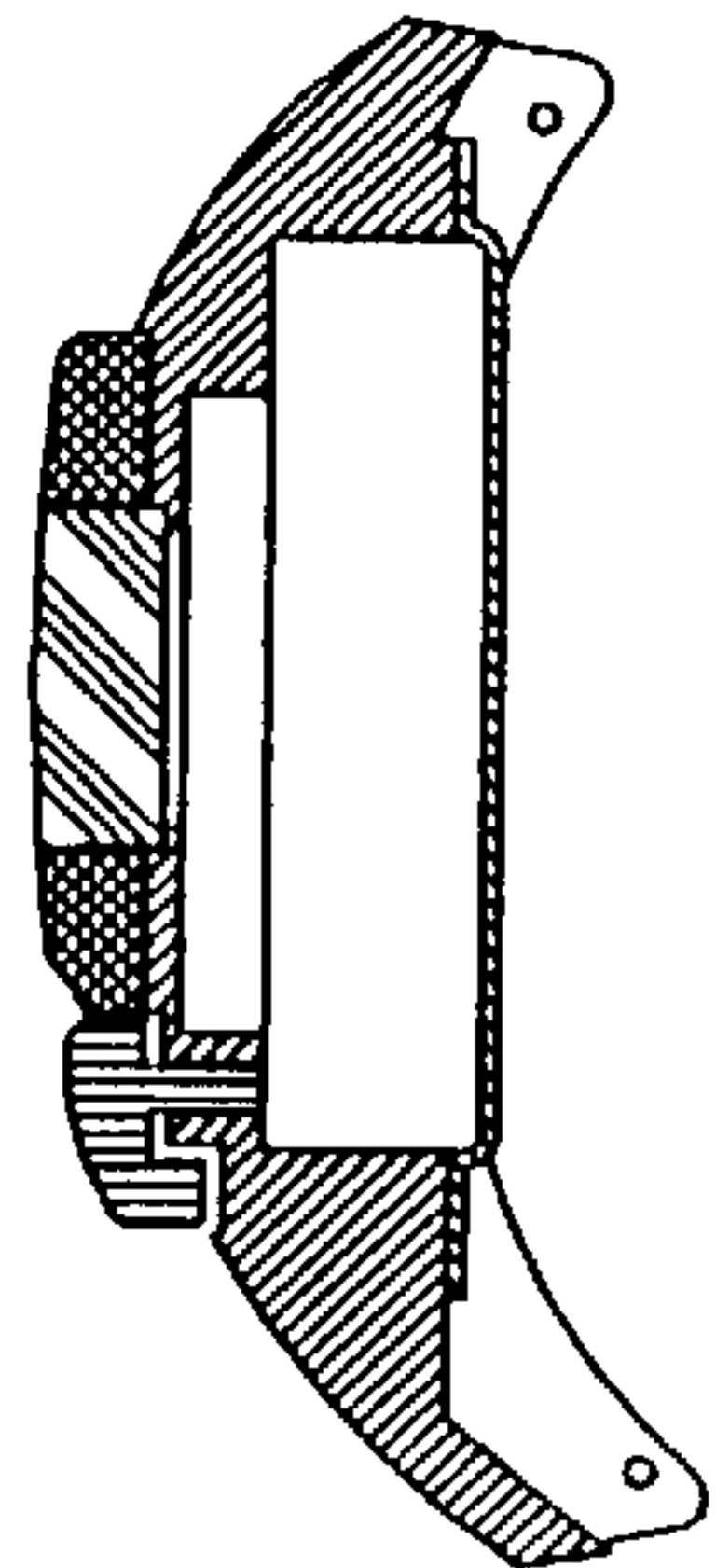

FIG. 14

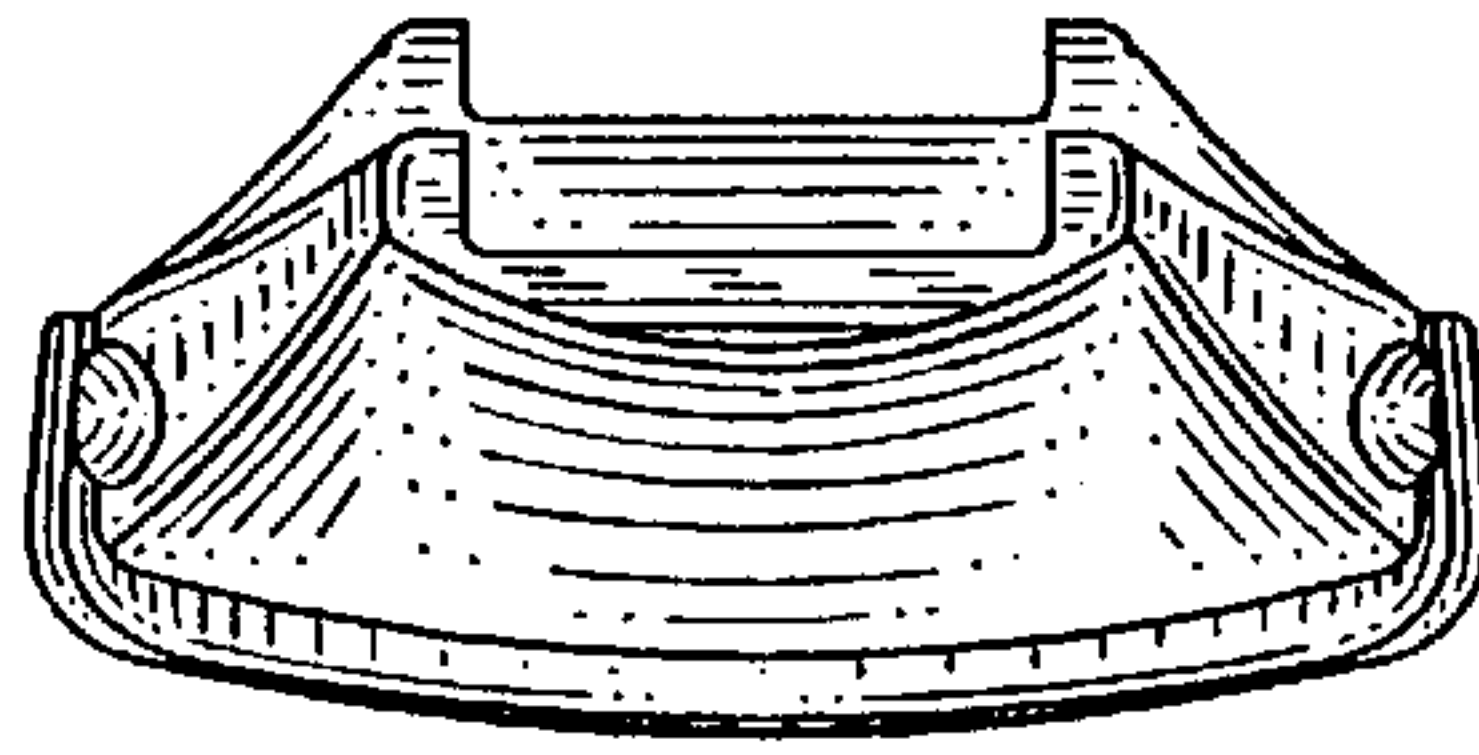

FIG. 17

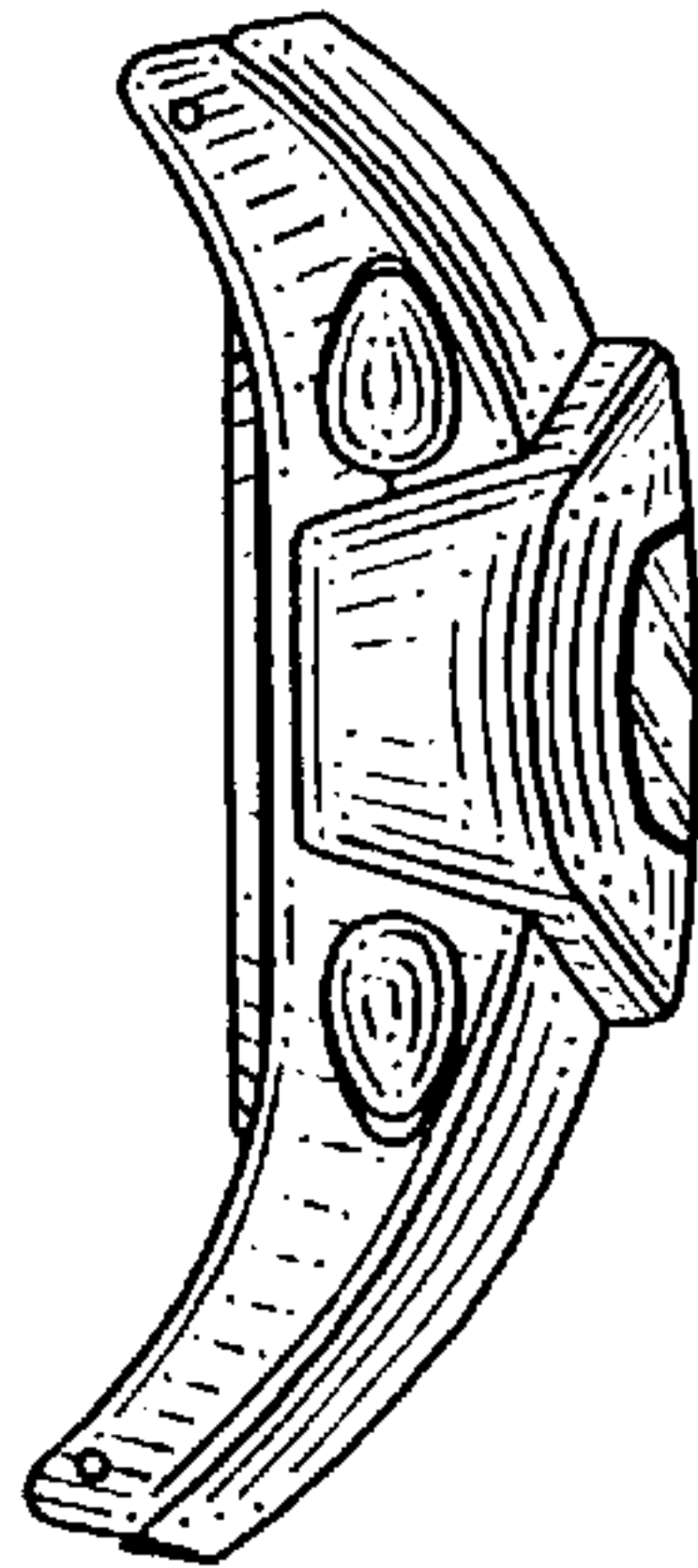

FIG. 19

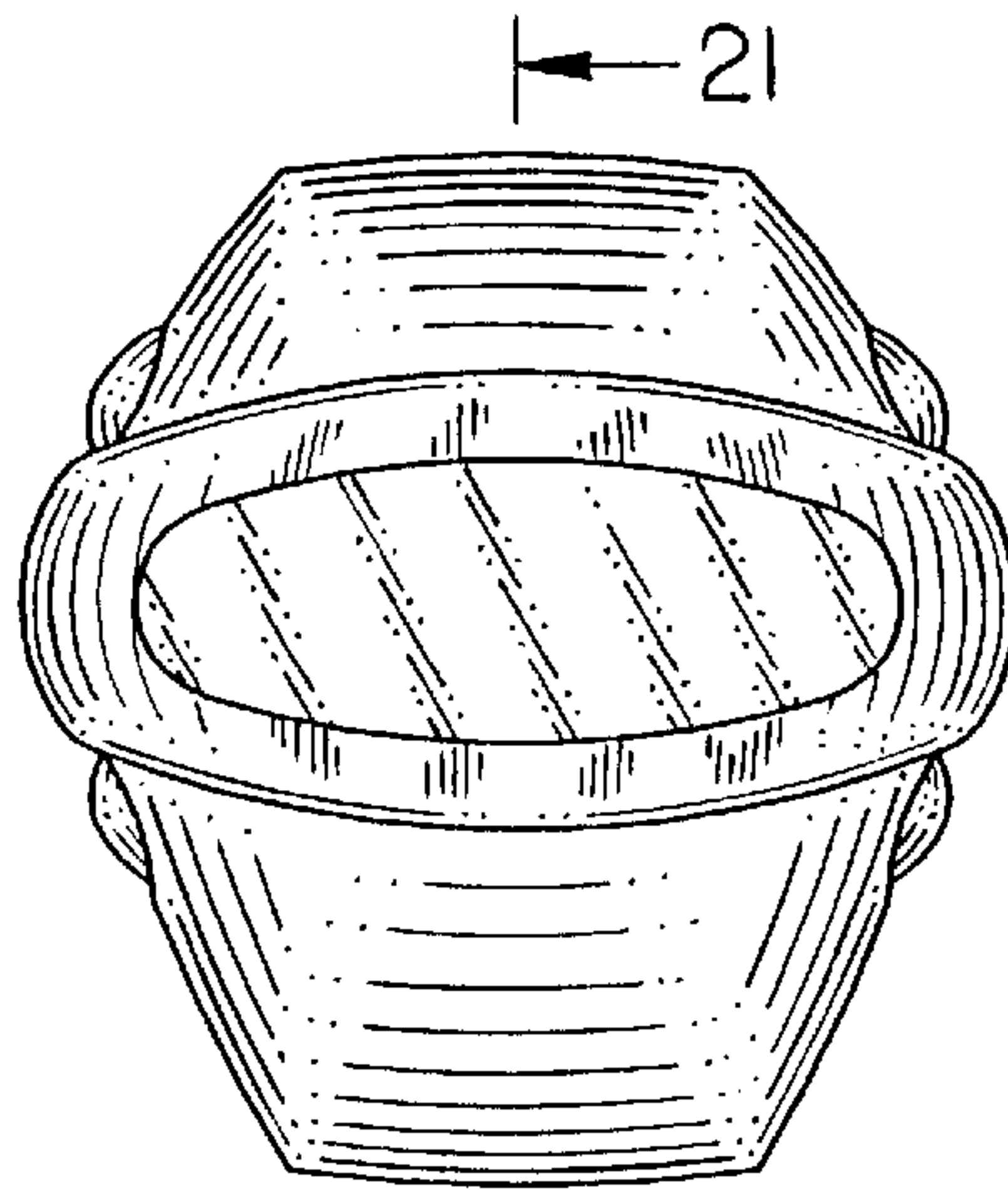

FIG. 15

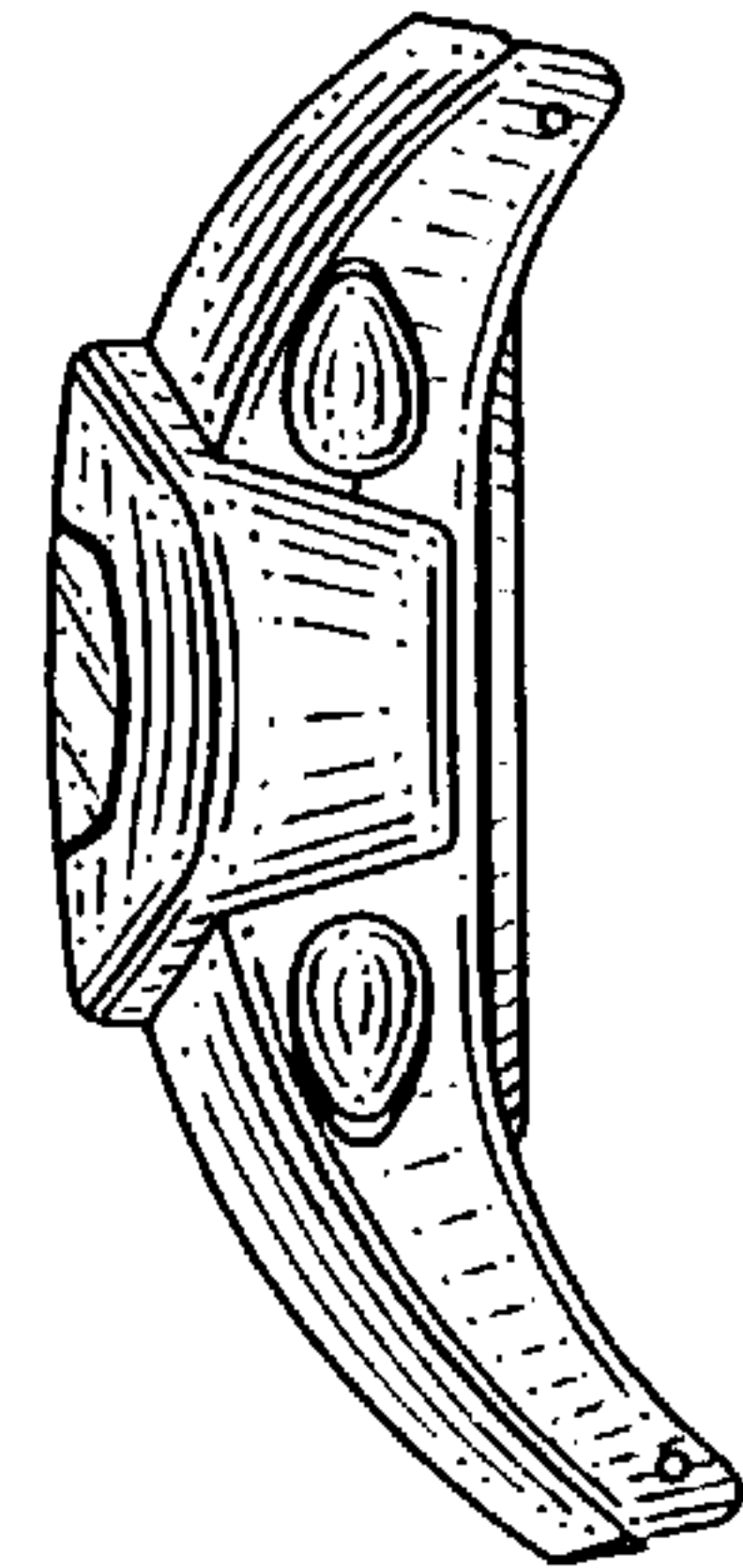

FIG. 20

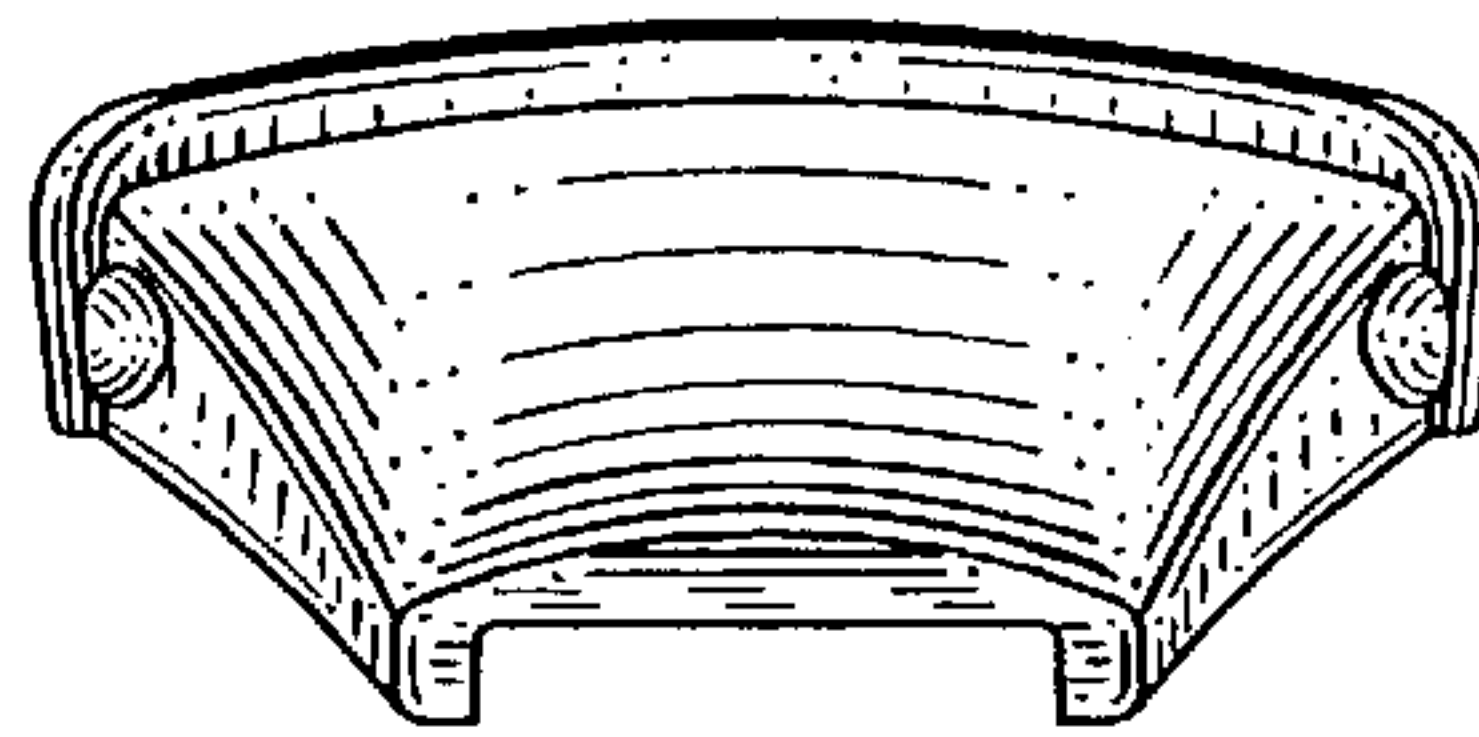

FIG. 18

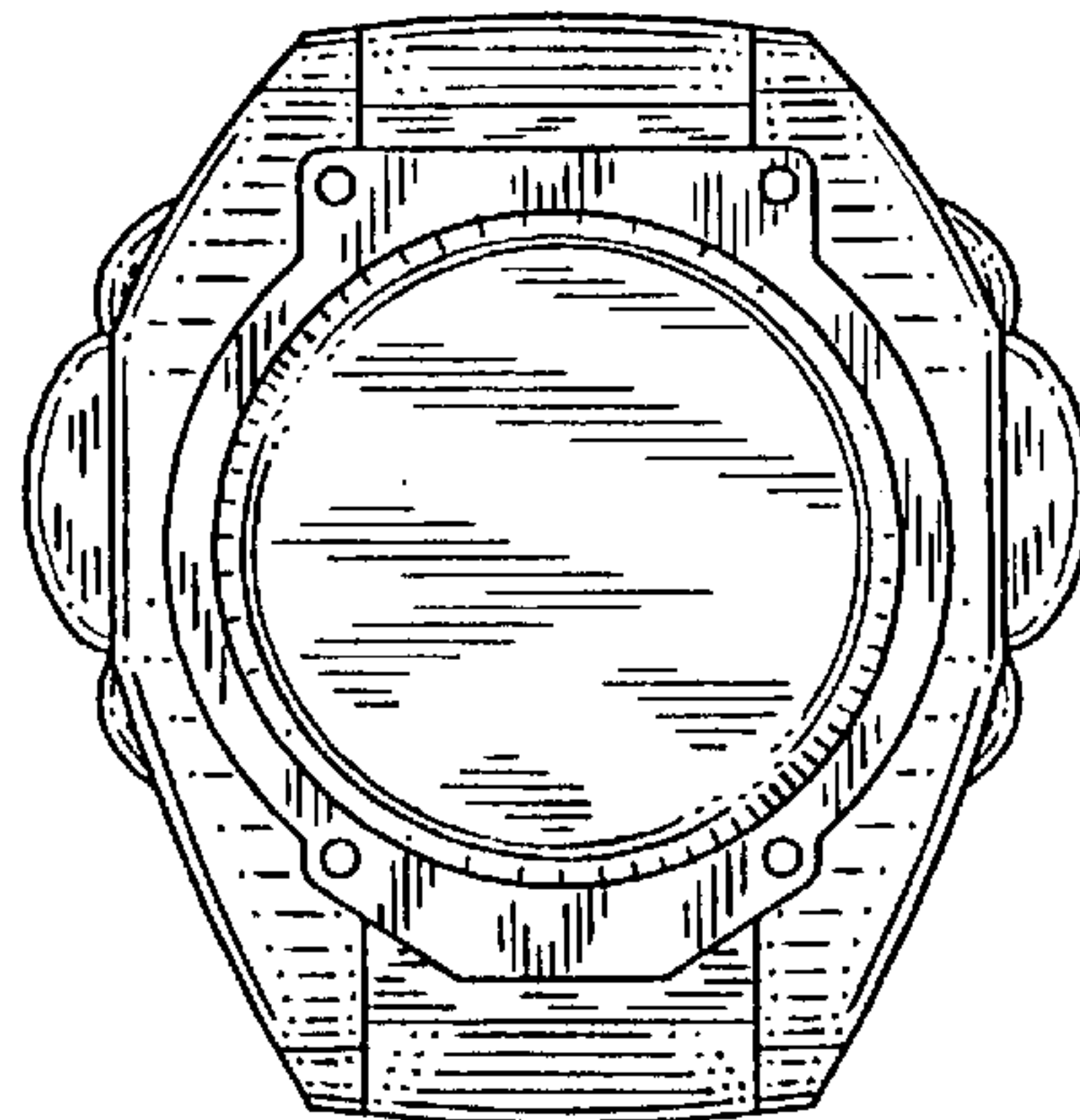

FIG. 16

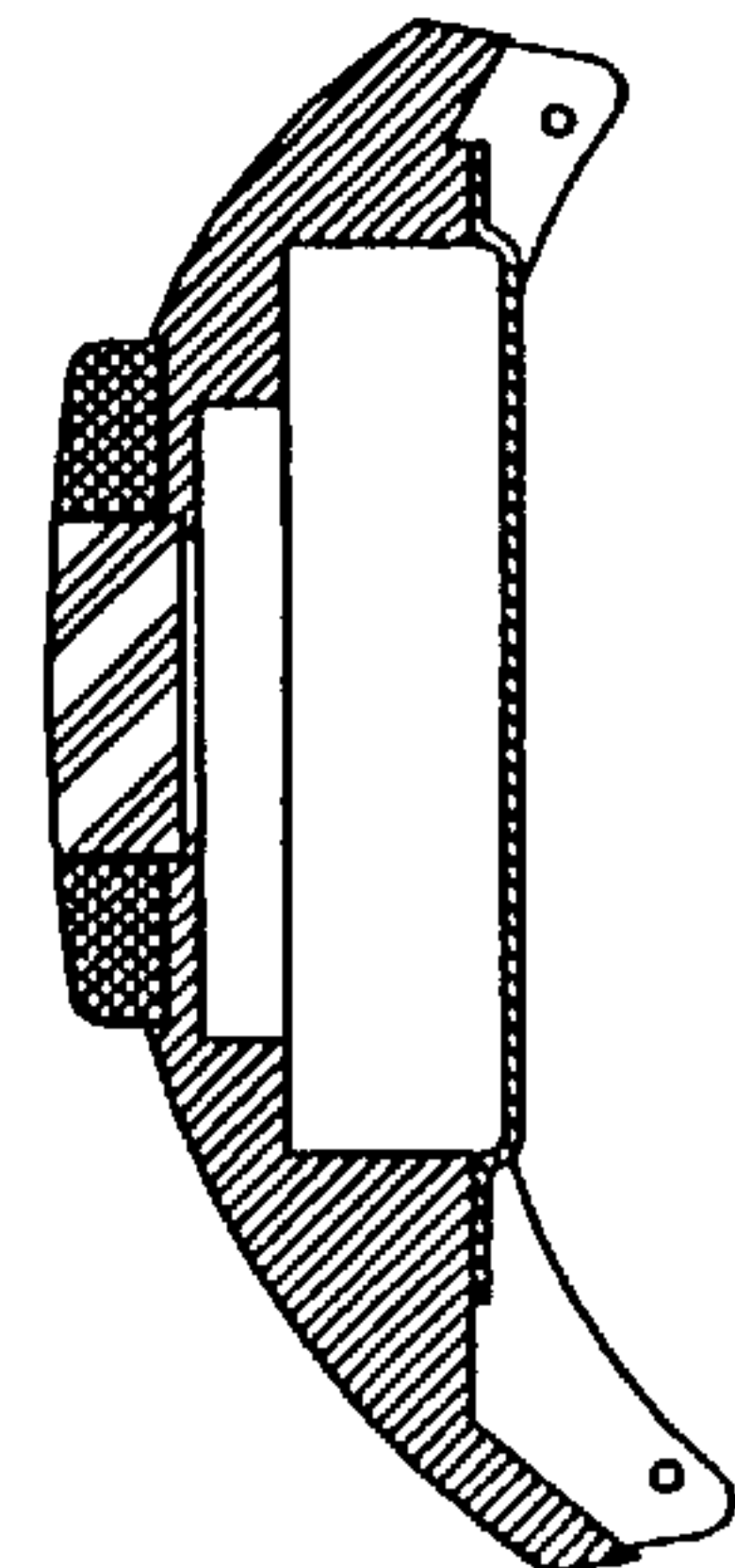

FIG. 21

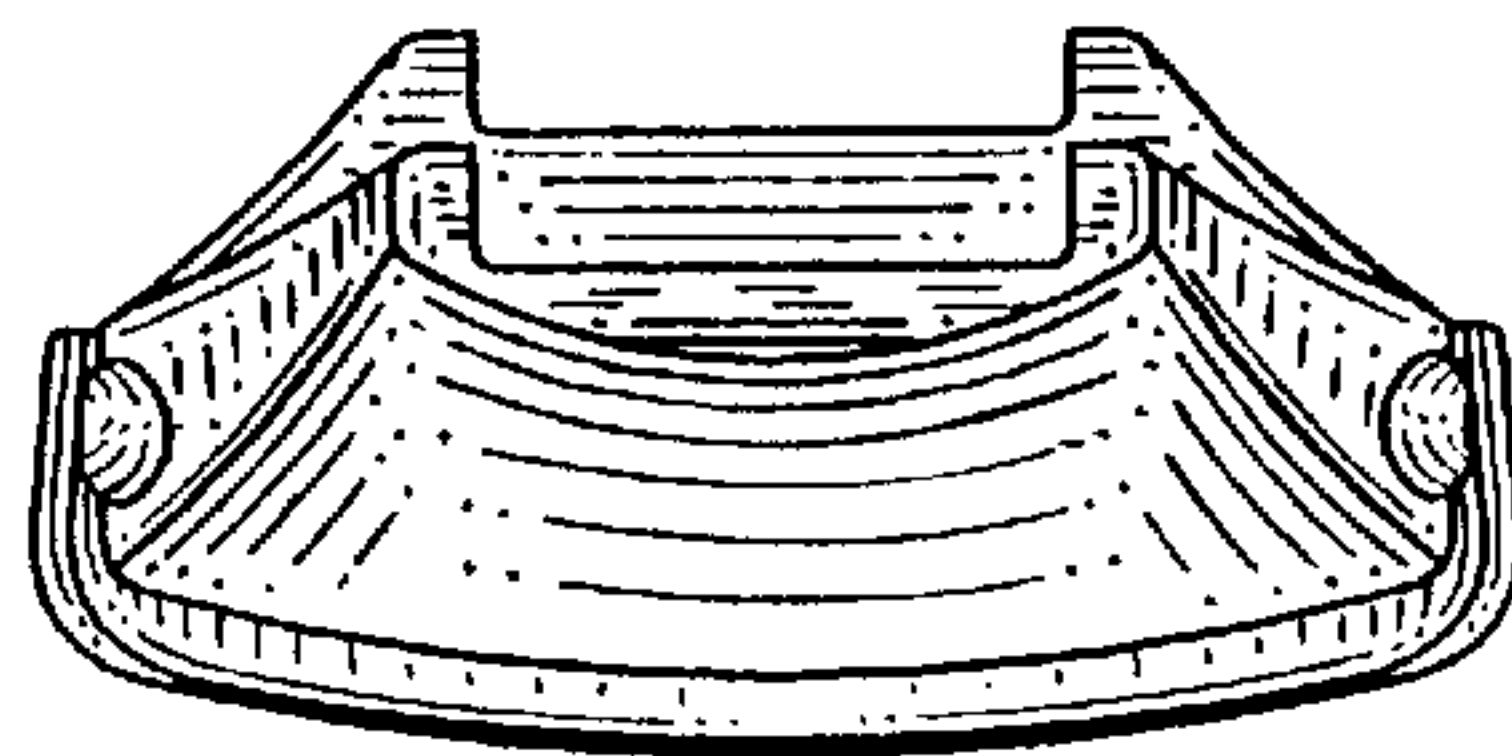

FIG. 24

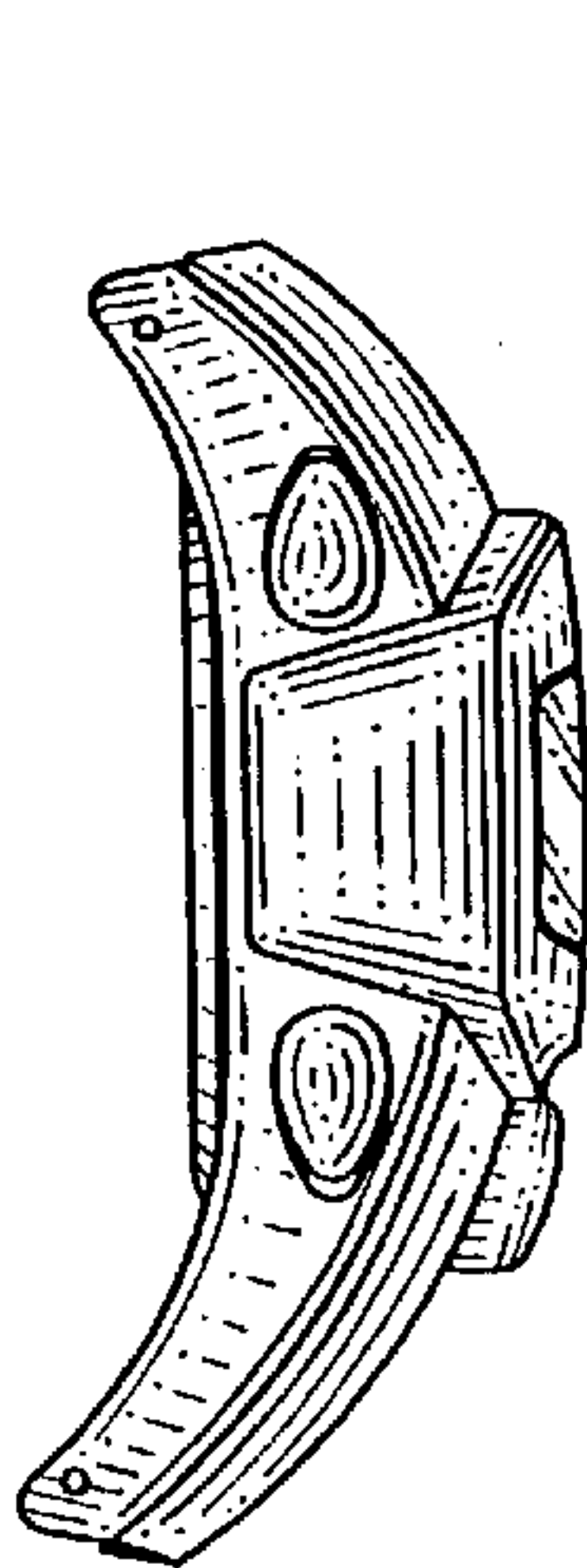

FIG. 26

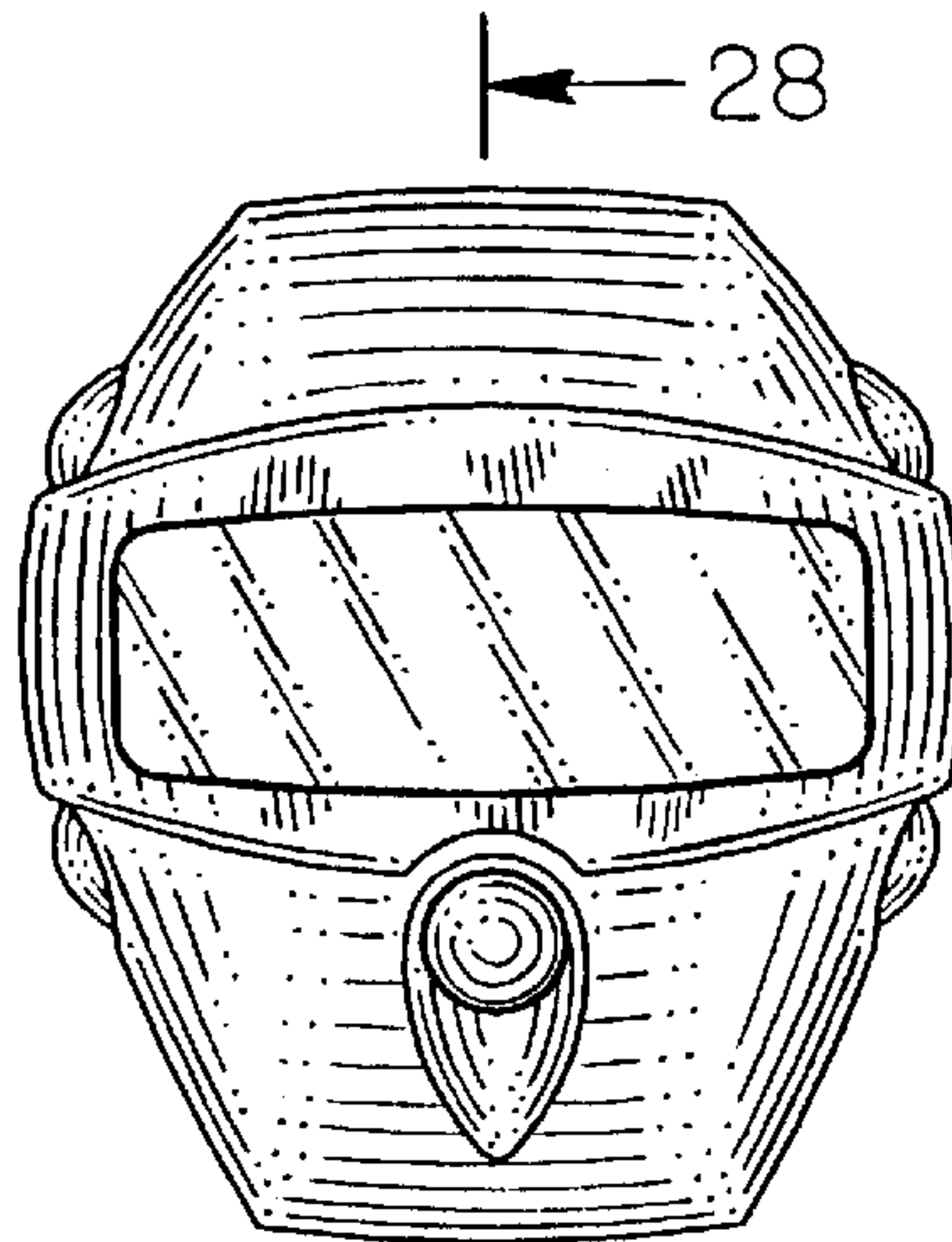

FIG. 22

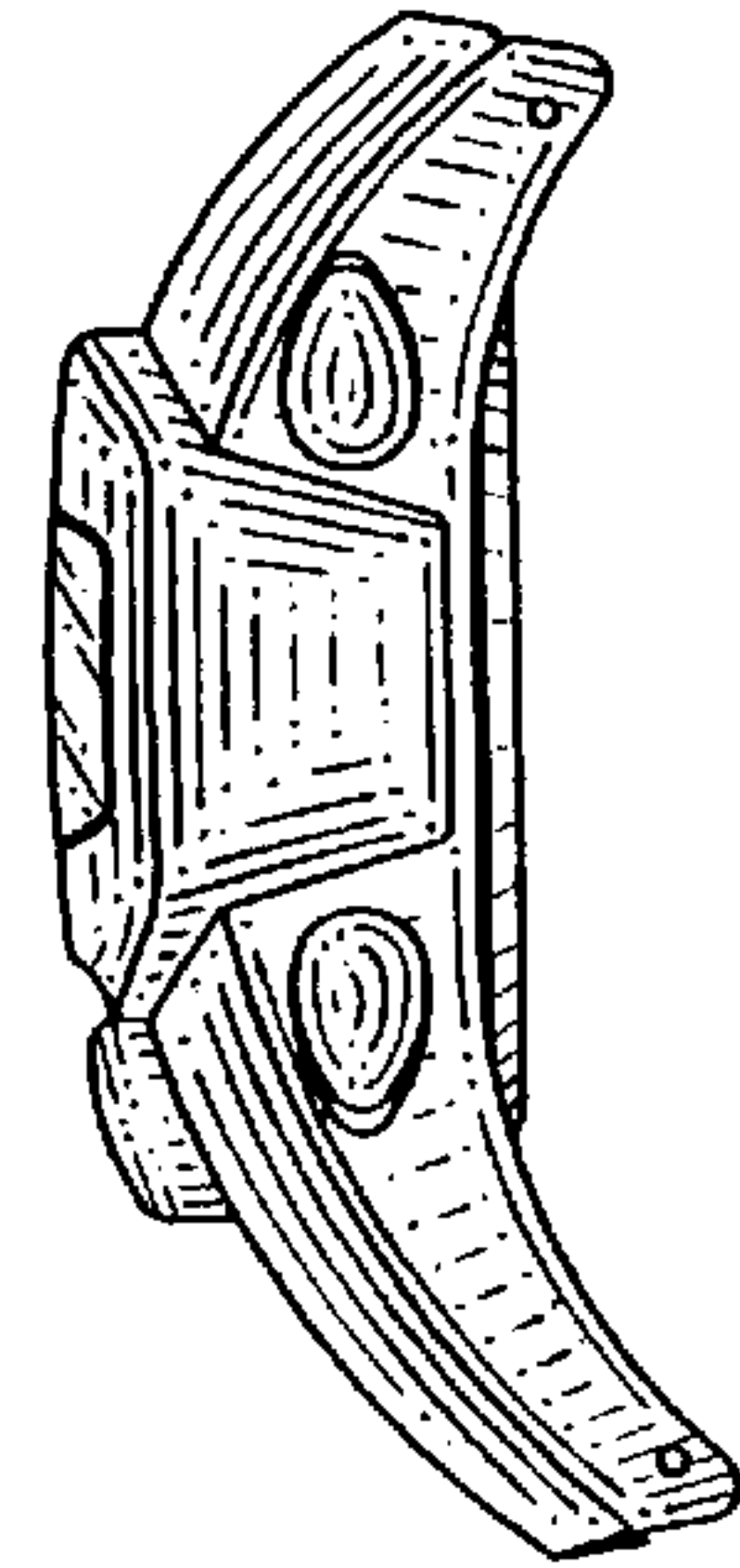

FIG. 27

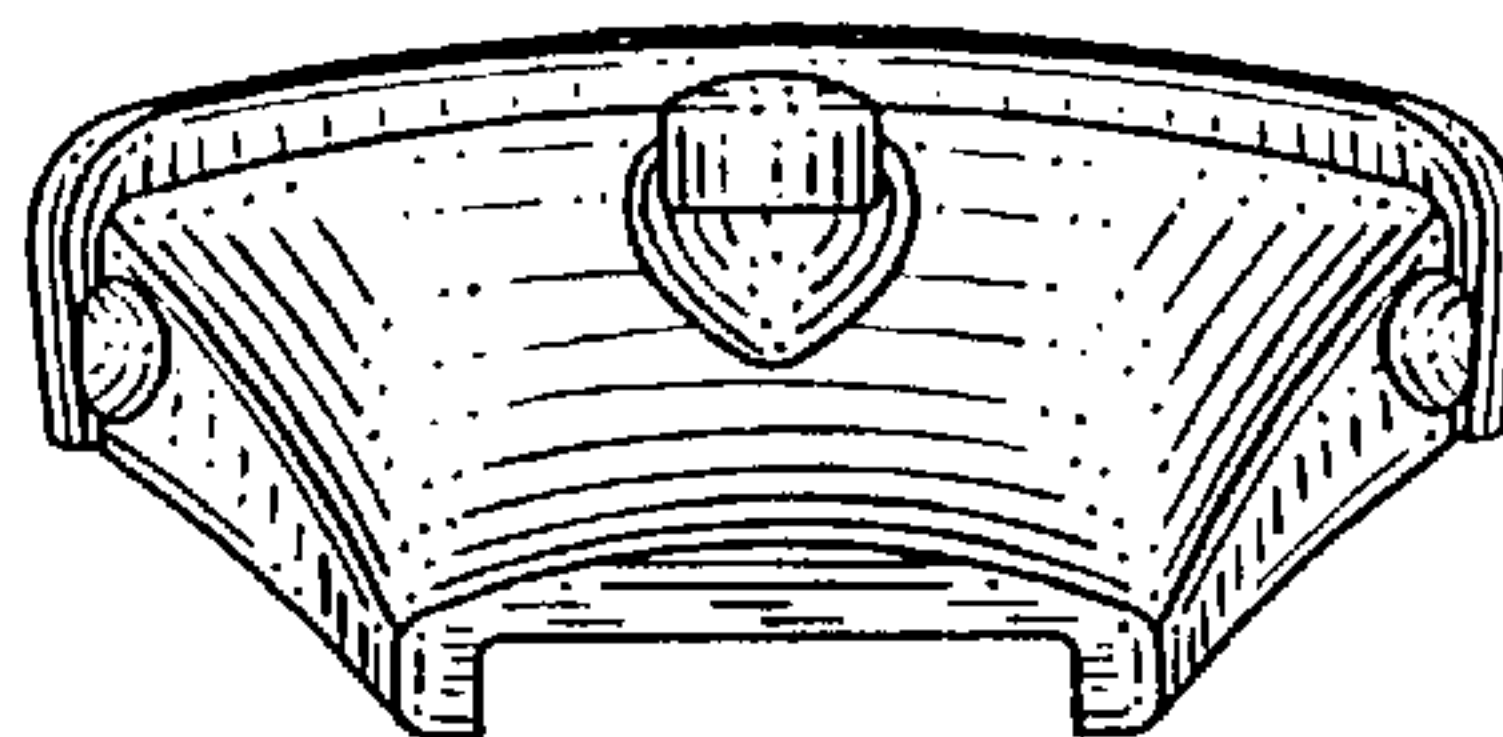

FIG. 25

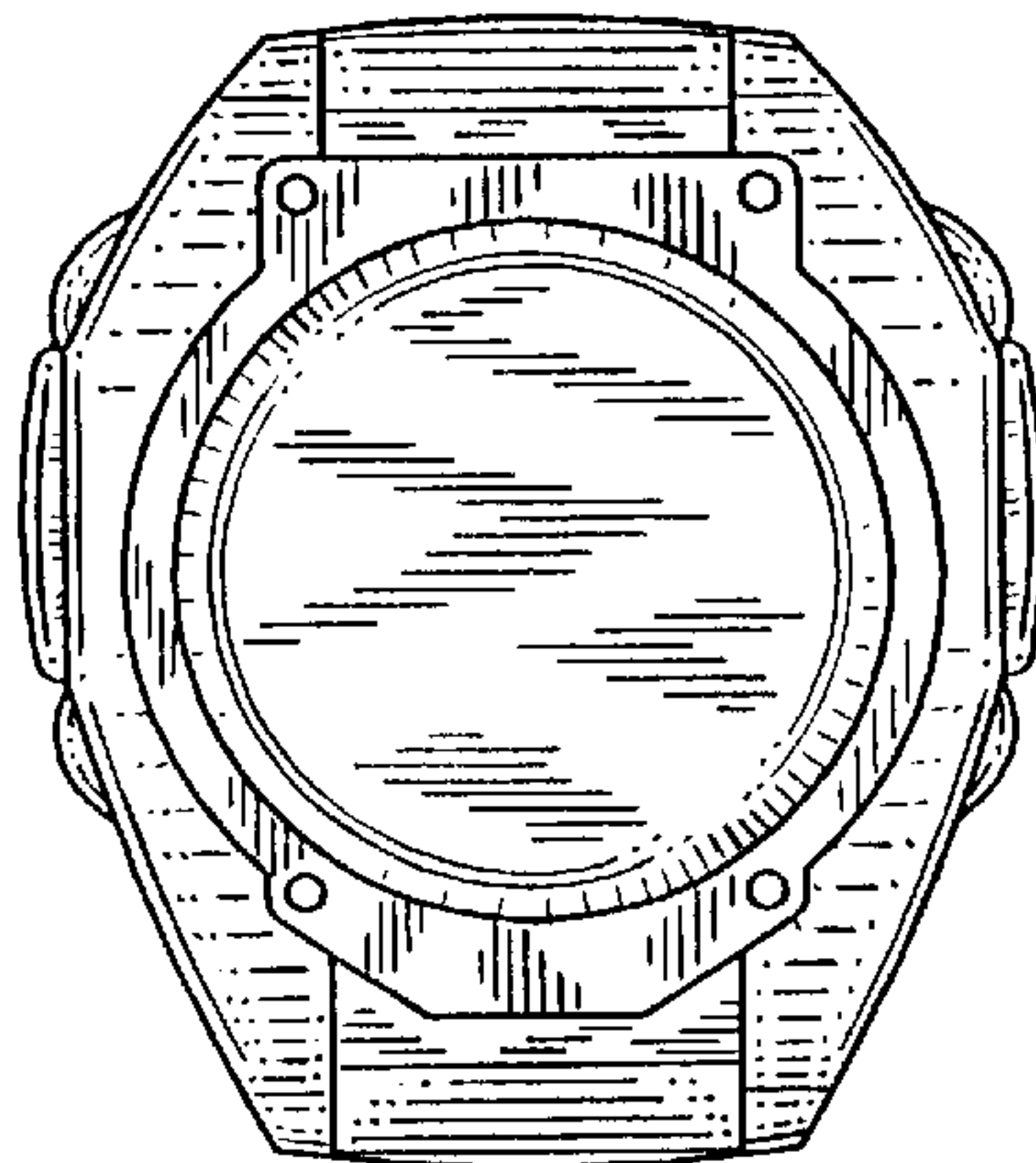

FIG. 23

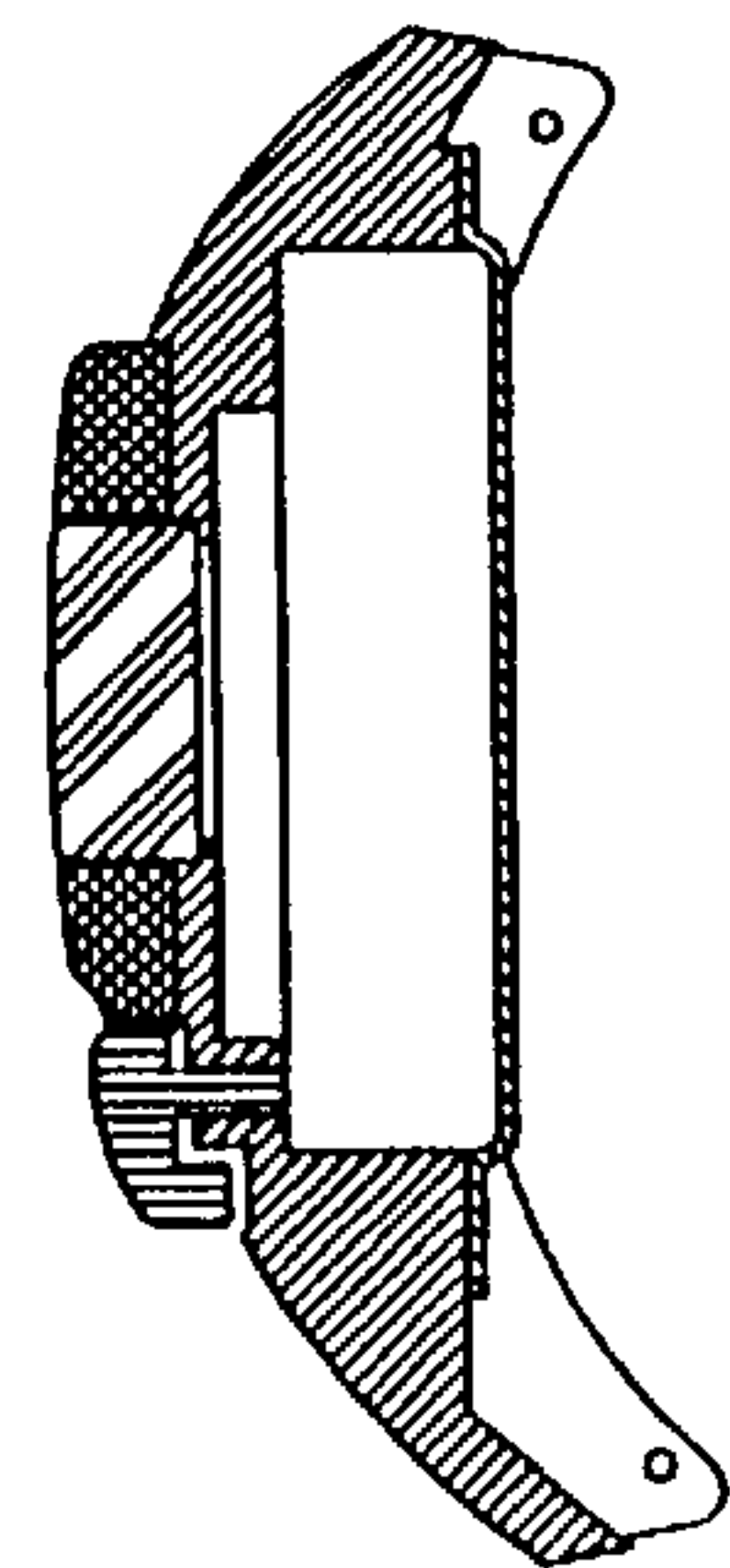

FIG. 28

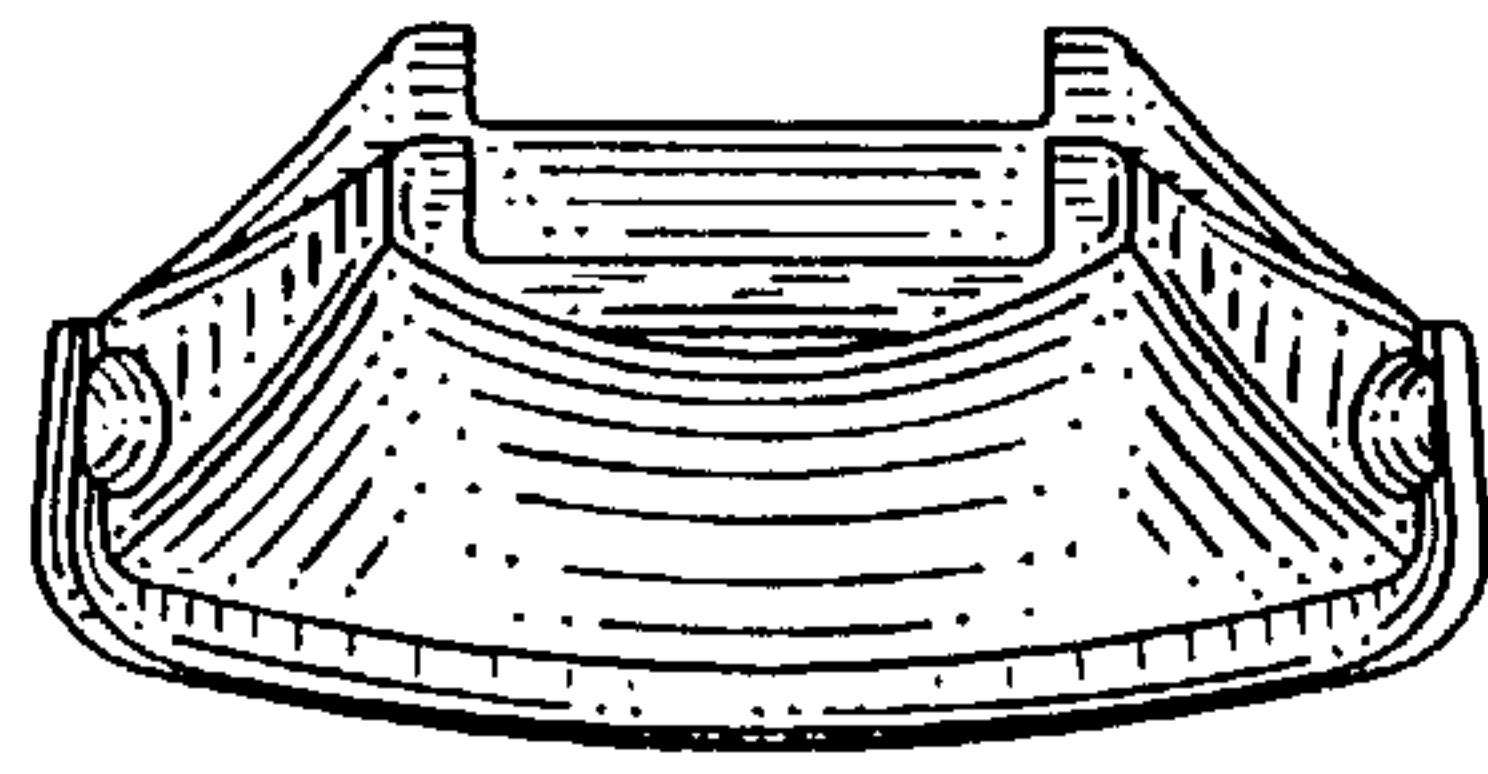

FIG. 31

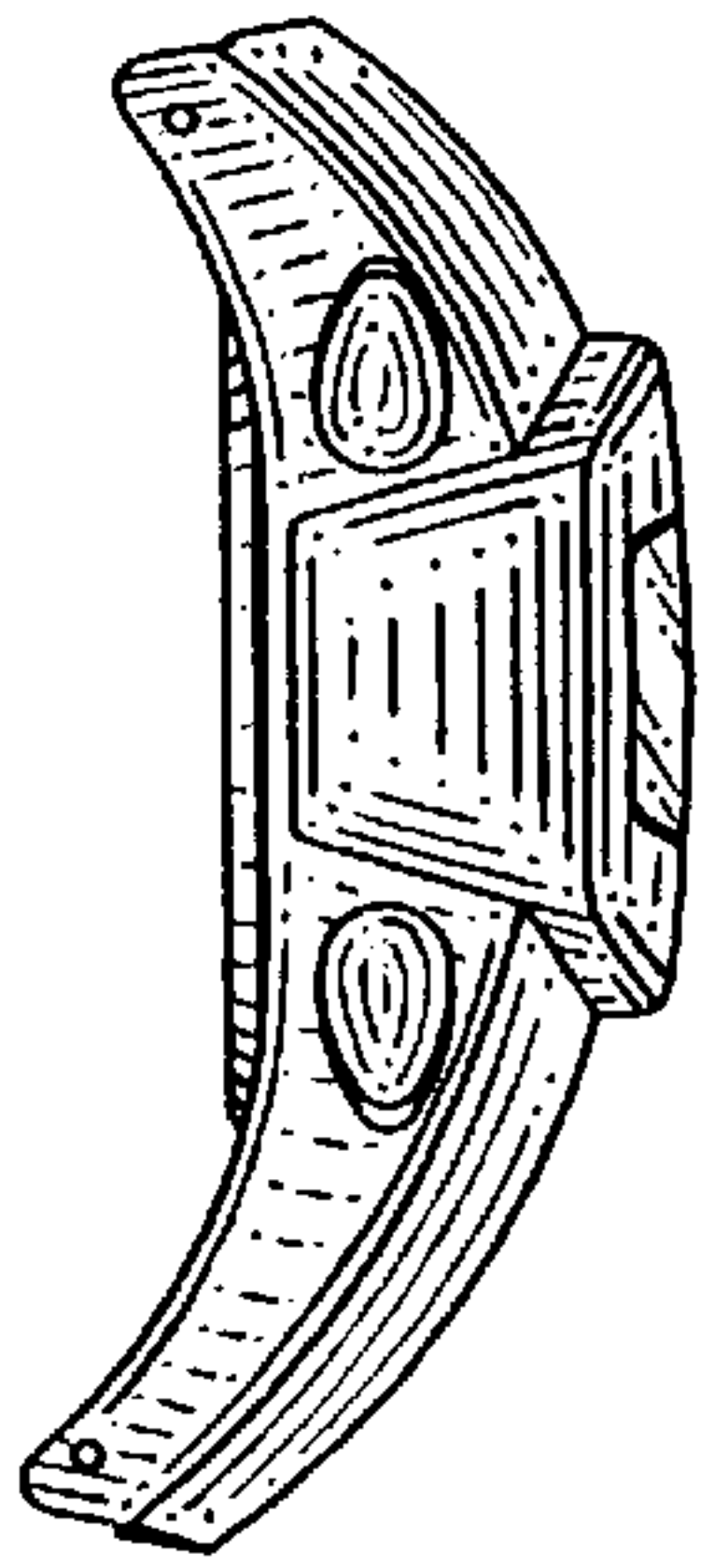

FIG. 33

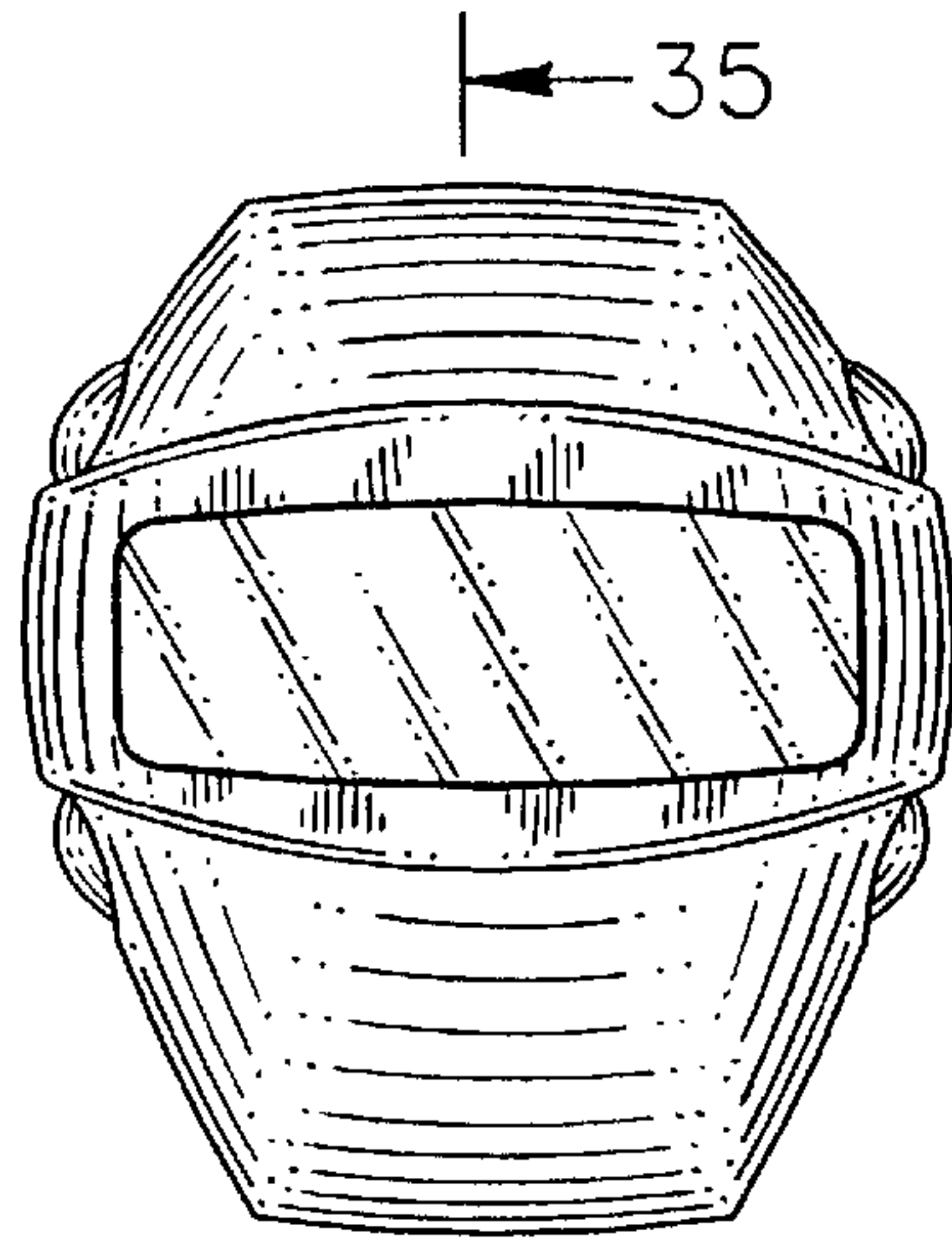

FIG. 29

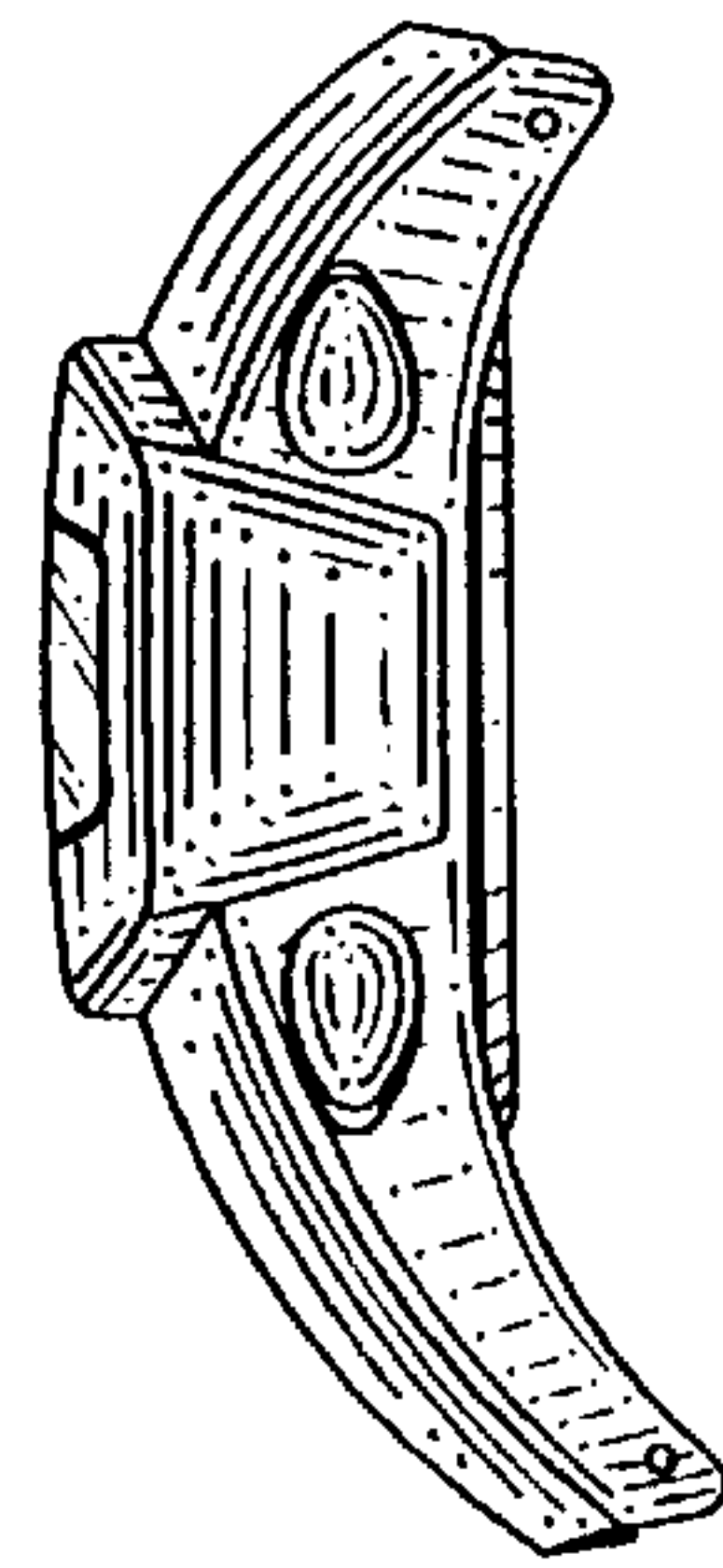

FIG. 34

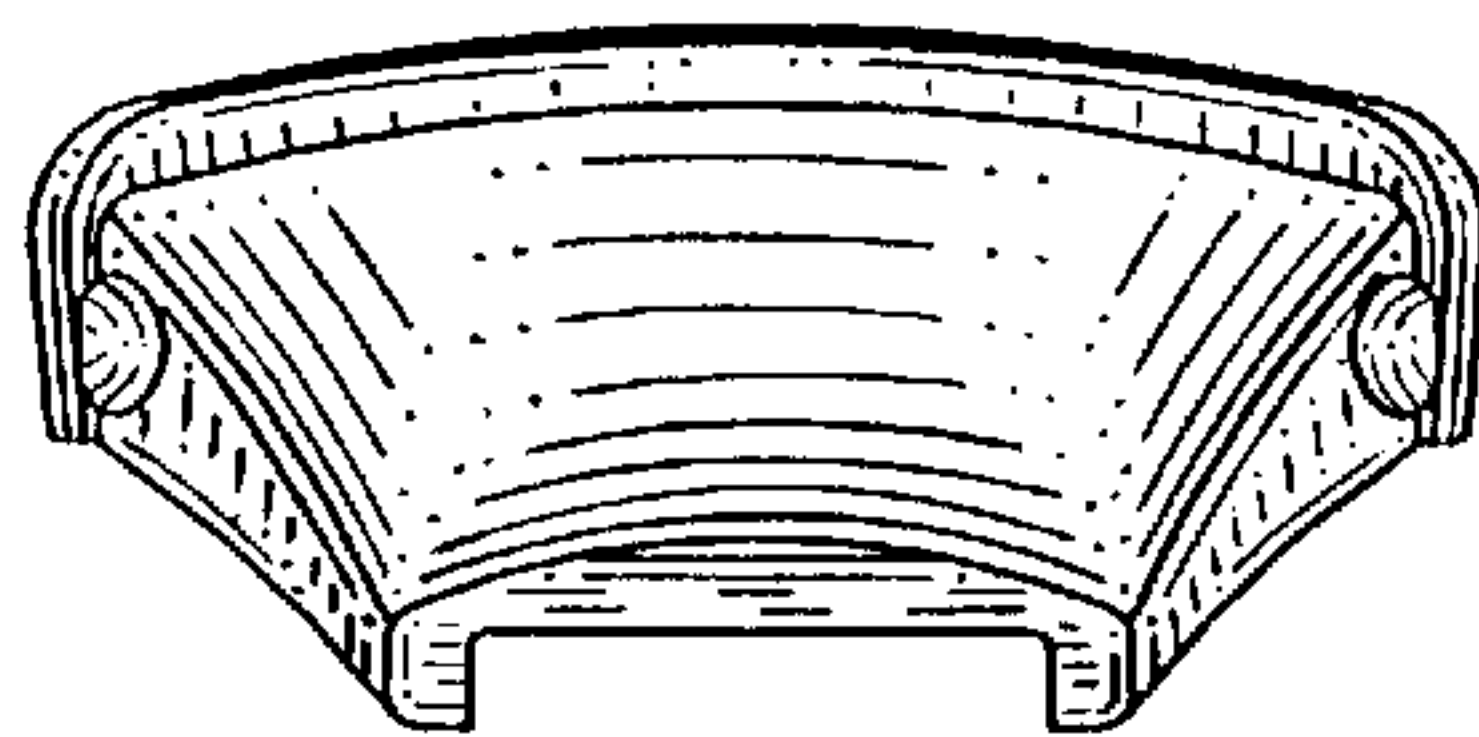

FIG. 32

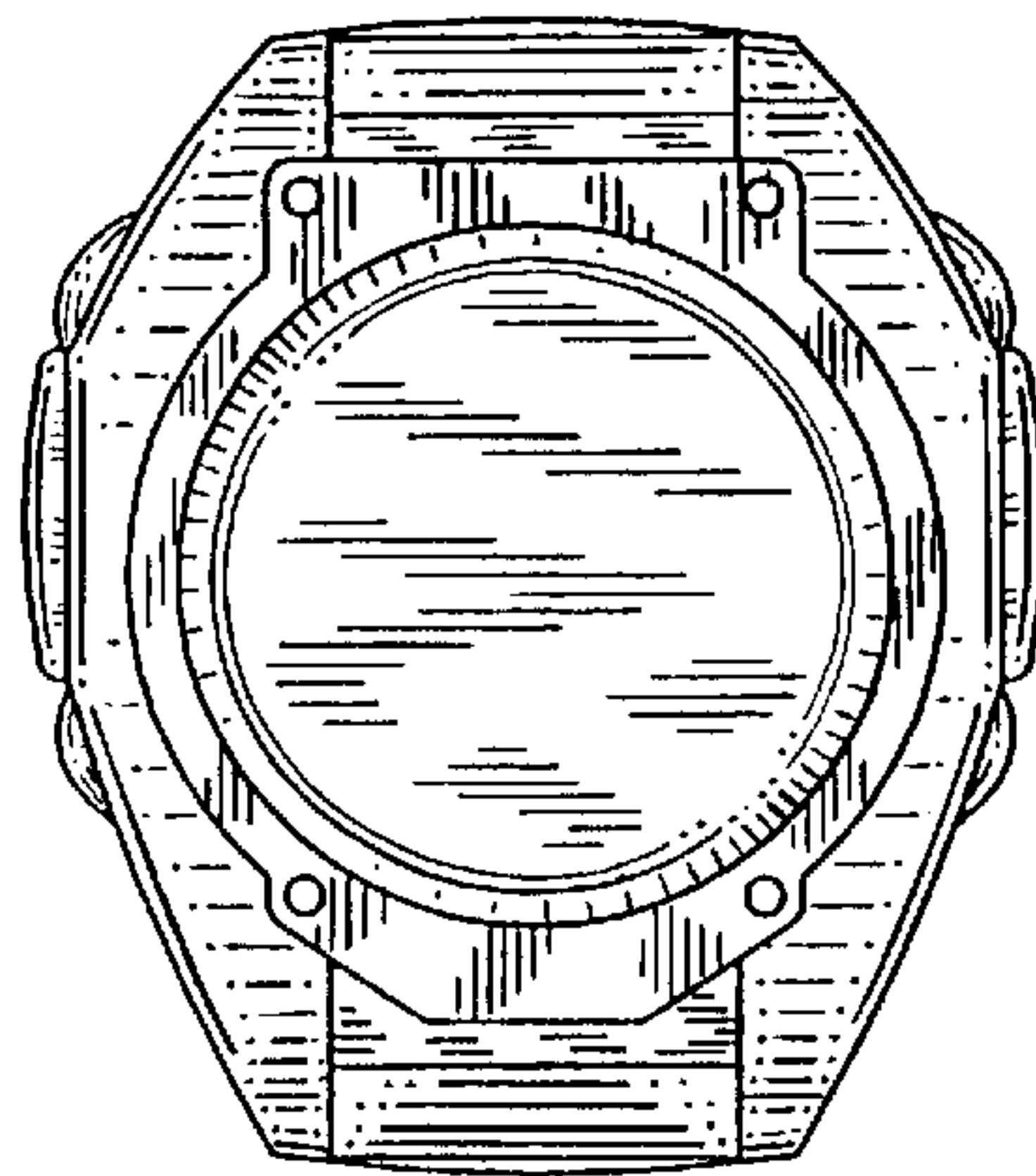

FIG. 30

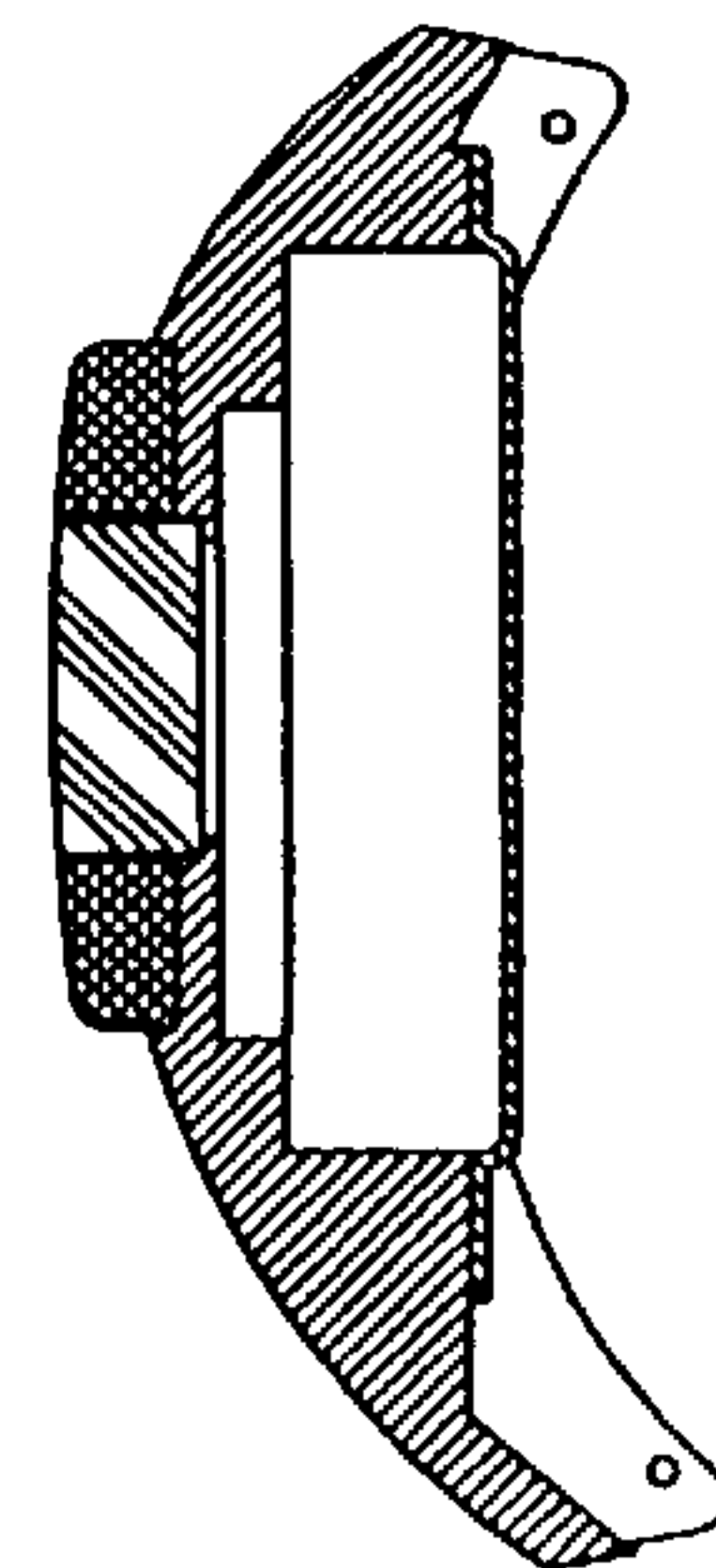

FIG. 35

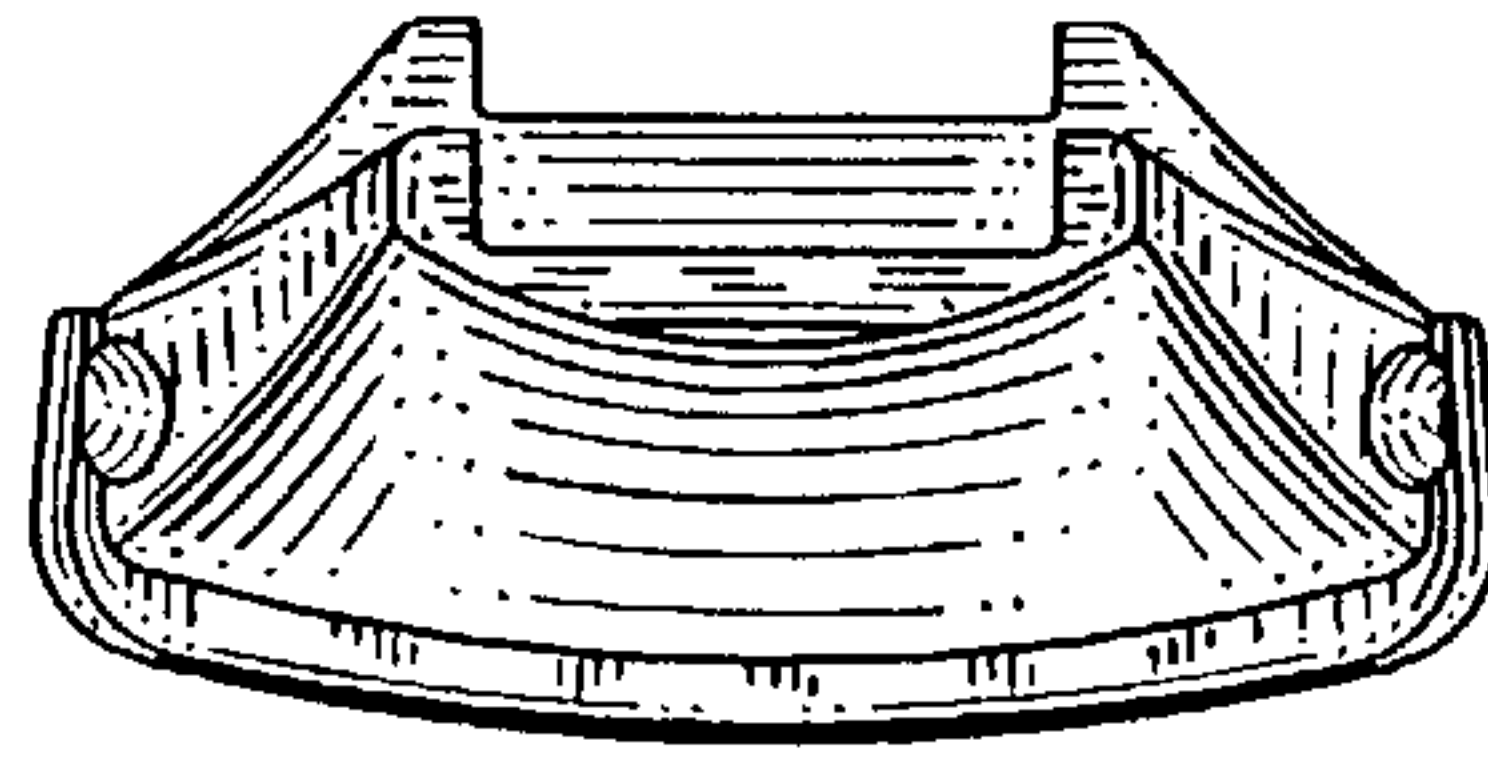

FIG. 38

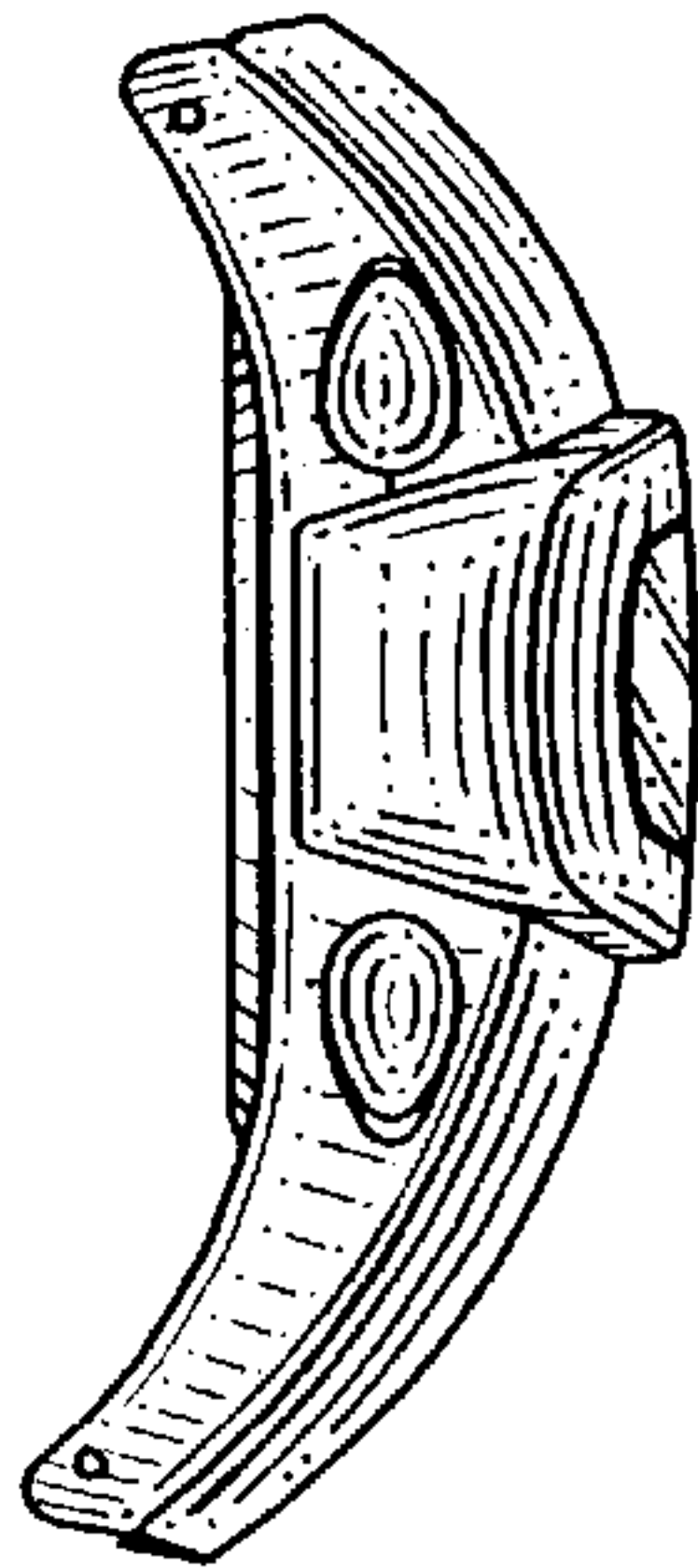

FIG. 40

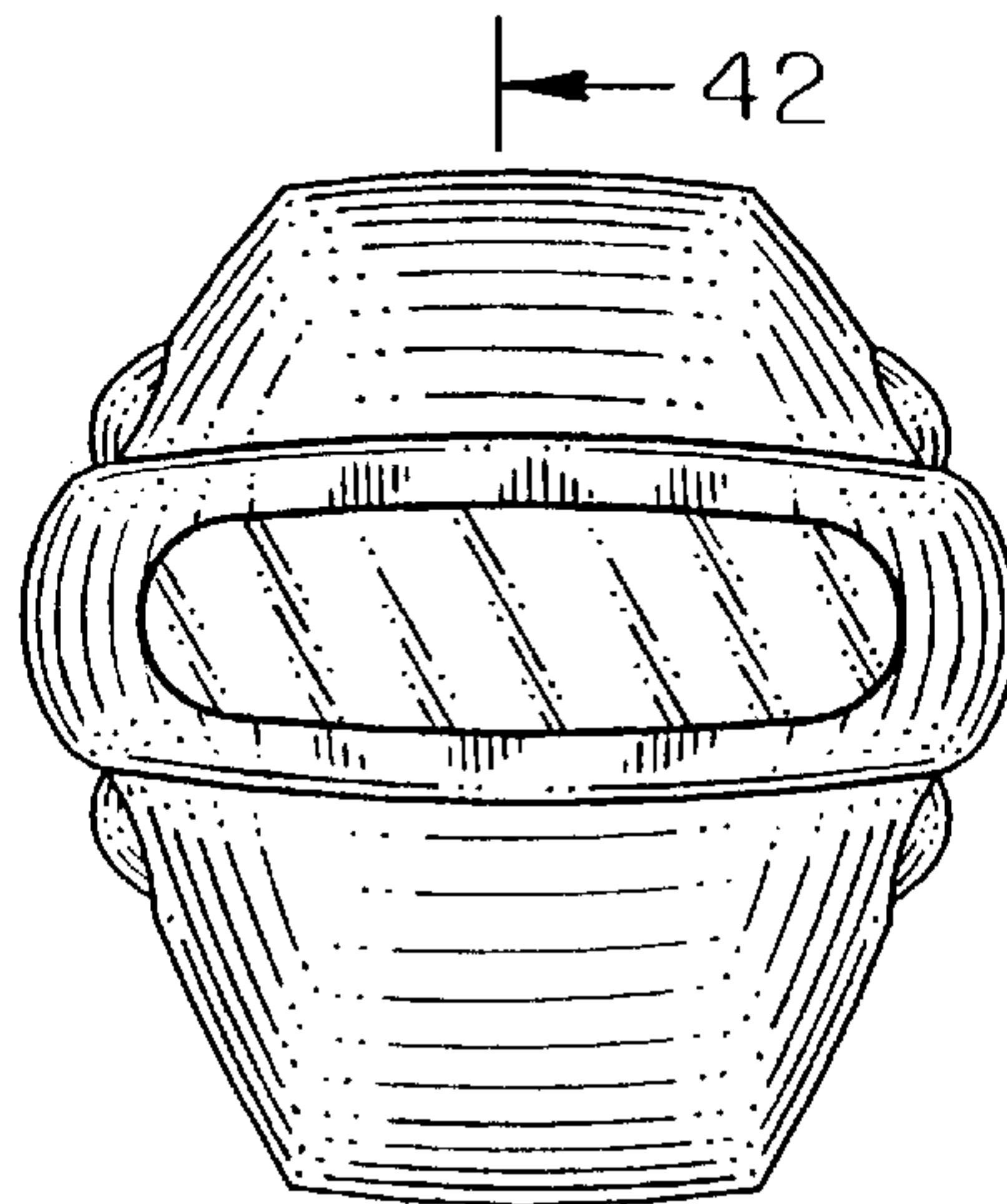

FIG. 36

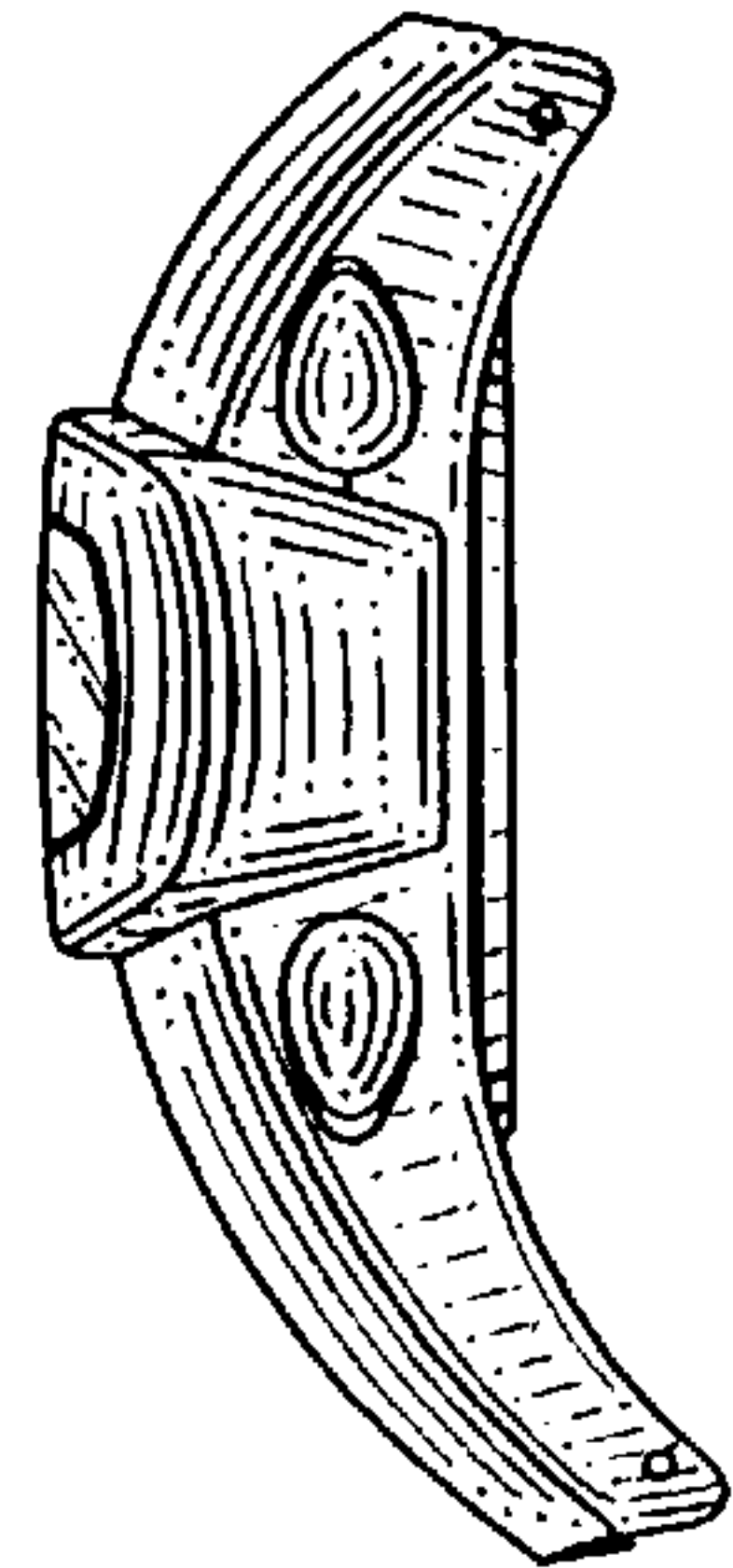

FIG. 41

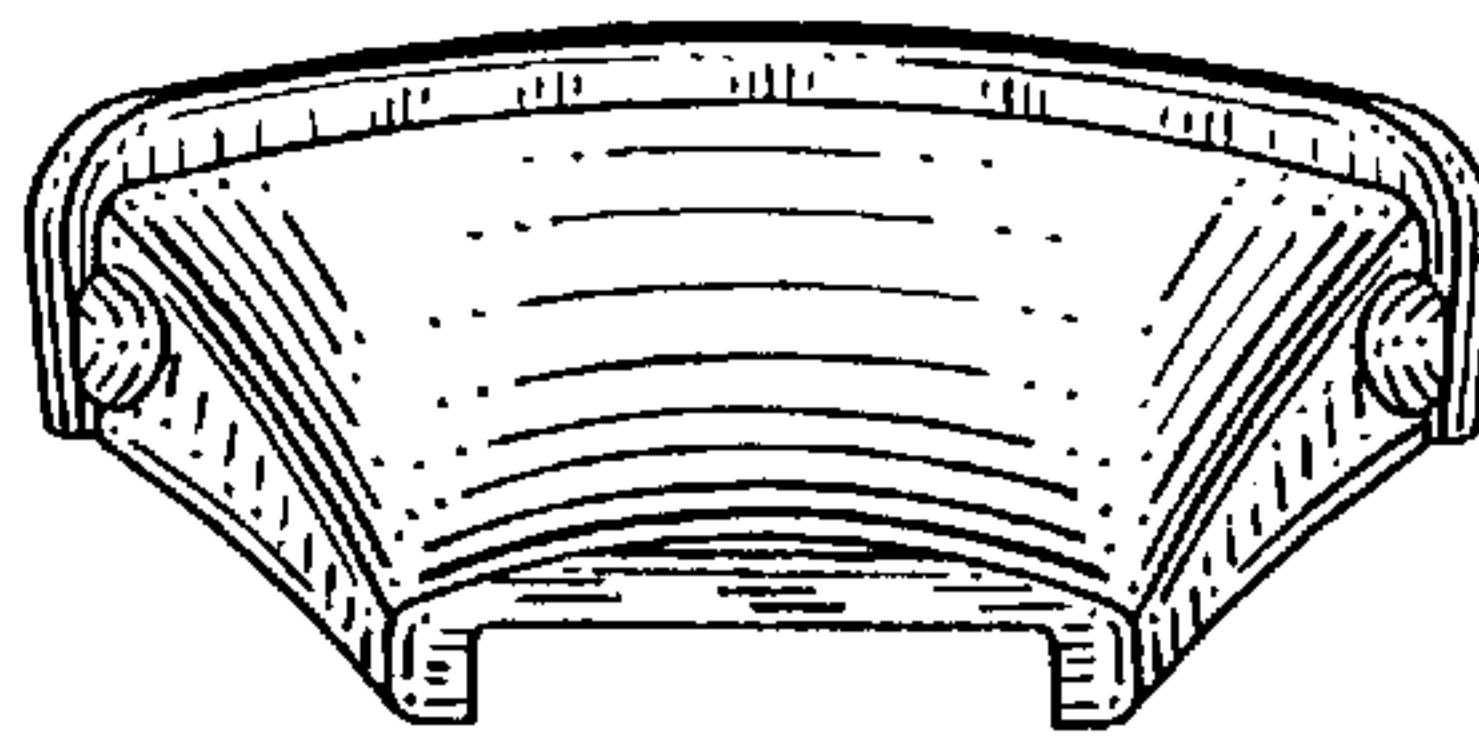

FIG. 39

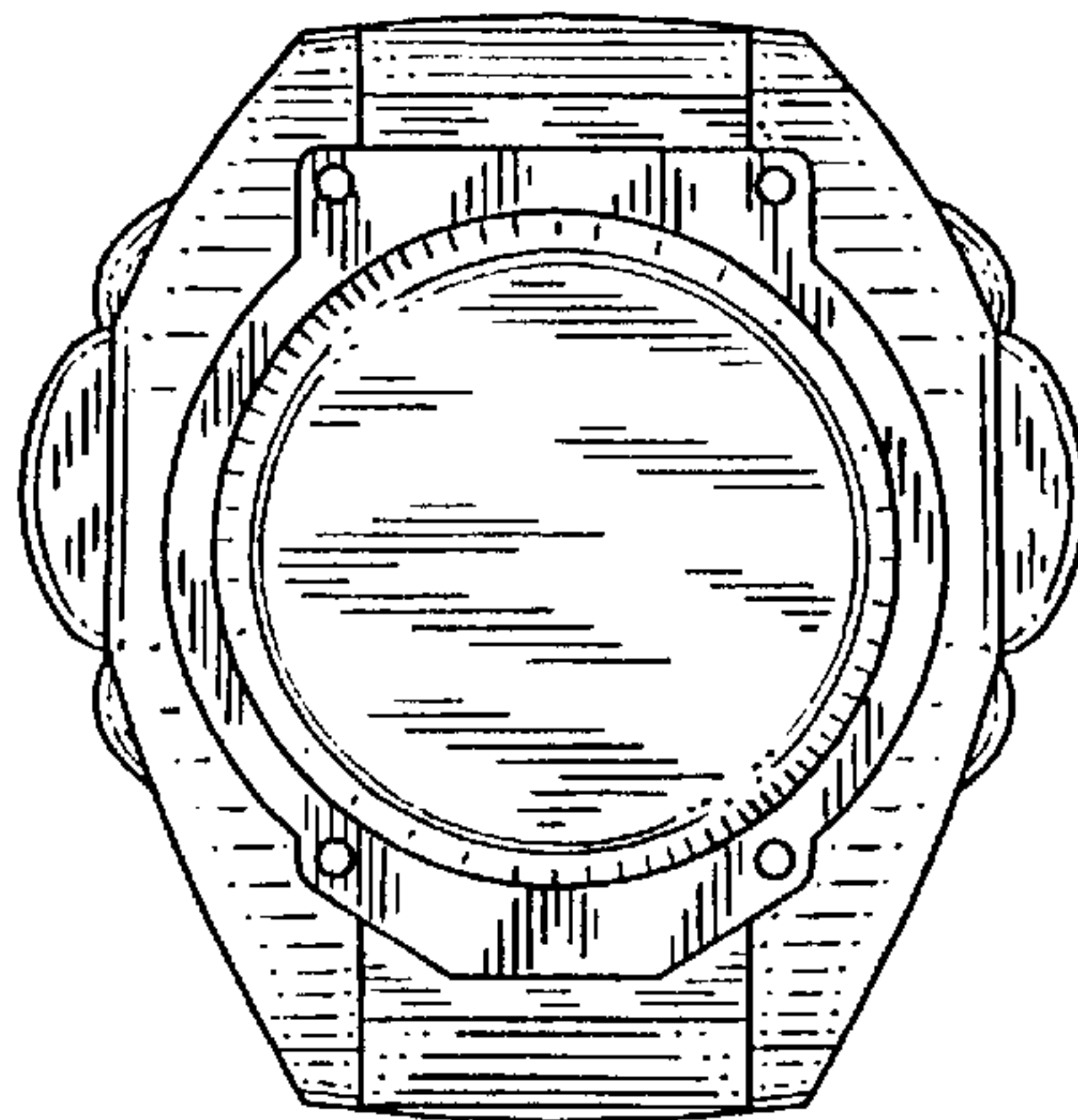

FIG. 37

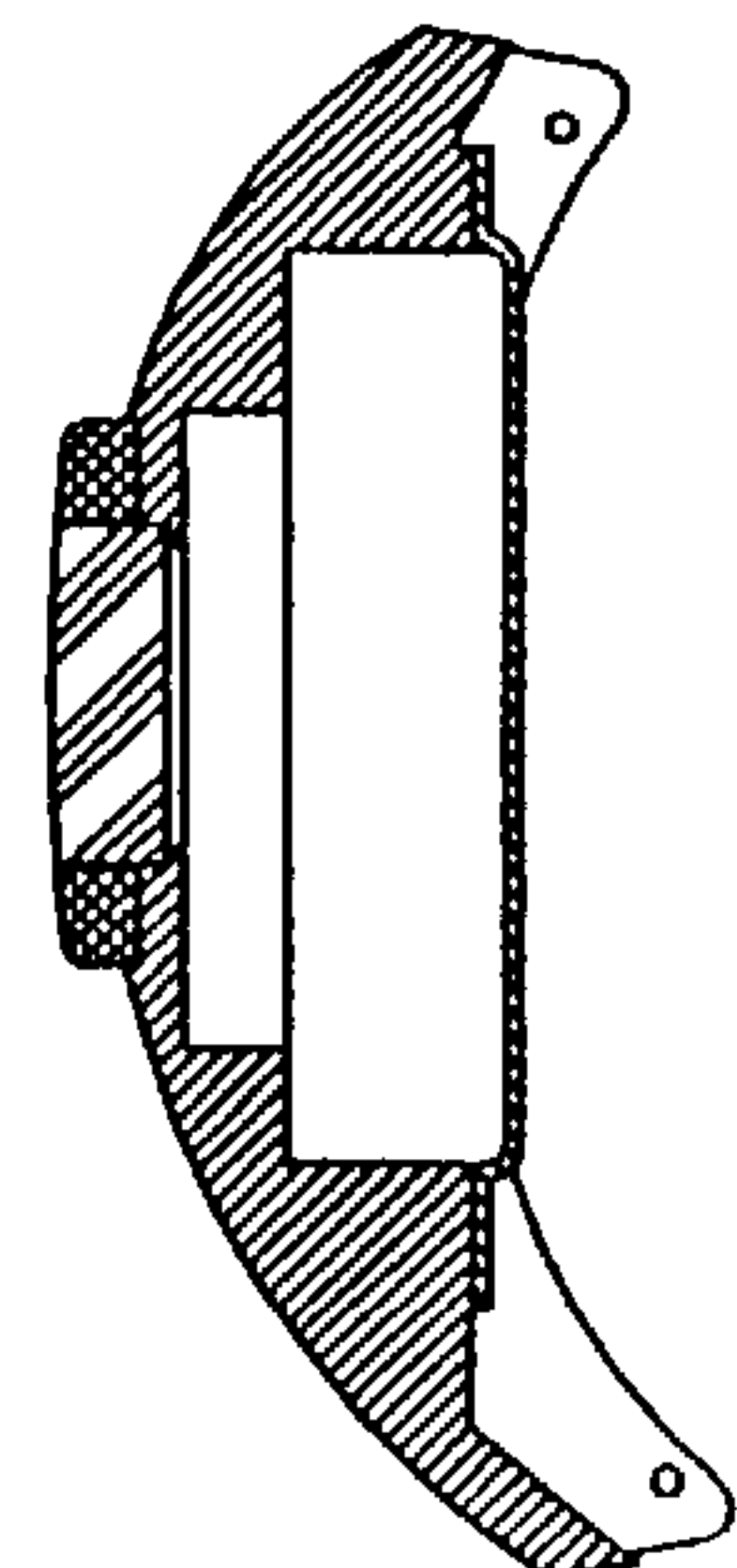

FIG. 42

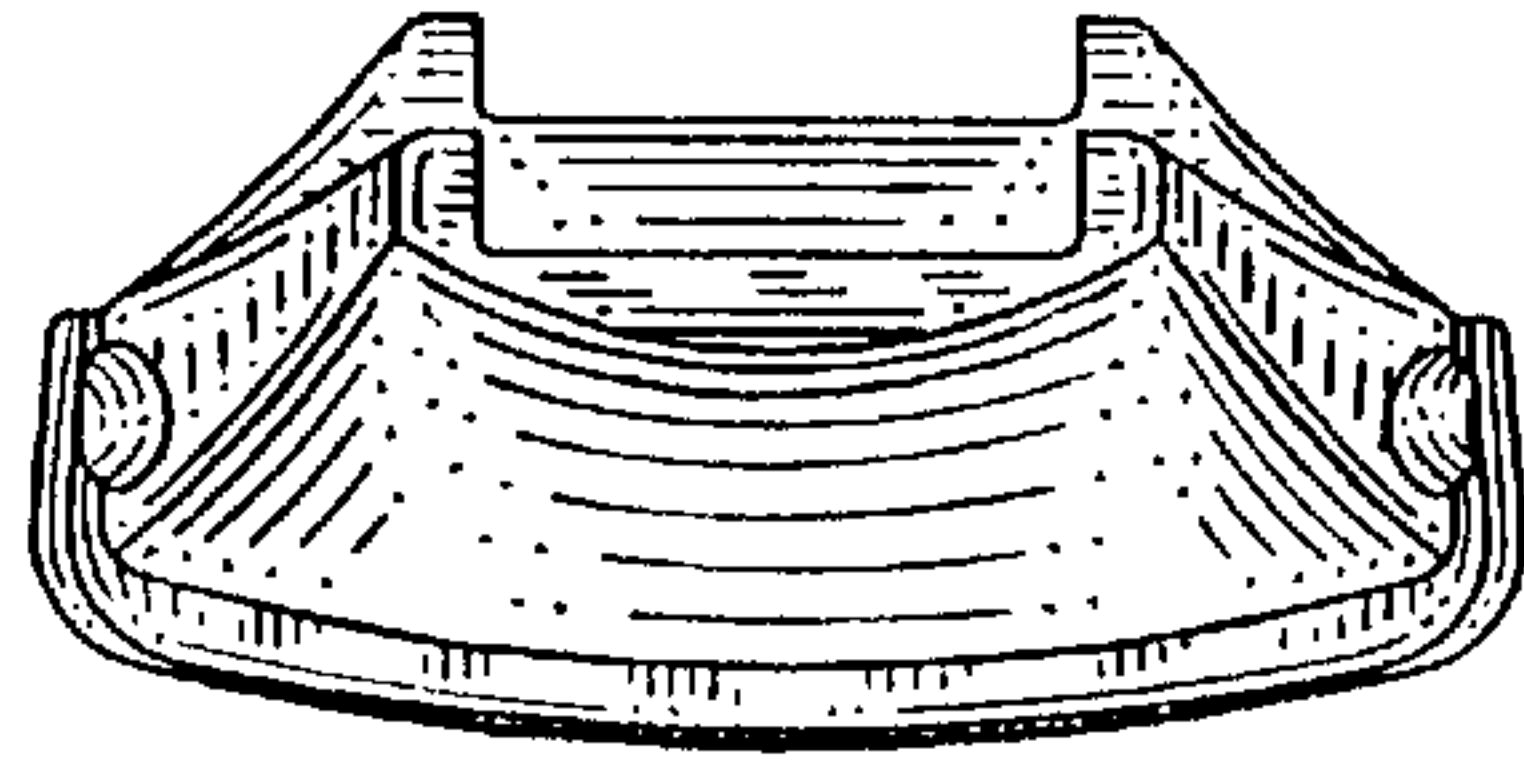

FIG. 45

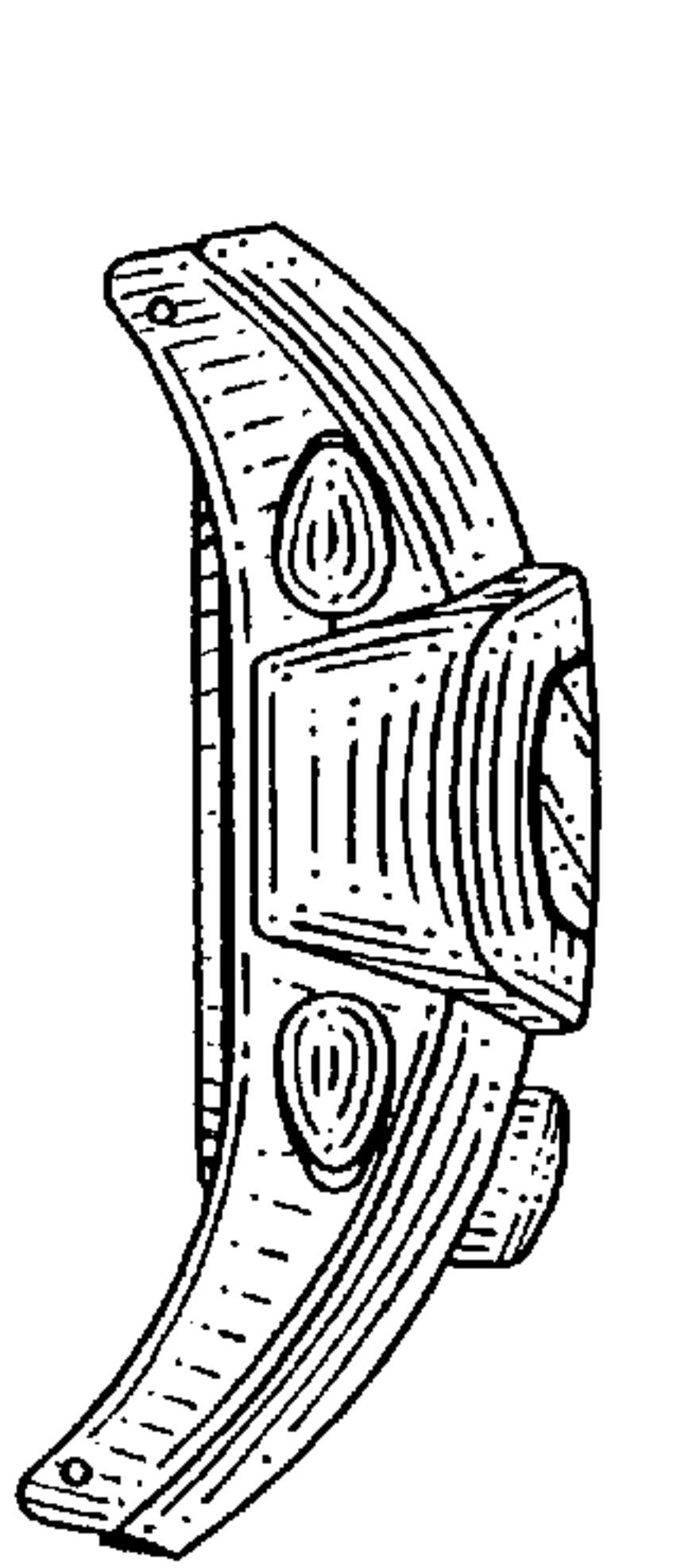

FIG. 47

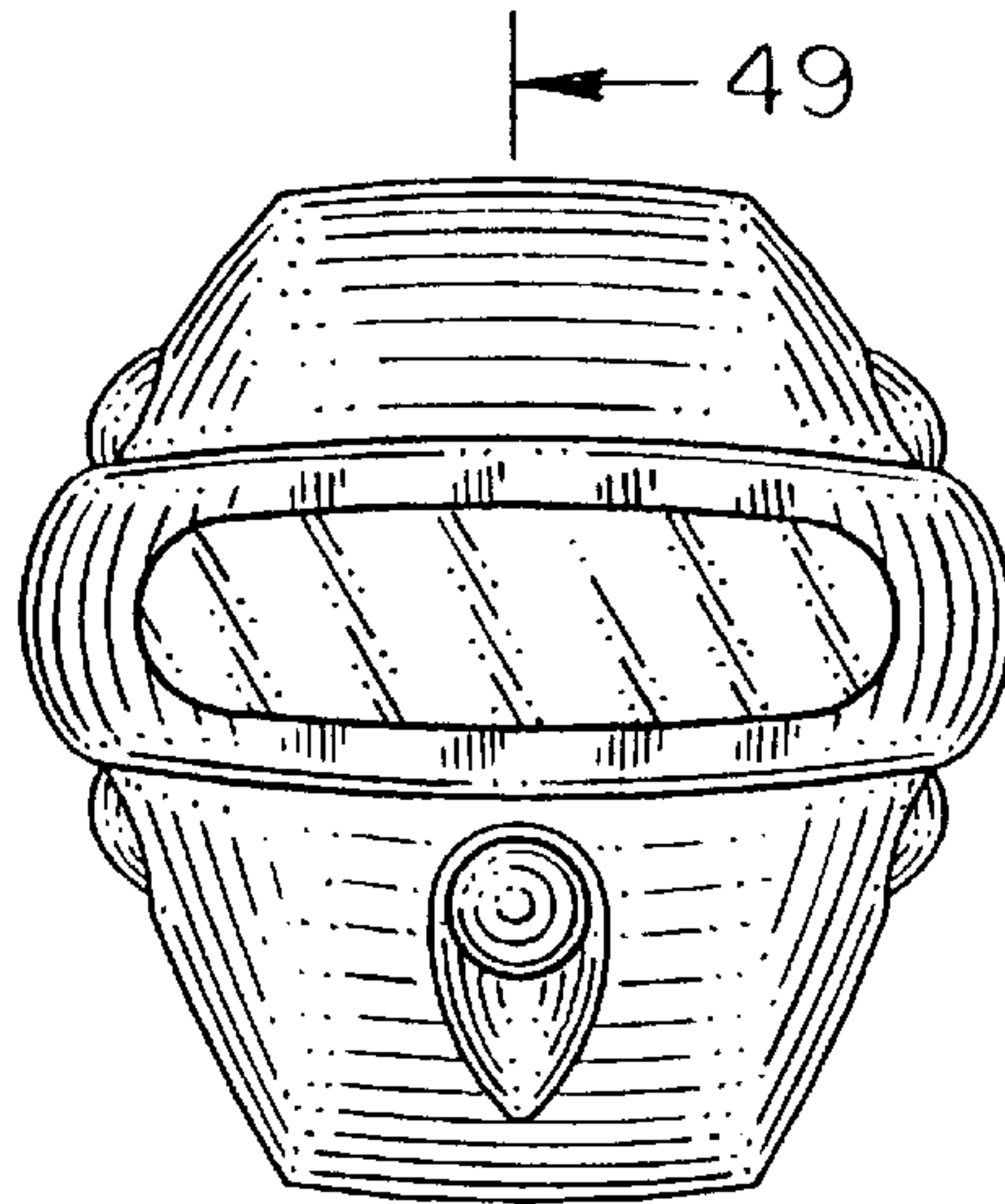

FIG. 43

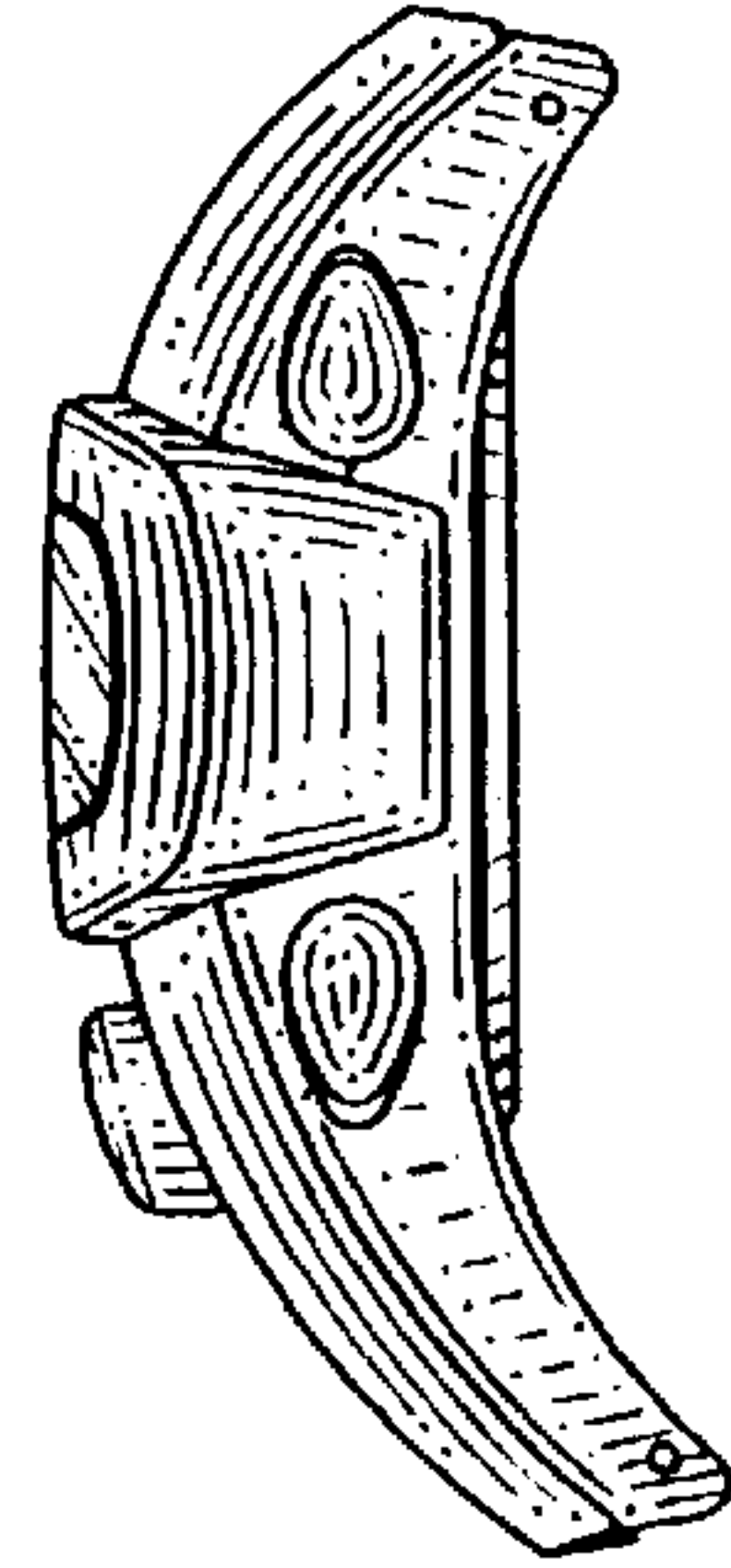

FIG. 48

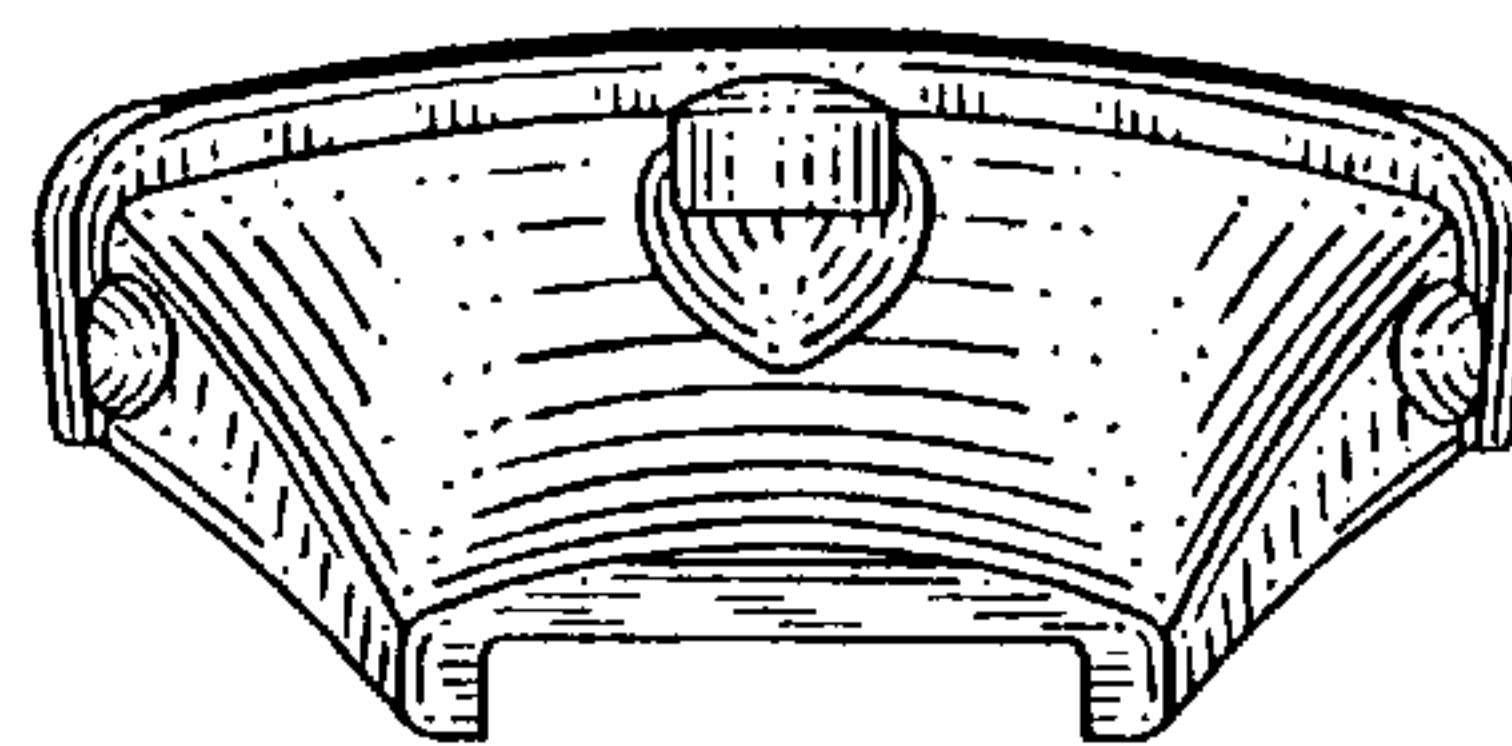

FIG. 46

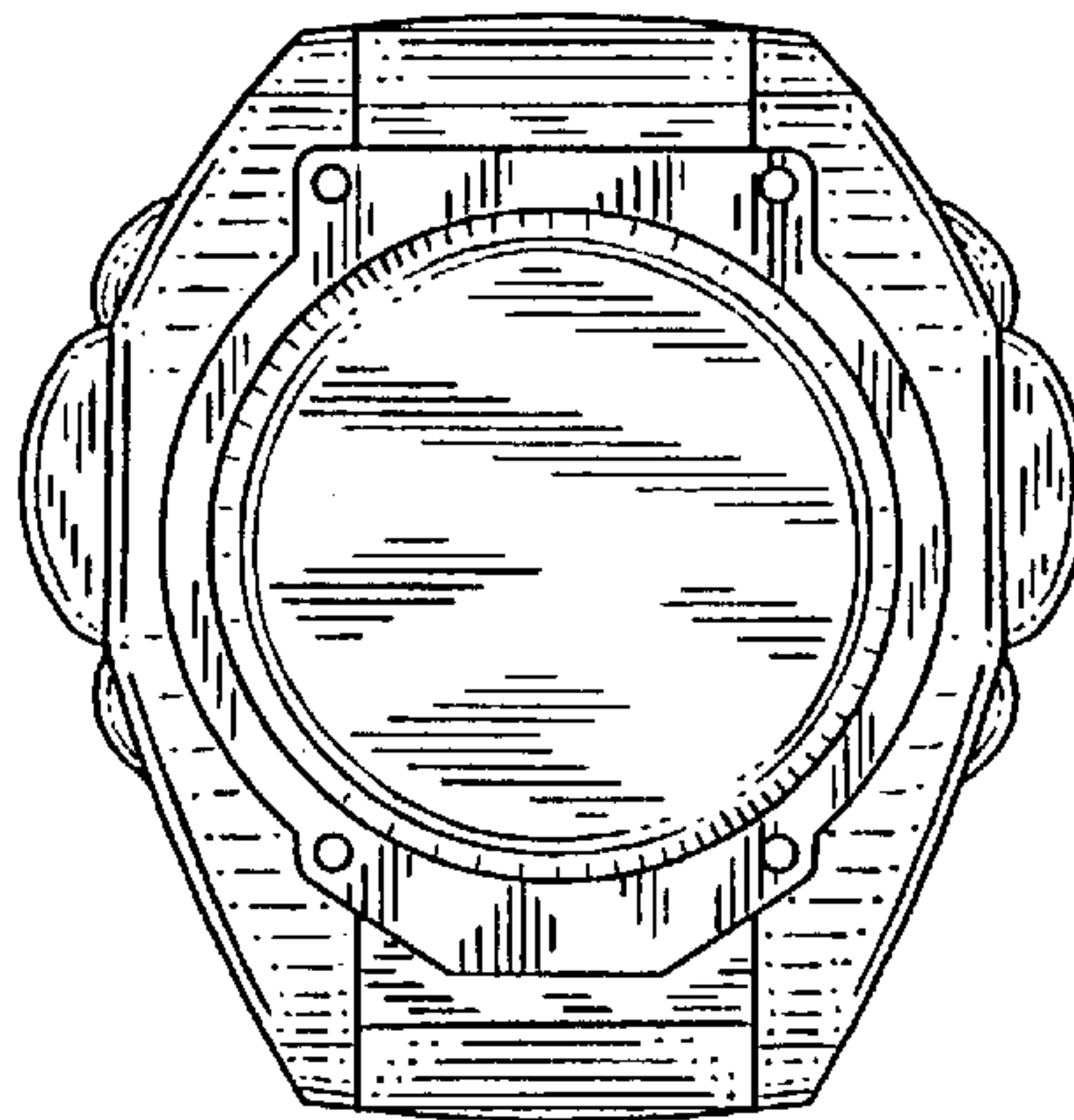

FIG. 44

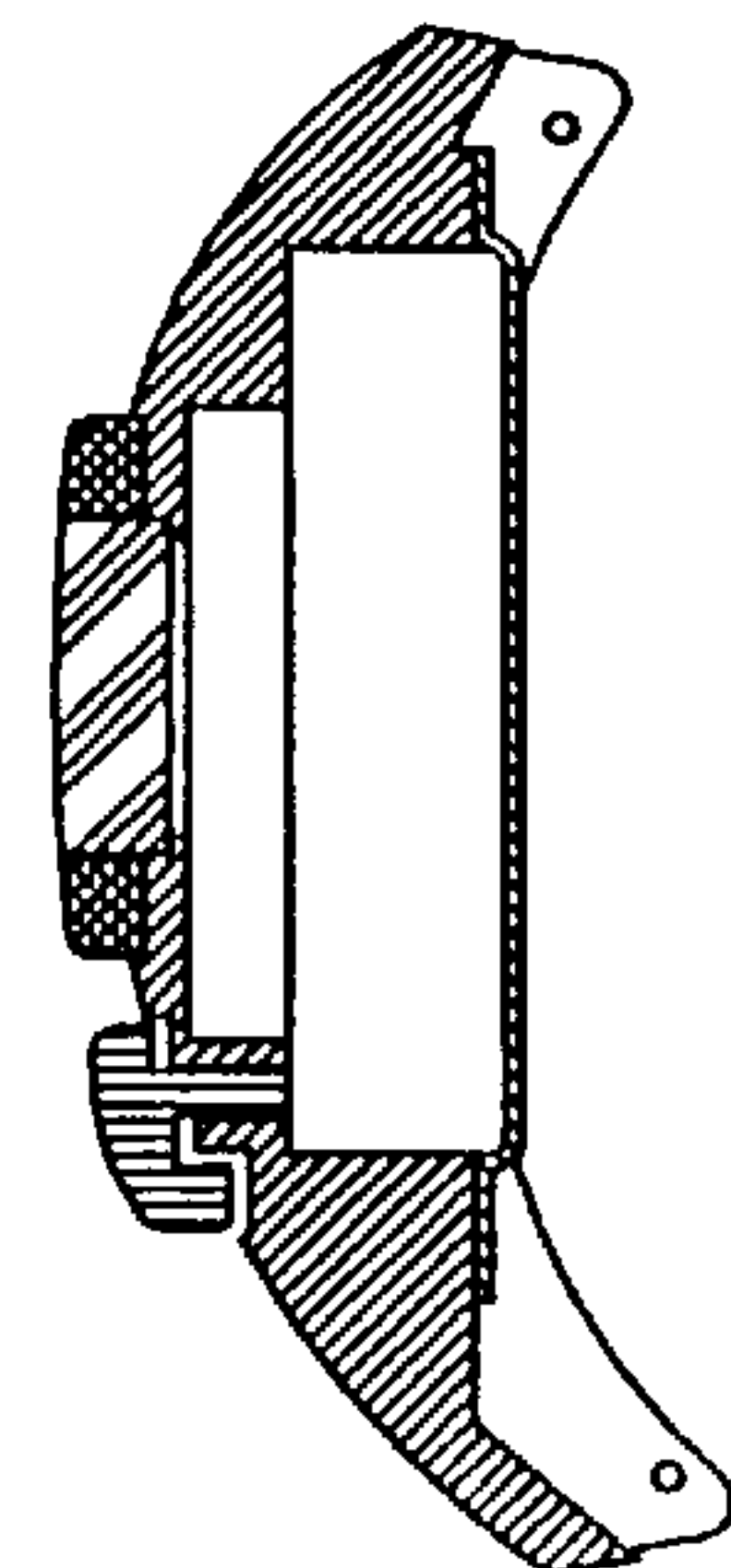

FIG. 49