



US00D407316S

United States Patent [19]
Zaksenberg

[11] **Patent Number: Des. 407,316**

[45] **Date of Patent: **Mar. 30, 1999**

[54] **CONTAINER**

[75] Inventor: **Issac Zaksenberg**, Scotch Plains, N.J.

[73] Assignee: **Colgate-Palmolive Company**, New York, N.Y.

[**] Term: **14 Years**

[21] Appl. No.: **91,757**

[22] Filed: **Aug. 5, 1998**

[51] **LOC (6) Cl.** **09-01**

[52] **U.S. Cl.** **D9/523; D9/529; D9/543; D9/552**

[58] **Field of Search** D9/523, 529, 526, D9/543, 552, 565, 537, 540, 530; 215/382, 383, 384; 222/206, 210, 212, 213, 215

[56] **References Cited**

U.S. PATENT DOCUMENTS

D. 209,474	12/1967	Stern	D9/543
D. 256,431	8/1980	Campbell et al.	D9/523
D. 265,887	8/1982	Weckman	D9/523
D. 271,856	12/1983	Suhajda et al.	D9/523
D. 287,227	12/1986	Turnbull	D9/523
D. 302,385	7/1989	Weiler	D9/529

D. 387,673 12/1997 Crawford D9/523

Primary Examiner—Lucy Lieberman
Attorney, Agent, or Firm—Michael McGreal

[57] **CLAIM**

The ornamental design for a container, as shown and described.

DESCRIPTION

FIG. 1 is a perspective view of my design of a container;
FIG. 2 is a front elevation view thereof;
FIG. 3 is a rear elevation view thereof;
FIG. 4 is a right side elevation view thereof;
FIG. 5 is a left side elevation view thereof;
FIG. 6 is a top plan view thereof;
FIG. 7 is a bottom plan view thereof;
FIG. 8 is a perspective view of my design for a container with the lid open;
FIG. 9 is a front elevation view thereof;
FIG. 10 is a rear elevation view thereof;
FIG. 11 is a right side elevation view thereof;
FIG. 12 is a left side elevation view thereof;
FIG. 13 is a top plan view thereof; and,
FIG. 14 is a bottom plan view thereof.

1 Claim, 4 Drawing Sheets

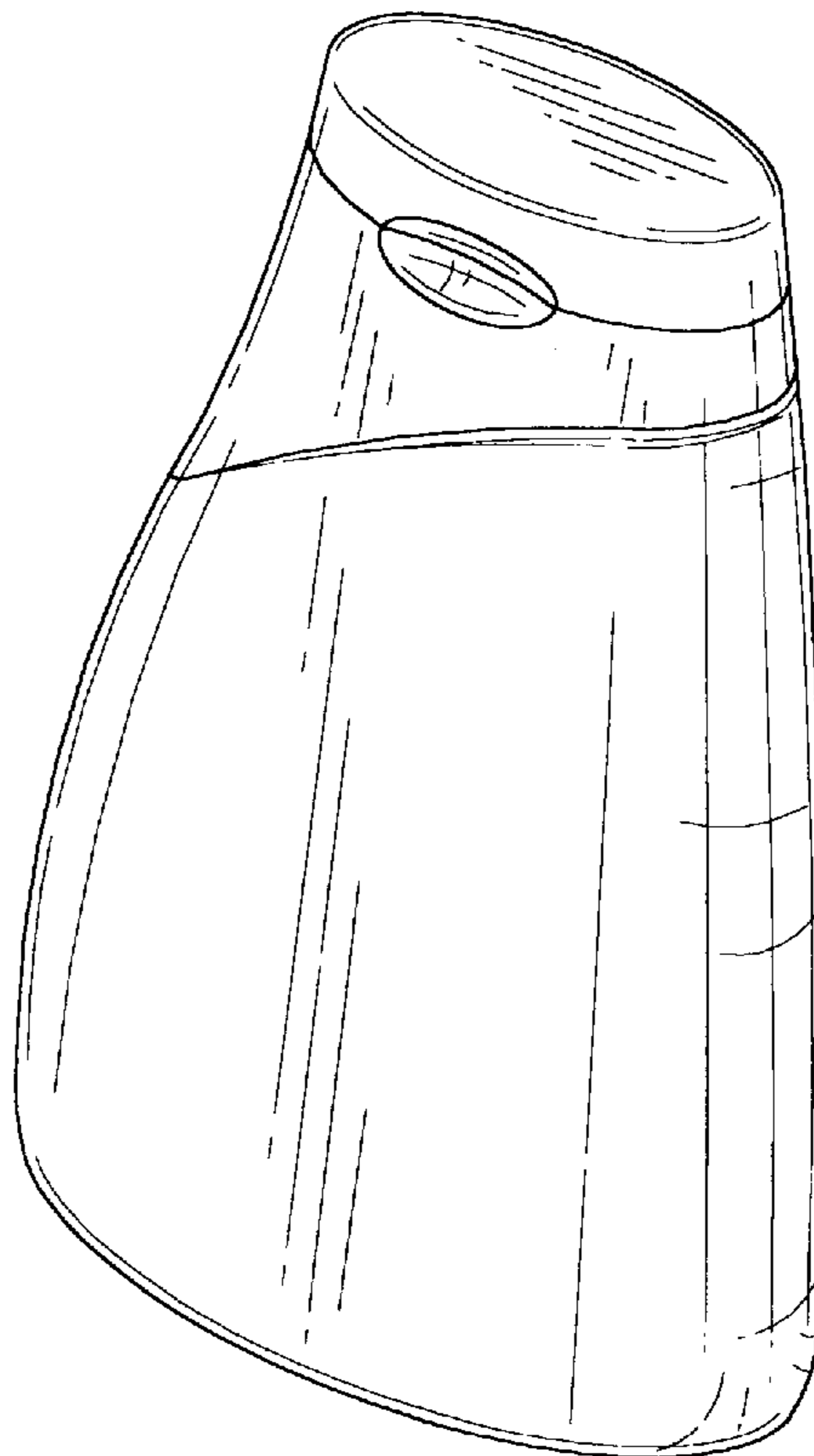

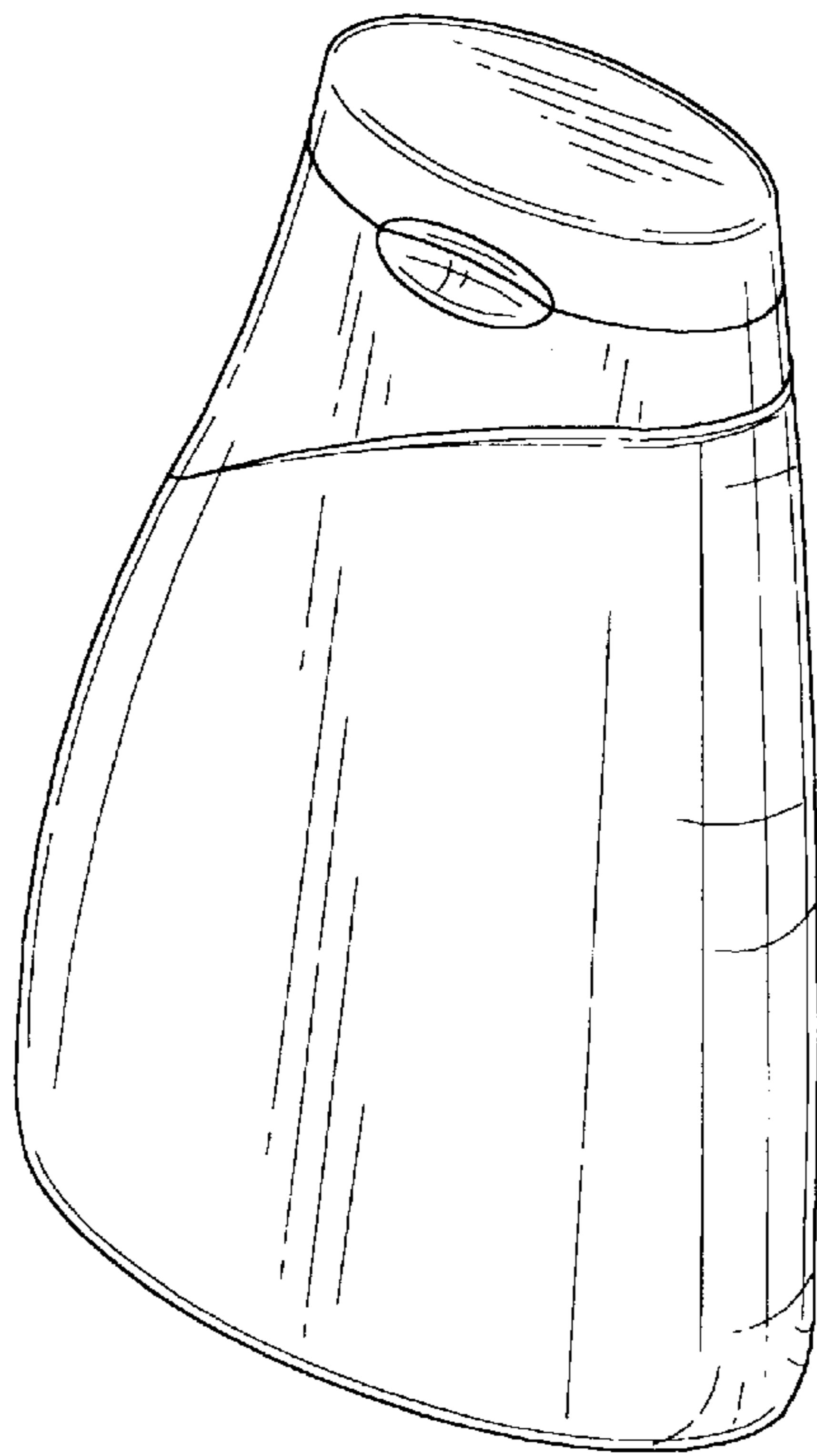

FIG. 1

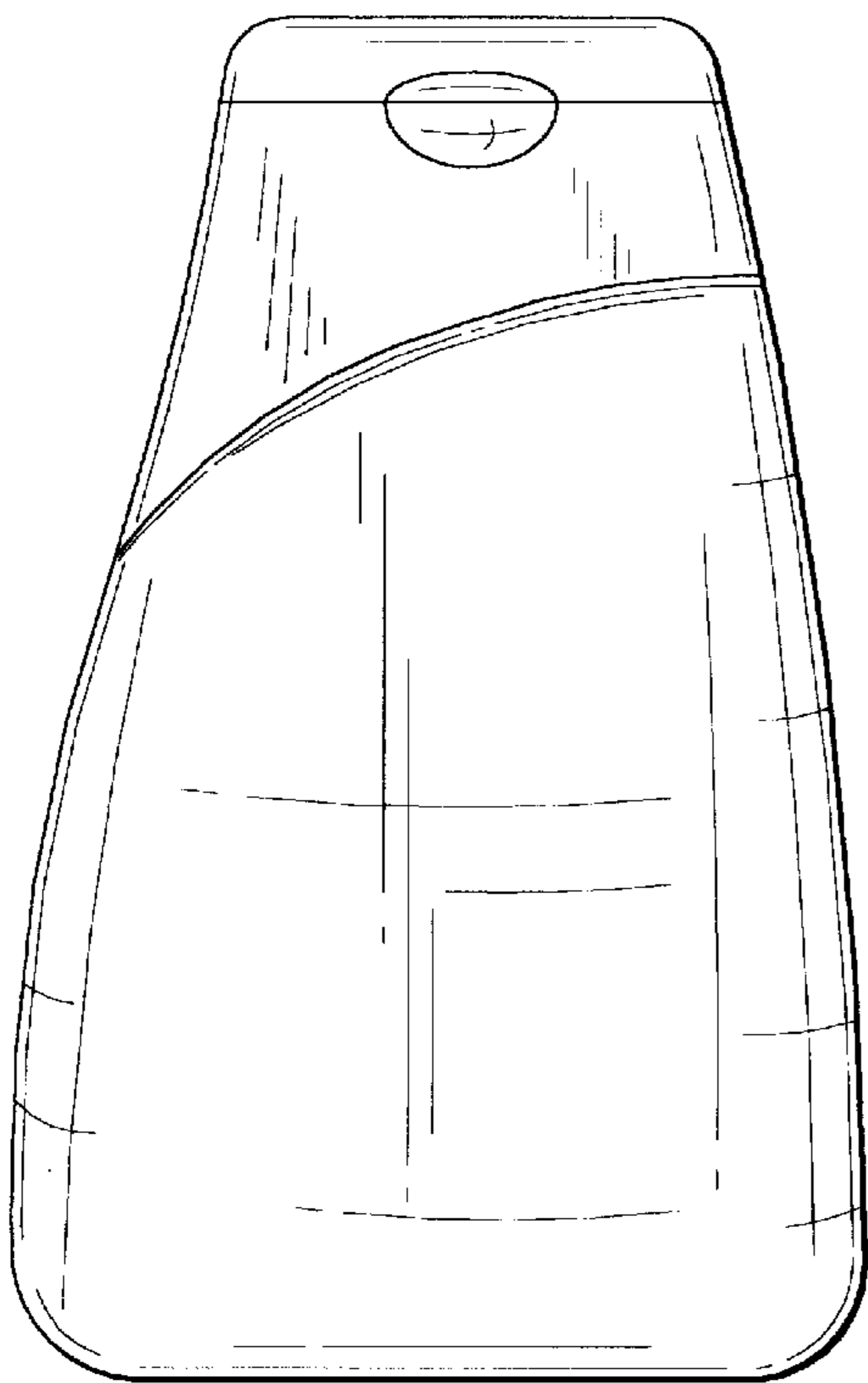

FIG. 2

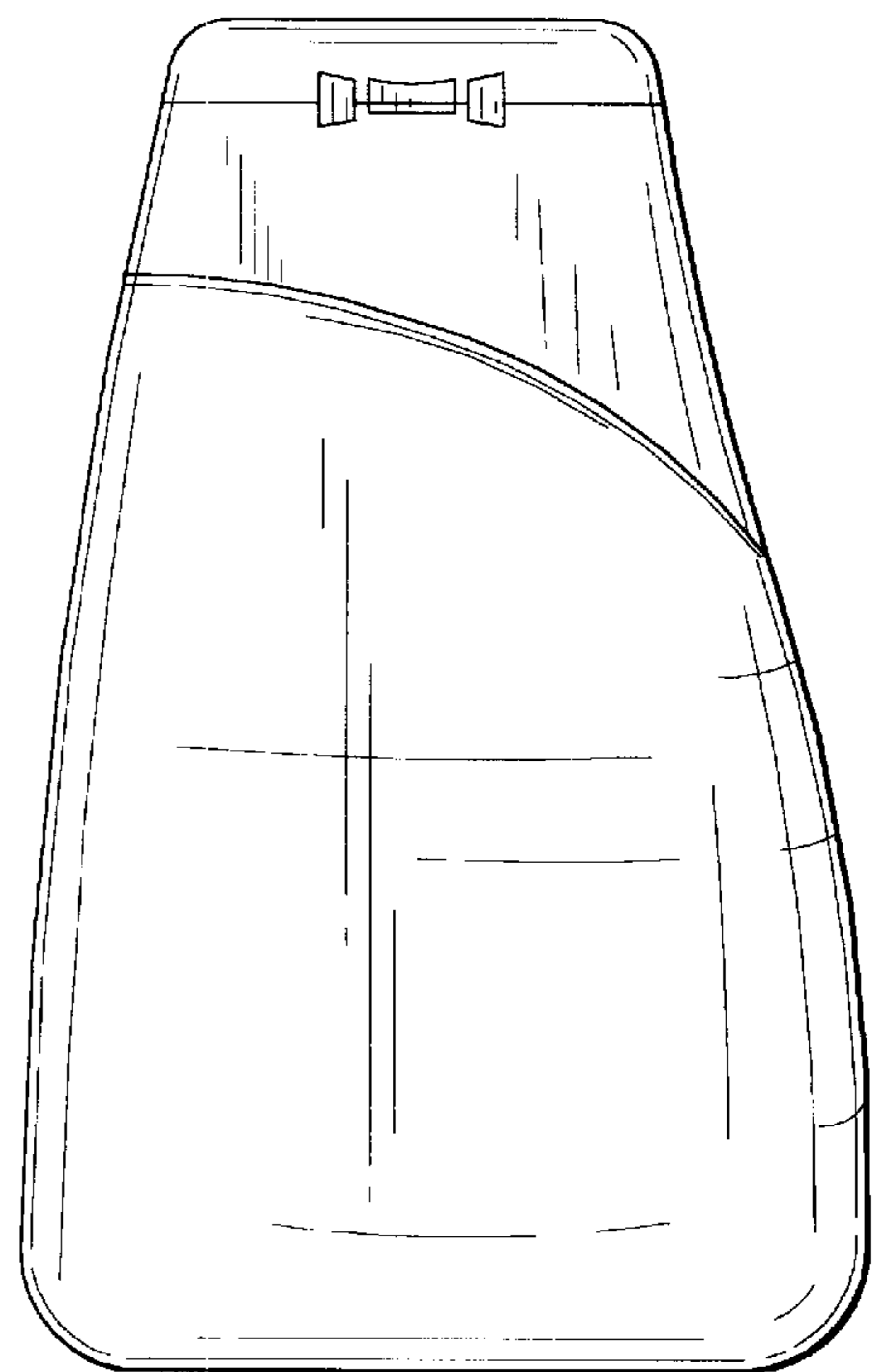

FIG. 3

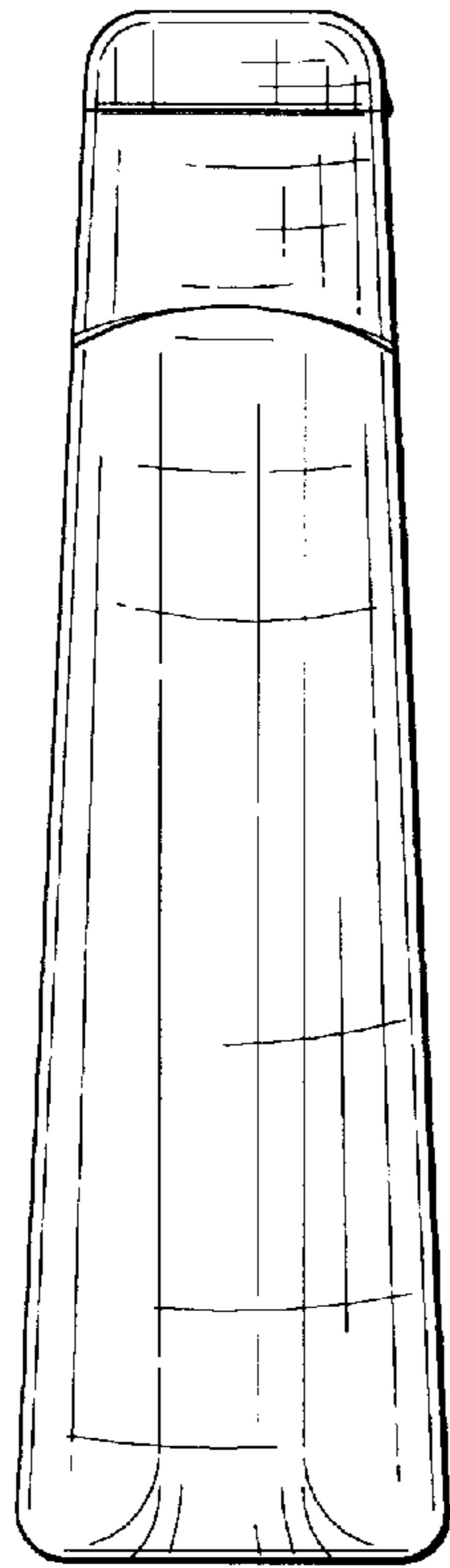

FIG. 4

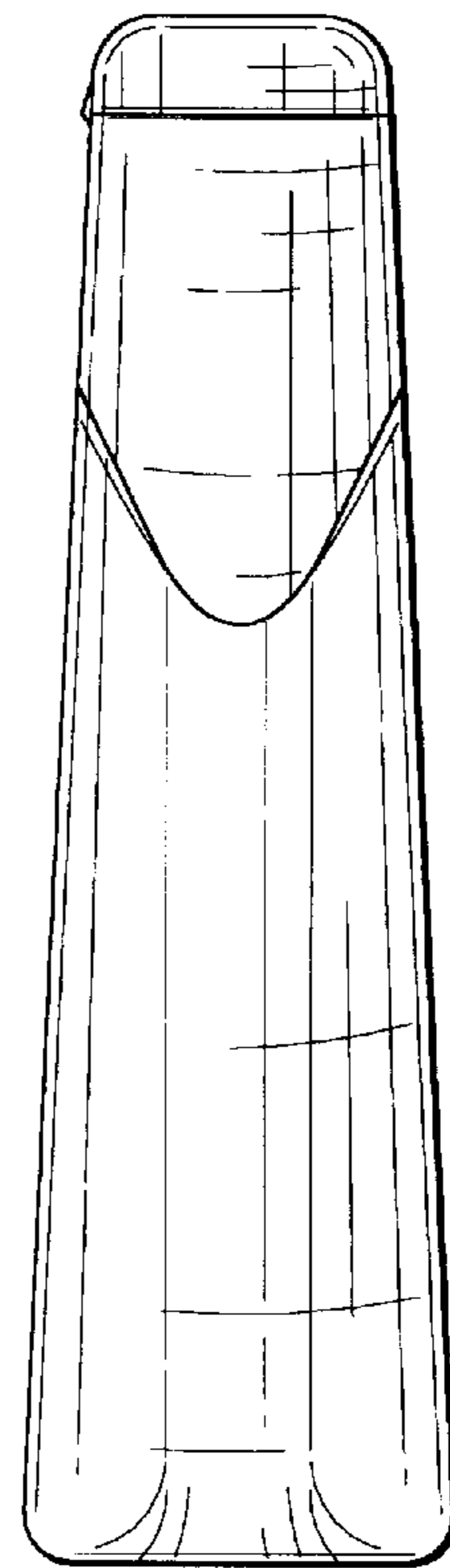

FIG. 5

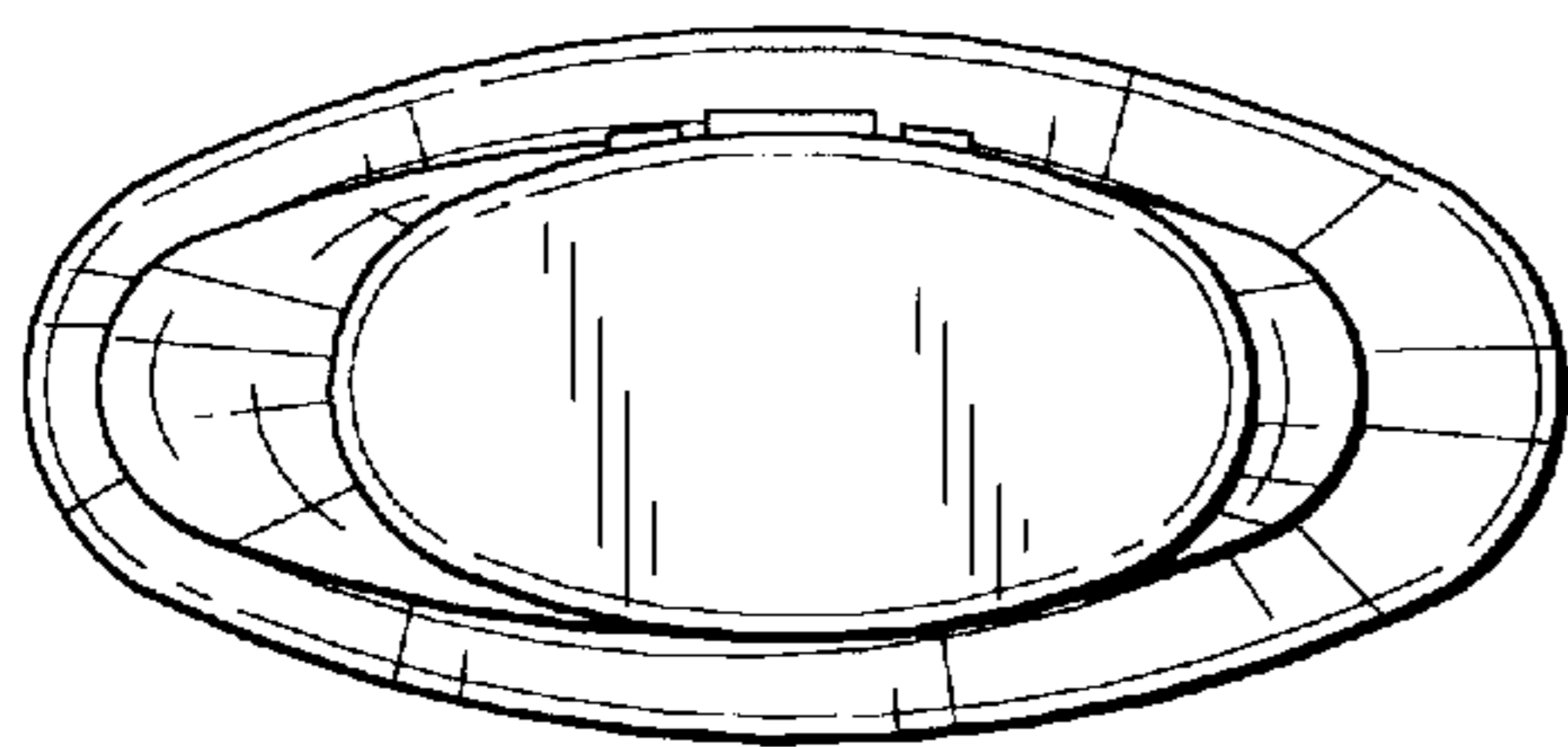

FIG. 6

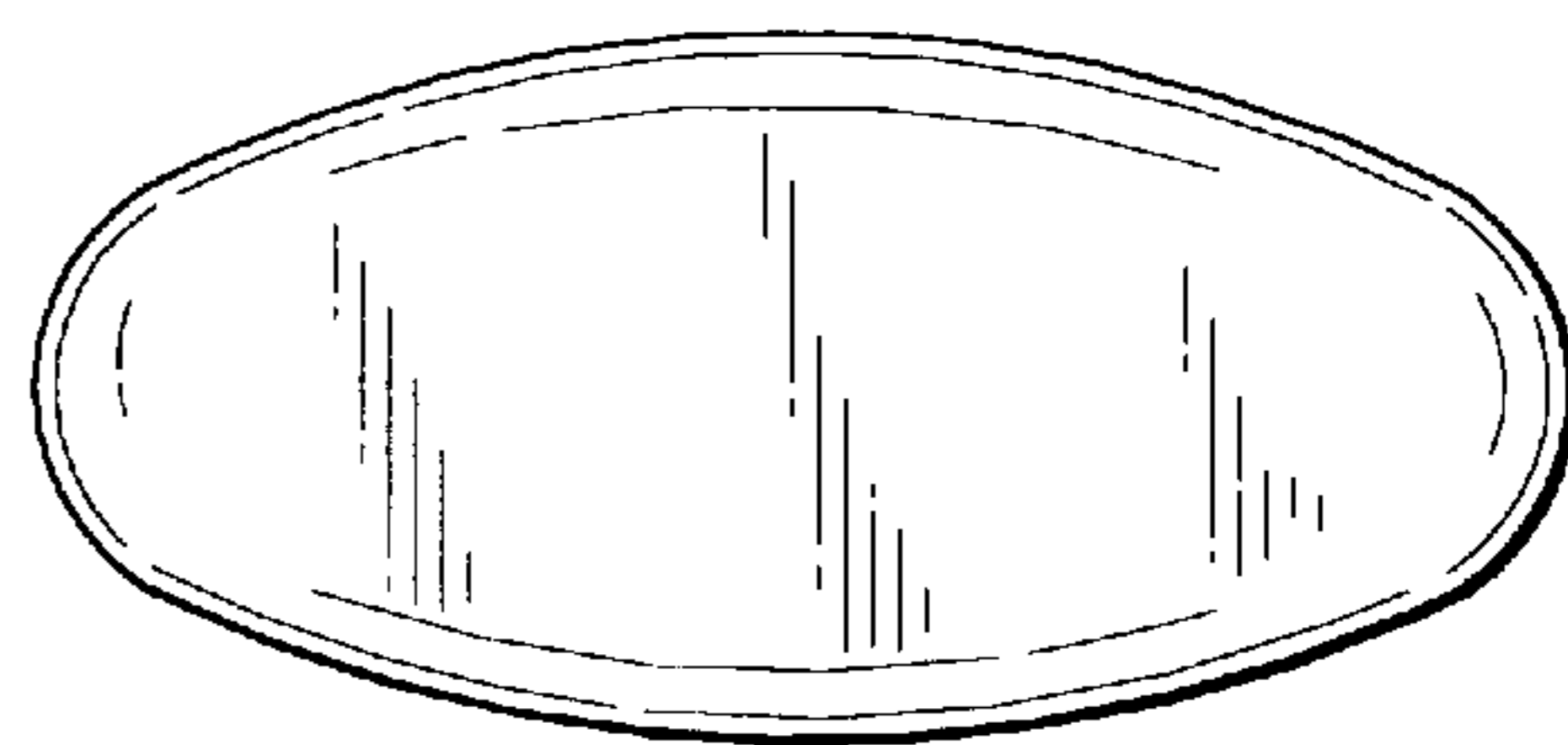

FIG. 7

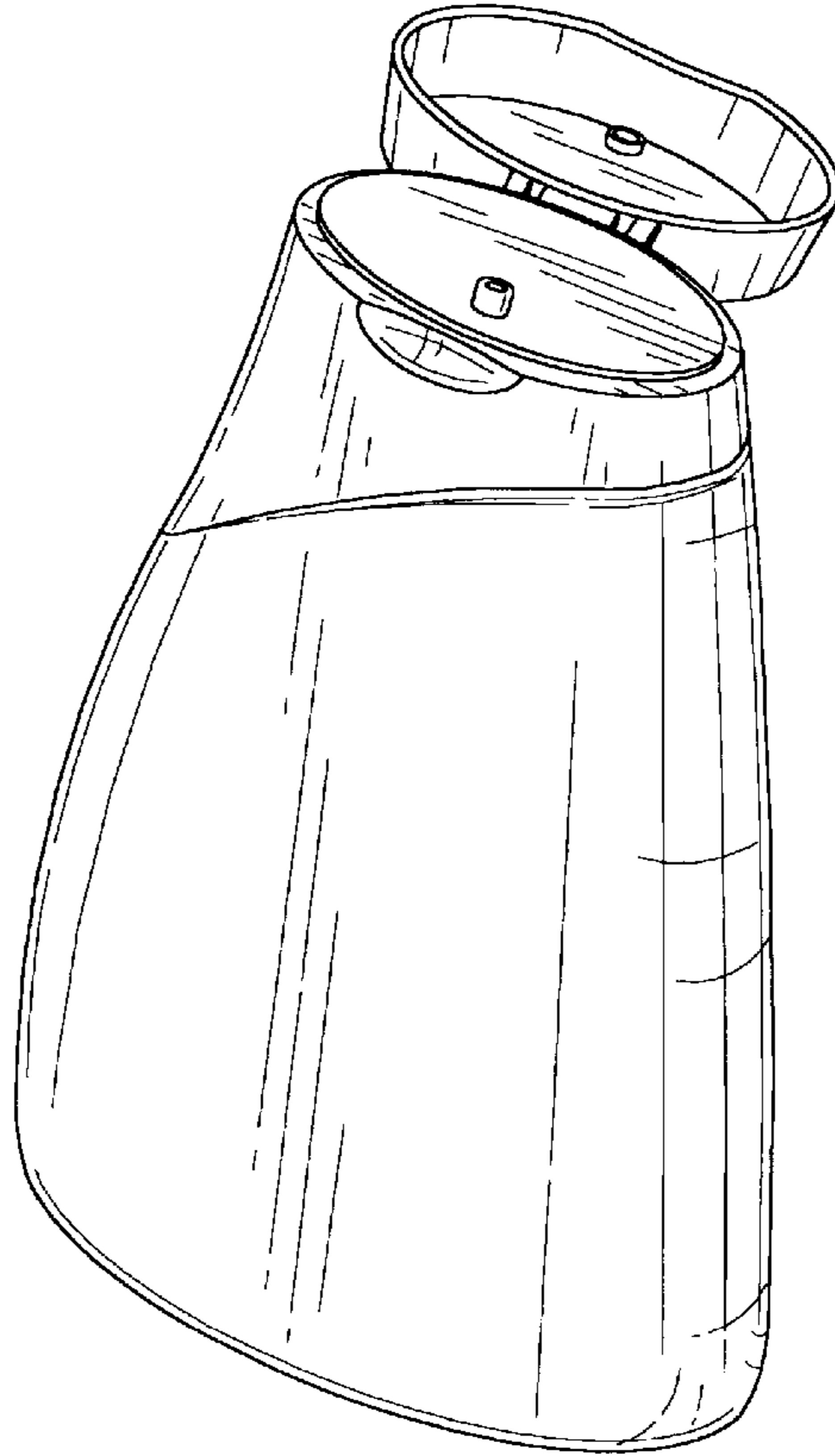

FIG. 8

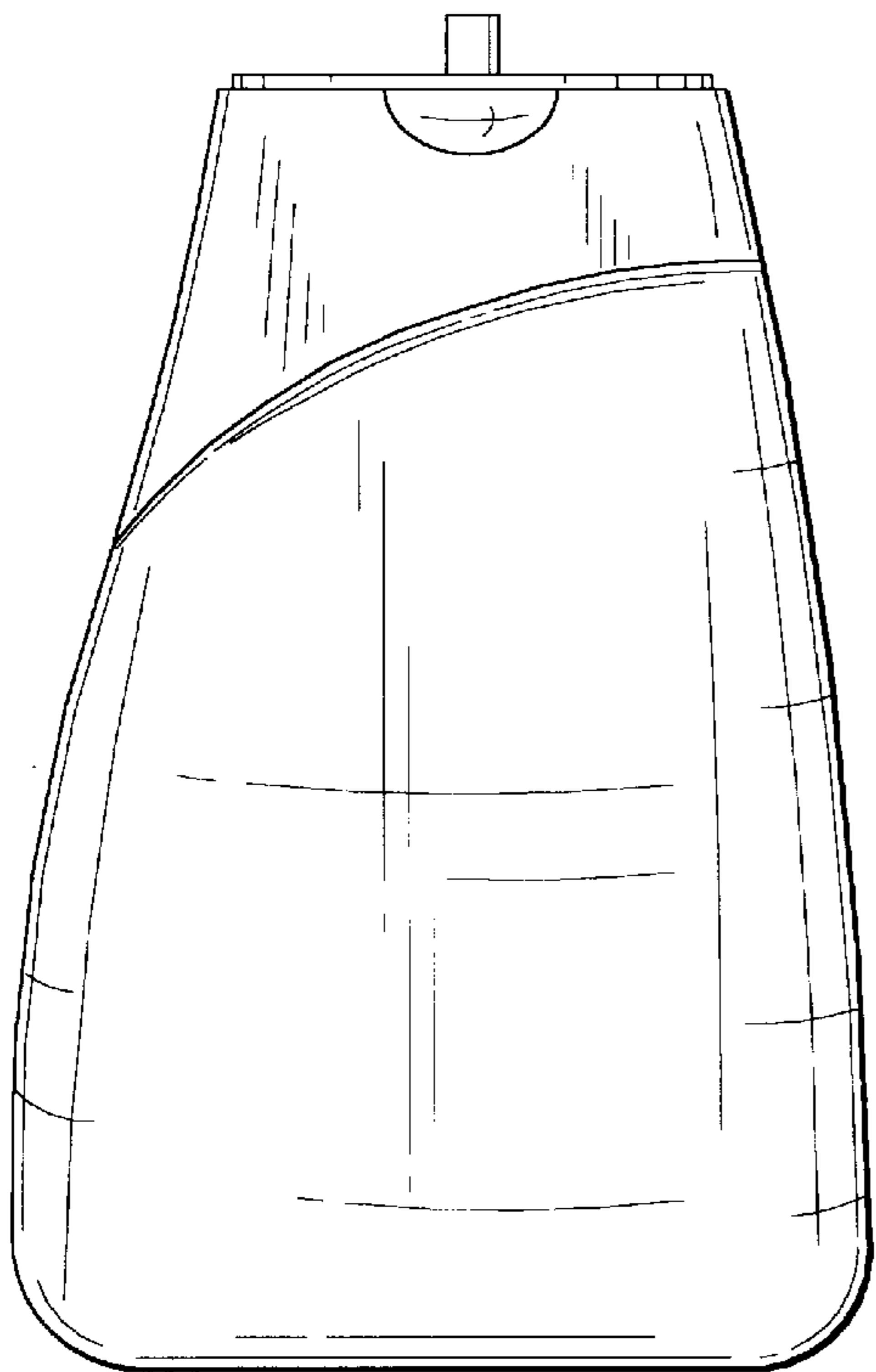

FIG. 9

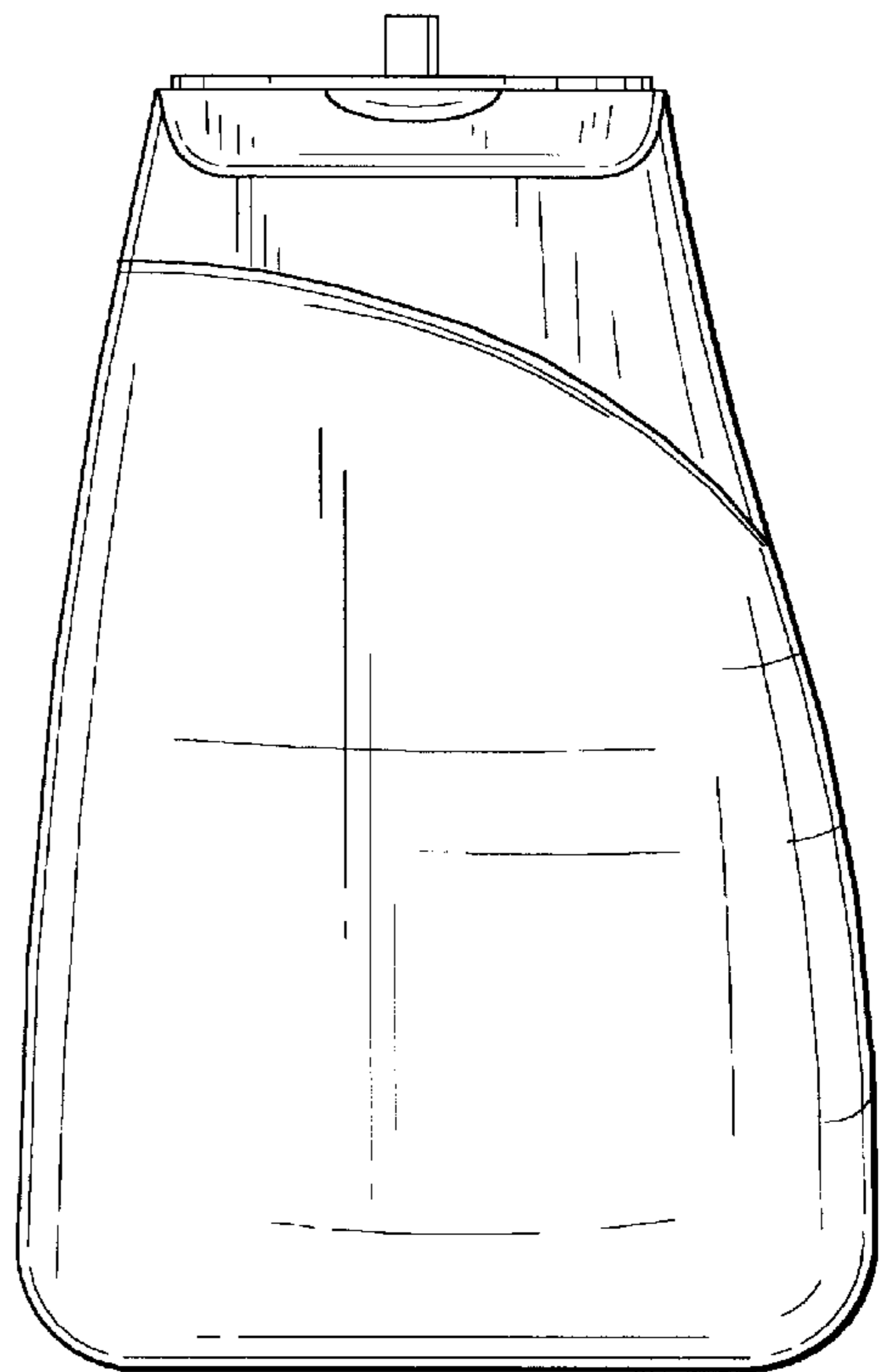

FIG. 10

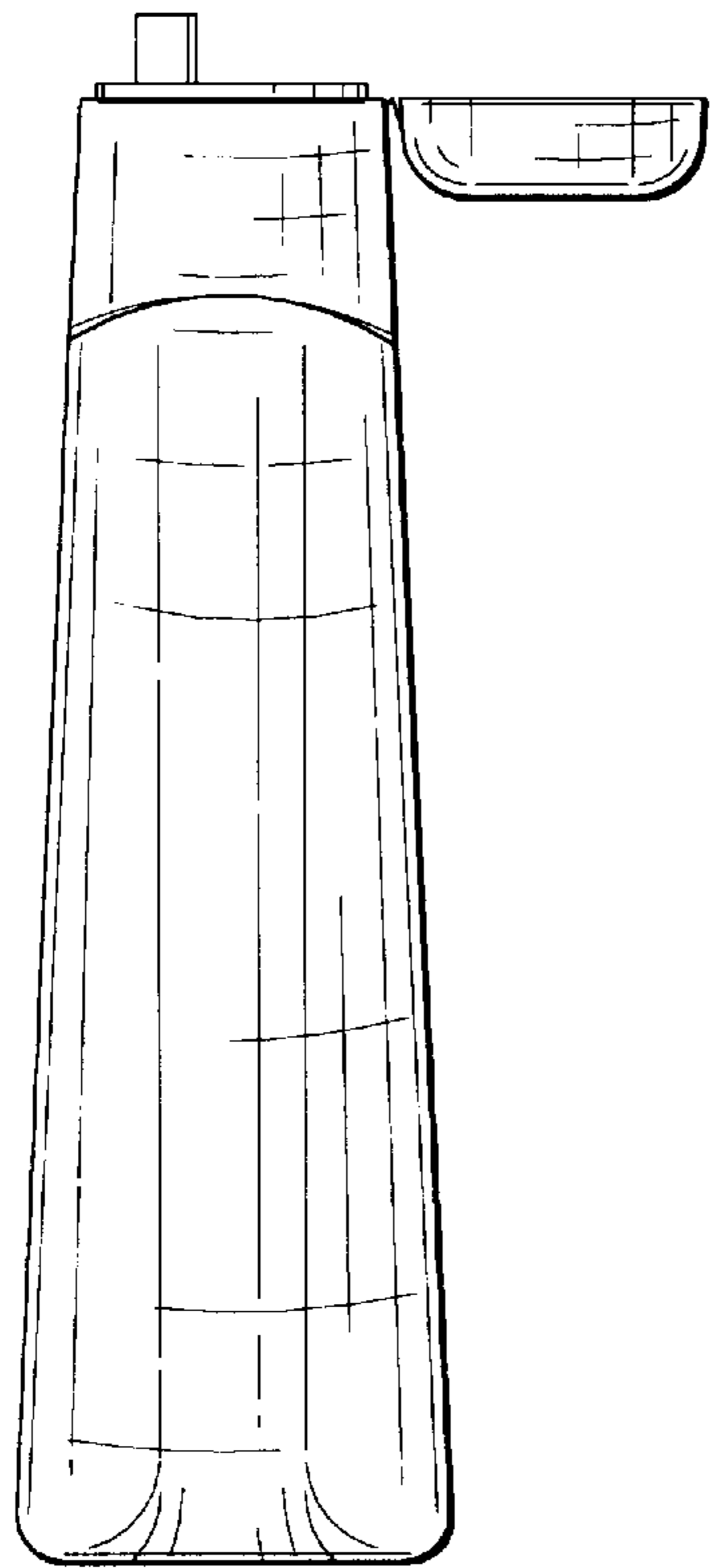

FIG. 11

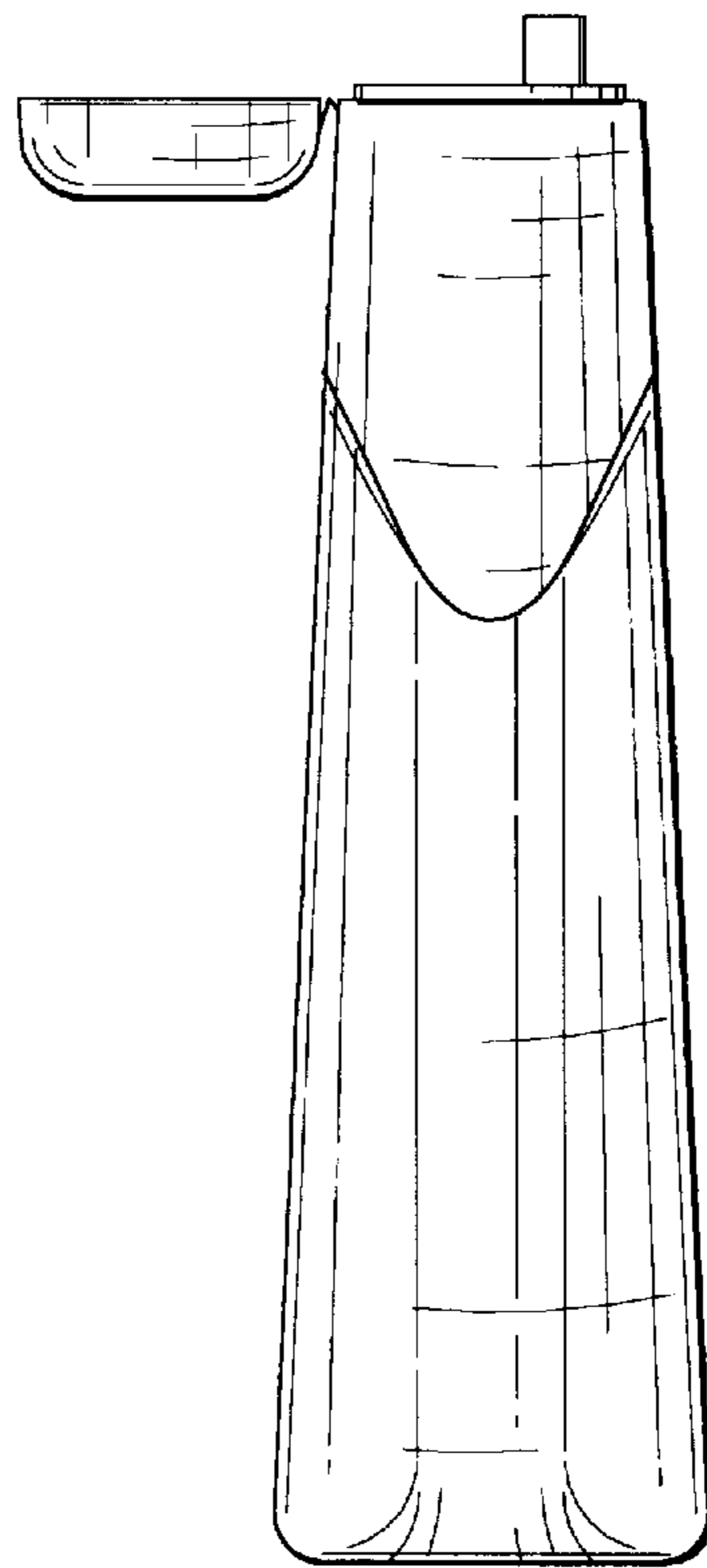

FIG. 12

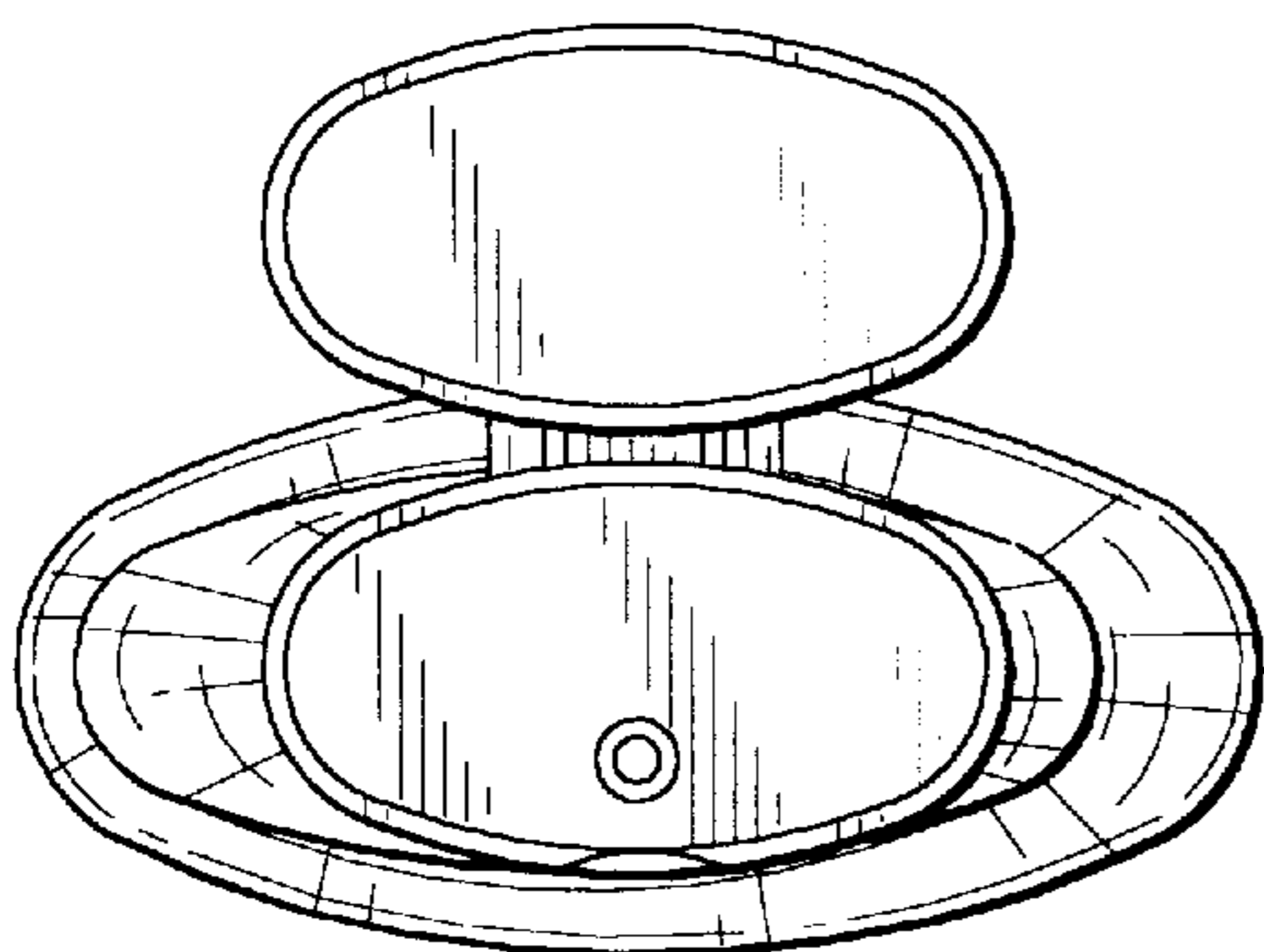

FIG. 13

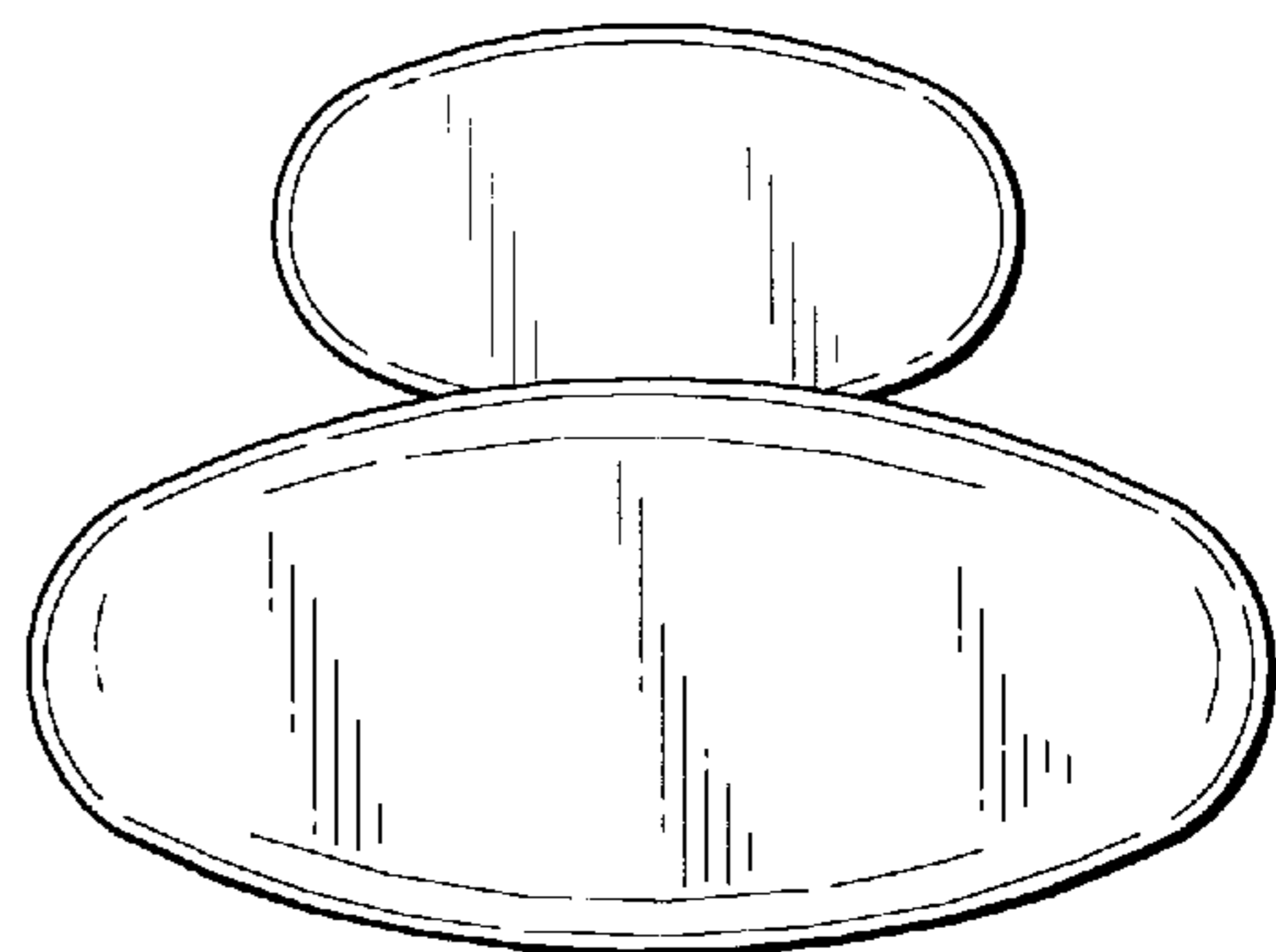

FIG. 14