



US00D407226S

United States Patent [19]
Cardenas

[11] **Patent Number: Des. 407,226**

[45] **Date of Patent: **Mar. 30, 1999**

[54] **COMBINED HOOK AND MULTIPLE HANGER SUPPORT**

[76] Inventor: **John Cardenas**, 339 W. Norman Ave., Arcadia, Calif. 91007

[**] Term: **14 Years**

[21] Appl. No.: **80,871**

[22] Filed: **Dec. 18, 1997**

[51] **LOC (6) Cl.** **06-08**

[52] **U.S. Cl.** **D6/328; D8/370**

[58] **Field of Search** **D3/315; D6/328; D8/367, 370; 211/113; 248/215, 339; 294/142, 143, 146, 153, 161**

[56] **References Cited**

U.S. PATENT DOCUMENTS

- D. 193,919 10/1962 Meyer et al. .
- D. 321,795 11/1991 Winston .
- D. 343,113 1/1994 Brooks .
- D. 395,555 6/1998 Ursitti .
- 2,941,672 6/1960 Lathrop .
- 5,515,981 5/1996 Gregory et al. .
- 5,584,455 12/1996 Artemi .

Primary Examiner—B. J. Bullock
Attorney, Agent, or Firm—Curtis L. Harrington

[57] **CLAIM**

The ornamental design for a combined hook and multiple hanger support, as shown and described.

DESCRIPTION

FIG. 1 is a front perspective view of the combined hook and multiple hanger support shown in grasped position and with the support loops seen in partially opened position;

FIG. 2 is a rear view thereof;

FIG. 3 is a front view thereof;

FIG. 4 is a left side view thereof;

FIG. 5 is a right side view thereof;

FIG. 6 is a top view thereof; and,

FIG. 7 is a bottom view thereof.

FIGS. 1—5 are shown broken away to indicate indeterminate length. The broken lines in FIGS. 1—3 which extend across the support represent stitching while the broken line showing of a hand and portion of an arm in FIG. 1 is for illustrative purposes only and forms no part of the claimed design.

1 Claim, 3 Drawing Sheets

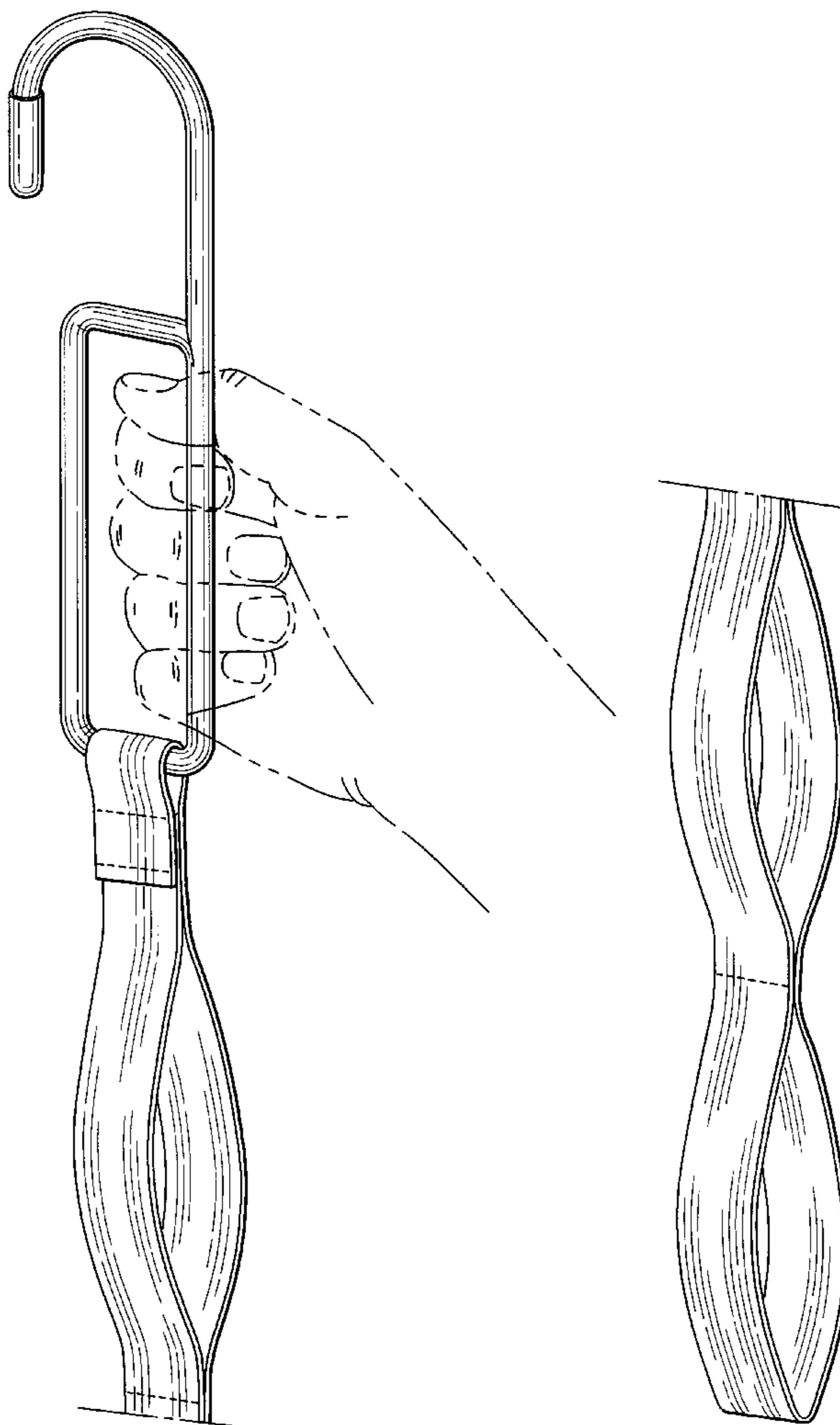

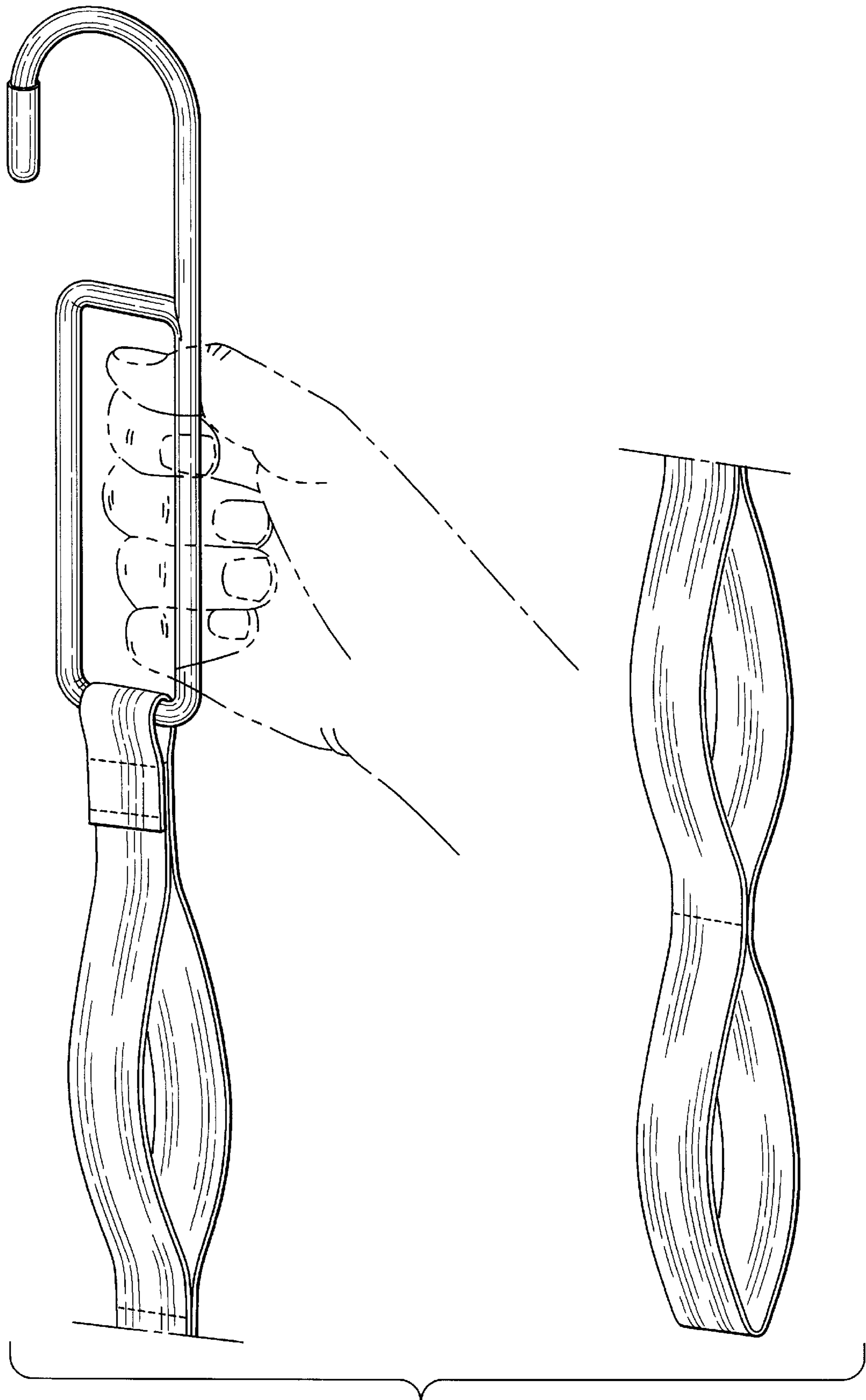

Fig. 1

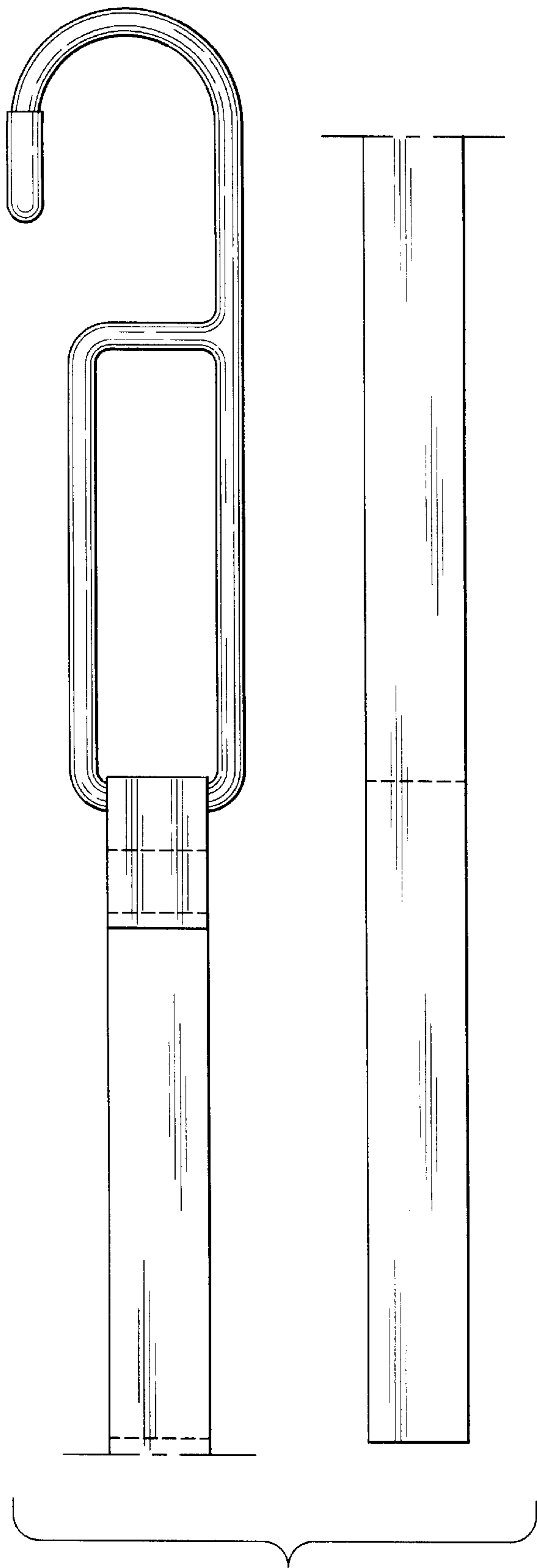

Fig. 2

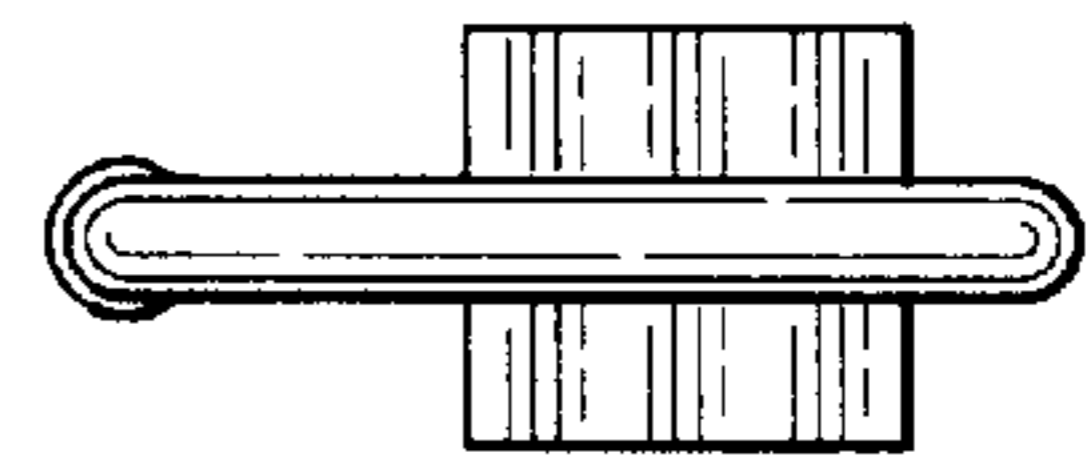

Fig. 3

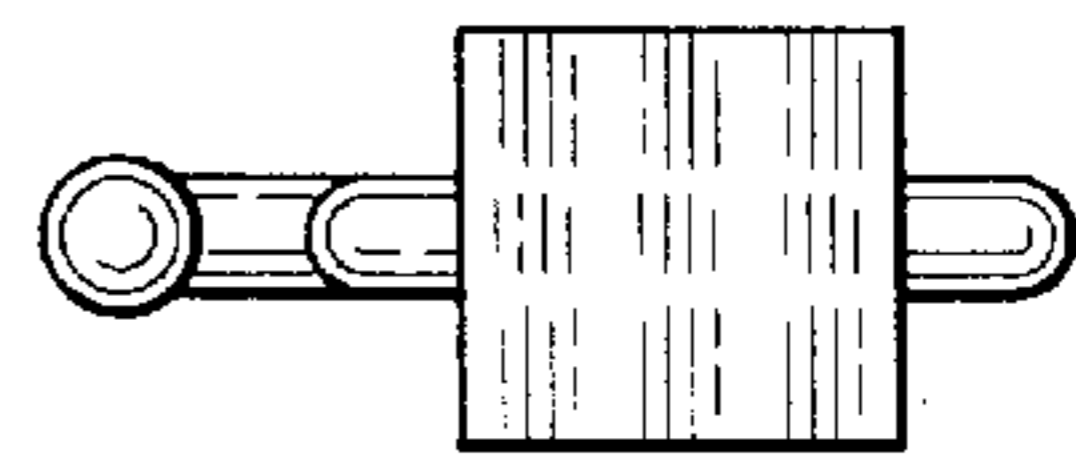

Fig. 4

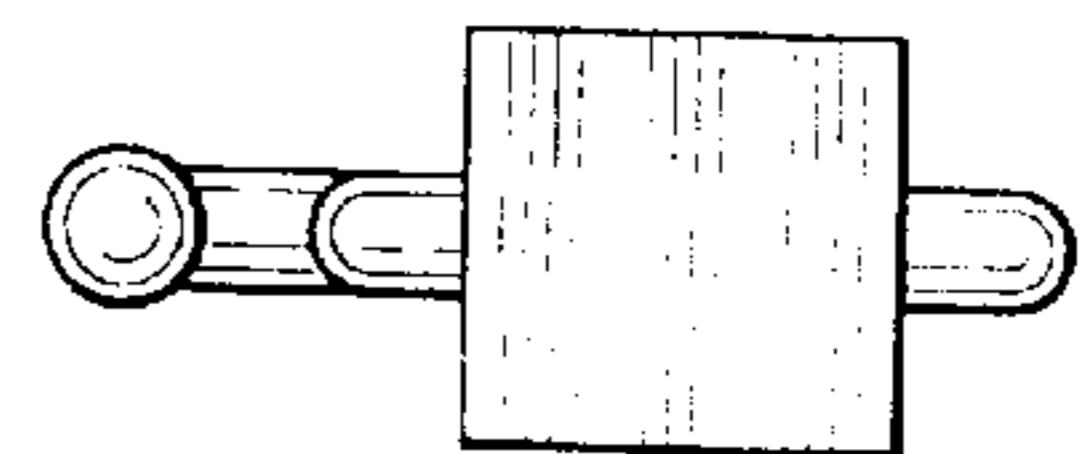

Fig. 7

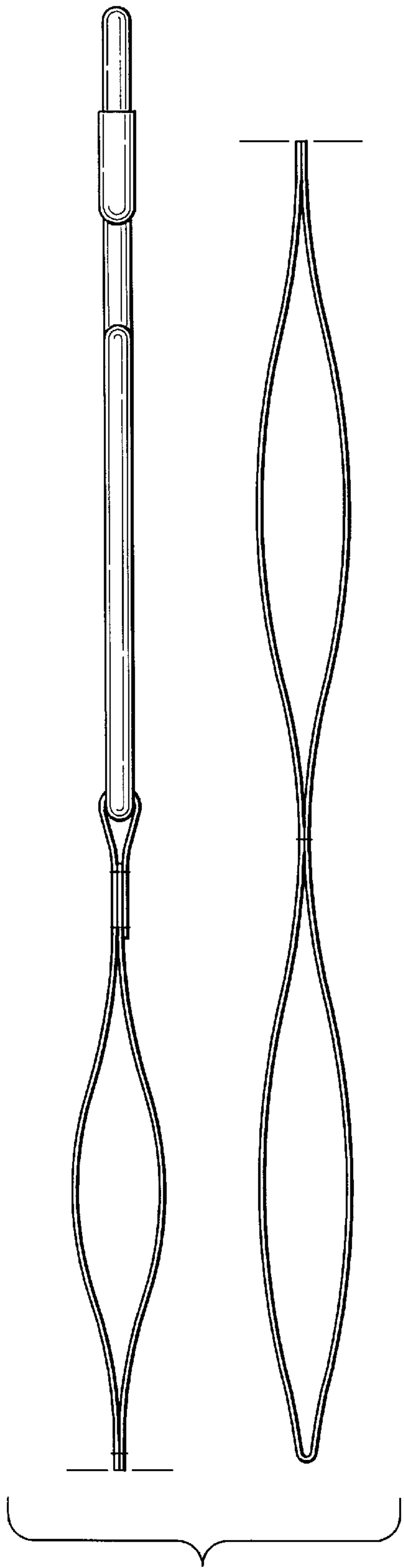

Fig. 5

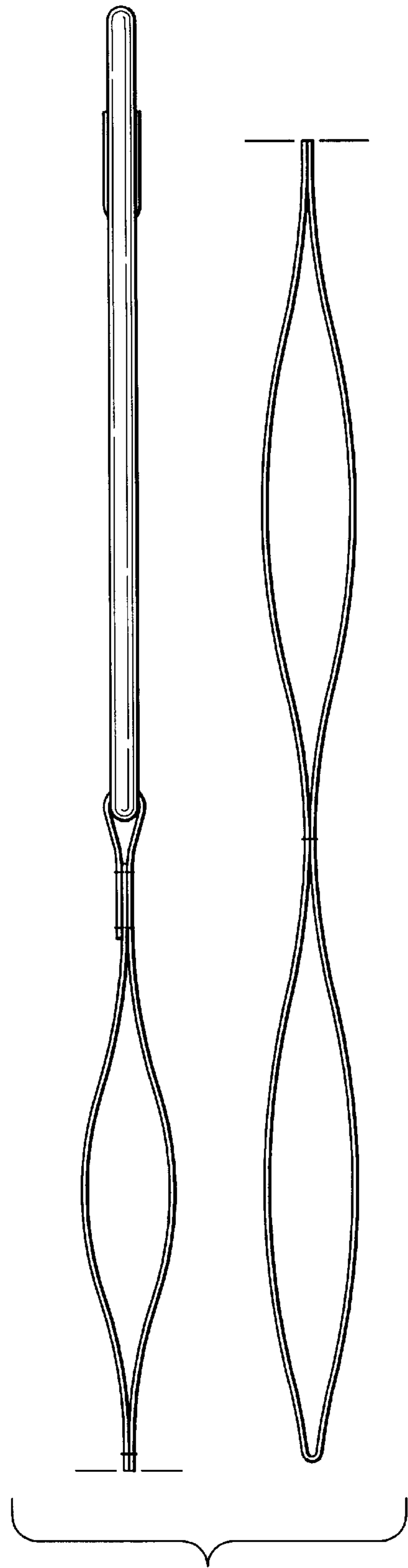

Fig. 6