



US00D407223S

# United States Patent [19] Van Gelder

[11] Patent Number: Des. 407,223

[45] Date of Patent: \*\*Mar. 30, 1999

[54] **TOOTHBRUSH HEAD**

[75] Inventor: **Maria Van Gelder**, Twickenham, Rep. of Moldova

[73] Assignee: **The Procter & Gamble Company**, Cincinnati, Ohio

[\*\*] Term: **14 Years**

[21] Appl. No.: **65,666**

[22] Filed: **Oct. 29, 1996**

[51] **LOC (6) Cl.** ..... **04-02**

[52] **U.S. Cl.** ..... **D4/104**

[58] **Field of Search** ..... D4/104-112, 132-134, D4/138; 15/159.1, 167.1, 167.2; 132/308, 309, 311; 601/139, 141

[56] **References Cited**

**U.S. PATENT DOCUMENTS**

D. 116,838	9/1939	Cave	.....	D4/104
D. 346,697	5/1994	O'Conke	.....	D4/104
2,443,297	6/1948	Bressler	.....	15/167.1
3,188,672	6/1965	Gary	.....	15/167.1
5,398,369	3/1995	Heinzelman et al.	.....	15/167.1

*Primary Examiner*—Alan P. Douglas  
*Assistant Examiner*—Lavone D. Tabor  
*Attorney, Agent, or Firm*—Jack L. Oney, Jr.

[57] **CLAIM**

The ornamental design for a toothbrush head, as shown and described.

**DESCRIPTION**

FIG. 1 is a perspective view of a toothbrush head, embodying my new design;

FIG. 2 is a side elevational view thereof; the opposite side elevational view thereof being a mirror image;

FIG. 3 is a top view thereof;

FIG. 4 is a bottom view thereof;

FIG. 5 is a front view thereof;

FIG. 6 is a back view thereof;

FIG. 7 is a perspective view of an alternative embodiment of my toothbrush head;

FIG. 8 is a side elevational view thereof, the opposite side elevational view thereof being a mirror image;

FIG. 9 is a top view thereof;

FIG. 10 is a bottom view thereof;

FIG. 11 is a front view thereof;

FIG. 12 is a back view thereof;

FIG. 13 is a perspective view of an alternative embodiment of my toothbrush head;

FIG. 14 is a side elevational view thereof, the opposite side elevational view thereof being a mirror image;

FIG. 15 is a top view thereof;

FIG. 16 is a bottom thereof;

FIG. 17 is a front view thereof; and,

FIG. 18 is a back view thereof.

The broken lines shown in the figures are for illustrative purposes only, and form no part of the claimed invention.

**1 Claim, 6 Drawing Sheets**

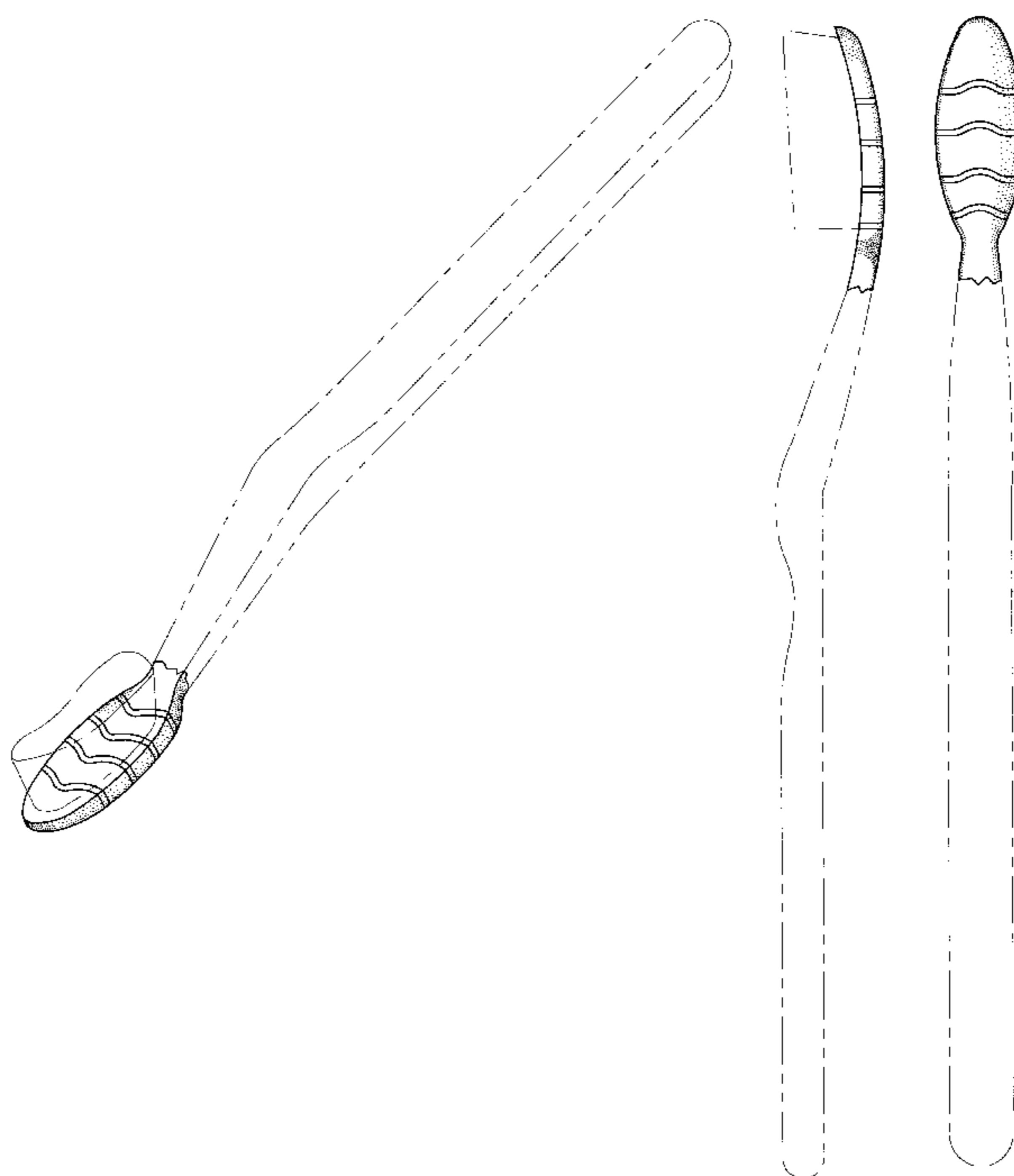

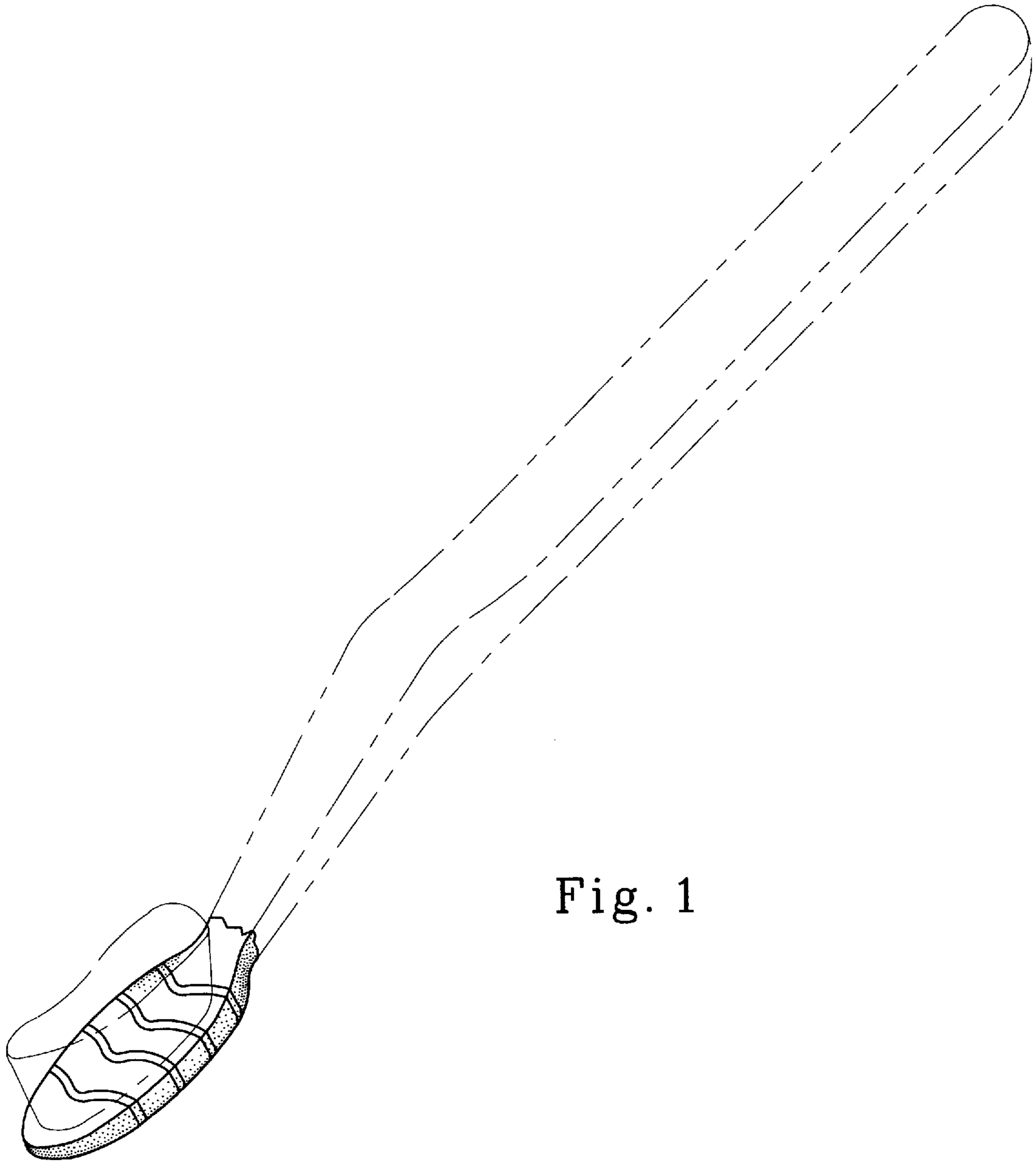

Fig. 1

Fig. 2

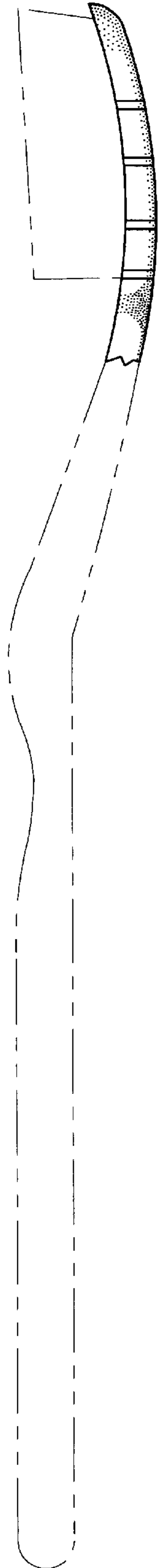

Fig. 3

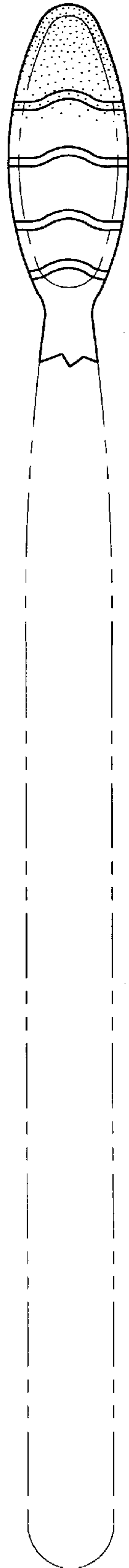

Fig. 4

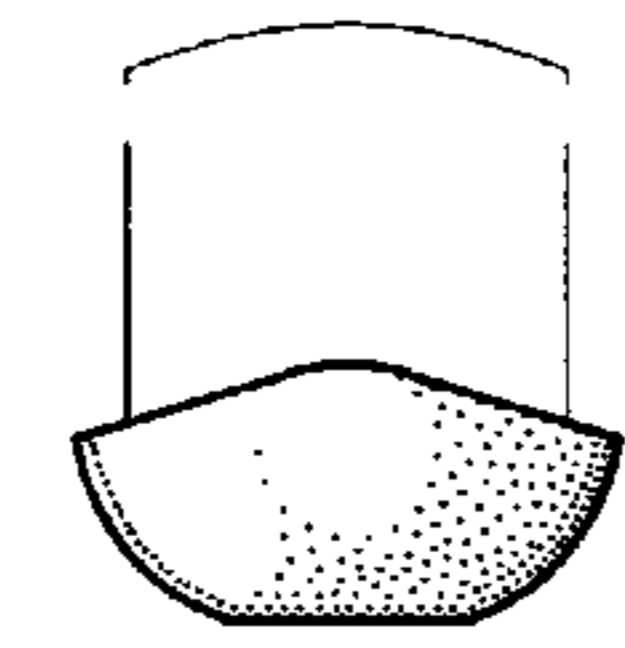

Fig. 5

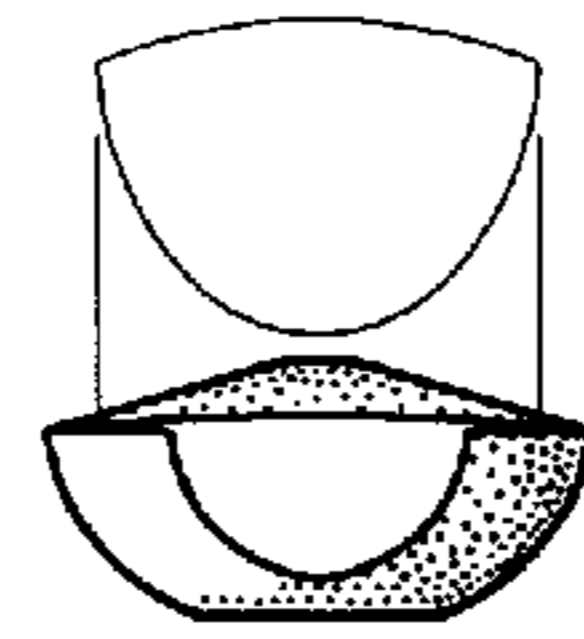

Fig. 6

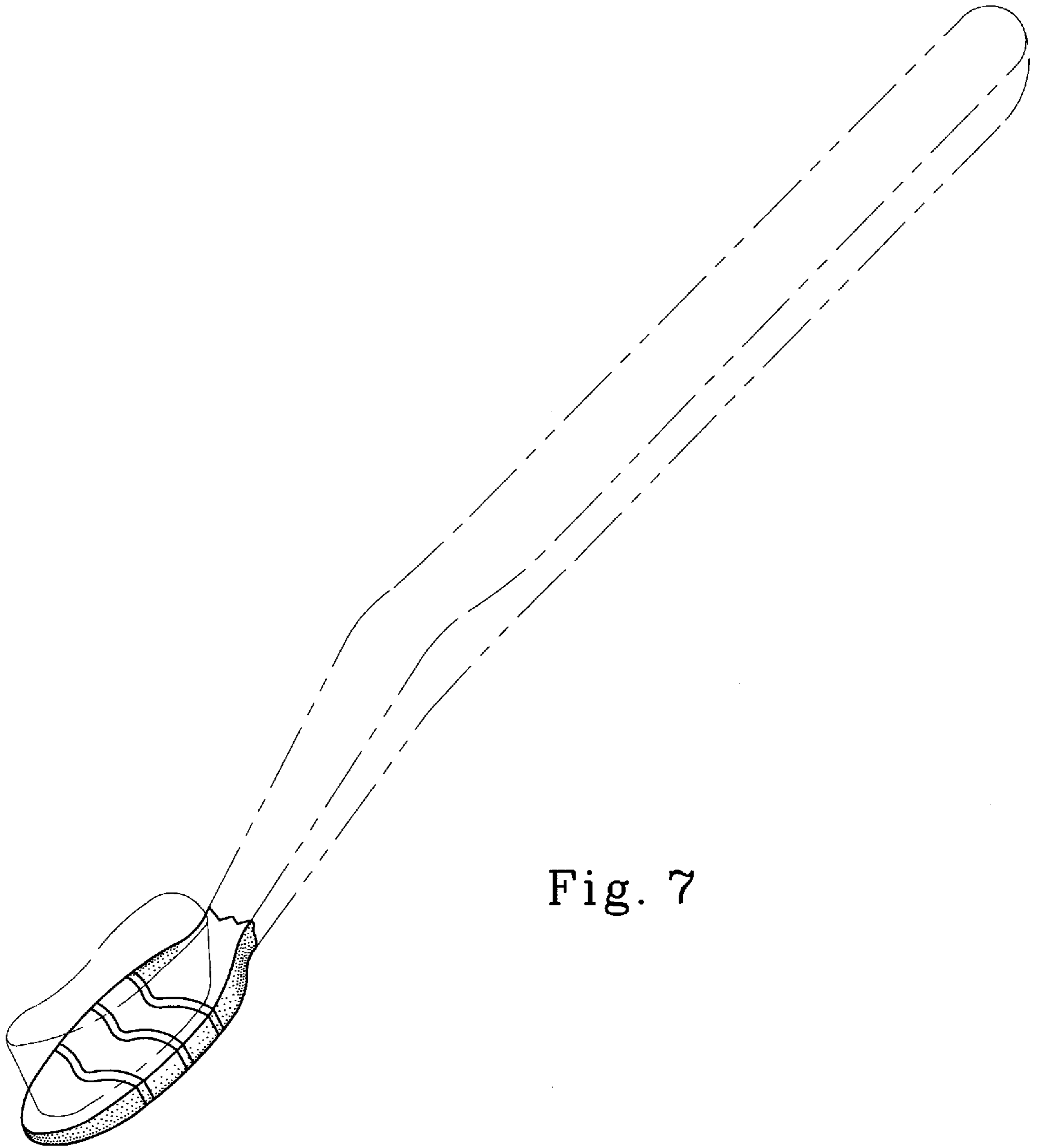

Fig. 7

Fig. 8

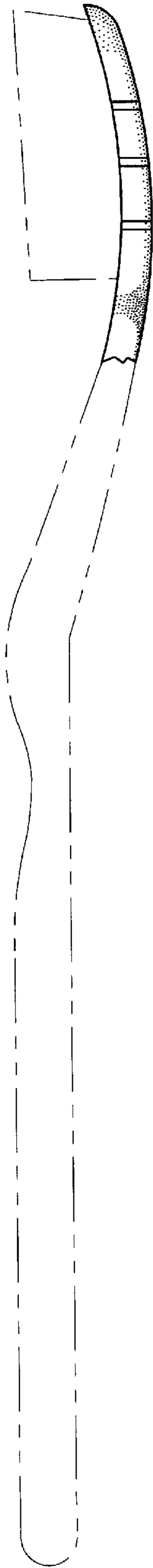

Fig. 9



Fig. 10

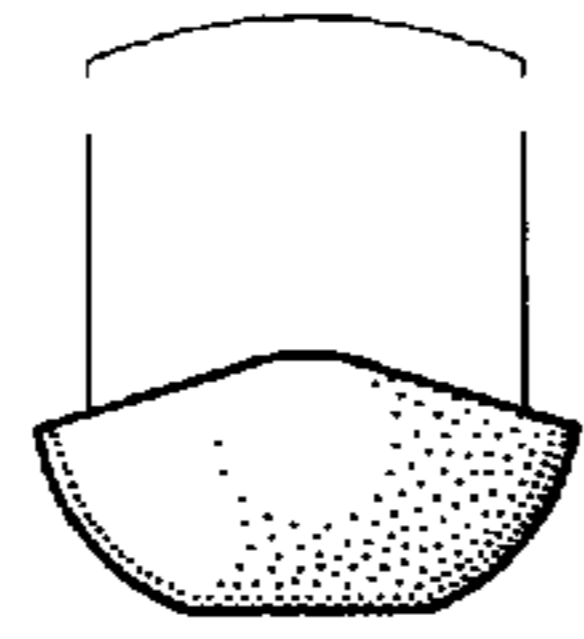
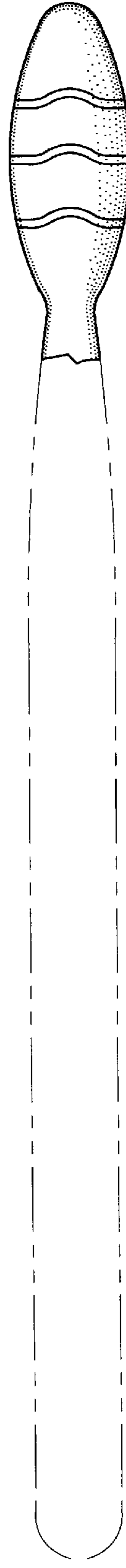

Fig. 11

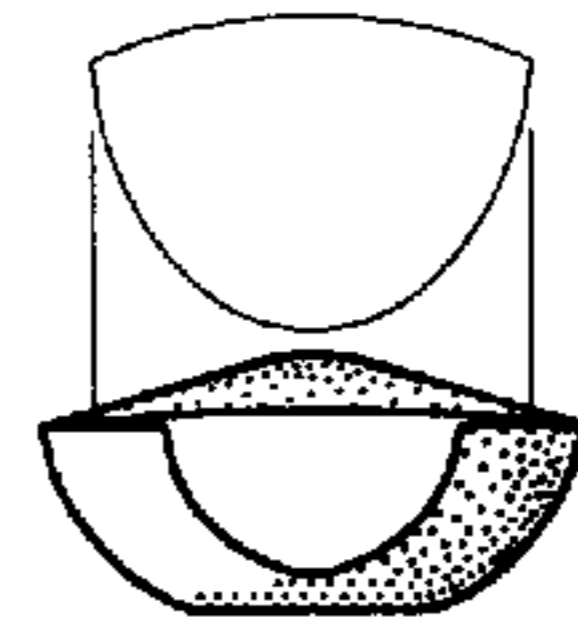

Fig. 12

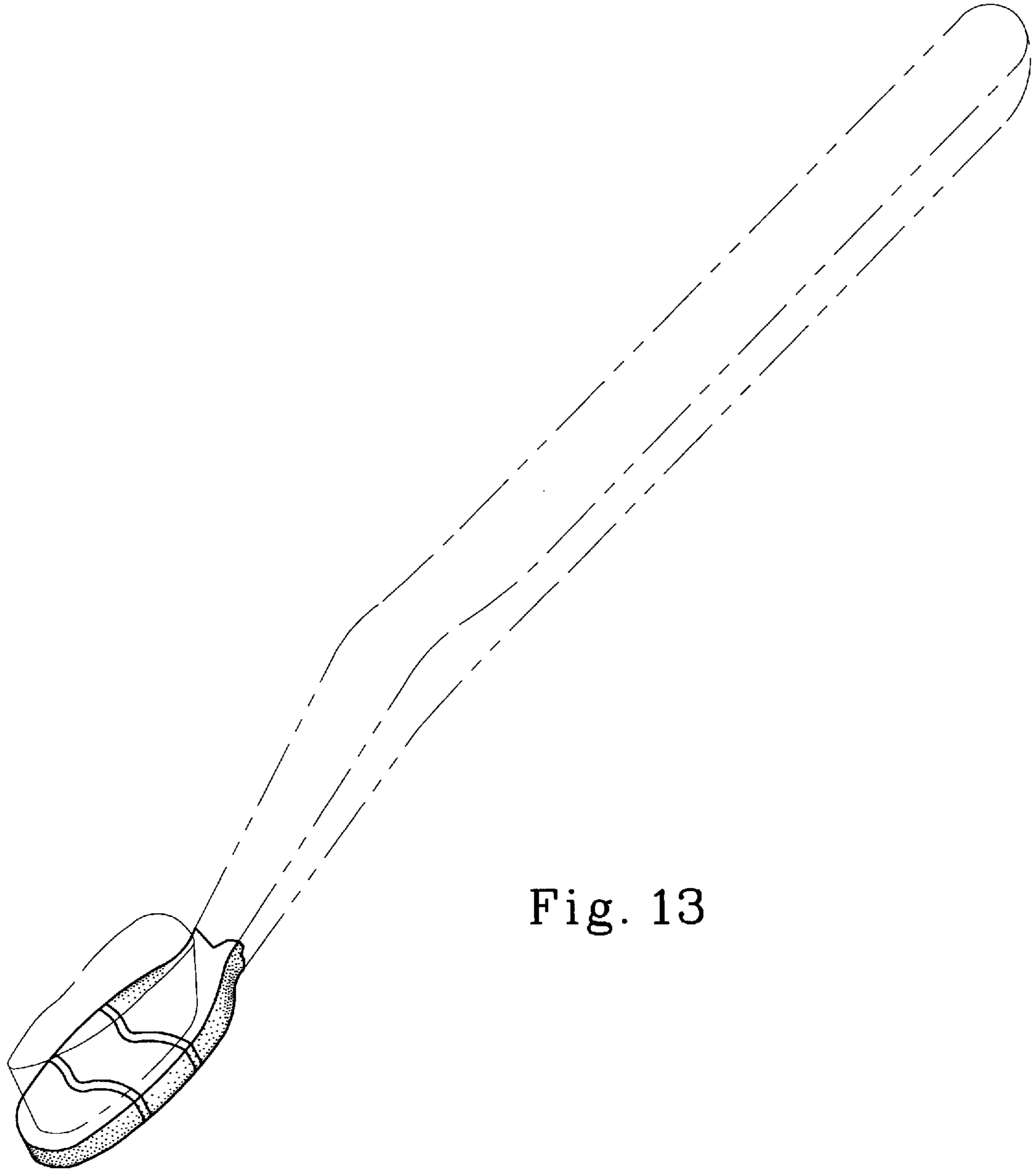

Fig. 13

Fig. 14

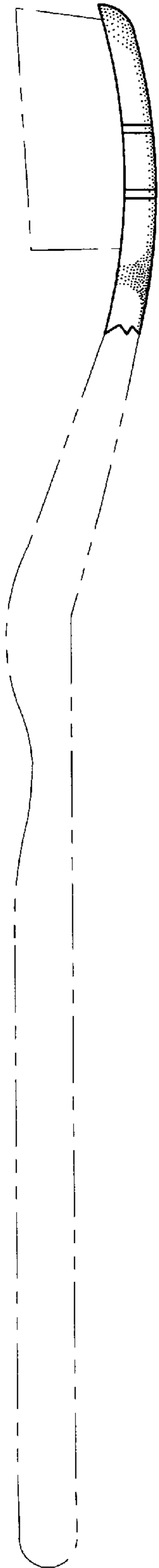

Fig. 15



Fig. 16



Fig. 17

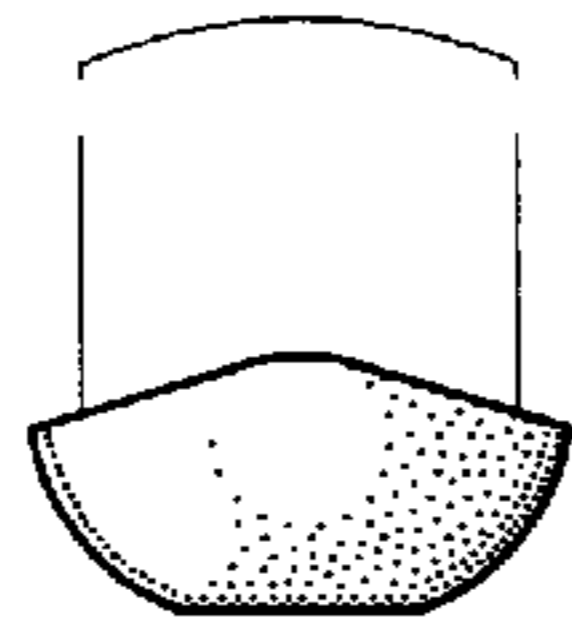
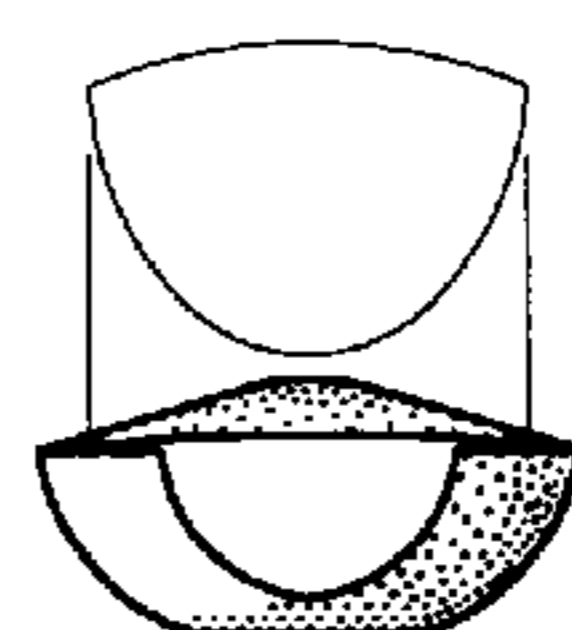

Fig. 18



UNITED STATES PATENT AND TRADEMARK OFFICE  
CERTIFICATE OF CORRECTION

PATENT NO. : Des. 407,223  
DATED : March 30, 1999  
INVENTOR(S) : Maria Van Gelder

It is certified that error appears in the above-identified patent and that said Letters Patent is hereby corrected as shown below:

On the title page, item

*[75] Inventor: Maria Van Gelder, delete "Twickenham, Rep. Of Moldova" and insert therefore -- Malmesbury, United Kingdom --.*

Signed and Sealed this  
Twelfth Day of October, 1999

Attest:



Q. TODD DICKINSON

Attesting Officer

Acting Commissioner of Patents and Trademarks