



US00D407170S

United States Patent [19] Yuen

[11] **Patent Number: Des. 407,170**

[45] **Date of Patent: **Mar. 23, 1999**

[54] **RECHARGEABLE EMERGENCY LIGHT**

D. 392,757 3/1998 Burns D26/37

[75] Inventor: **John Se-Kit Yuen**, Kowloon, Hong Kong

FOREIGN PATENT DOCUMENTS

2002268 4/1990 United Kingdom .

2007014 1/1991 United Kingdom .

[73] Assignee: **John Manufacturing Limited**, Kowloon, Hong Kong

Primary Examiner—Marcus A. Jackson
Attorney, Agent, or Firm—Fay, Sharpe, Beall, Fagan, Minnich & McKee

[**] Term: **14 Years**

[21] Appl. No.: **88,051**

[57] CLAIM

[22] Filed: **May 14, 1998**

The ornamental design for a rechargeable emergency light, as shown and described.

[30] Foreign Application Priority Data

DESCRIPTION

Nov. 17, 1997 [GB] United Kingdom 2070563

[51] **LOC (6) Cl.** **26-02**

[52] **U.S. Cl.** **D26/37**

[58] **Field of Search** D26/37-50; 362/157, 362/158, 171, 172, 178, 181, 183, 192, 194, 196, 197, 200-206

FIG. 1 is a front elevational view of a rechargeable emergency light showing my new design;
FIG. 2 is a left side elevational view thereof;
FIG. 3 is a rear elevational view thereof;
FIG. 4 is a right side elevational view thereof;
FIG. 5 is a top plan elevational view thereof;
FIG. 6 is an underneath plan elevational view thereof;
FIG. 7 is a rear elevational view with plug extended thereof;
FIG. 8 is a right side elevational view with plug extended thereof; and,
FIG. 9 is a top plan elevational view view with plug extended.

[56] References Cited

U.S. PATENT DOCUMENTS

- D. 274,949 7/1984 Bandiera D26/49
- D. 285,356 8/1986 Schosser et al. D26/49
- D. 296,478 6/1988 Powell et al. D26/49
- D. 328,145 7/1992 Yuen .
- D. 332,321 1/1993 Yuen .

1 Claim, 2 Drawing Sheets

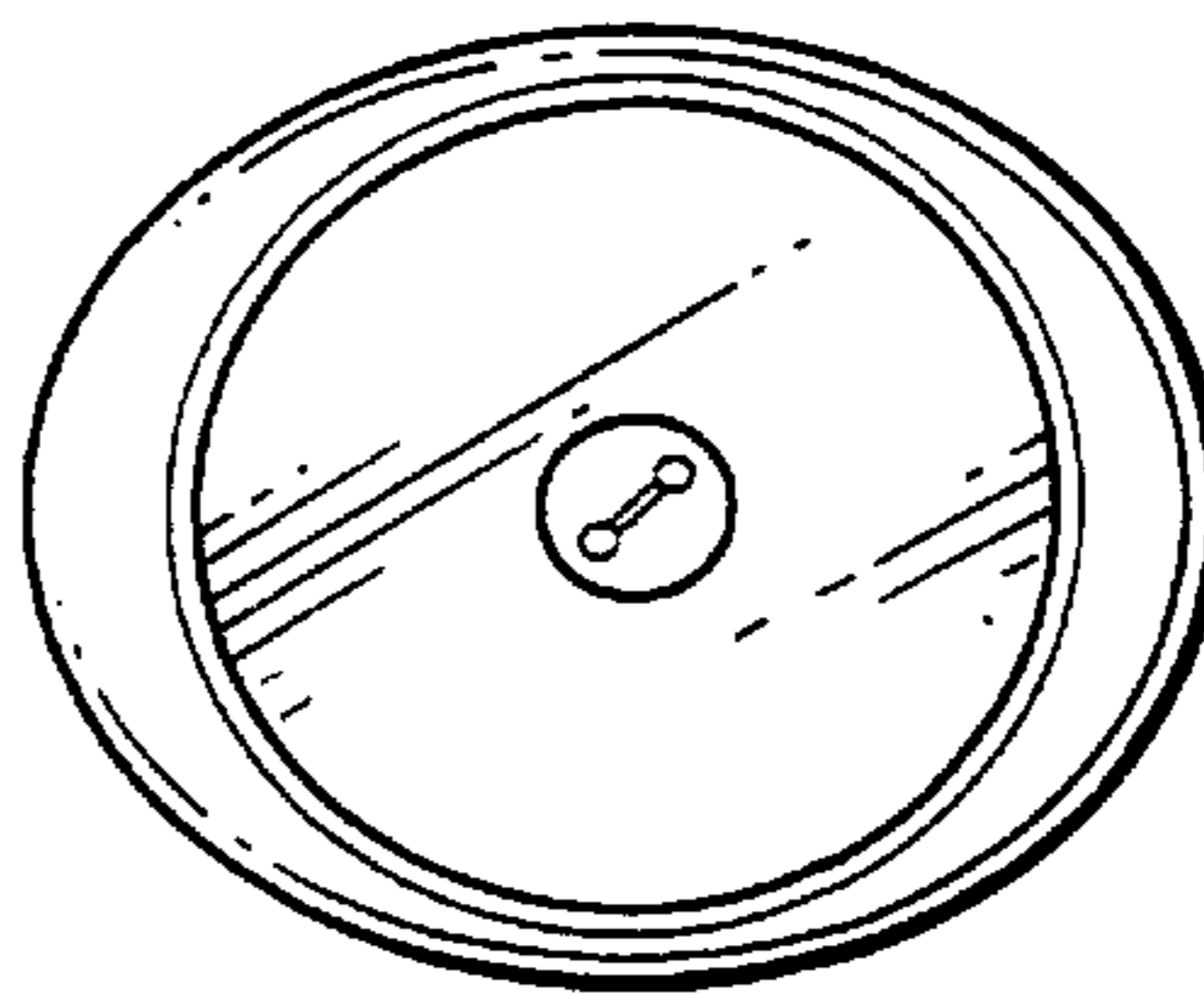
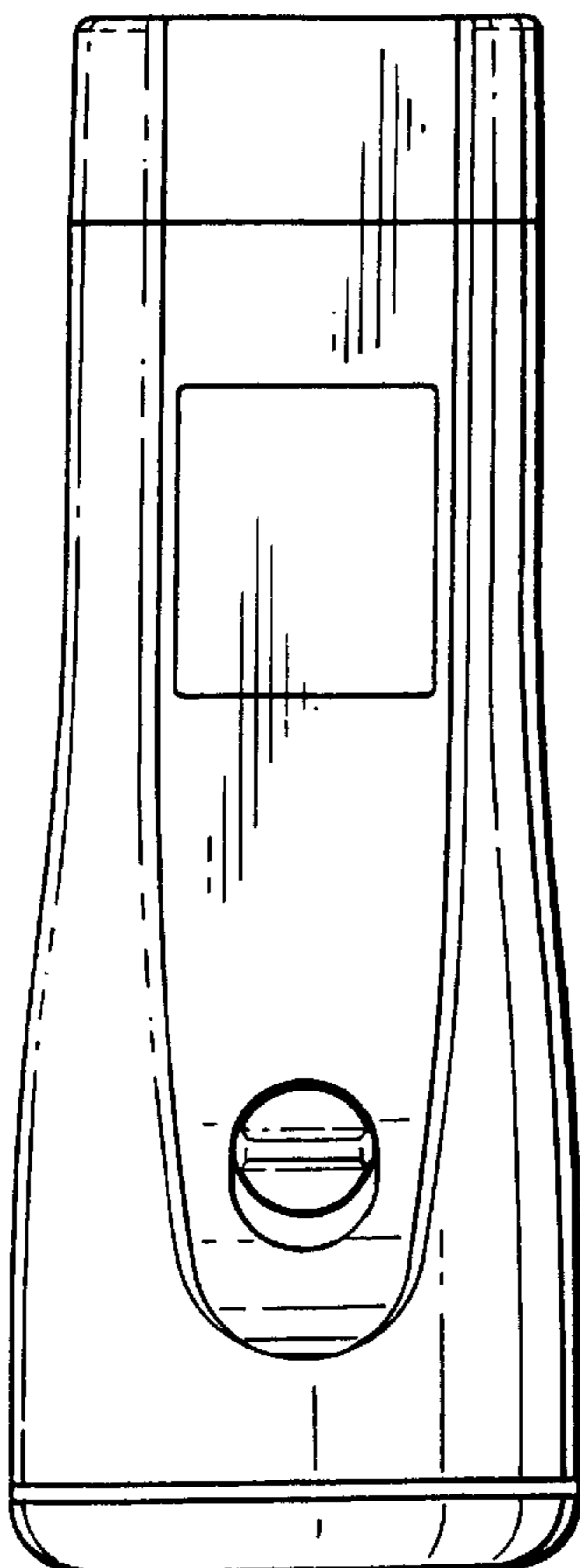

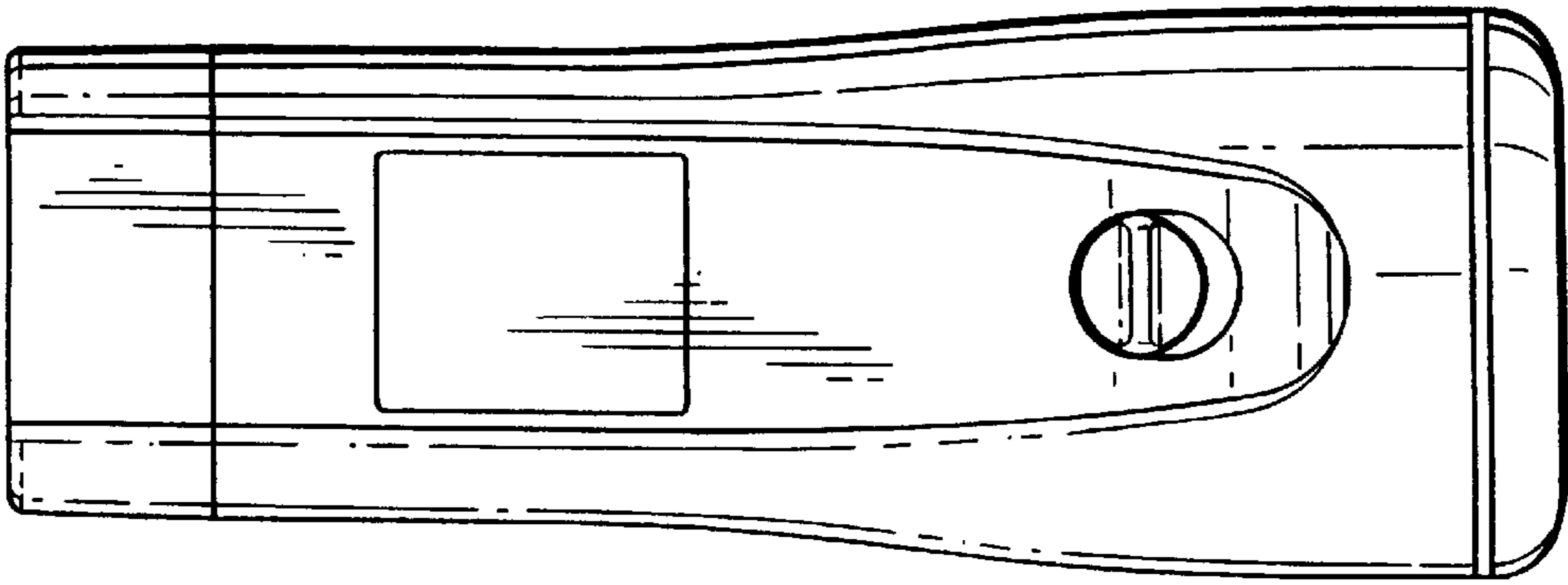

FIG. 1

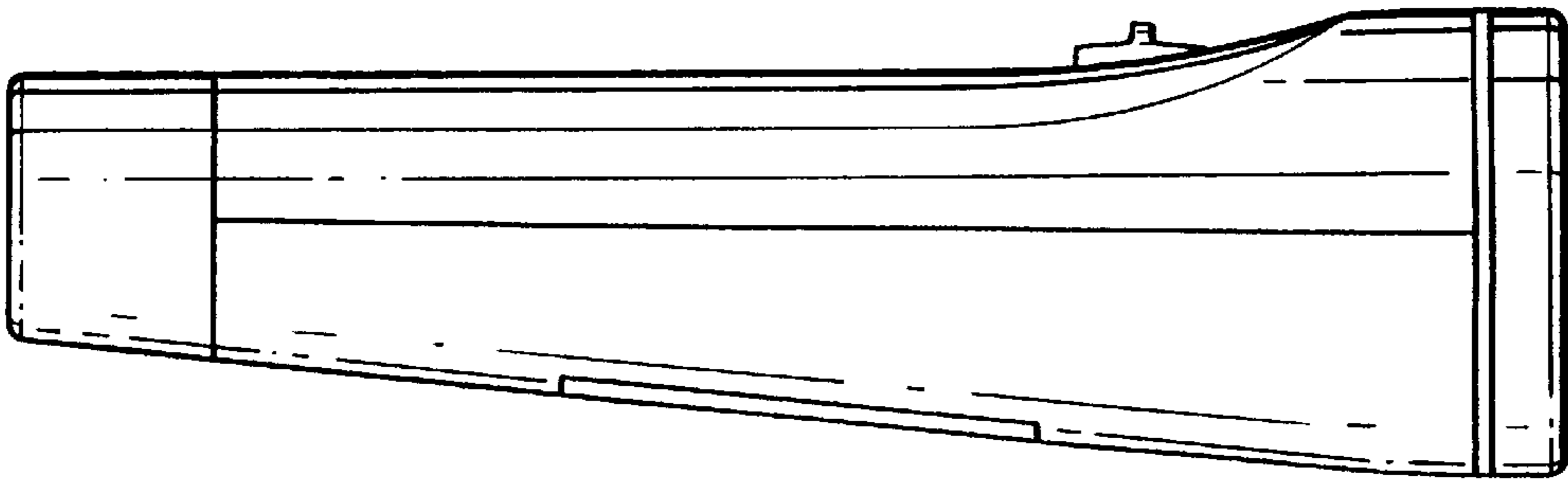

FIG. 2

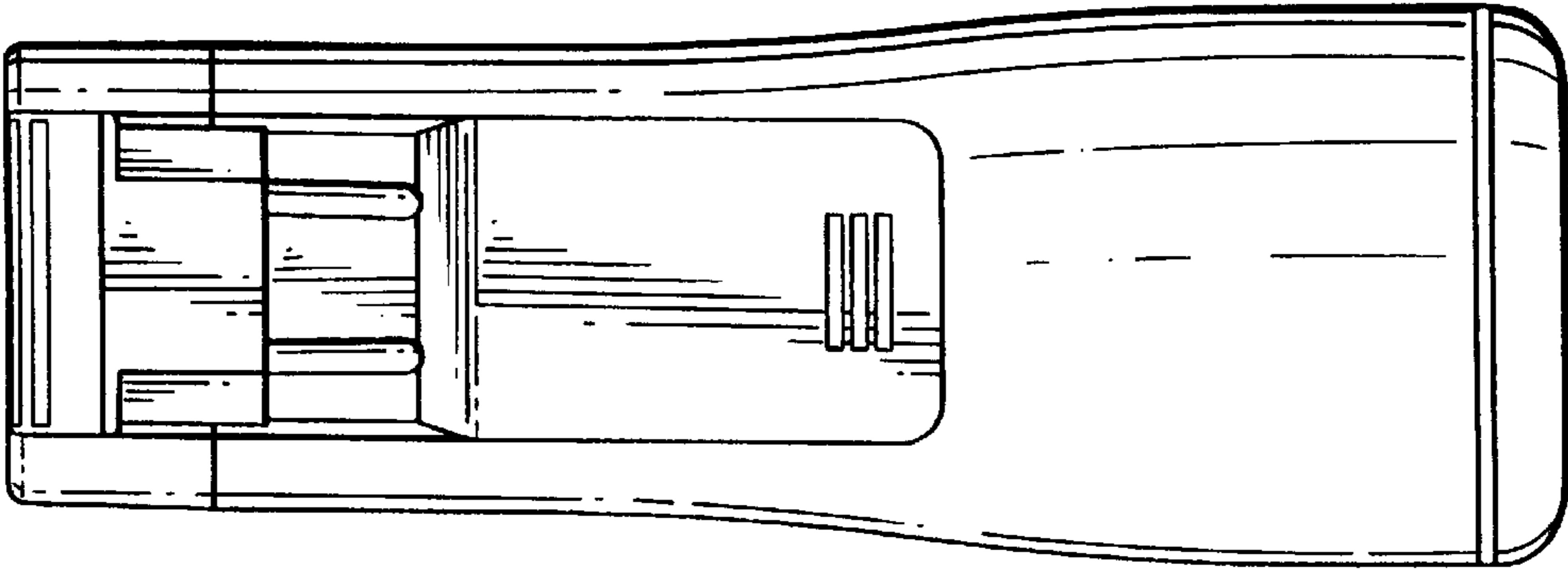

FIG. 3

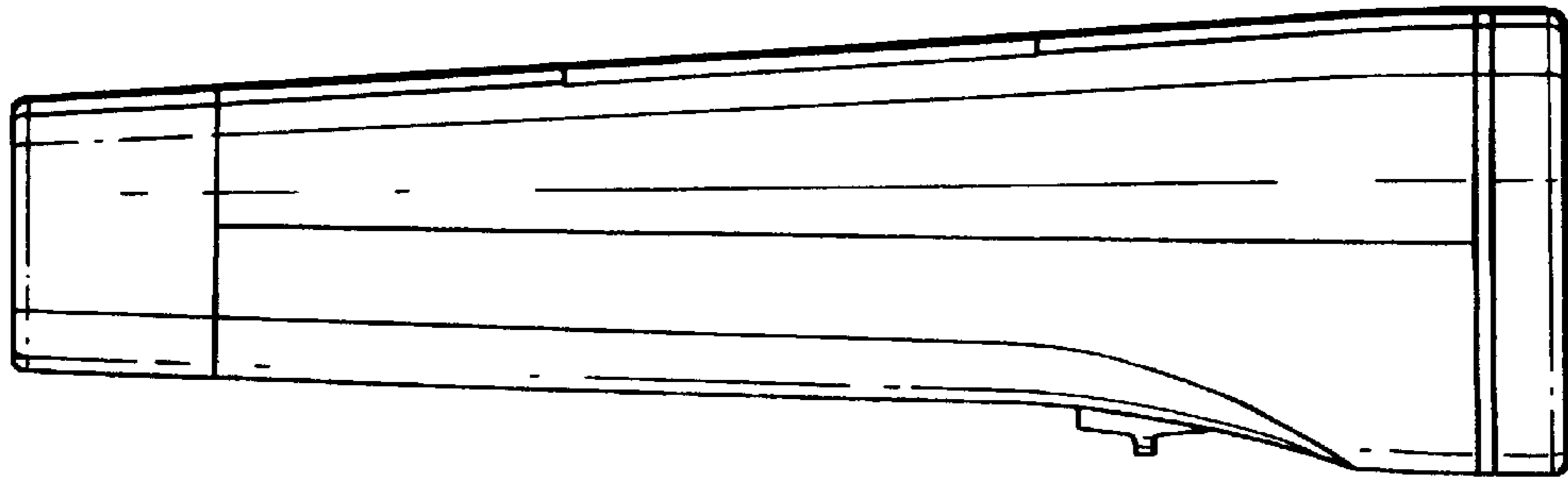

FIG. 4

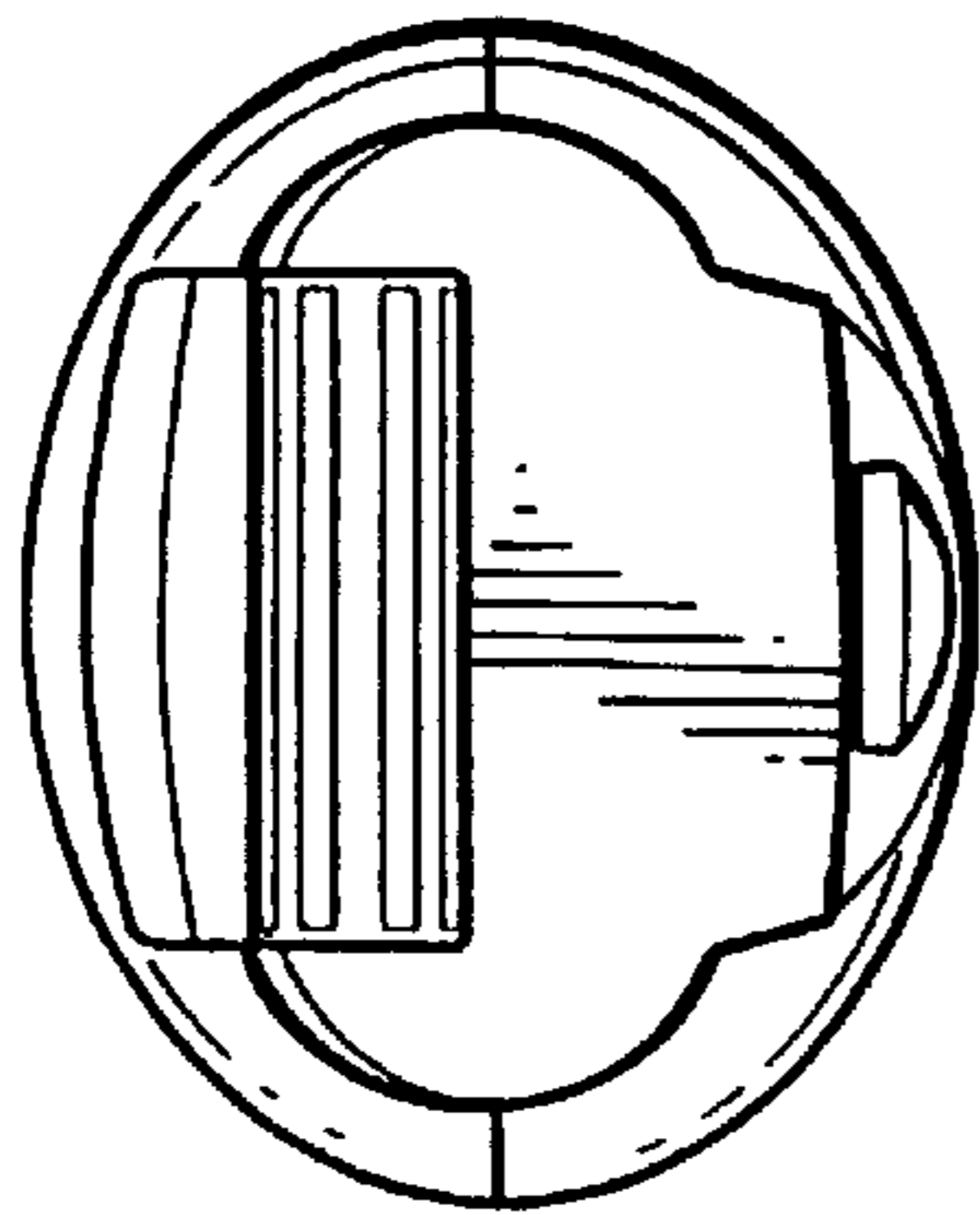

FIG. 5

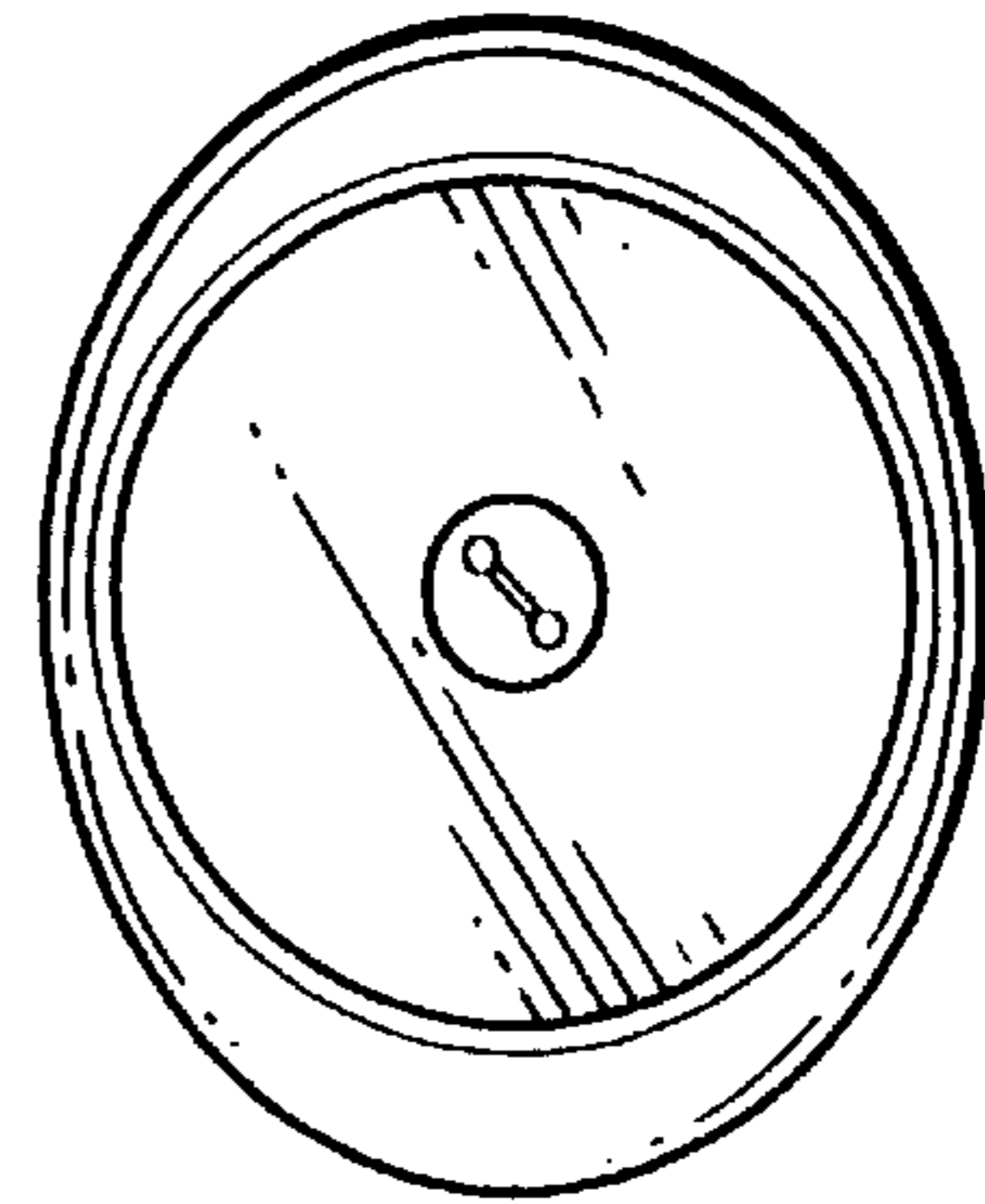

FIG. 6

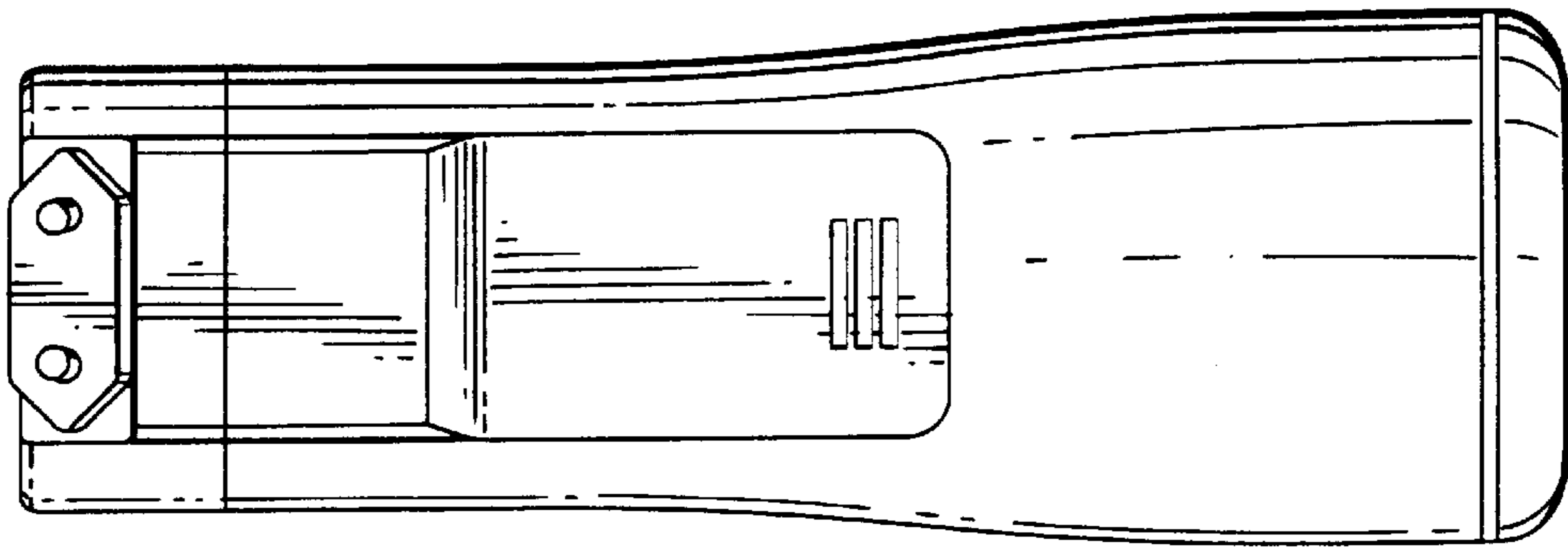

FIG. 7

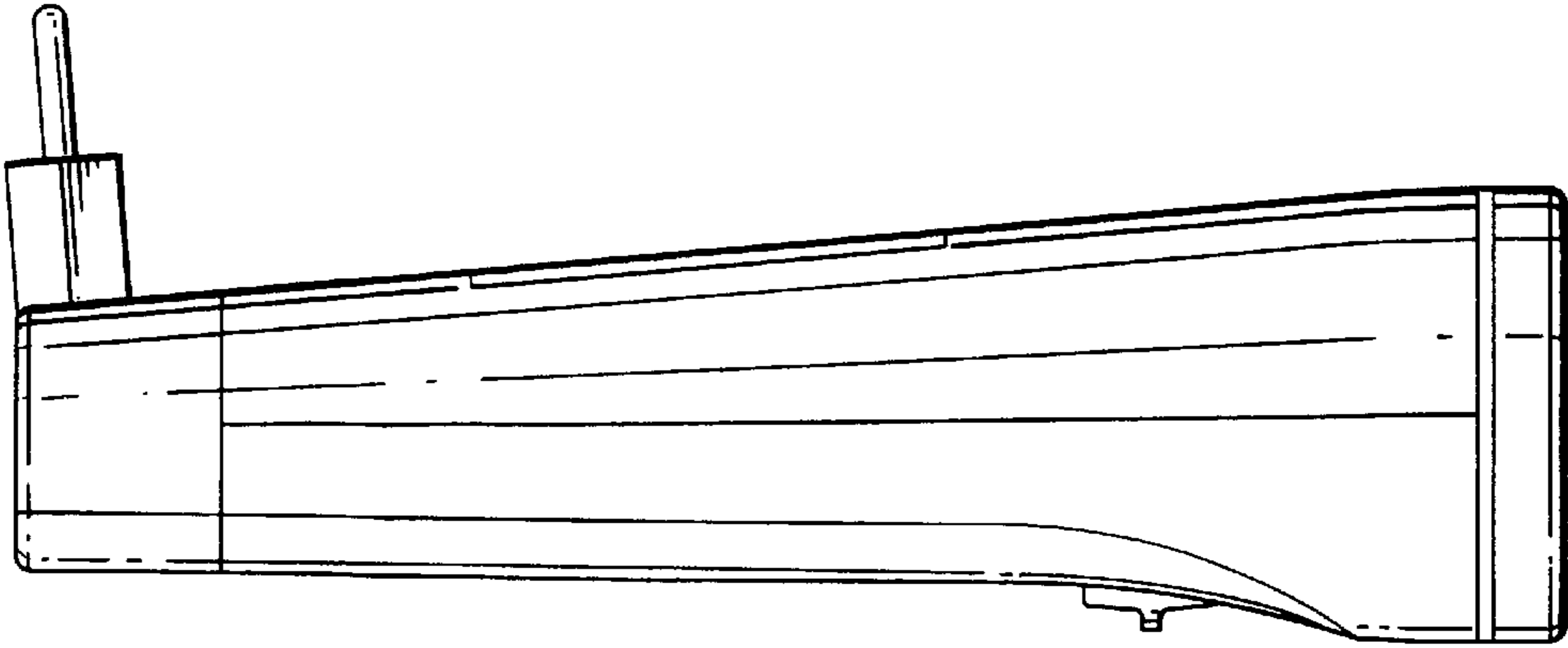

FIG. 8

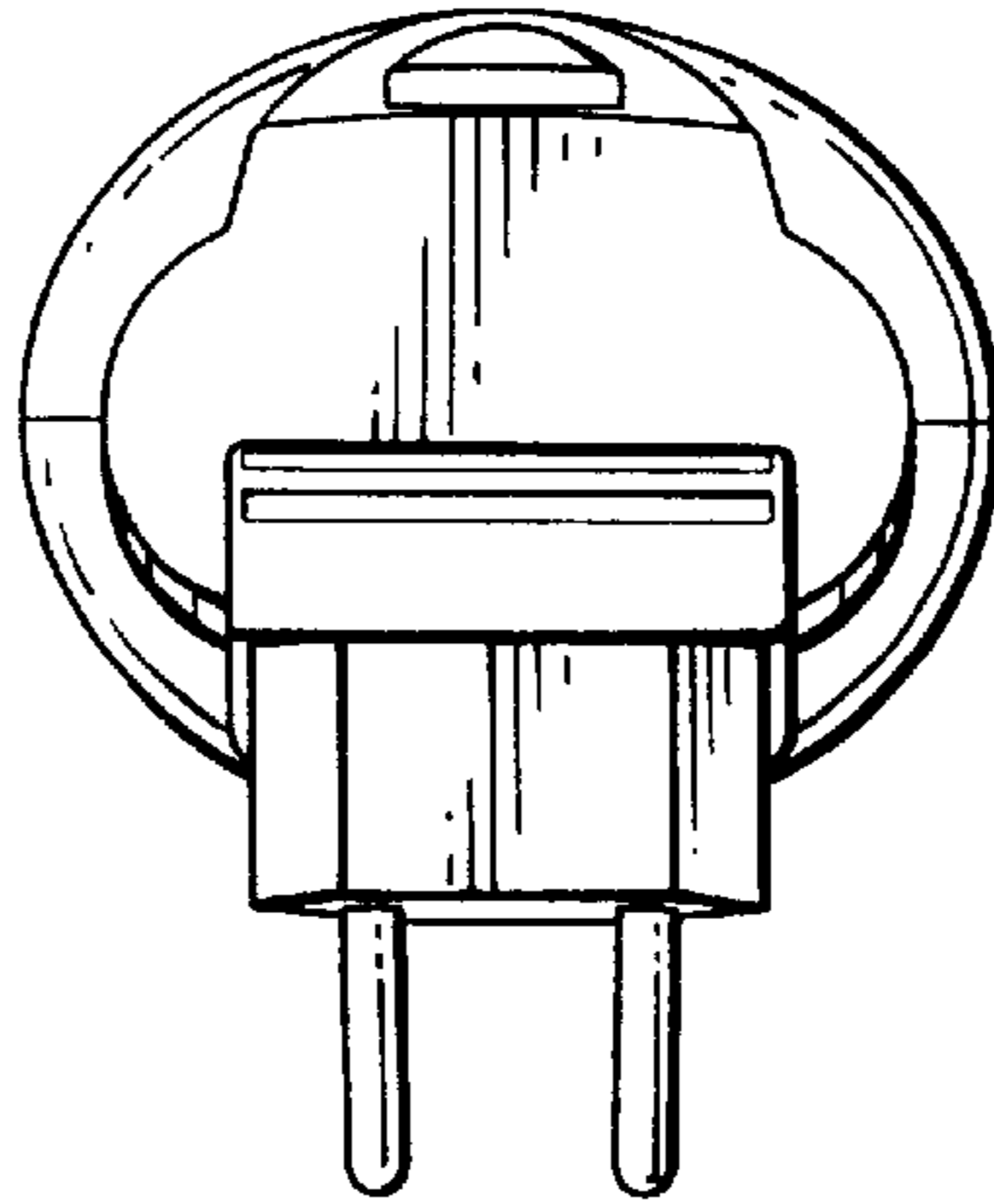

FIG. 9