



US00D407136S

# United States Patent [19]

Merrill et al.

[11] Patent Number: Des. 407,136

[45] Date of Patent: \*\*Mar. 23, 1999

[54] FISHING REEL

[75] Inventors: **Scott T. Merrill**, Mounds, Okla.;  
**William R. Worrell**, Hopkins; **Jeffrey J. Kolodziej**, Eden Prairie, both of Minn.

[73] Assignee: **Brunswick Corporation**, Lake Forest, Ill.

[\*\*] Term: **14 Years**

[21] Appl. No.: **66,240**

[22] Filed: **Feb. 7, 1997**

[51] LOC (6) Cl. .... **22-05**

[52] U.S. Cl. .... **D22/137; D22/140**

[58] Field of Search ..... D22/140, 137,  
D22/138, 141; 43/20, 23, 21, 81.1, 22;  
242/225, 227, 283, 273, 223, 240

[56] **References Cited**

**U.S. PATENT DOCUMENTS**

D. 145,625	9/1946	Hurd	.....	D22/138
D. 150,951	9/1948	Hill	.....	D22/138
892,137	6/1908	Crandall	.....	242/273
1,544,128	6/1925	Budd et al.	.....	242/223
1,572,104	2/1926	Budd	.....	43/20
2,120,068	6/1938	Griswold	.....	242/283
2,578,477	12/1951	Hurd	.....	43/20

2,746,695	5/1956	Clay	.....	43/20
2,752,717	7/1956	Lind	.....	43/20
2,783,952	3/1957	Clay	.....	242/233
3,351,300	11/1967	Nagy	.....	242/240
4,673,143	6/1987	Intengan	.....	D22/137
5,444,934	8/1995	La Touche	.....	431/18.1

**OTHER PUBLICATIONS**

Design News Jun. 1959, p. 87, Tough Tache Reel.  
Modern Plastic, Apr. 1953, p. 106 Tenite II Fishing Reel.

*Primary Examiner*—Doris V. Coles  
*Attorney, Agent, or Firm*—Rosenblatt & Redano P.C.

[57] **CLAIM**

The ornamental design for fishing reel, as shown and described.

**DESCRIPTION**

FIG. 1 is a front elevational view of a fishing reel, showing our new design;  
FIG. 2 is a top plan view thereof;  
FIG. 3 is a bottom plan view thereof;  
FIG. 4 is a left side elevational view thereof;  
FIG. 5 is a rear elevational view thereof; and,  
FIG. 6 is a right side elevational view thereof.  
The broken line showing of part of a fishing rod in FIGS. 2-4 and 6 is for illustrative purposes only and forms no part of the claimed design.

**1 Claim, 5 Drawing Sheets**

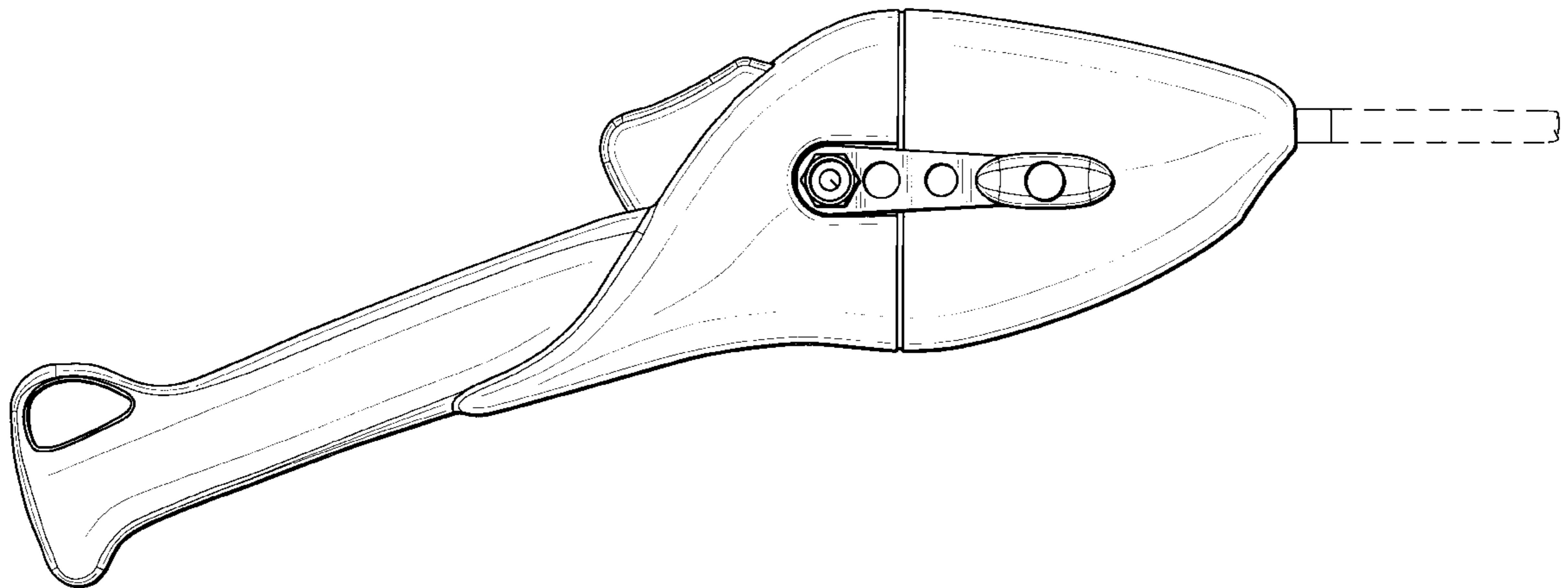

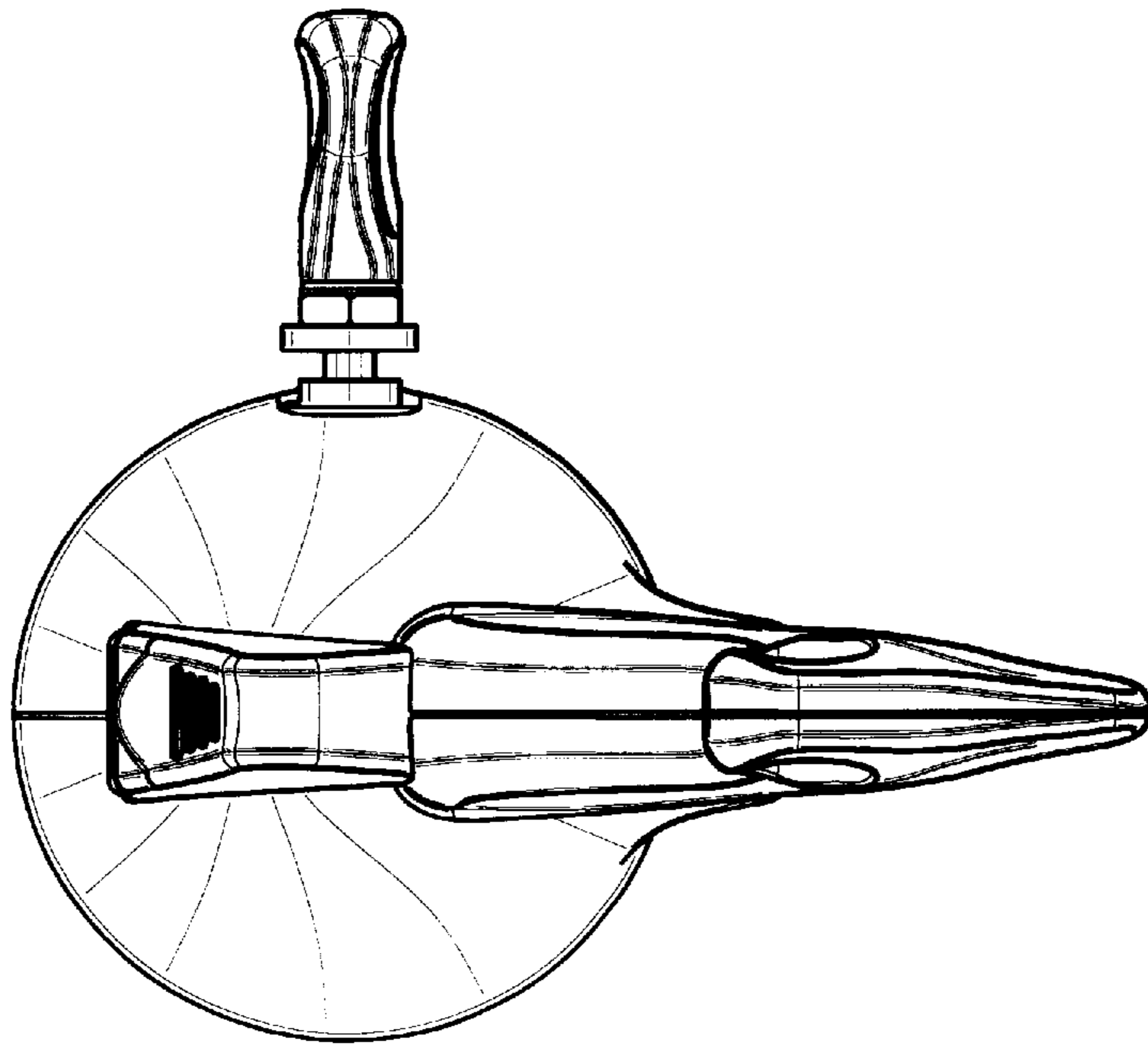

**FIG. 5**

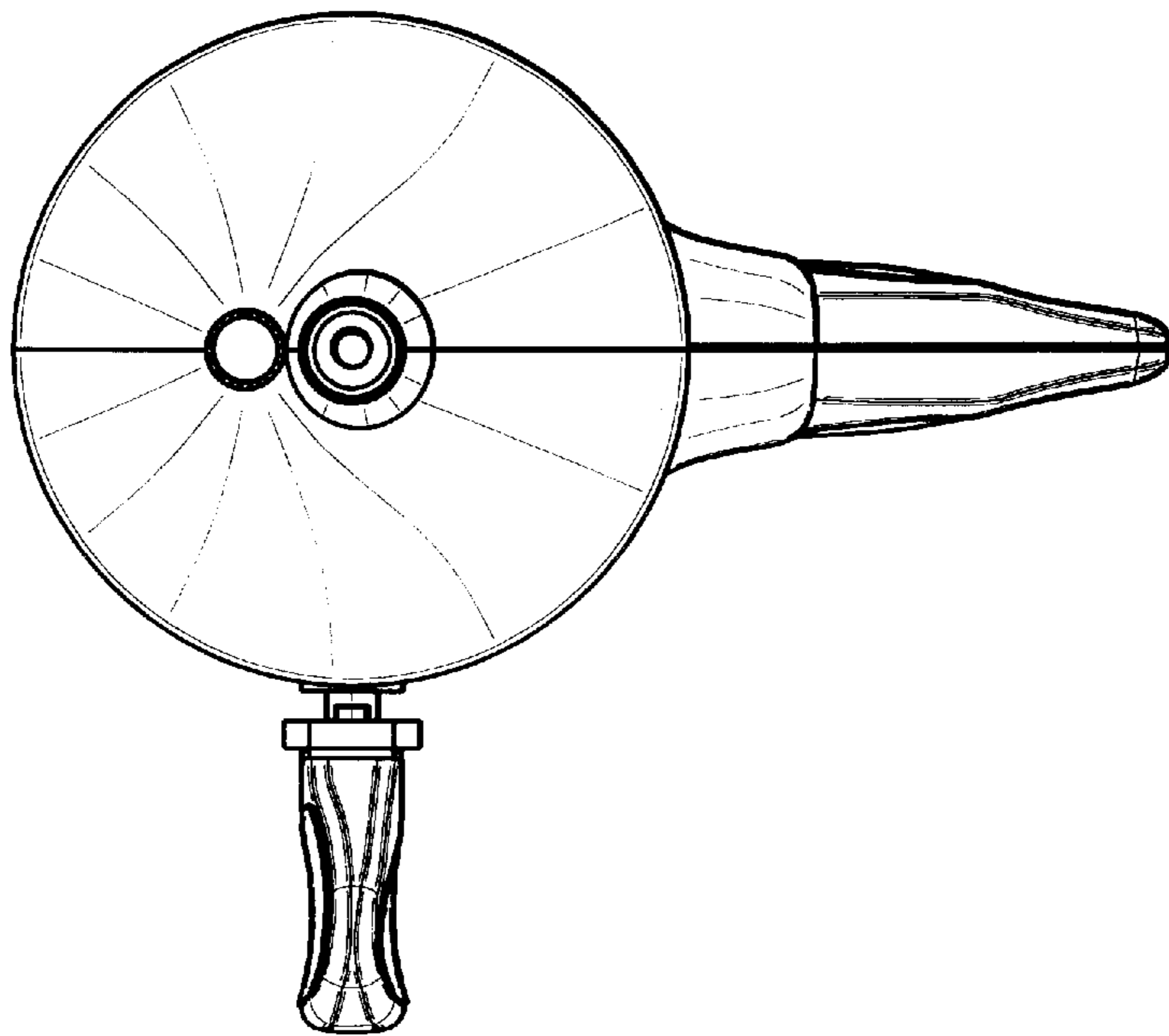

**FIG. 1**

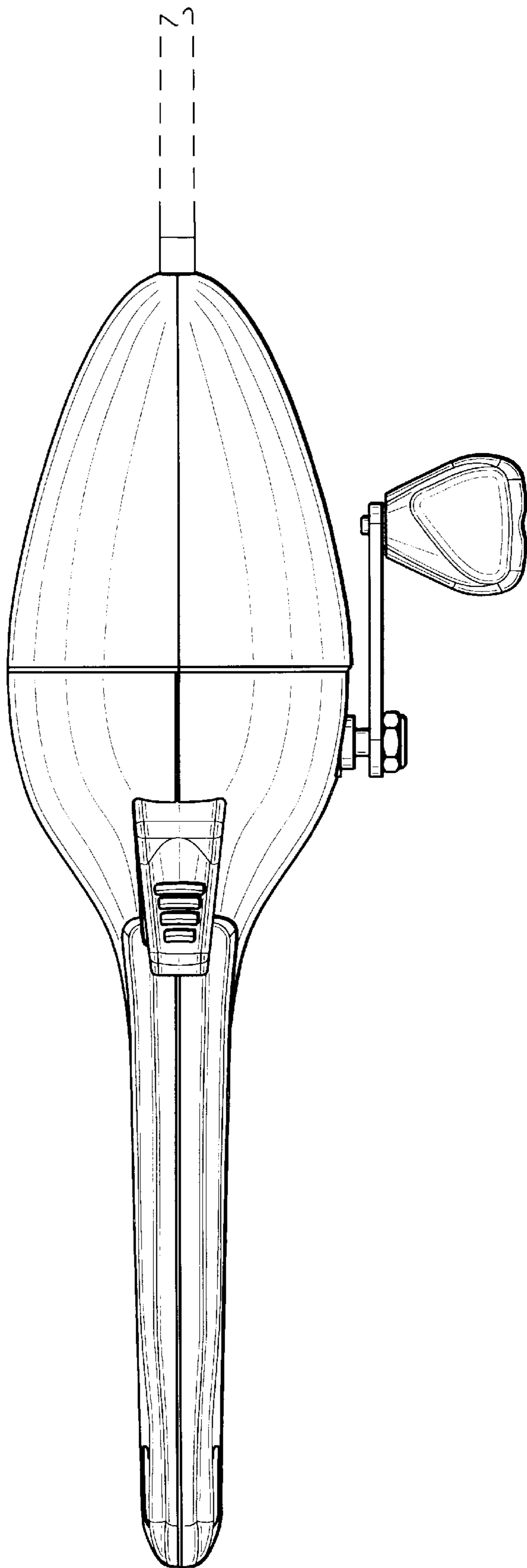

FIG. 2

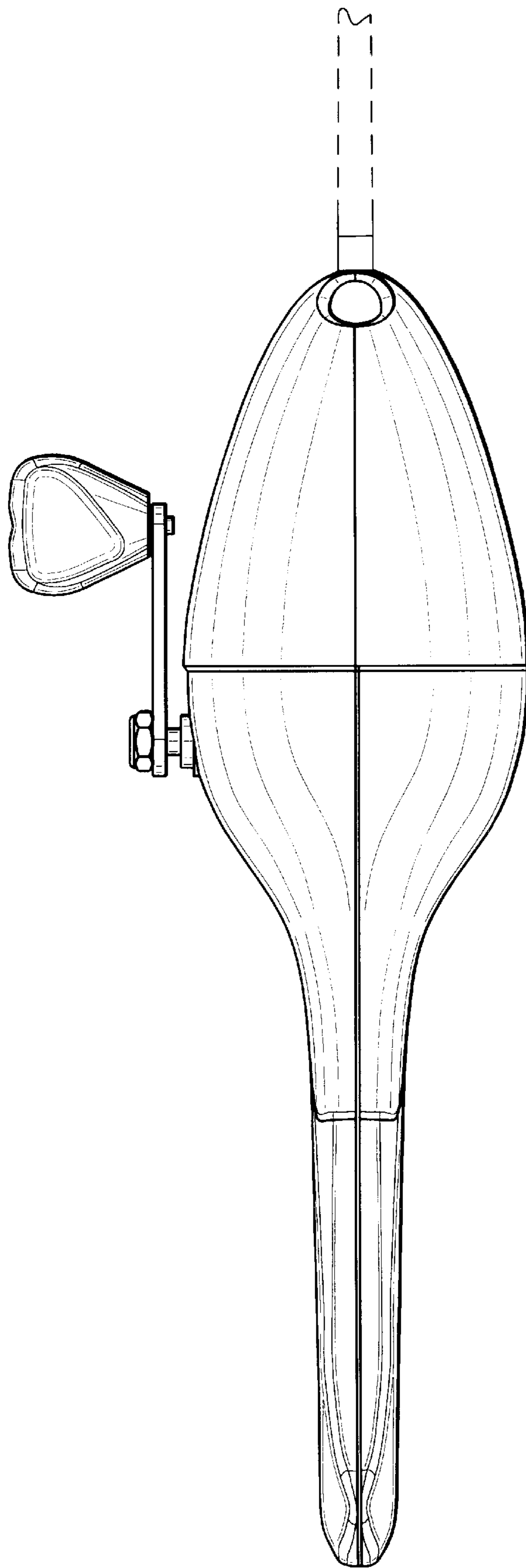
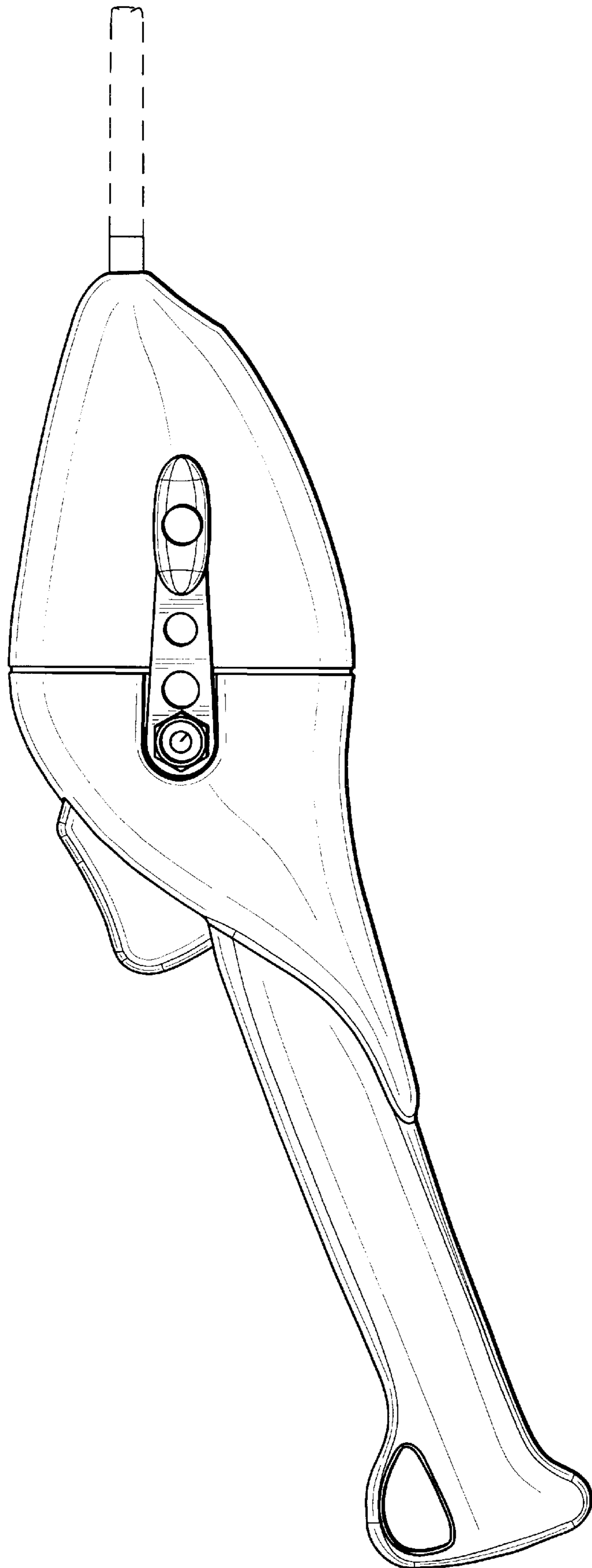
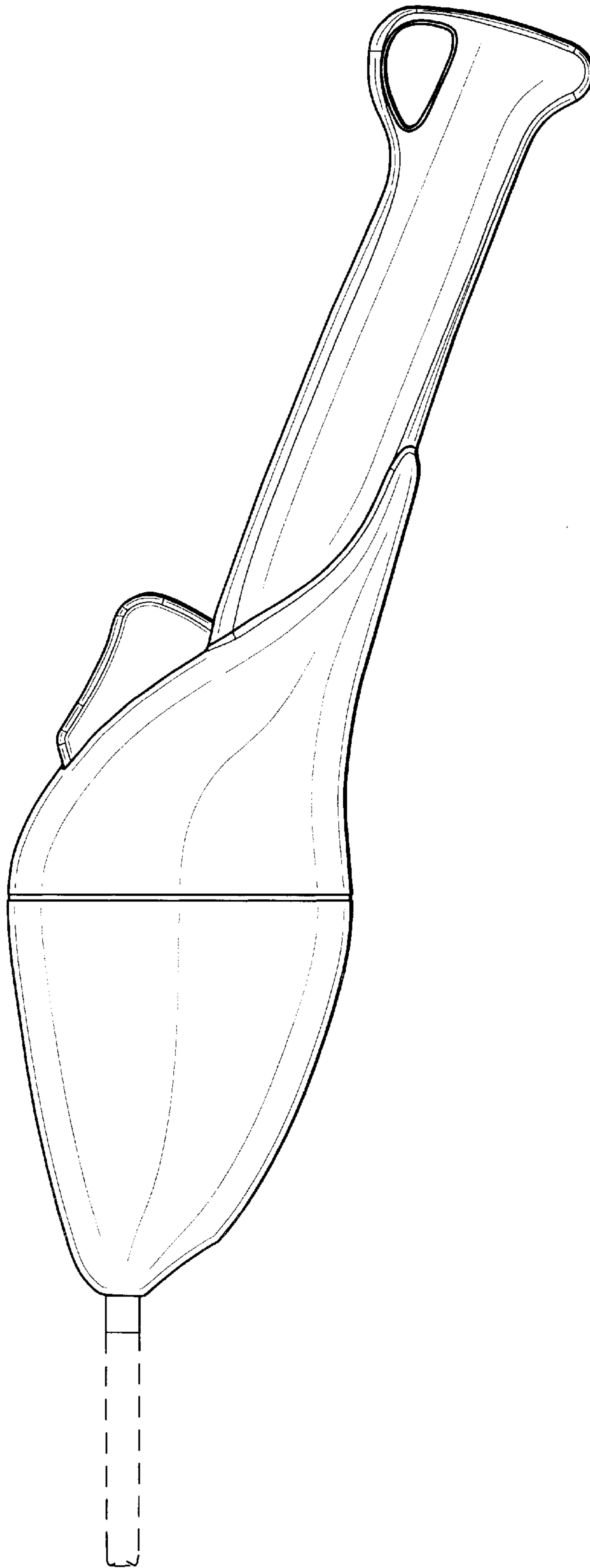

FIG. 3



**FIG. 4**



**FIG. 6**