



US00D407084S

# United States Patent [19]

Waalder et al.

[11] **Patent Number: Des. 407,084**

[45] **Date of Patent: \*\*Mar. 23, 1999**

[54] **TAPE CARTRIDGE HOUSING**

[75] Inventors: **Luke Waalder**, Loveland, Colo.;  
**Thomas W. von Alten**, Boise, Id.

[73] Assignee: **Hewlett-Packard Company**, Palo Alto, Calif.

[\*\*] Term: **14 Years**

[21] Appl. No.: **84,903**

[22] Filed: **Mar. 11, 1998**

[51] **LOC (6) Cl.** ..... **14-99**

[52] **U.S. Cl.** ..... **D14/121; D21/332**

[58] **Field of Search** ..... D14/121, 100,  
D14/114, 122, 199; 273/148 B; 463/1, 30,  
43-47; D21/324, 332; 360/132, 133; 242/348,  
348.1, 341

[56] **References Cited**

**U.S. PATENT DOCUMENTS**

D. 318,273	7/1991	Takaichi	.....	D14/121
D. 325,468	4/1992	Ohba	.....	D14/121
D. 330,370	10/1992	Tseng	.....	D14/121 X
D. 375,304	11/1996	Takahata et al.	.....	D14/121

D. 381,977	8/1997	Nagata et al.	.....	D14/121
D. 393,014	3/1998	Ho et al.	.....	D21/324
D. 395,430	6/1998	Tatenuma	.....	D14/121
5,362,068	11/1994	Liu	.....	463/44
5,653,638	8/1997	Nagata	.....	463/44

**OTHER PUBLICATIONS**

Nintendo 64/64 bit, Jun. 1996.

*Primary Examiner*—Prabhakar G. Deshmukh

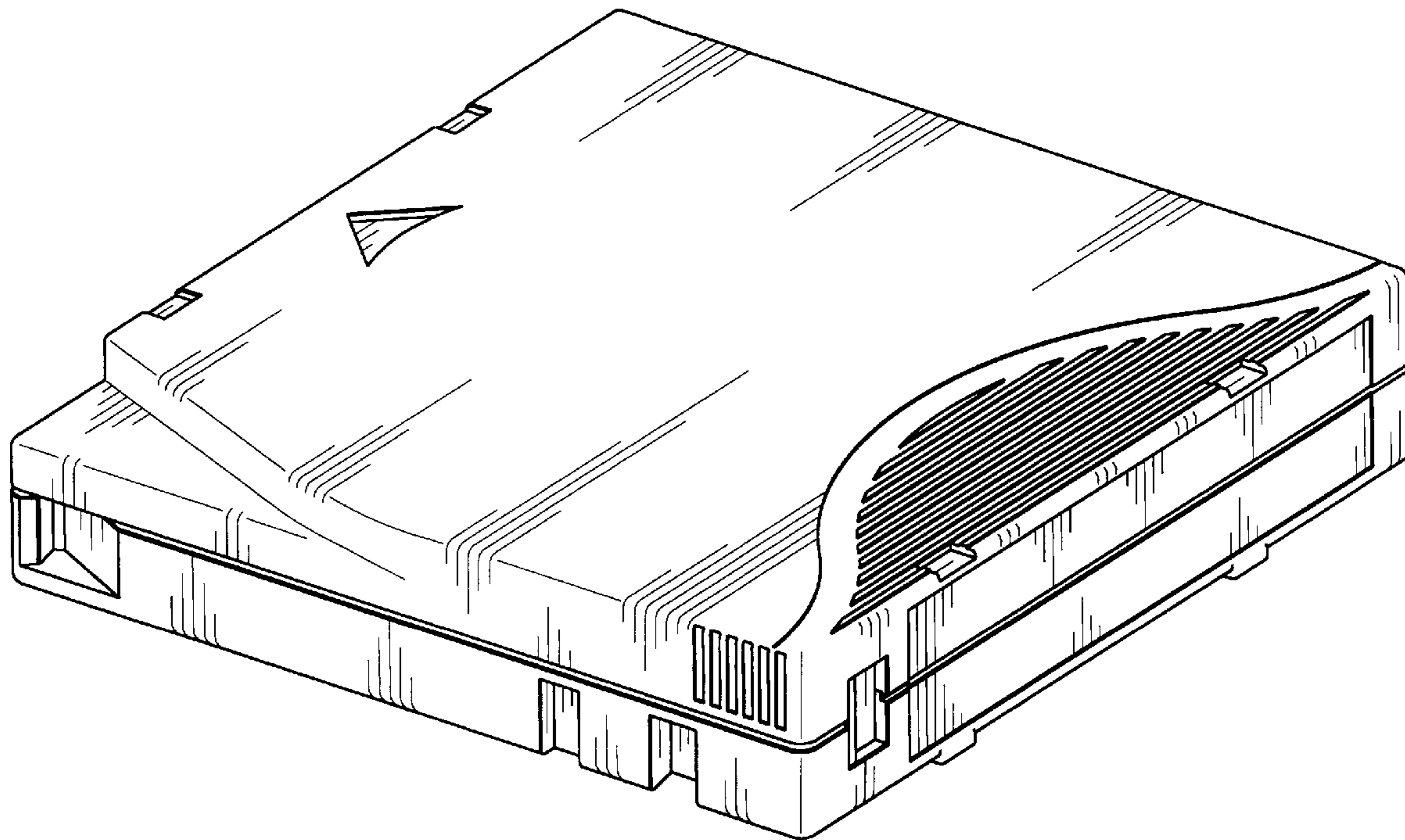
[57] **CLAIM**

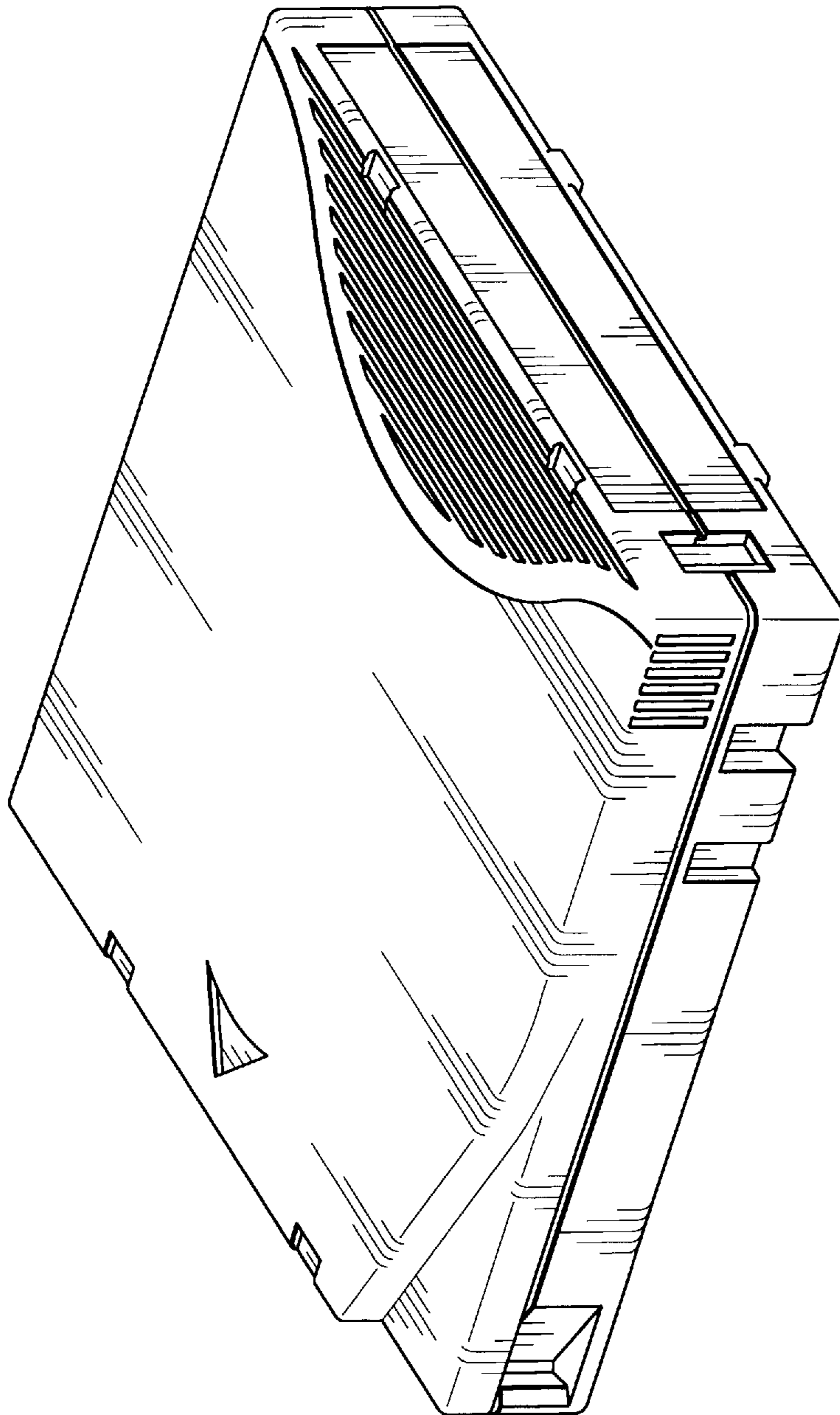
The ornamental design for a tape cartridge housing, as shown.

**DESCRIPTION**

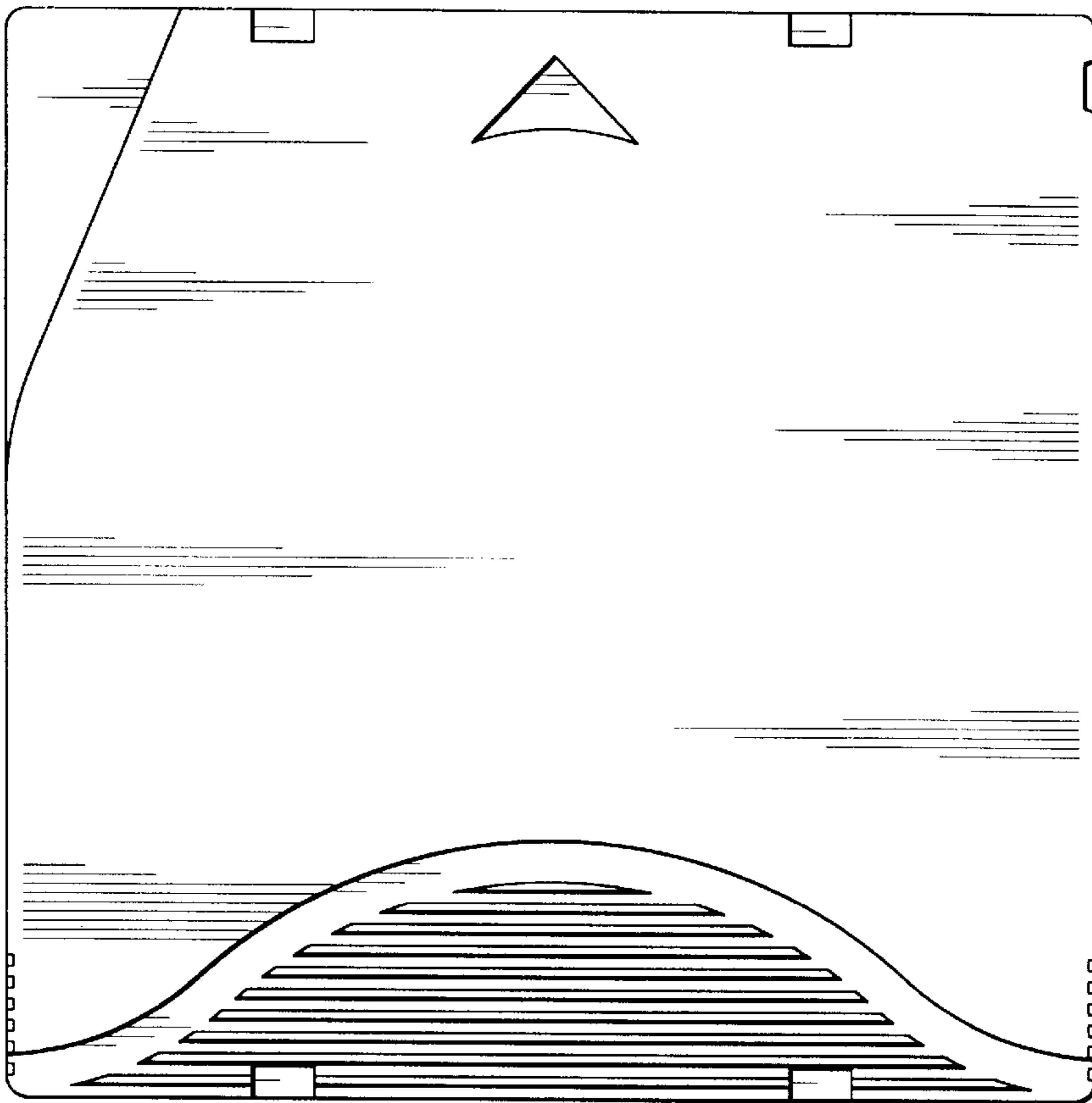
FIG. 1 is a front isometric view of a tape cartridge housing showing our new design;  
 FIG. 2 is a top plan view thereof;  
 FIG. 3 is a bottom plan view thereof;  
 FIG. 4 is a back view thereof;  
 FIG. 5 is a front view thereof;  
 FIG. 6 is a right side view thereof; and,  
 FIG. 7 is a left side view thereof.

**1 Claim, 3 Drawing Sheets**

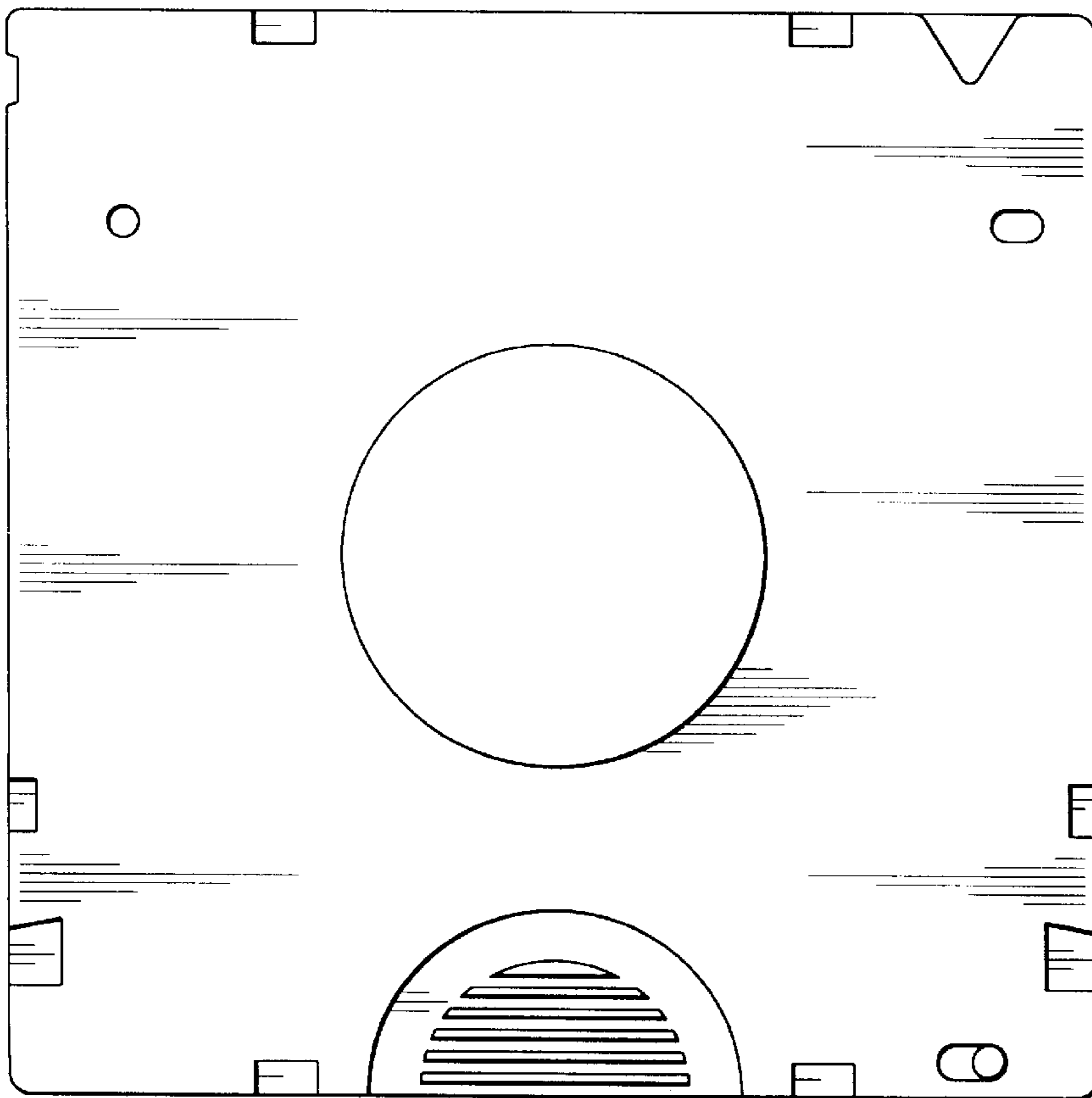




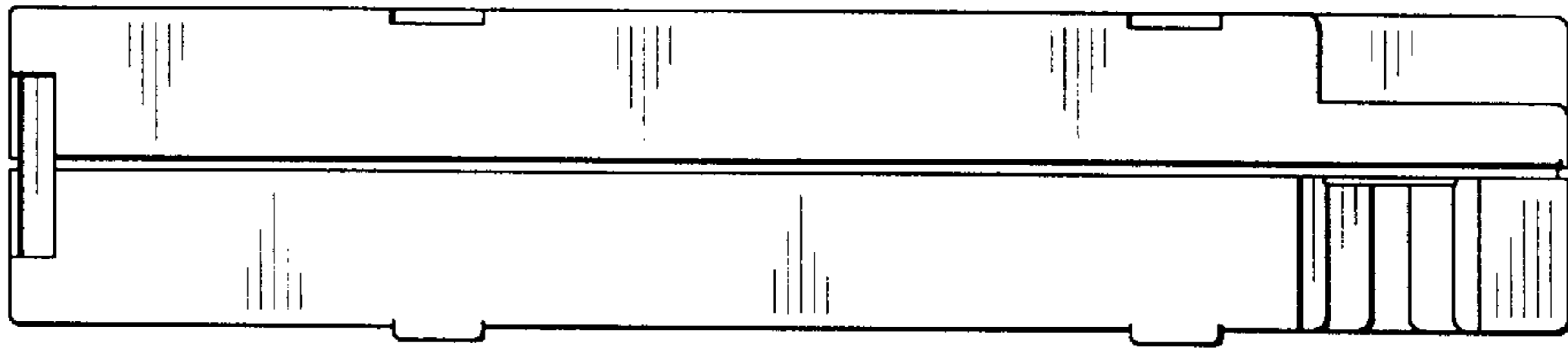
*Fig. 1*



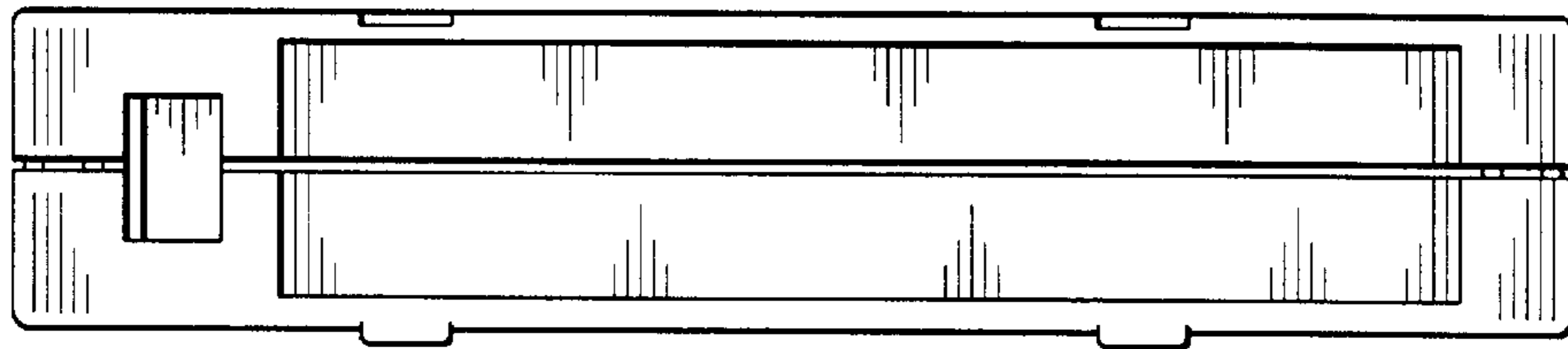
*Fig. 2*



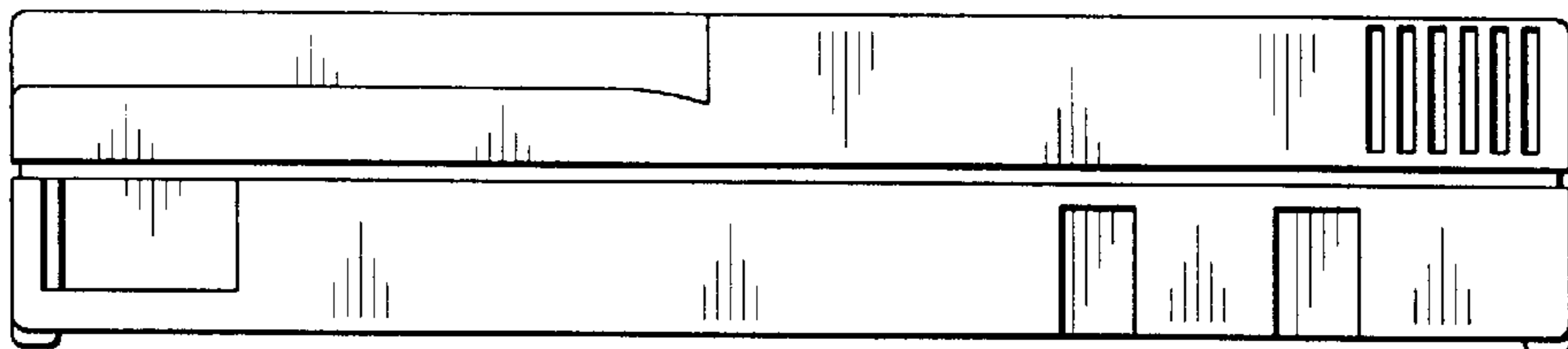
*Fig. 3*



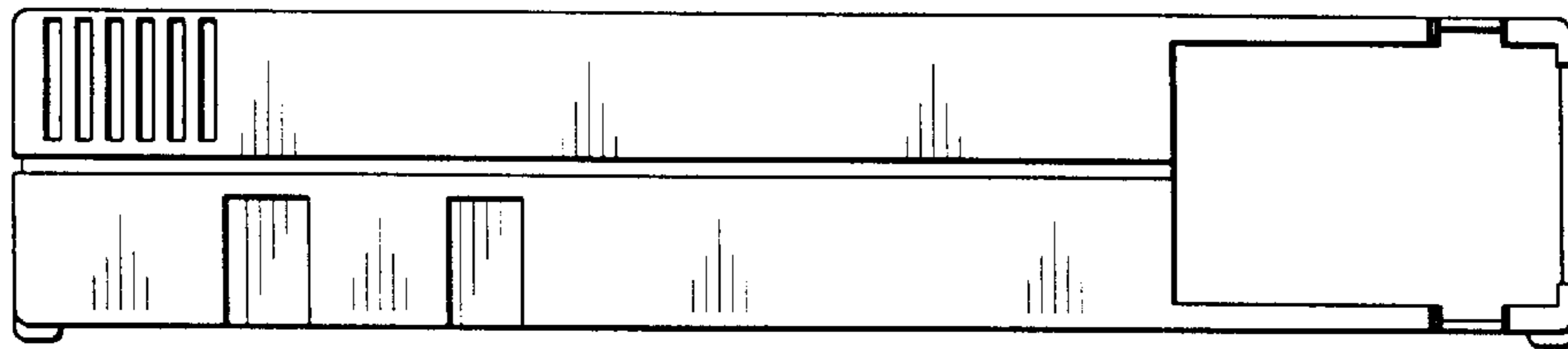
*Fig 4*



*Fig 5*



*Fig 6*



*Fig 7*