



US00D407063S

United States Patent [19]

Reis, Jr. et al.

[11] Patent Number: Des. 407,063

[45] Date of Patent: **Mar. 23, 1999

[54] BATTERY HOUSING FOR A CELLULAR TELEPHONE

[75] Inventors: Robert C. Reis, Jr., Lake In The Hills; Albert Leo Nagele, Wilmette, both of Ill.; Willard F. Amero, Jr., Flowery Branch, Ga.

[73] Assignee: Motorola, Inc., Schaumburg, Ill.

[**] Term: 14 Years

[21] Appl. No.: 88,068

[22] Filed: May 14, 1998

[51] LOC (6) Cl. 13-02

[52] U.S. Cl. D13/103

[58] Field of Search D13/103; 429/96-100, 429/163, 176

[56] References Cited

U.S. PATENT DOCUMENTS

| | | | |
|------------|---------|----------------------|---------|
| D. 353,361 | 12/1994 | Nagele et al. . | |
| D. 372,896 | 8/1996 | Nagele et al. . | |
| D. 382,538 | 8/1997 | Brunette . | |
| D. 386,742 | 11/1997 | Amero, Jr. et al. . | |
| D. 387,328 | 12/1997 | Ueda | D13/103 |
| D. 392,939 | 3/1998 | Finke-Anlauff | D13/103 |
| 5,604,050 | 2/1997 | Brunette et al. | 429/96 |
| 5,607,791 | 3/1997 | Garcia et al. . | |

Primary Examiner—Joel Sincavage

Attorney, Agent, or Firm—Sylvia Chen

[57] CLAIM

The ornamental design for a battery housing for a cellular telephone, as shown.

DESCRIPTION

FIG. 1 is a front, bottom, and left side perspective view of a first embodiment of the battery housing for a cellular telephone;

FIG. 2 is a left side elevation view of the first embodiment;

FIG. 3 is a front elevation view of the first embodiment;

FIG. 4 is a bottom plan view of the first embodiment;

FIG. 5 is a top plan view of the first embodiment;

FIG. 6 is a right side elevation view of the first embodiment;

FIG. 7 is a rear elevation view of the first embodiment;

FIG. 8 is a front, bottom, and left side perspective view of a second embodiment of the battery housing for a cellular telephone;

FIG. 9 is a left side elevation view of the second embodiment;

FIG. 10 is a front elevation view of the second embodiment;

FIG. 11 is a bottom plan view of the second embodiment;

FIG. 12 is a top plan view of the second embodiment;

FIG. 13 is a right side elevation view of the second embodiment; and,

FIG. 14 is a rear elevation view of the second embodiment.

The broken line matter in FIGS. 1-7 is included for the purpose of illustrating environmental structure only and forms no part of the first embodiment.

1 Claim, 6 Drawing Sheets

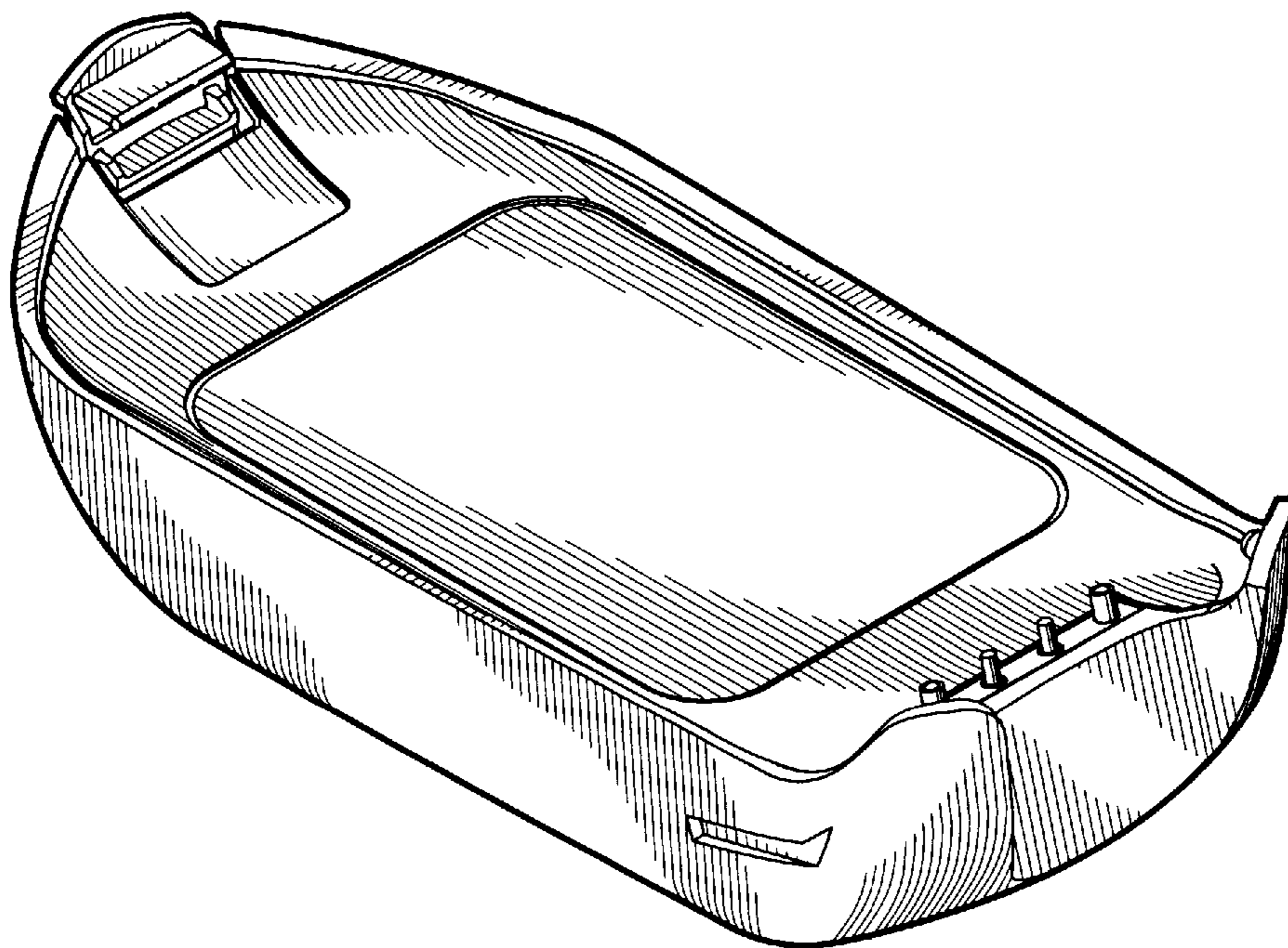

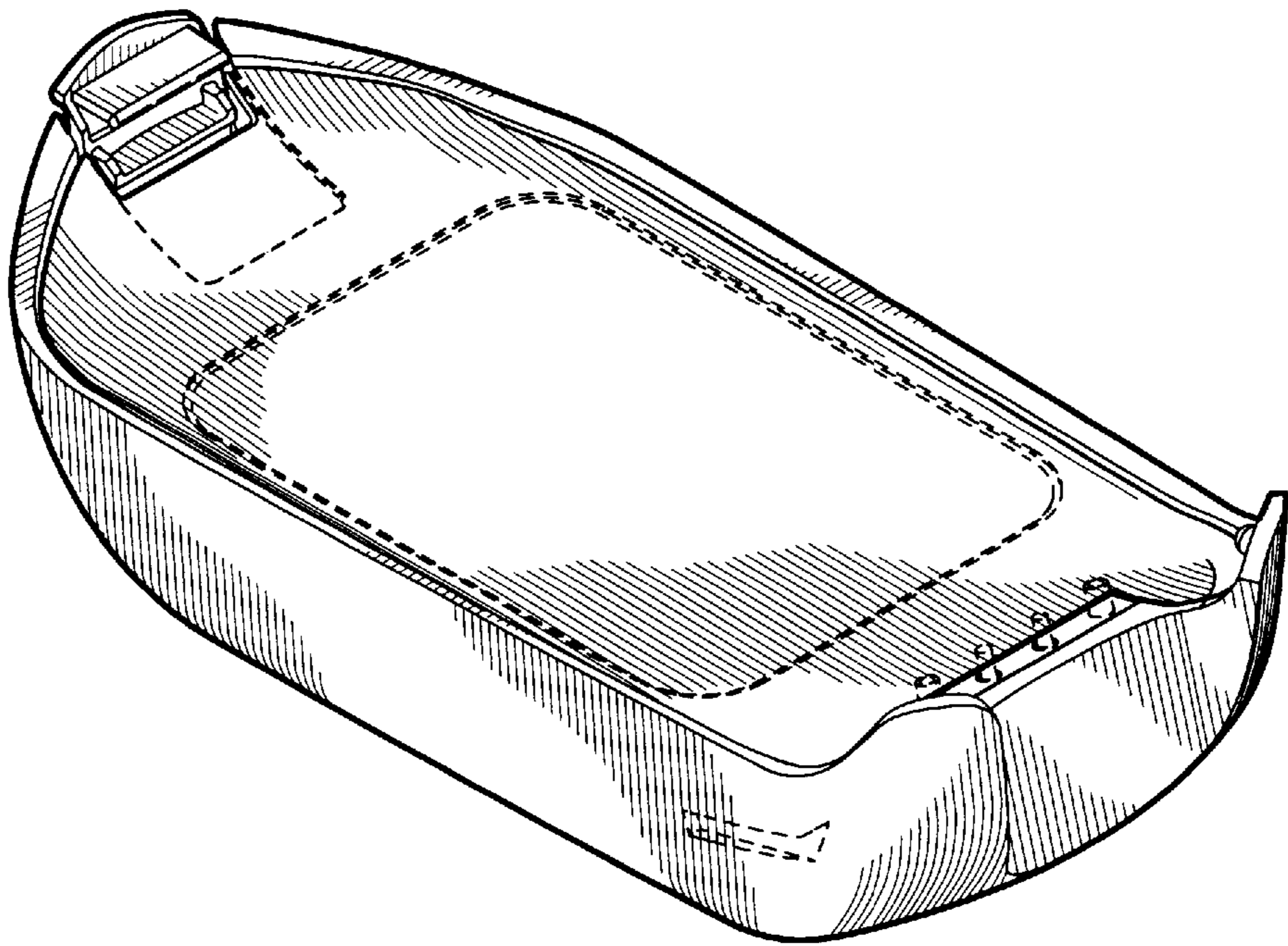

FIG. 1

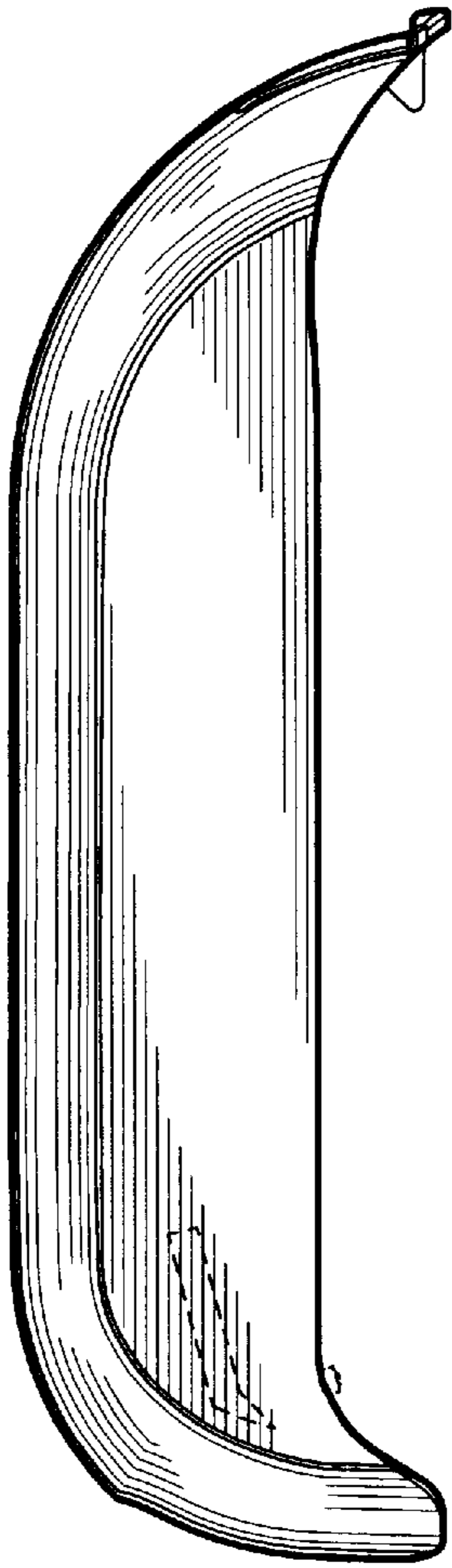

FIG. 2

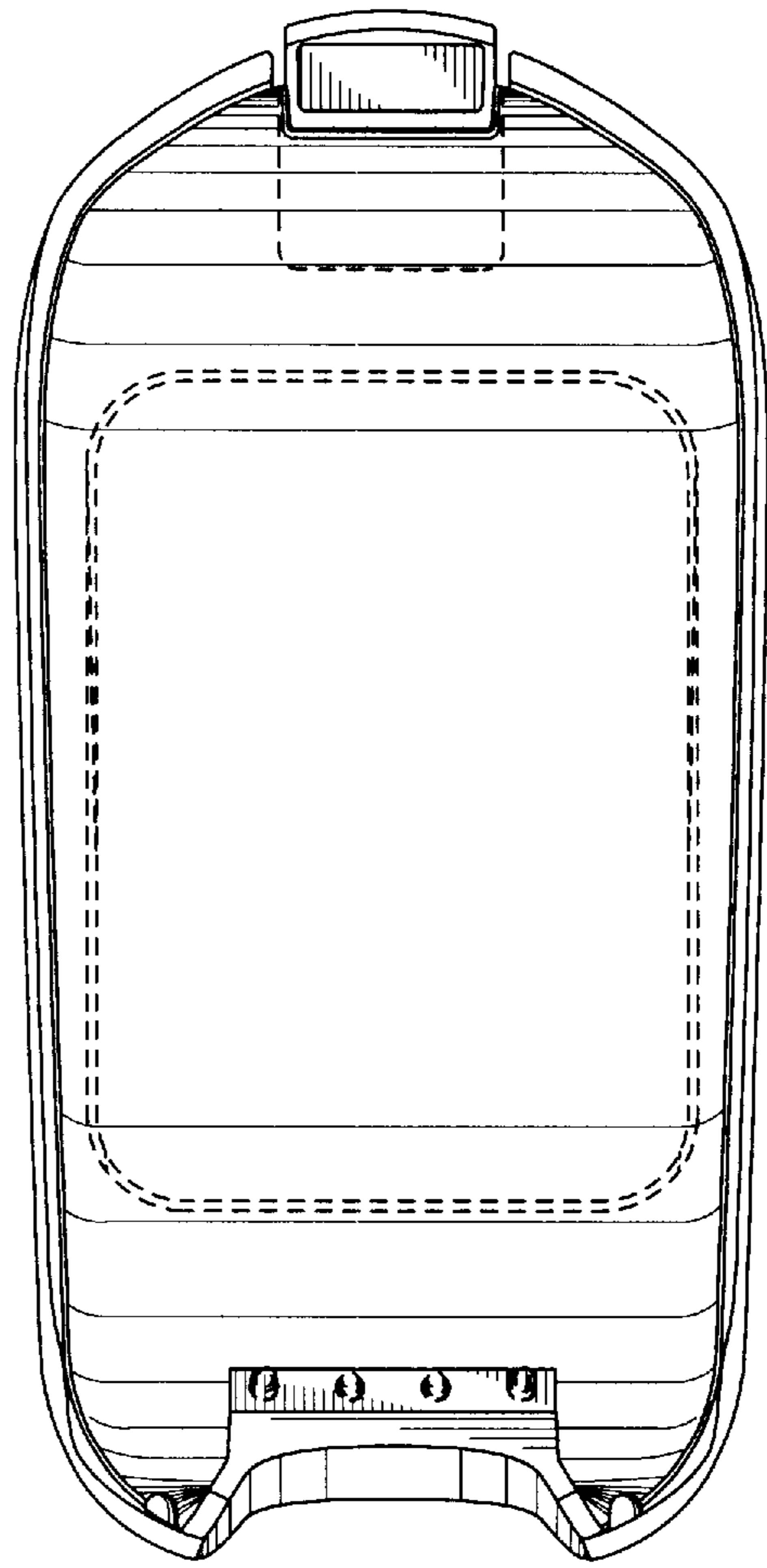

FIG. 3

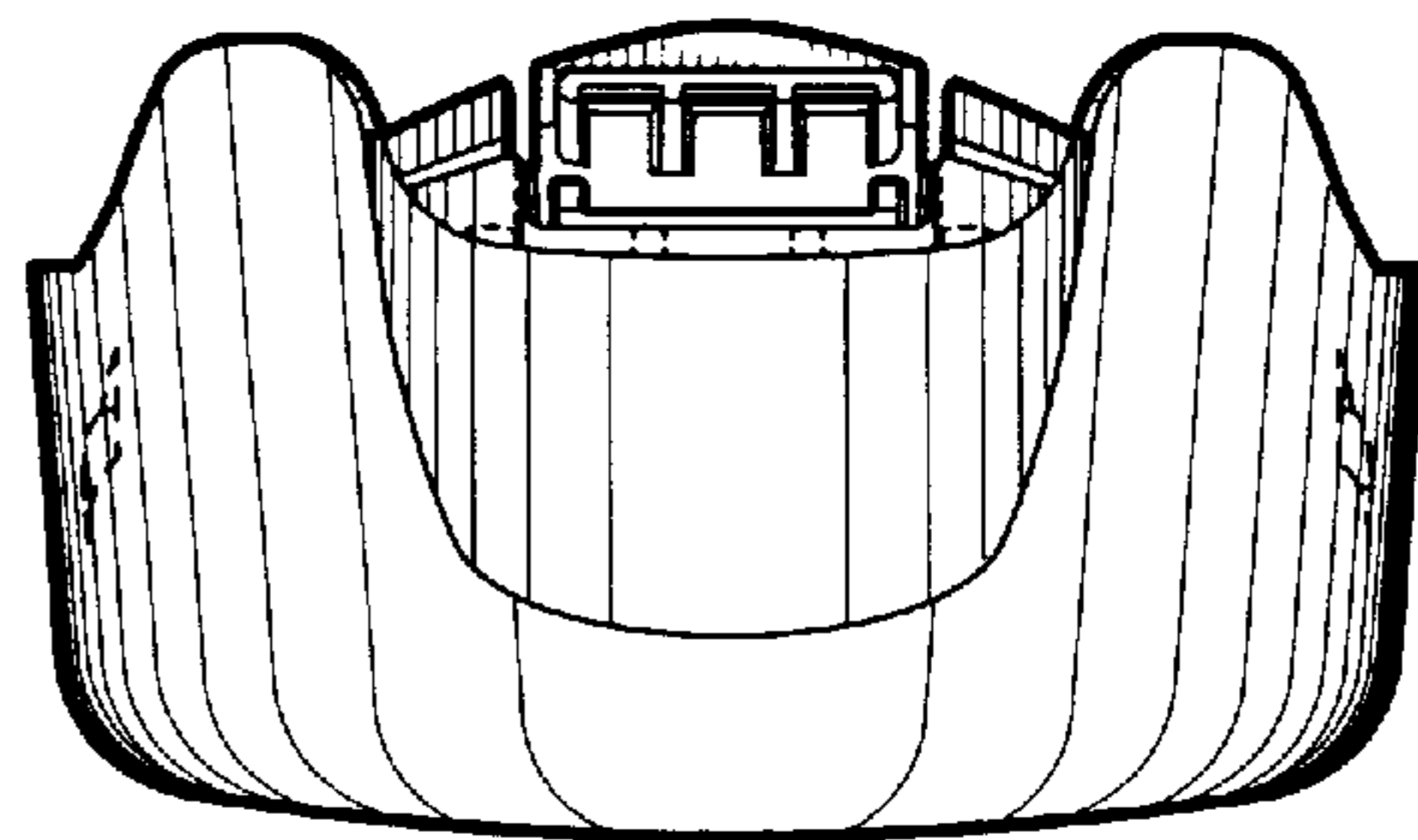

FIG. 4

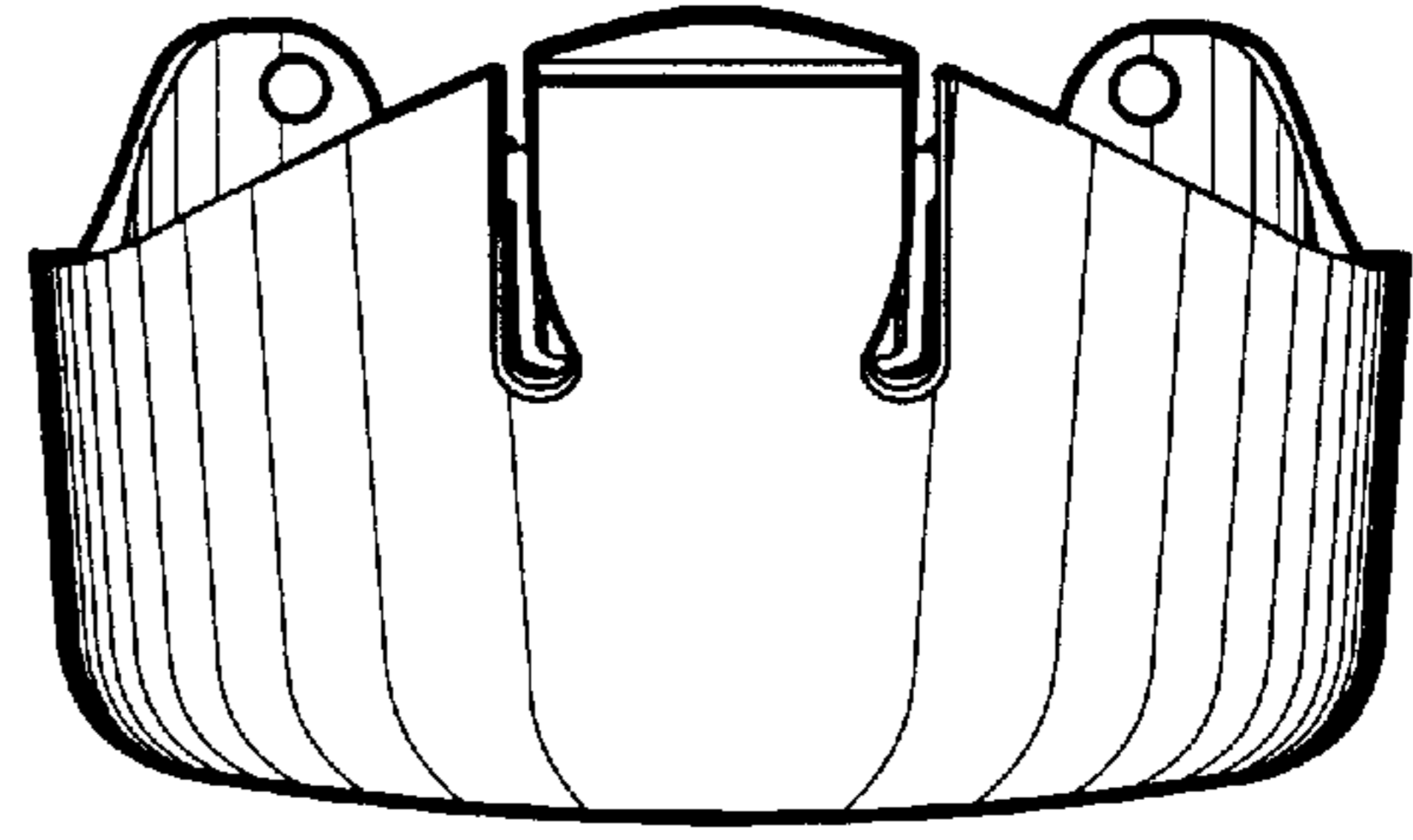

FIG. 5



FIG. 6

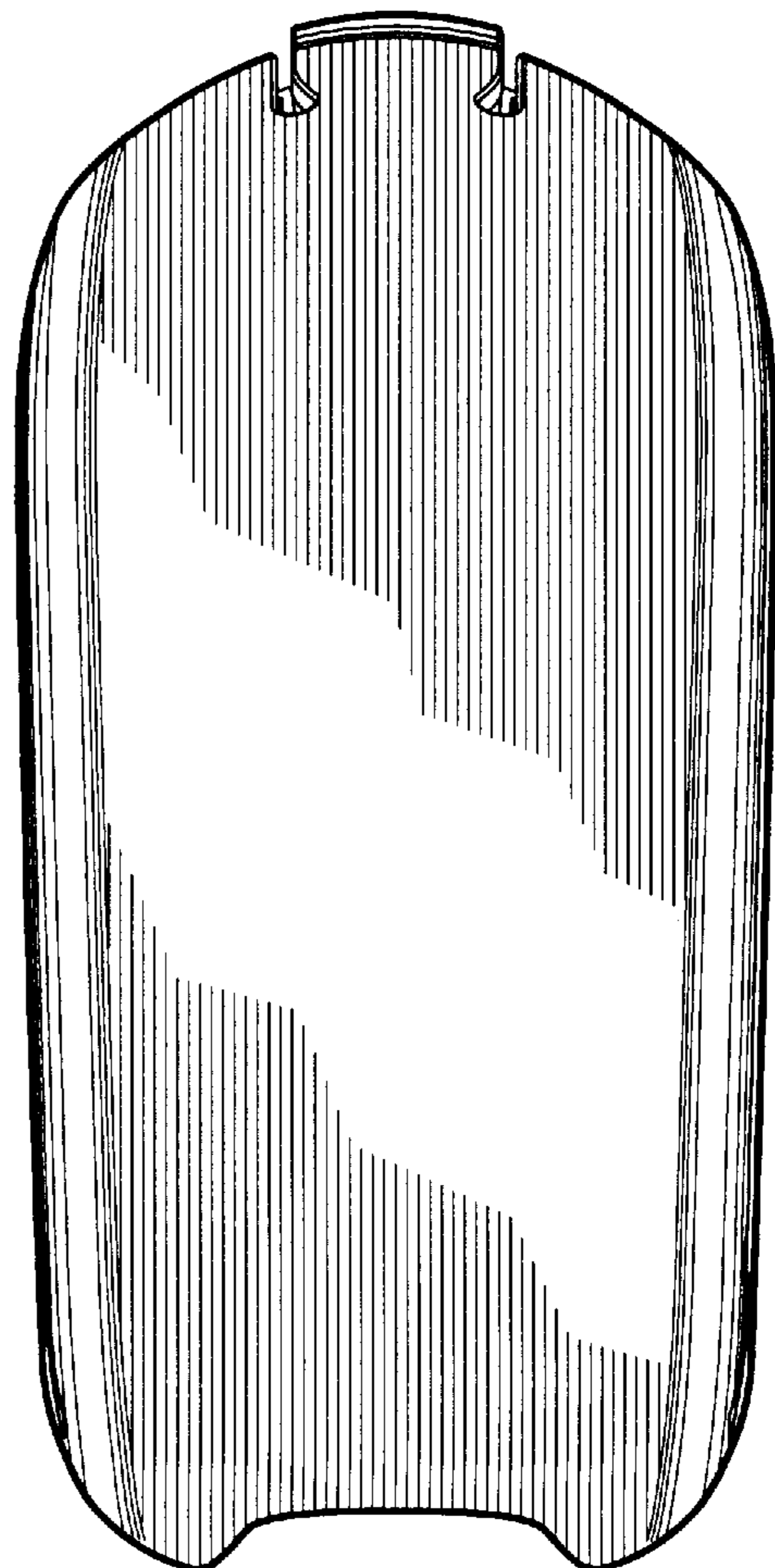

FIG. 7

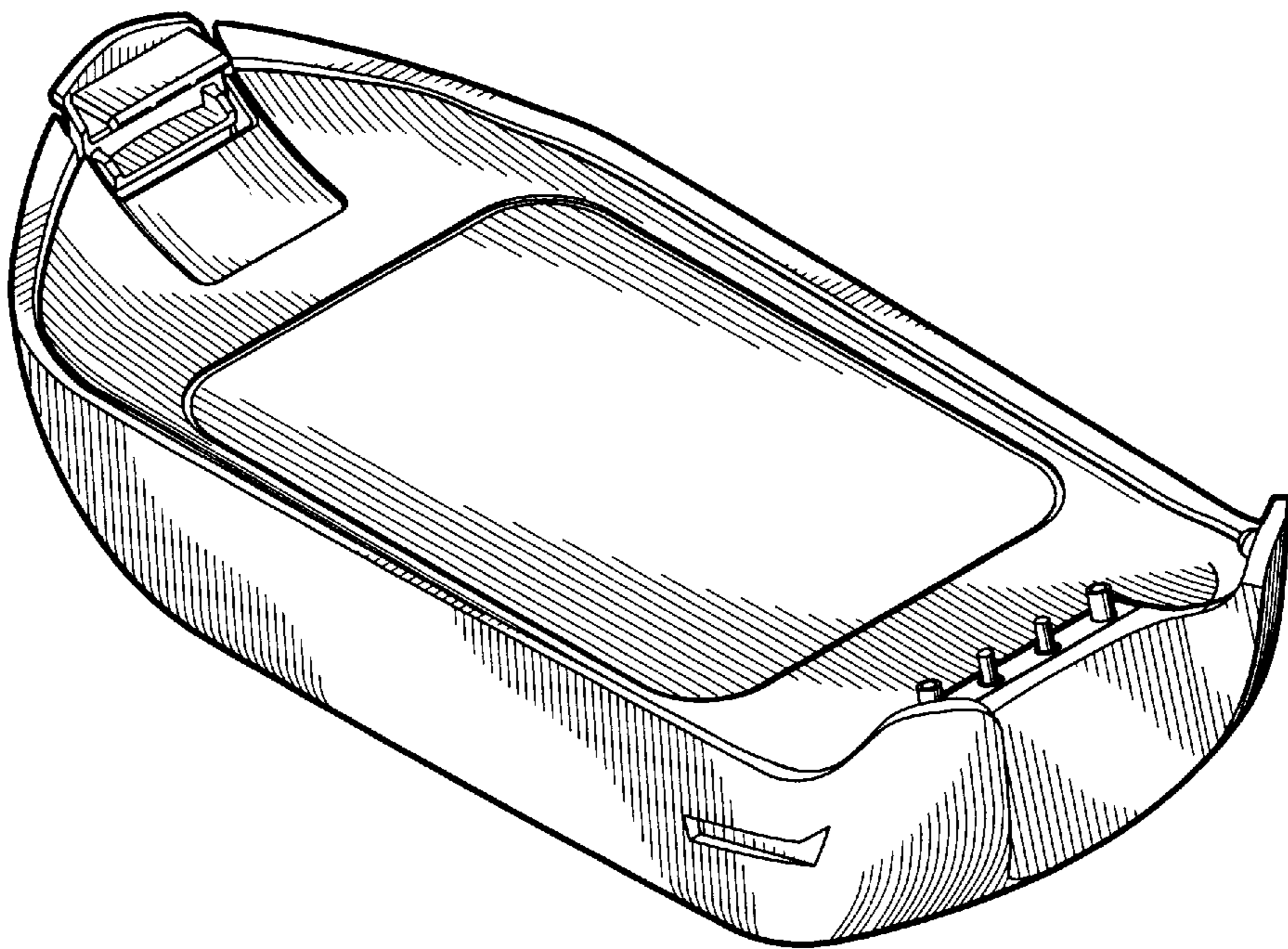

FIG. 8

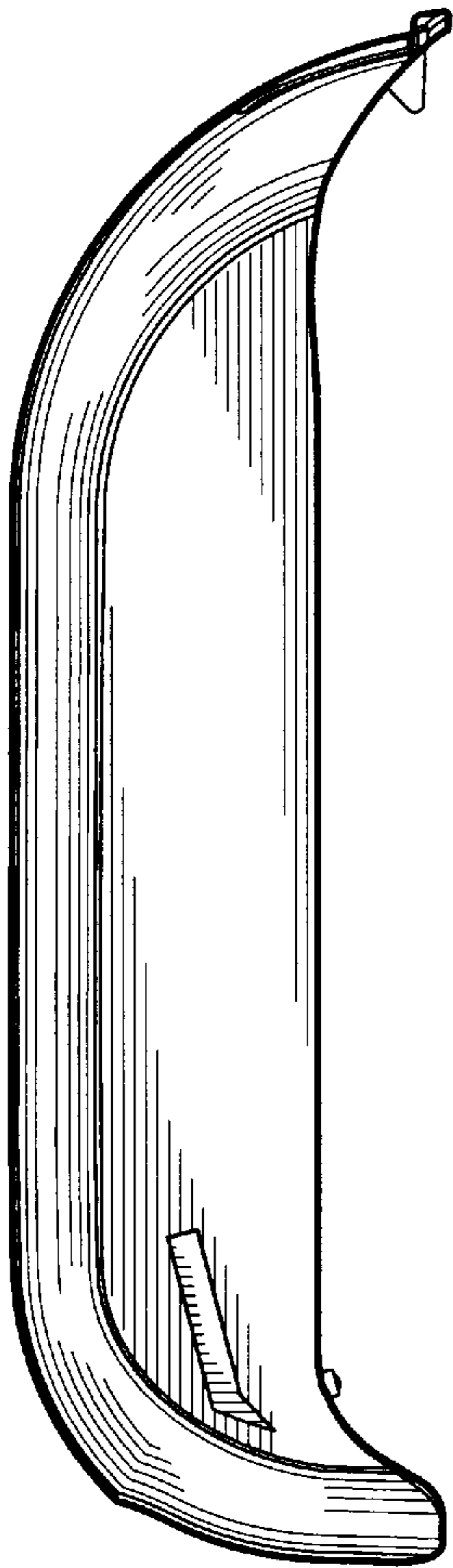

FIG. 9

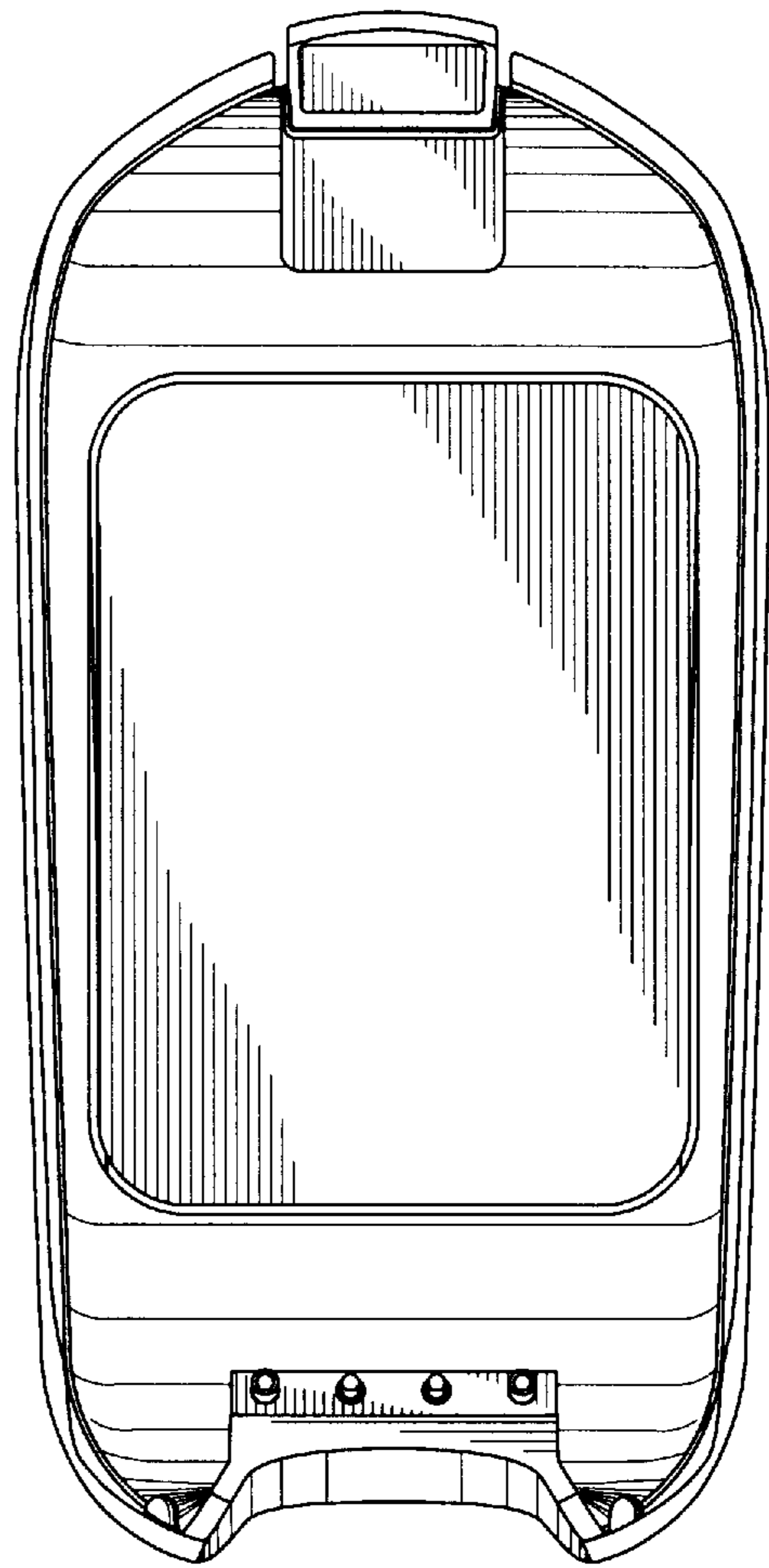

FIG. 10

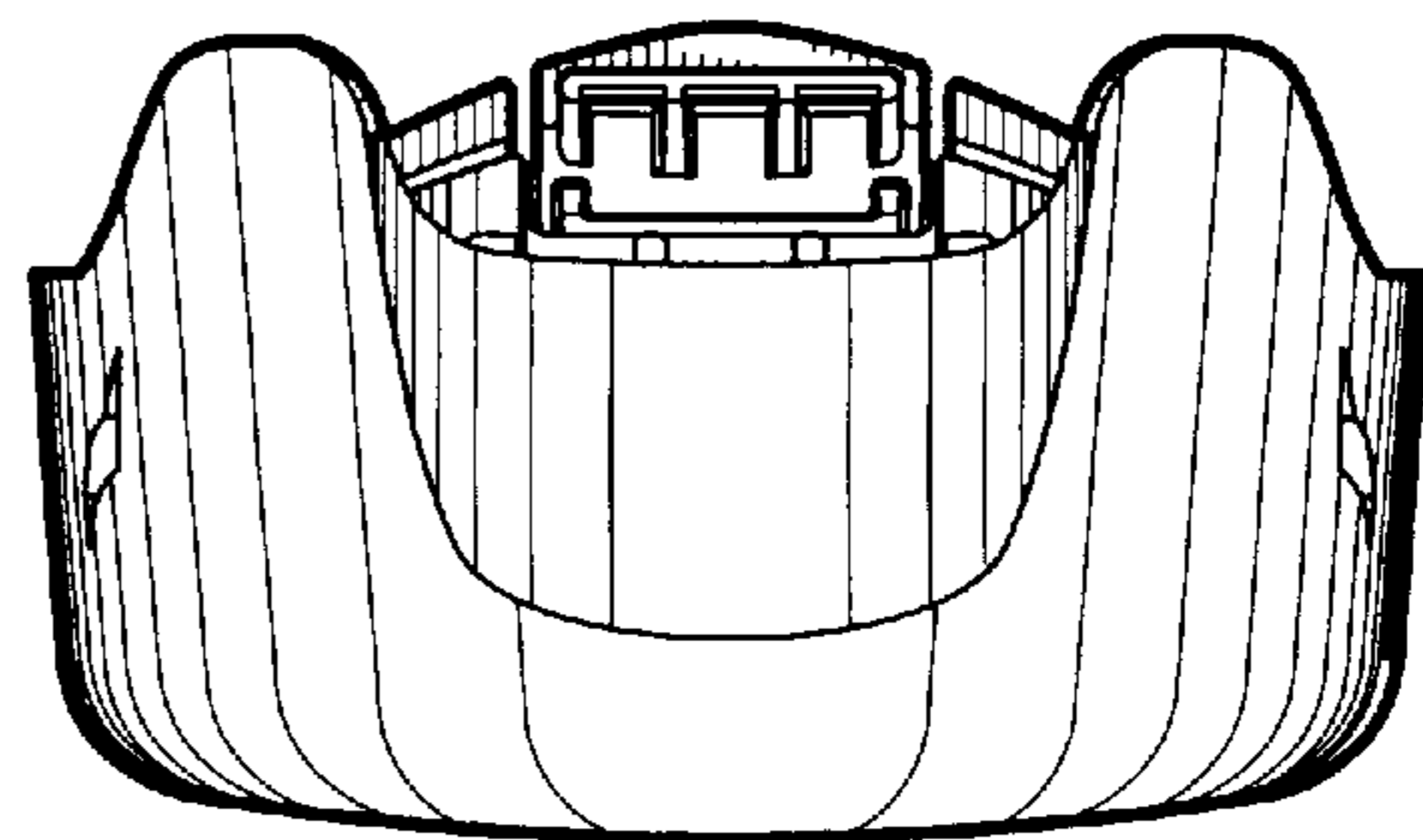

FIG. 11

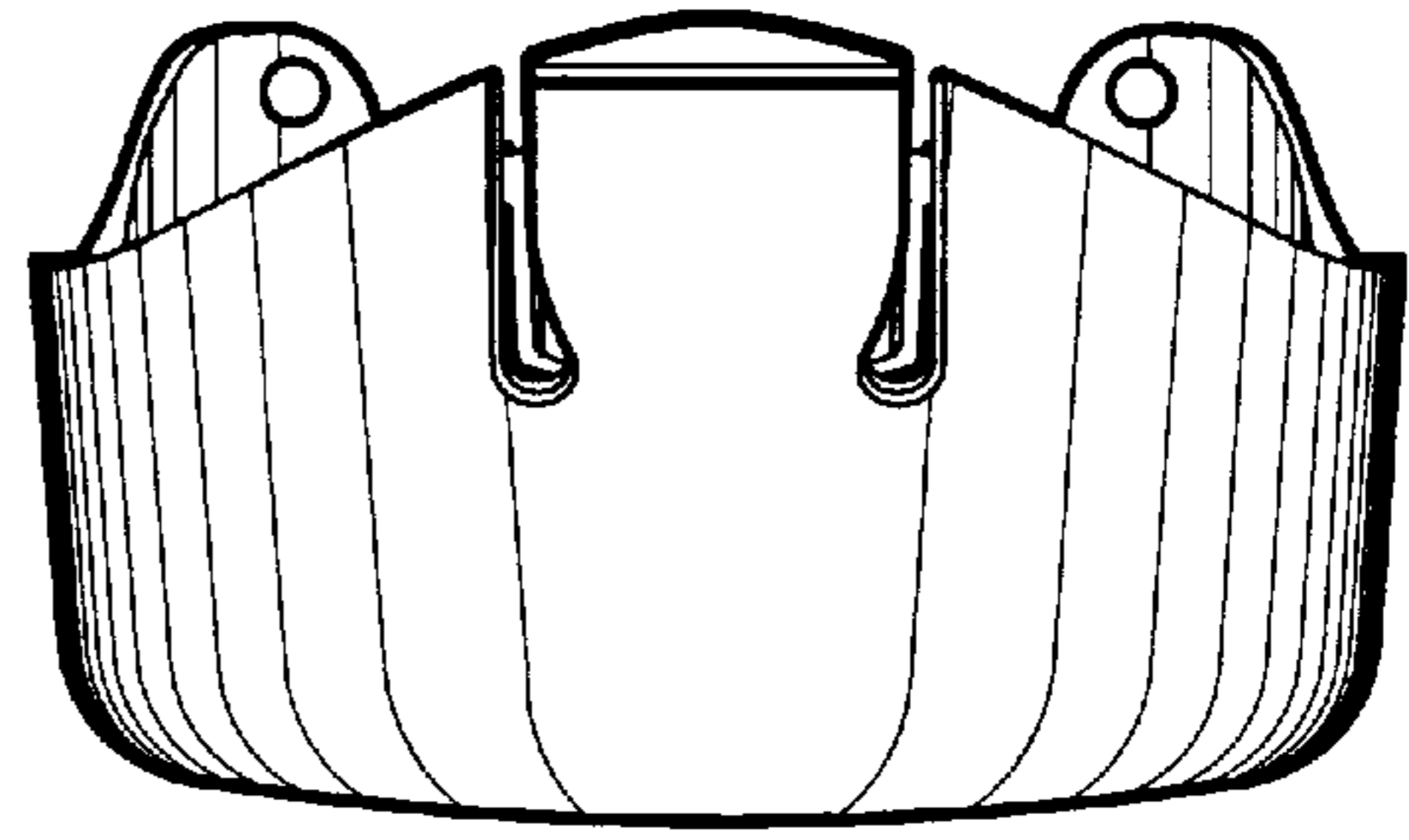

FIG. 12

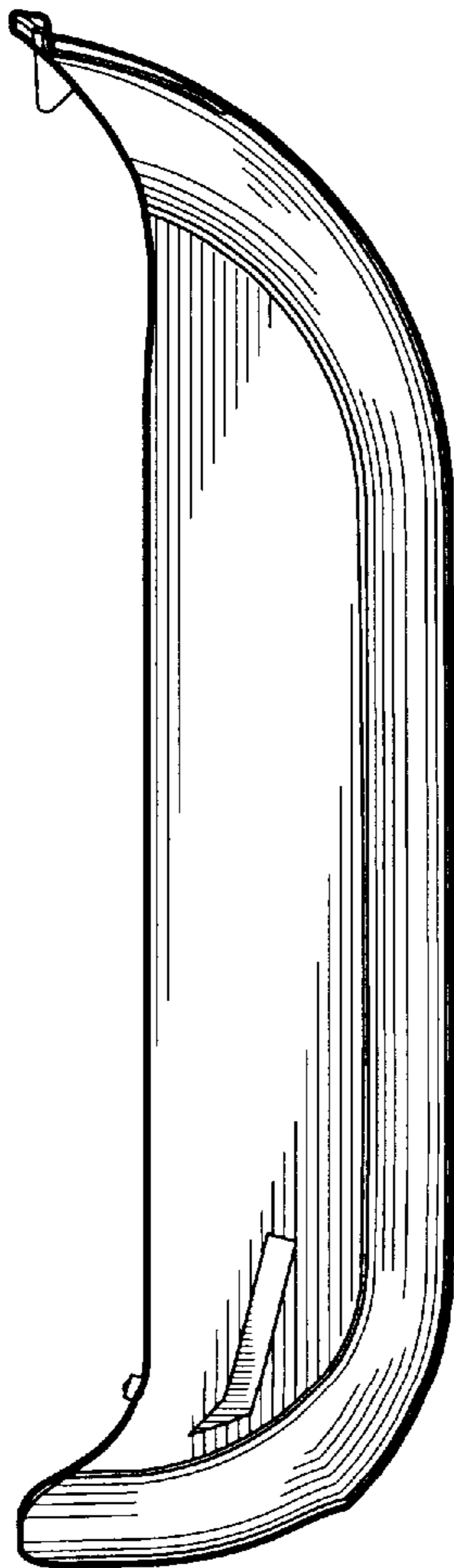

FIG. 13

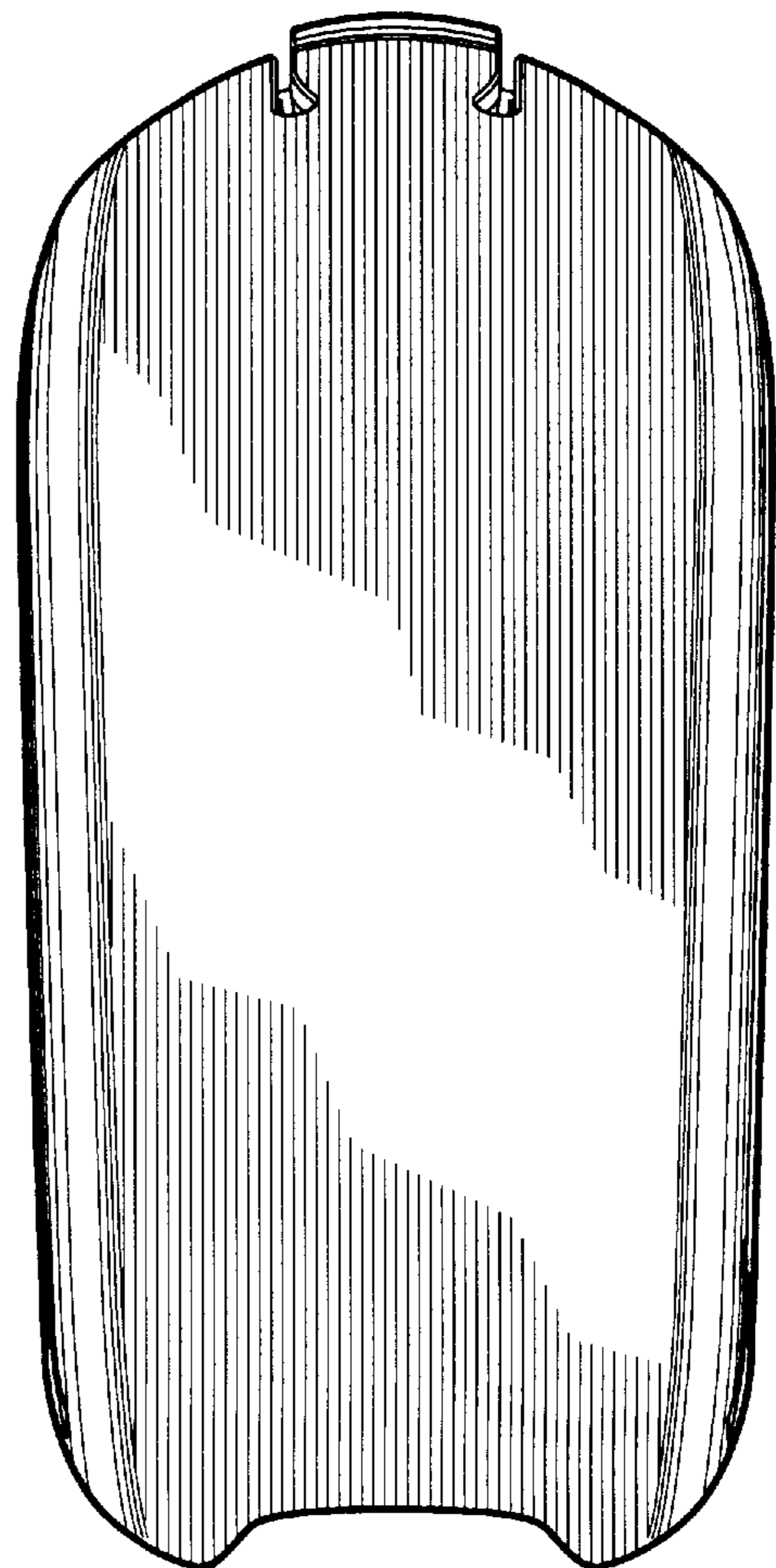

FIG. 14