



US00D407042S

United States Patent [19]
Pierce

[11] **Patent Number: Des. 407,042**

[45] **Date of Patent: **Mar. 23, 1999**

[54] **BACKGROUND PLATE FOR A SPORTS TROPHY**

[75] Inventor: **Ian Pierce**, Orangeville, Canada

[73] Assignee: **Tromar Corporation**, Canada

[**] Term: **14 Years**

[21] Appl. No.: **86,256**

[22] Filed: **Apr. 8, 1998**

Related U.S. Application Data

[62] Division of Ser. No. 60,417, Sep. 26, 1996, Pat. No. Des. 394,231.

[51] **LOC (6) Cl.** **11-02**

[52] **U.S. Cl.** **D11/164**

[58] **Field of Search** D11/131, 164;
428/542.4

[56] **References Cited**

PUBLICATIONS

Trophies, Plaques, Gift Awards Catalog; p. 11; Trophy, May 1962.

Edwin W. Lane Co. Awards Catalog; p. 6; Trophy, Jun. 1964.
Dodge Trophies Inc. Silver Anniversary Catalog; p. 13; Trophy, Nov. 1955.

Dinn Bros. Inc. Trophy Catalog; p. 15; Trophy, Feb. 1992.

Primary Examiner—Dominic Simone
Attorney, Agent, or Firm—Adams & Wilks

[57] **CLAIM**

The ornamental design for a background plate for a sports trophy, as shown and described.

DESCRIPTION

FIG. 1 is a front perspective view of a background plate for a sports trophy showing my new design;
FIG. 2 is a front elevational view thereof;
FIG. 3 is a left side elevational view thereof;
FIG. 4 is a top plan view thereof;
FIG. 5 is a rear elevational view thereof;
FIG. 6 is a right side elevational view thereof; and,
FIG. 7 is a bottom plan view thereof.

1 Claim, 3 Drawing Sheets

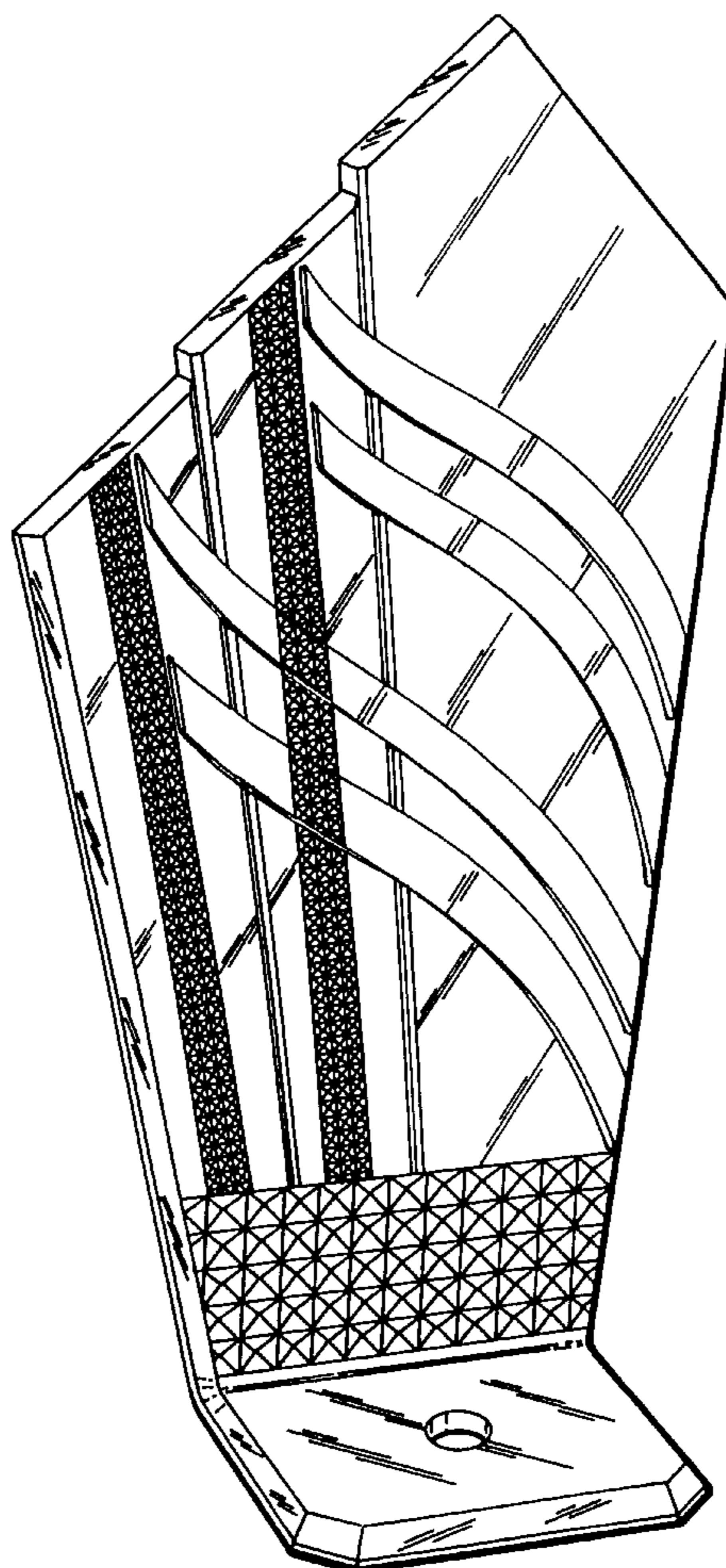

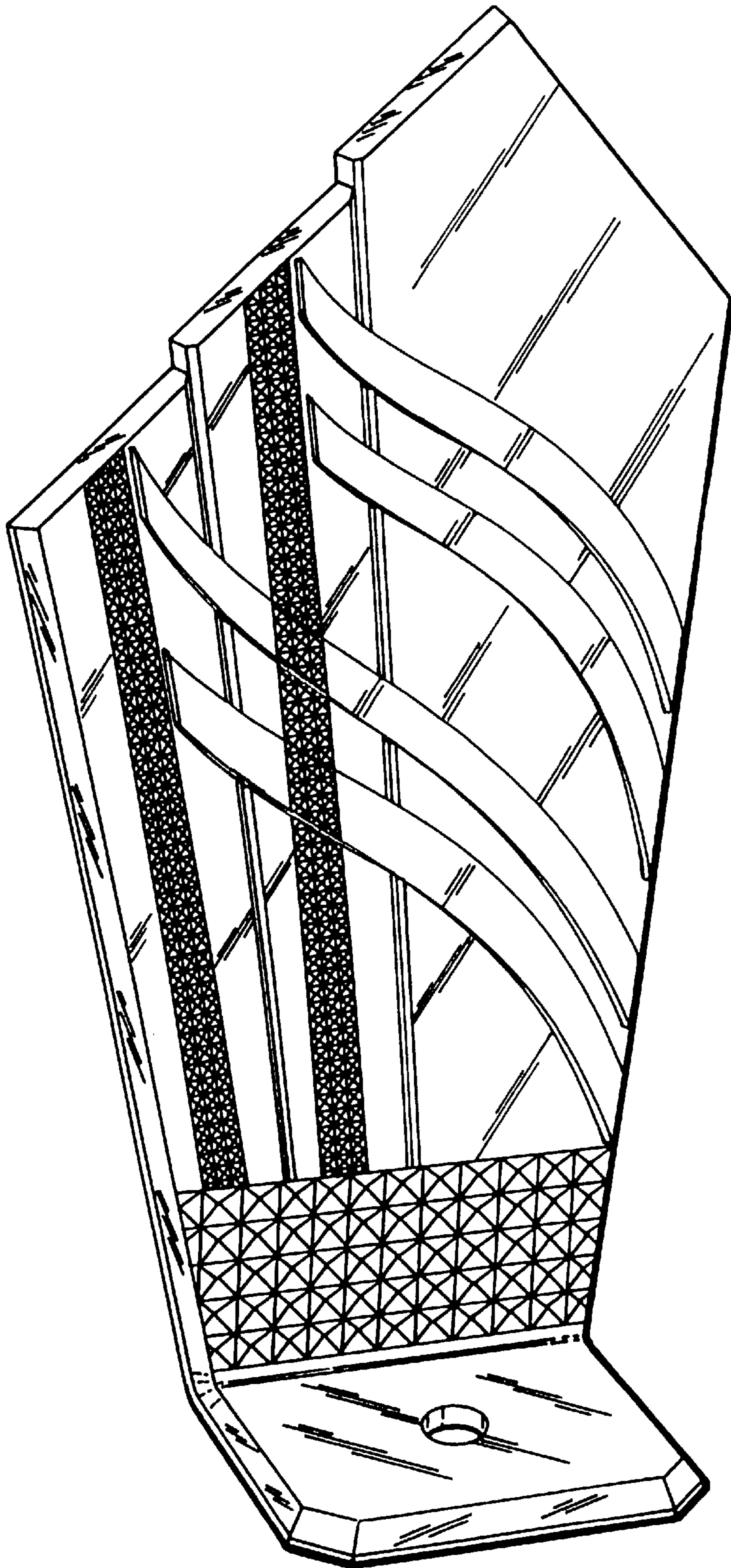

FIG. 1.

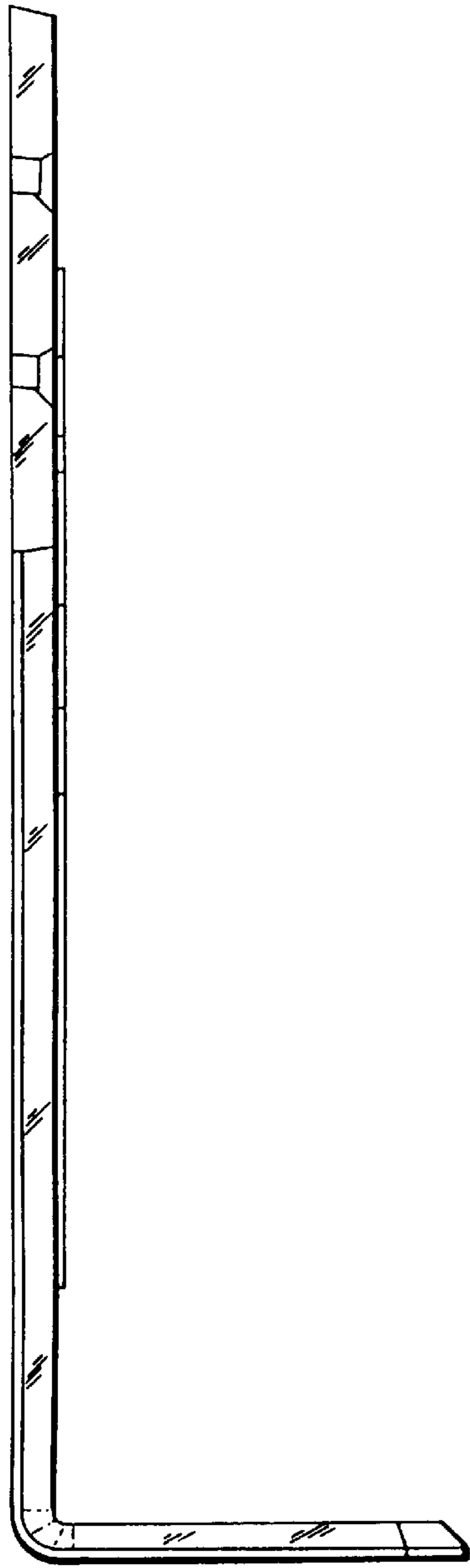

FIG. 3.

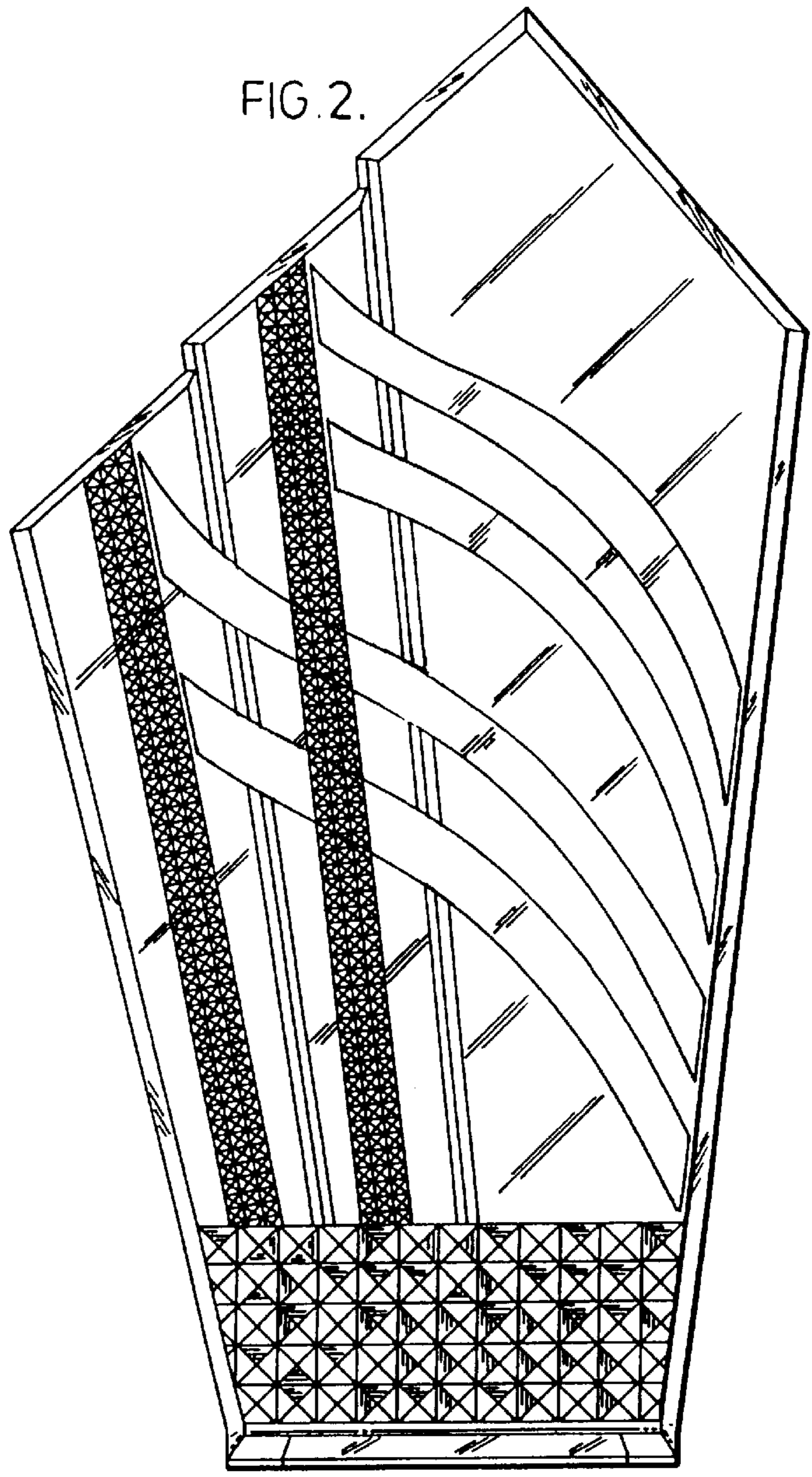

FIG. 2.

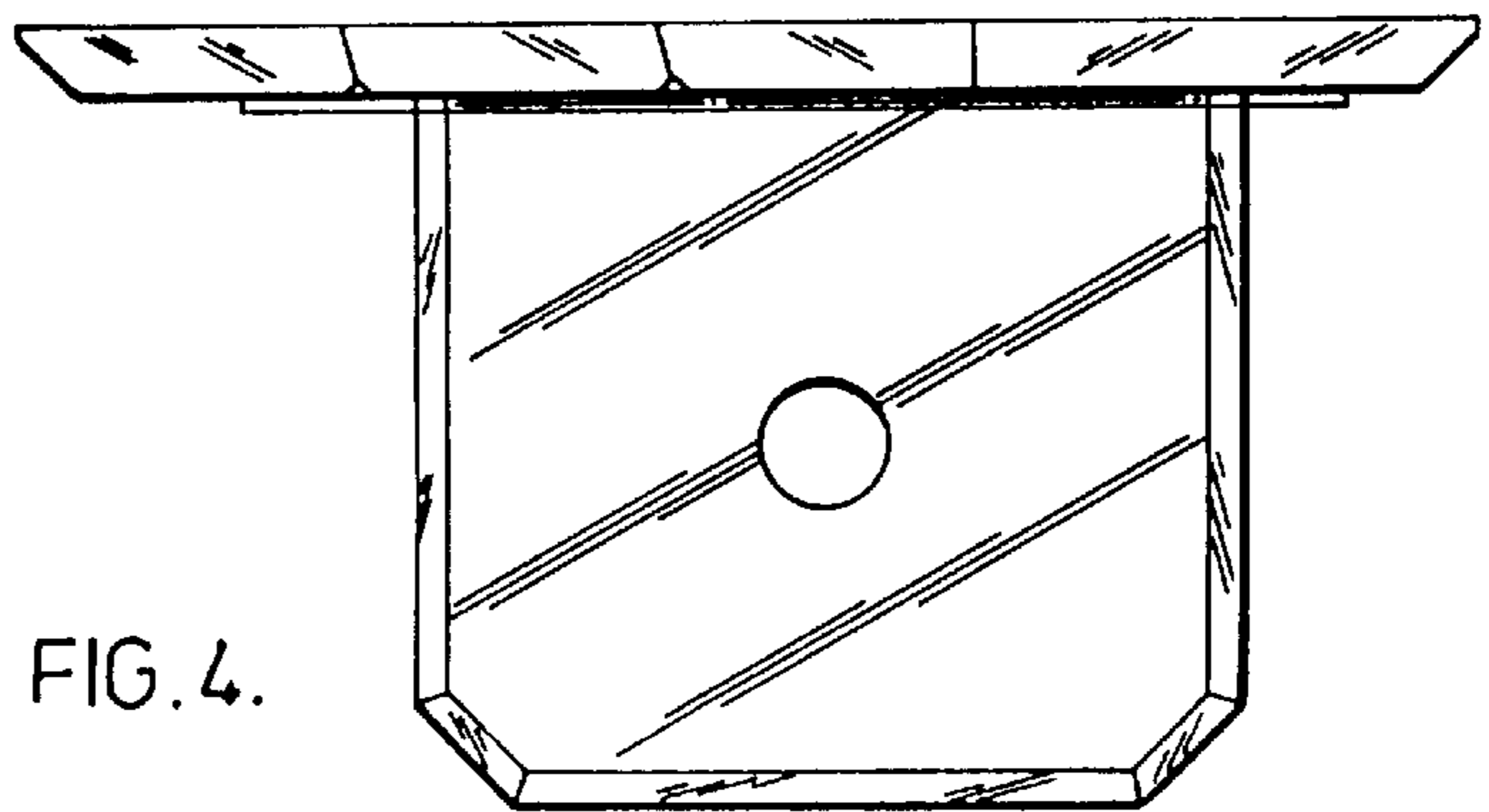

FIG. 4.

FIG. 5.

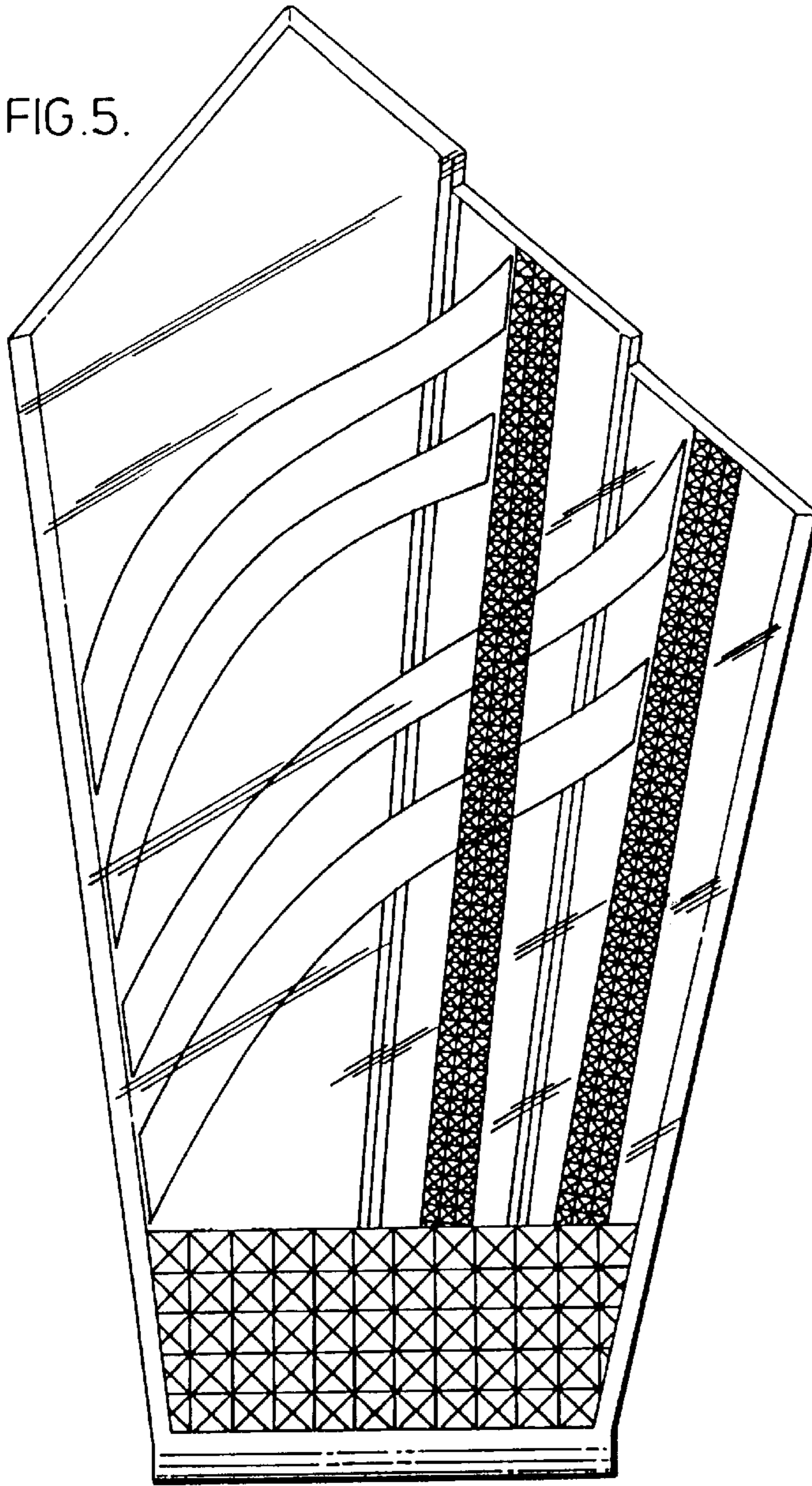

FIG. 6.

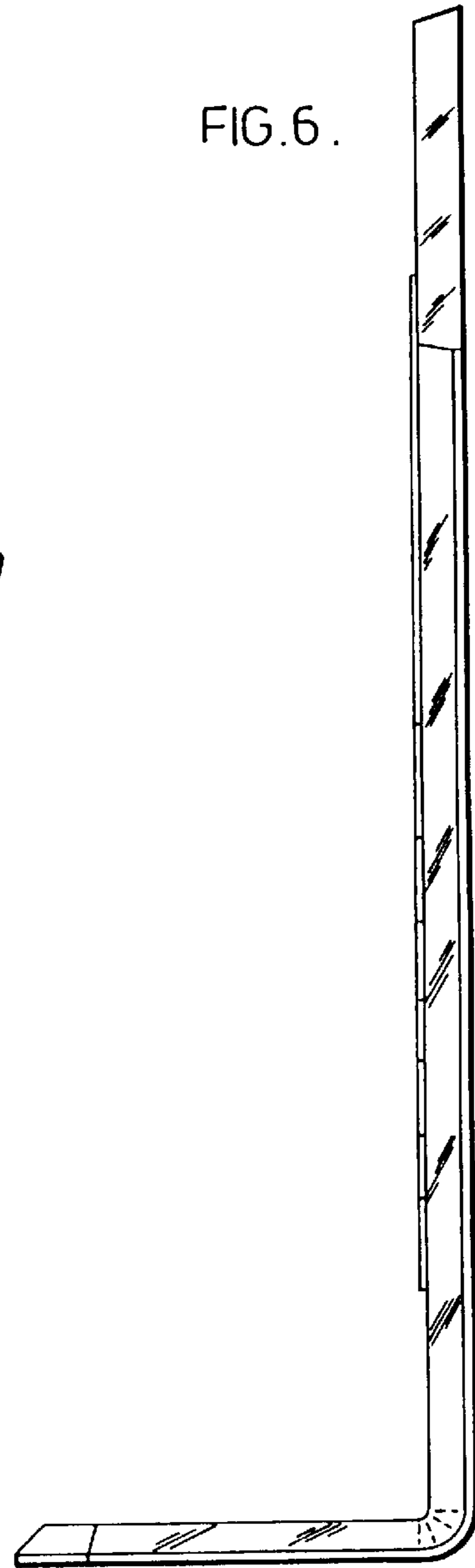

FIG. 7.

