



US00D407016S

United States Patent [19]

Nastasia

[11] **Patent Number: Des. 407,016**

[45] **Date of Patent: **Mar. 23, 1999**

[54] **FERMENTATION BUNG**

[76] Inventor: **Martin A. Nastasia**, 307 Olive Ct., Lodi, Calif. 95240

[**] Term: **14 Years**

[21] Appl. No.: **74,698**

[22] Filed: **Aug. 1, 1997**

[51] **LOC (6) Cl.** **09-07**

[52] **U.S. Cl.** **D9/439; D9/454**

[58] **Field of Search** D9/434, 435, 436, D9/439, 454, 503, 504, 529, 544, 545; 215/296, 307-309, 355, 364; 220/254-256, 285, 286, DIG. 19

[56] **References Cited**

U.S. PATENT DOCUMENTS

| | | | | | |
|-----------|---------|-------|-------|---------|---|
| 2,186,457 | 1/1940 | Juffa | | 215/309 | X |
| 3,220,555 | 11/1965 | Silha | | 215/308 | X |
| 3,326,401 | 6/1967 | Long | | 215/308 | |

| | | | | | |
|-----------|---------|-----------|-------|---------|---|
| 3,628,681 | 12/1971 | Schwartz | | 215/364 | |
| 5,636,757 | 6/1997 | Porvaznik | | 215/364 | |
| 5,722,548 | 3/1998 | Hojnoski | | 215/296 | X |

Primary Examiner—James Gandy
Assistant Examiner—Cathron B. Matta
Attorney, Agent, or Firm—Basil Travis

[57] **CLAIM**

The ornamental design for a fermentation bung, as shown and described.

DESCRIPTION

FIG. 1 is a top and side perspective view of a fermentation bung showing my new design;
FIG. 2 is a top plan view thereof;
FIG. 3 is a side elevational view thereof, the opposite side being a mirror image thereof;
FIG. 4 is a bottom plan view thereof;
FIG. 5 is a view taken about lines 5—5 of FIG. 3; and,
FIG. 6 is a view taken along lines 6—6 of FIG. 3.

1 Claim, 1 Drawing Sheet

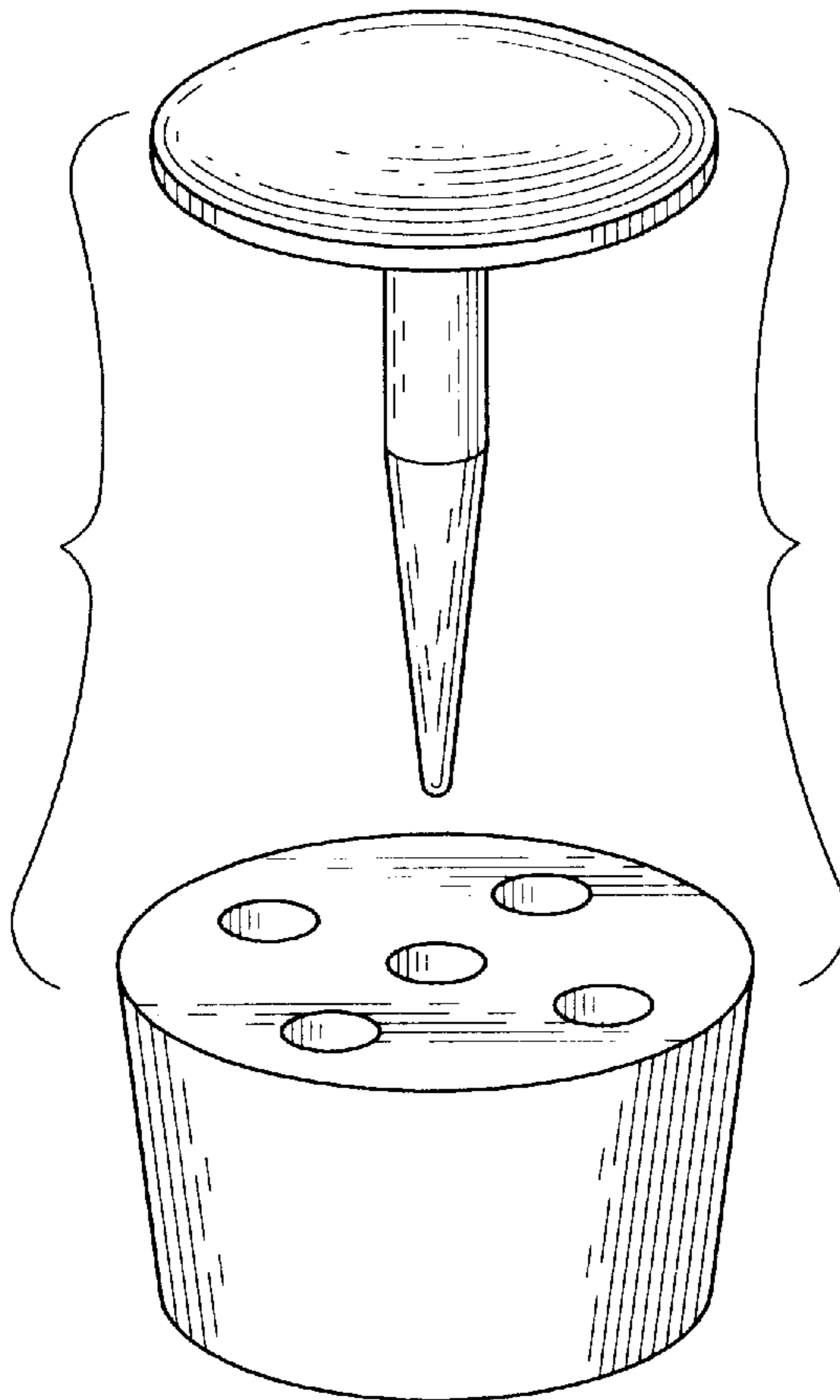

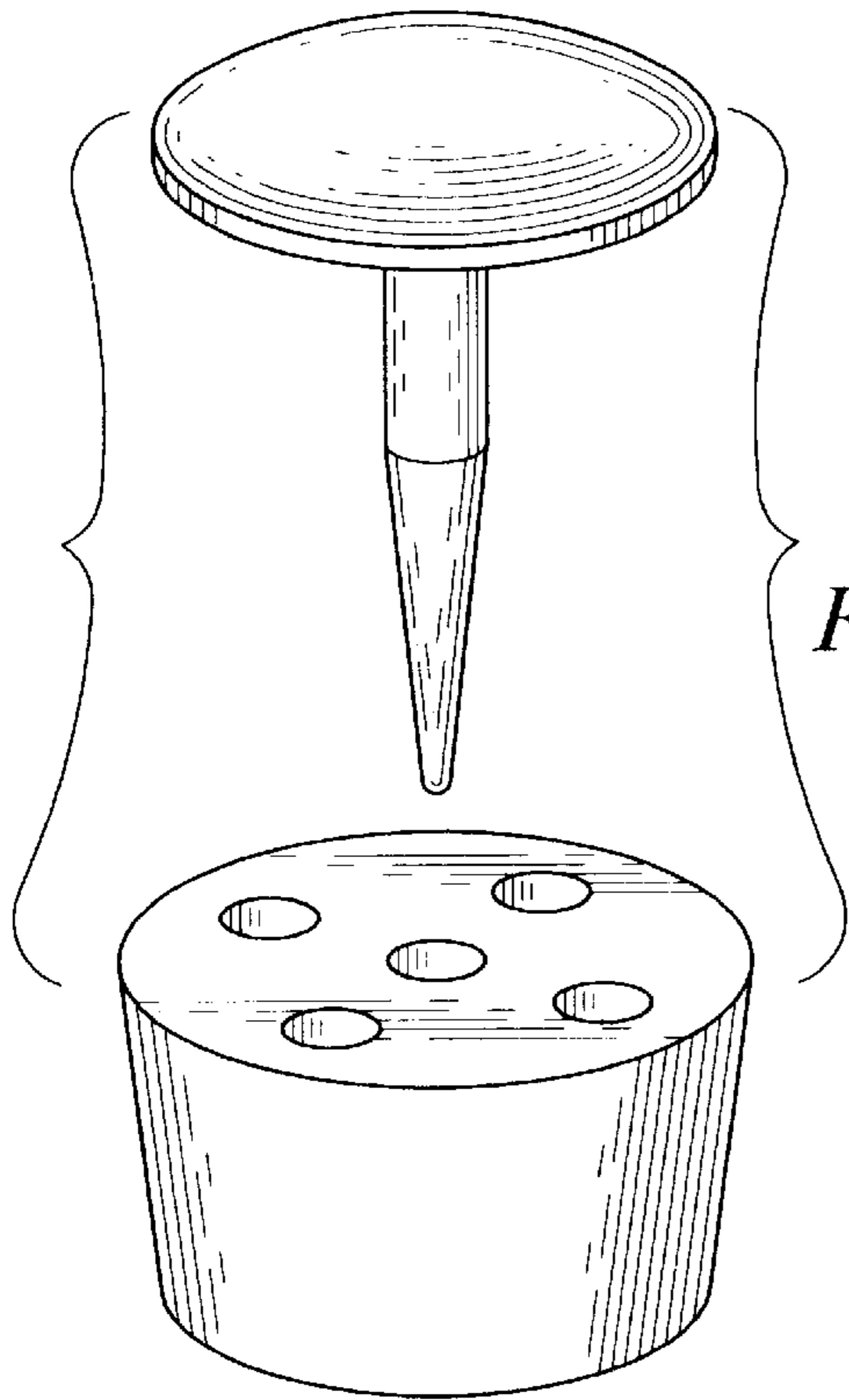

Fig. 1

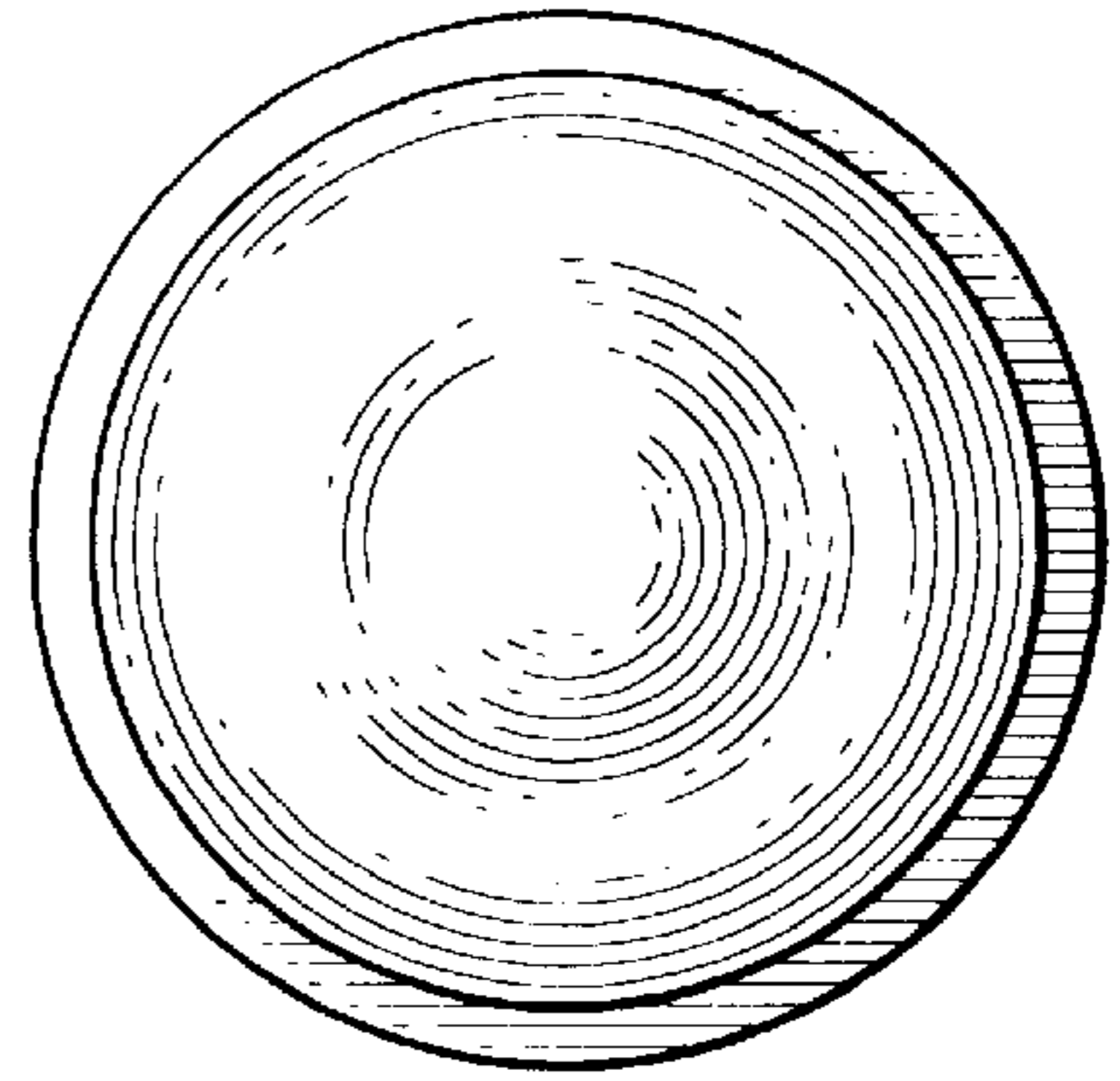

Fig. 2

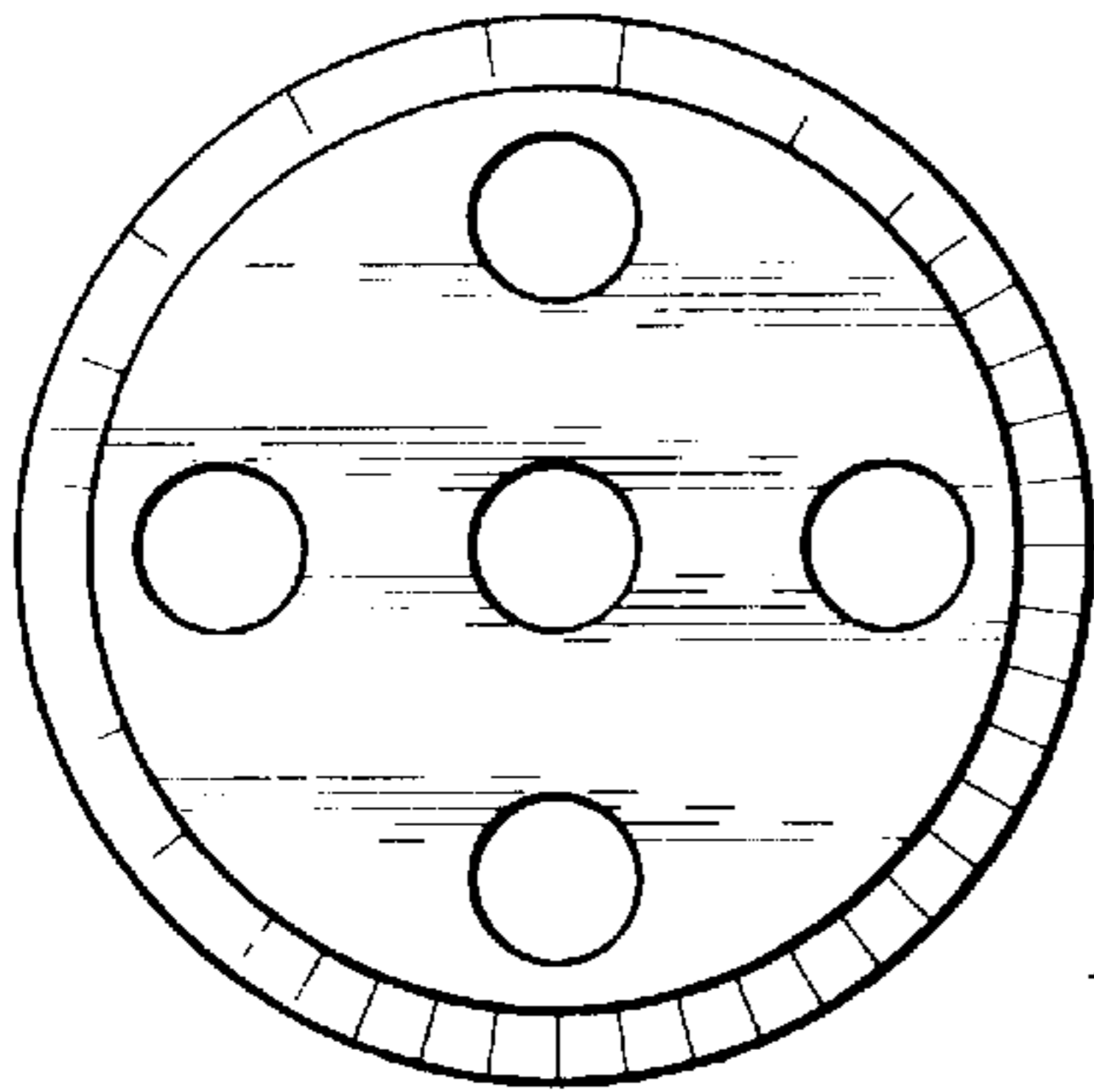

Fig. 4

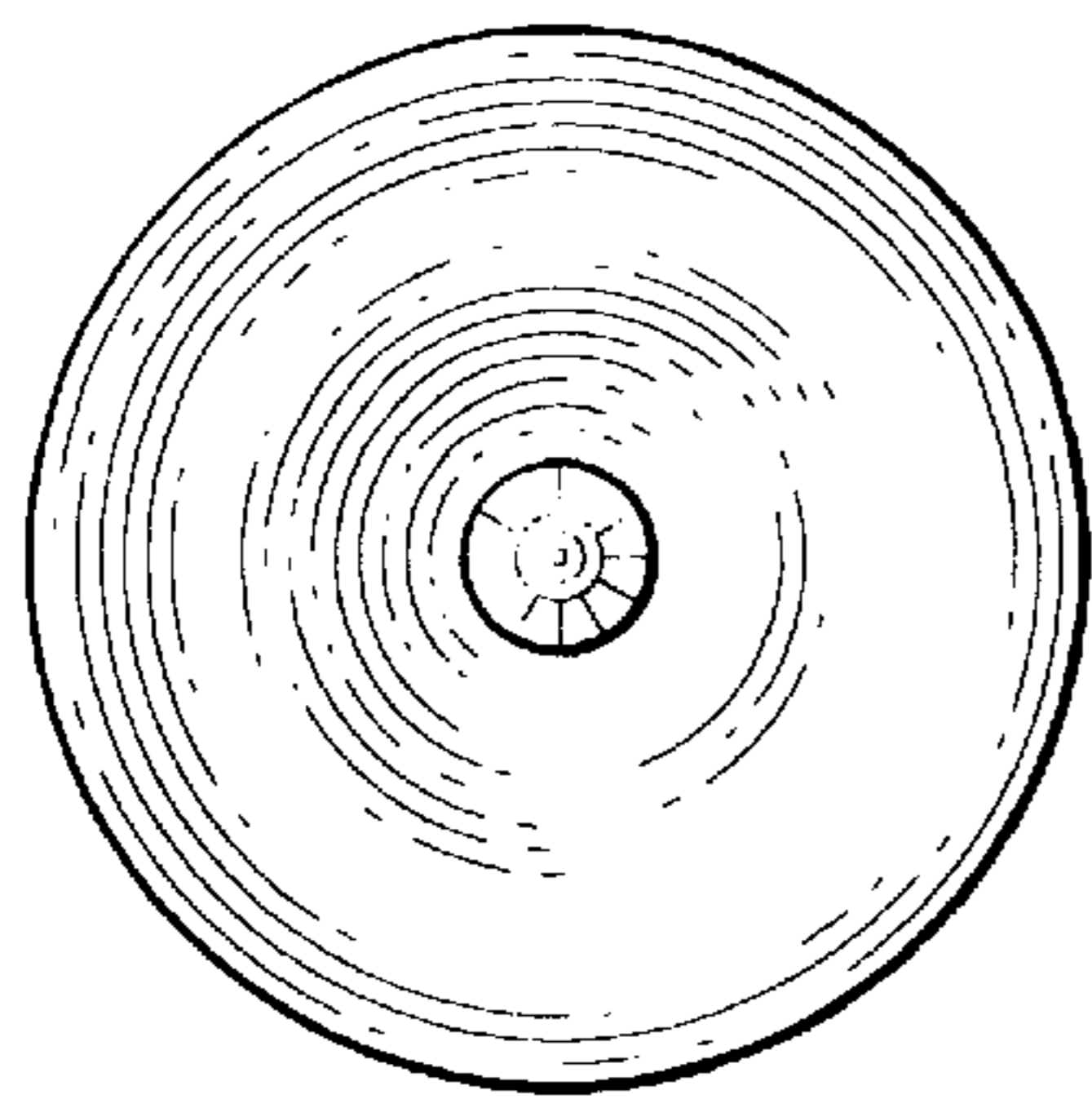
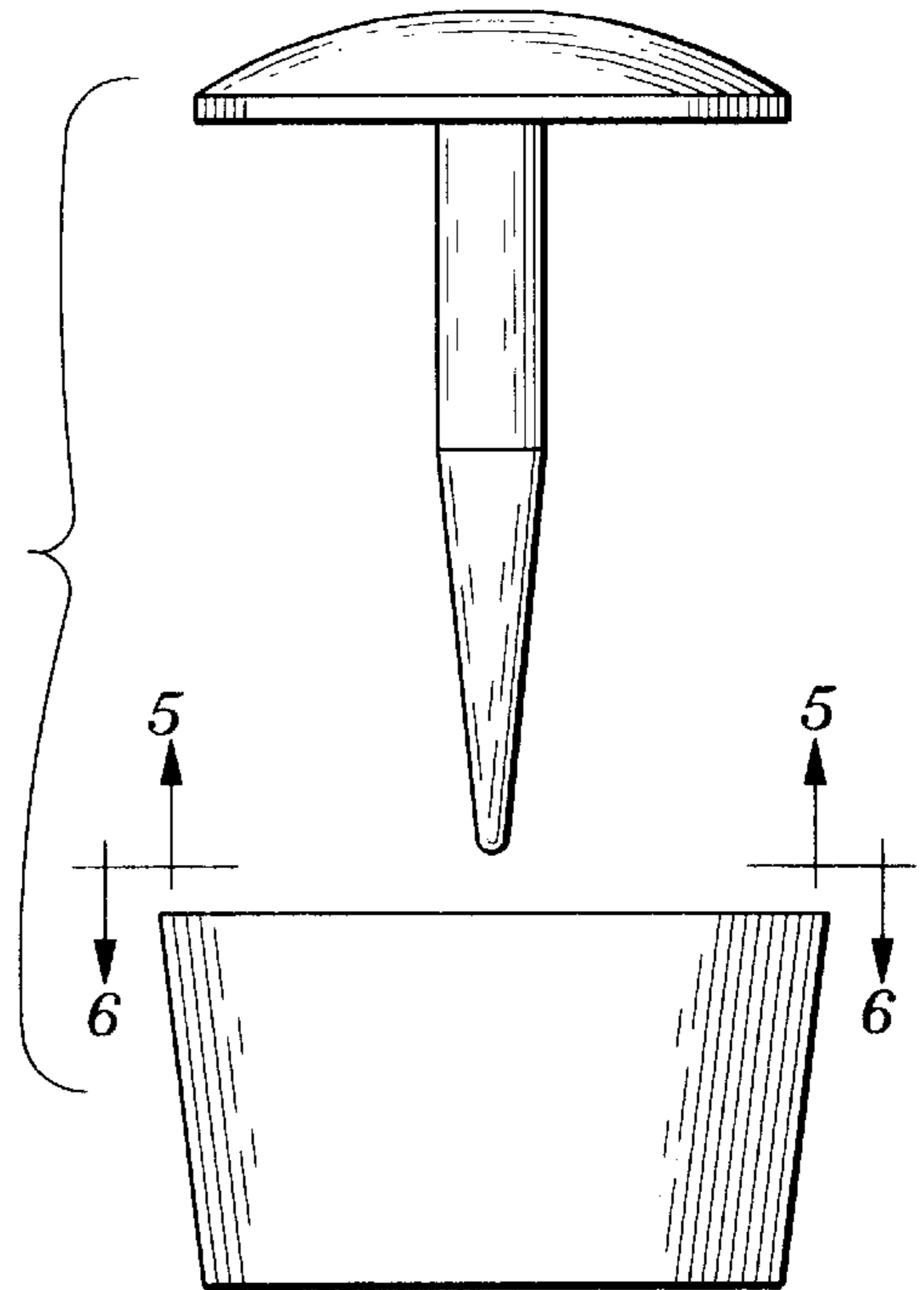

Fig. 5

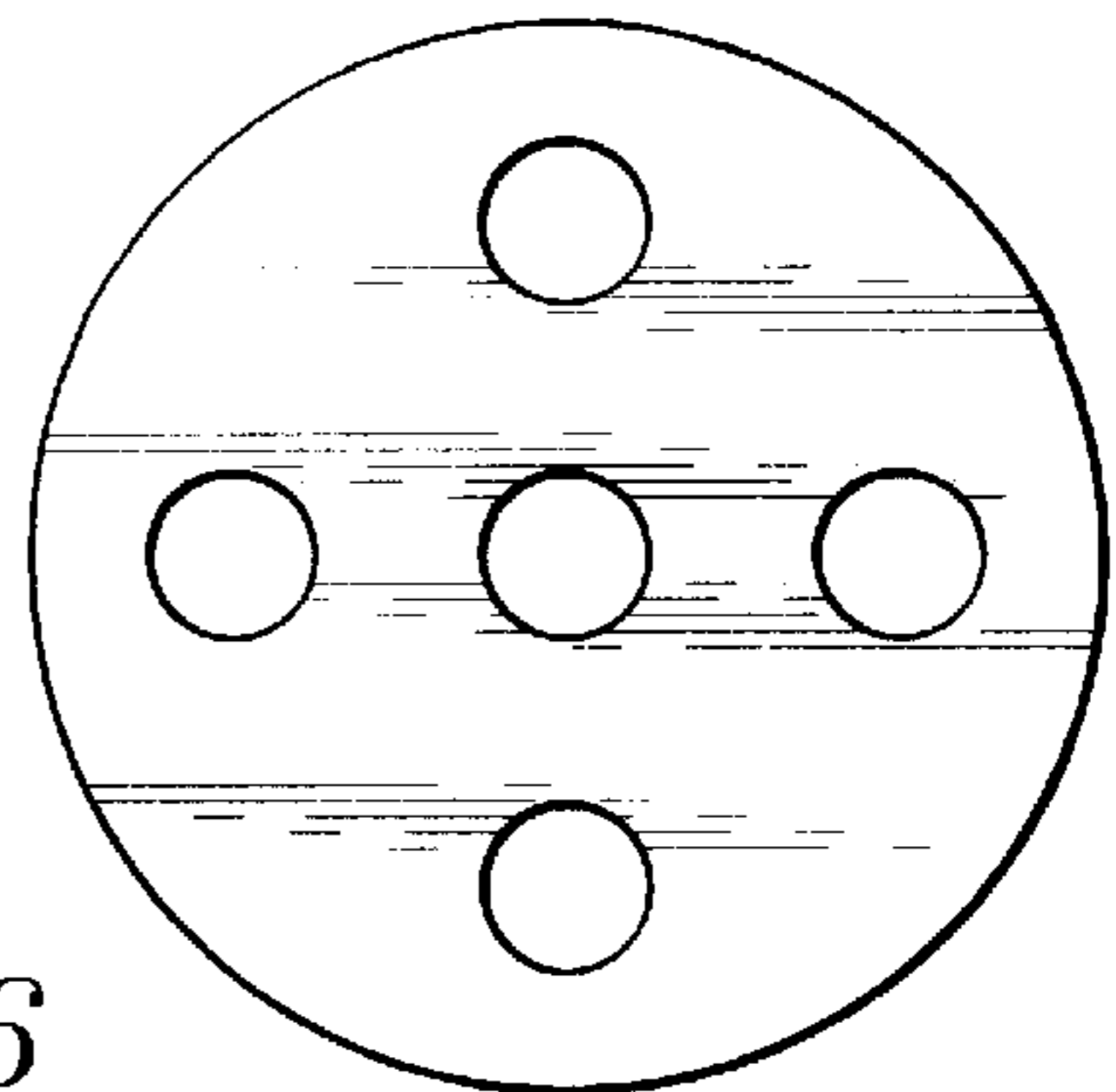

Fig. 6