



US00D406914S

United States Patent [19] Yuen

[11] **Patent Number: Des. 406,914**

[45] **Date of Patent: **Mar. 16, 1999**

[54] **RECHARGEABLE EMERGENCY LIGHT**

[75] Inventor: **John Se-Kit Yuen**, Kowloon, Hong Kong

[73] Assignee: **John Manufacturing Limited**, Kowloon, Hong Kong

[**] Term: **14 Years**

[21] Appl. No.: **85,903**

[22] Filed: **Apr. 1, 1998**

[51] **LOC (6) Cl.** **26-02**

[52] **U.S. Cl.** **D26/44**

[58] **Field of Search** D26/37-50; 362/157, 362/158, 183-191, 194-205

[56] **References Cited**

U.S. PATENT DOCUMENTS

D. 324,110	2/1992	Yuen	D26/44
D. 328,144	7/1992	Yuen	D26/44
D. 344,358	2/1994	Yuen	D26/44
D. 349,776	8/1994	Yuen	D26/44

FOREIGN PATENT DOCUMENTS

2002423	11/1989	United Kingdom .
2009307	8/1990	United Kingdom .
2012736	1/1991	United Kingdom .
2030400	4/1993	United Kingdom .

Primary Examiner—Marcus A. Jackson
Attorney, Agent, or Firm—Fay, Sharpe, Beall, Fagan, Minnich & McKee

[57] **CLAIM**

The ornamental design for a rechargeable emergency light, as shown and described.

DESCRIPTION

FIG. 1 is a front elevational view of a rechargeable emergency light showing my new design;
 FIG. 2 is a left side elevational view thereof;
 FIG. 3 is a rear elevational view thereof;
 FIG. 4 is a right side elevational view thereof;
 FIG. 5 is an underneath plan view thereof;
 FIG. 6 is a top plan view thereof;
 FIG. 7 is a front elevational view showing the spotlight in an alternative position thereof;
 FIG. 8 is a right side elevational view showing the spotlight and plug pins in alternative positions thereof;
 FIG. 9 is a rear elevational view showing the spotlight and plug pins in alternative positions thereof;
 FIG. 10 is a left side elevational view showing the spotlight and plug pins in alternative positions thereof;
 FIG. 11 is an underneath plan view showing the spotlight and plug pins in alternative positions thereof; and,
 FIG. 12 is a top plan view showing the spotlight and plug pins in alternative positions thereof.

1 Claim, 4 Drawing Sheets

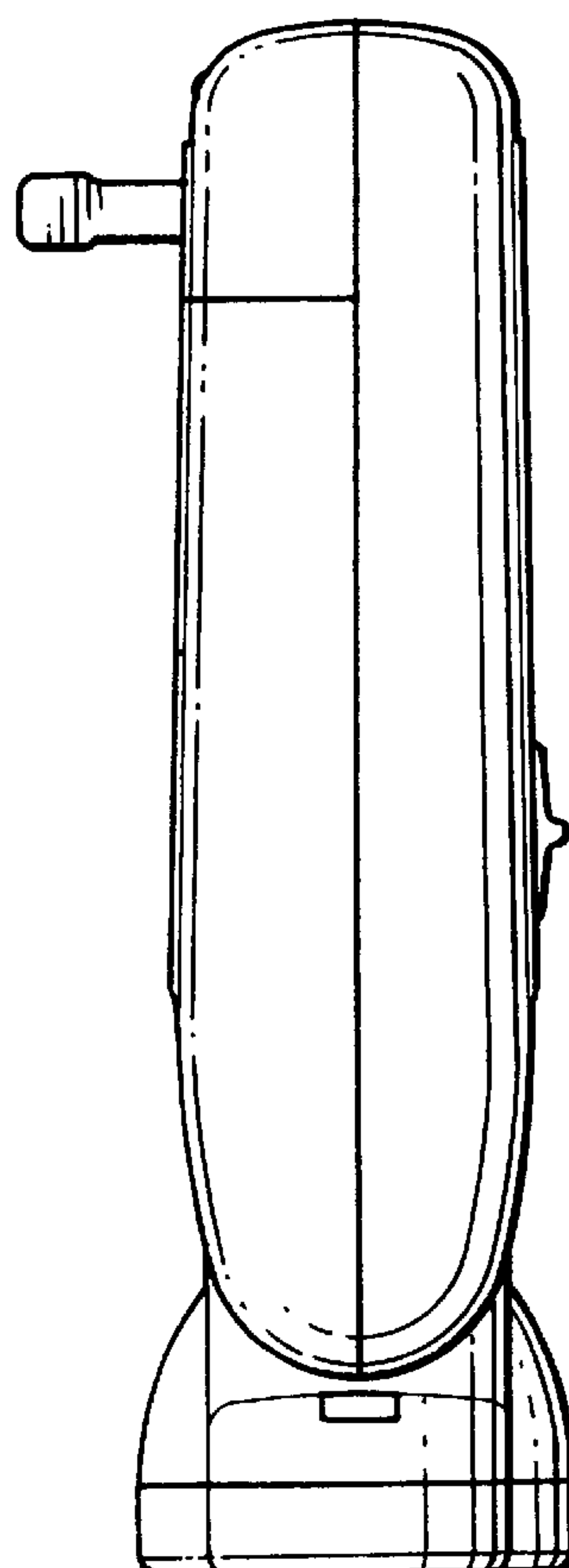
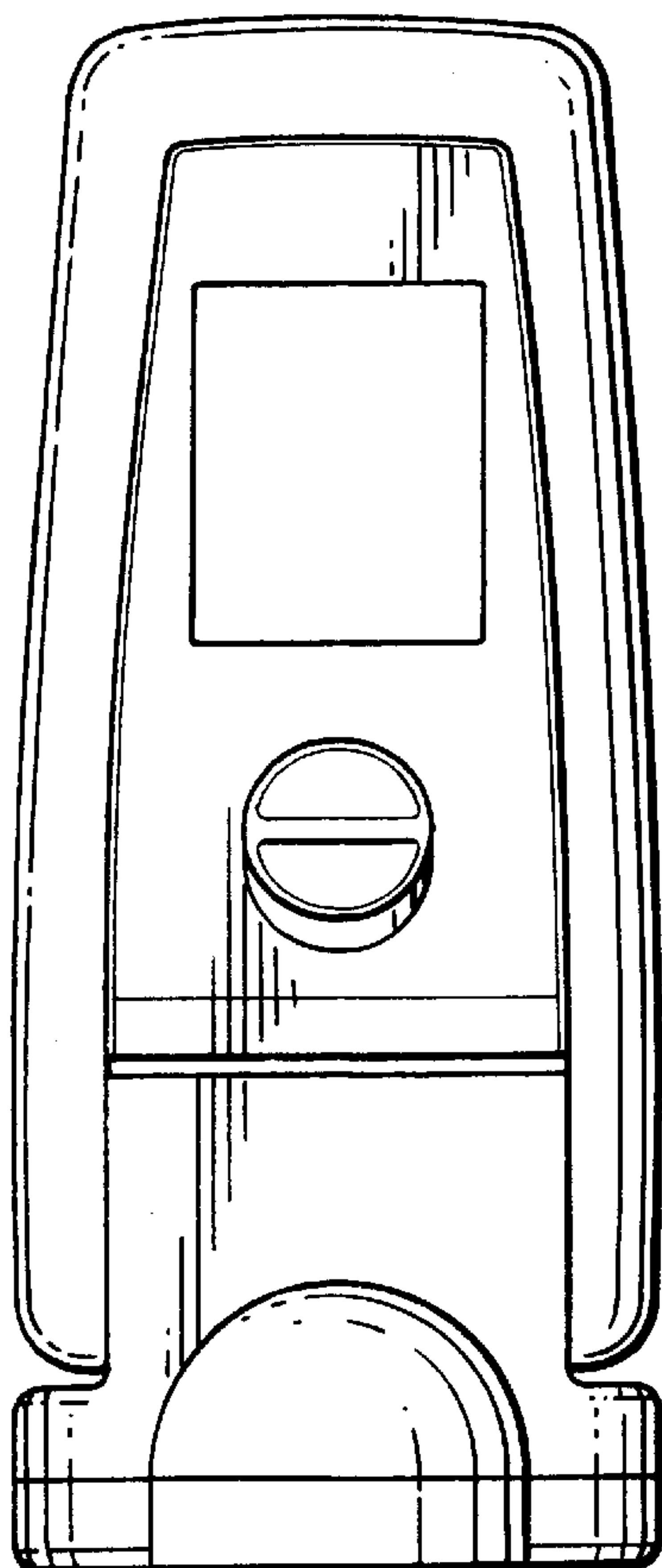

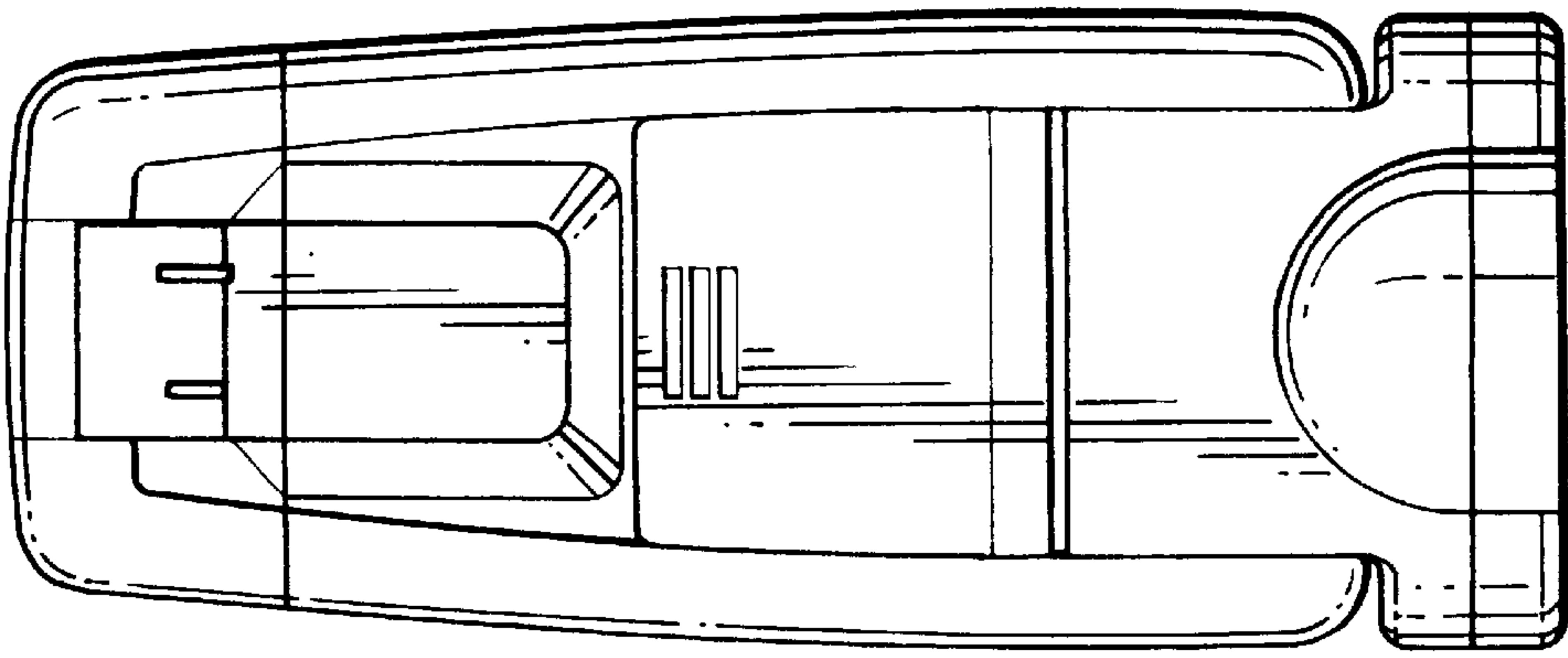

FIG.1

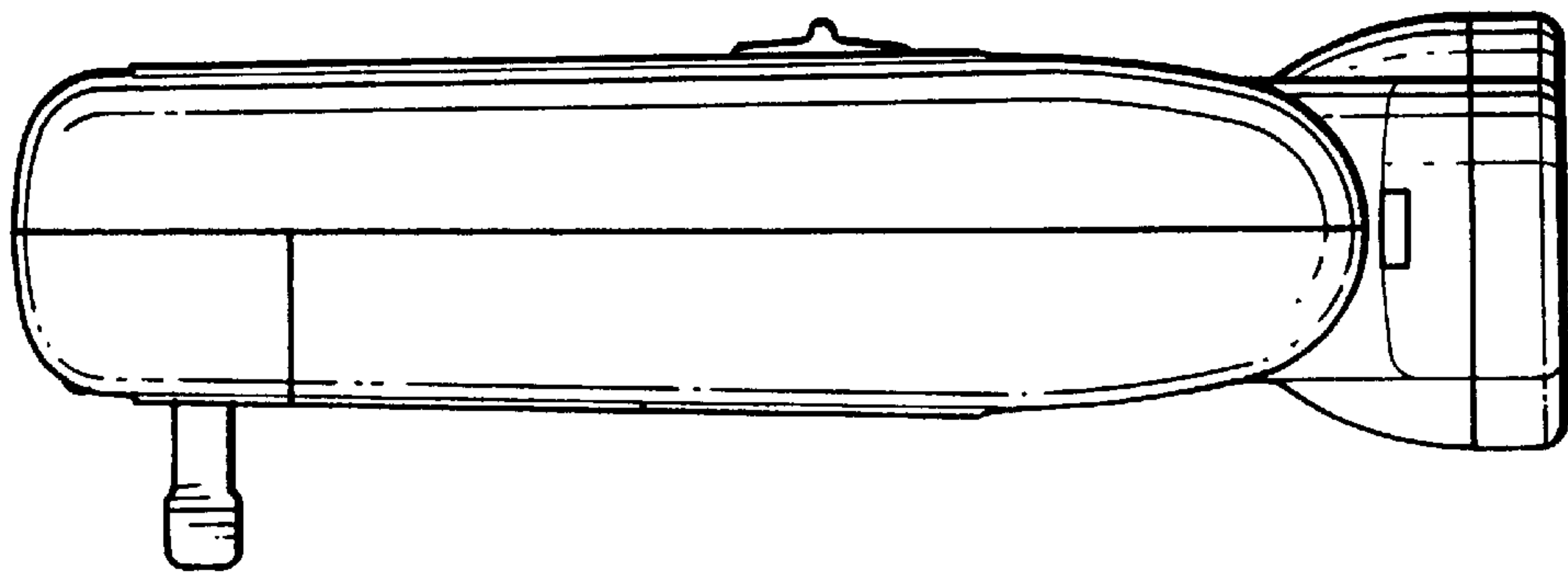

FIG.2

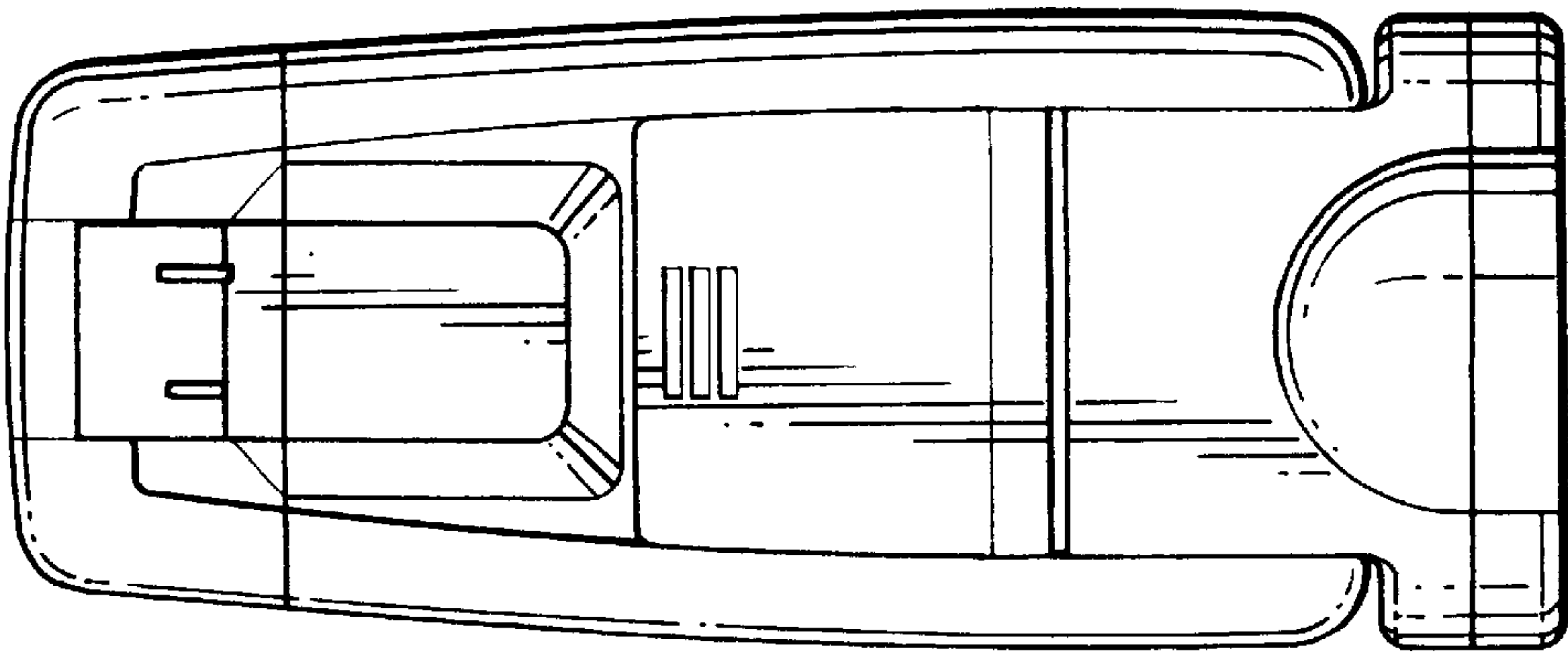

FIG.3

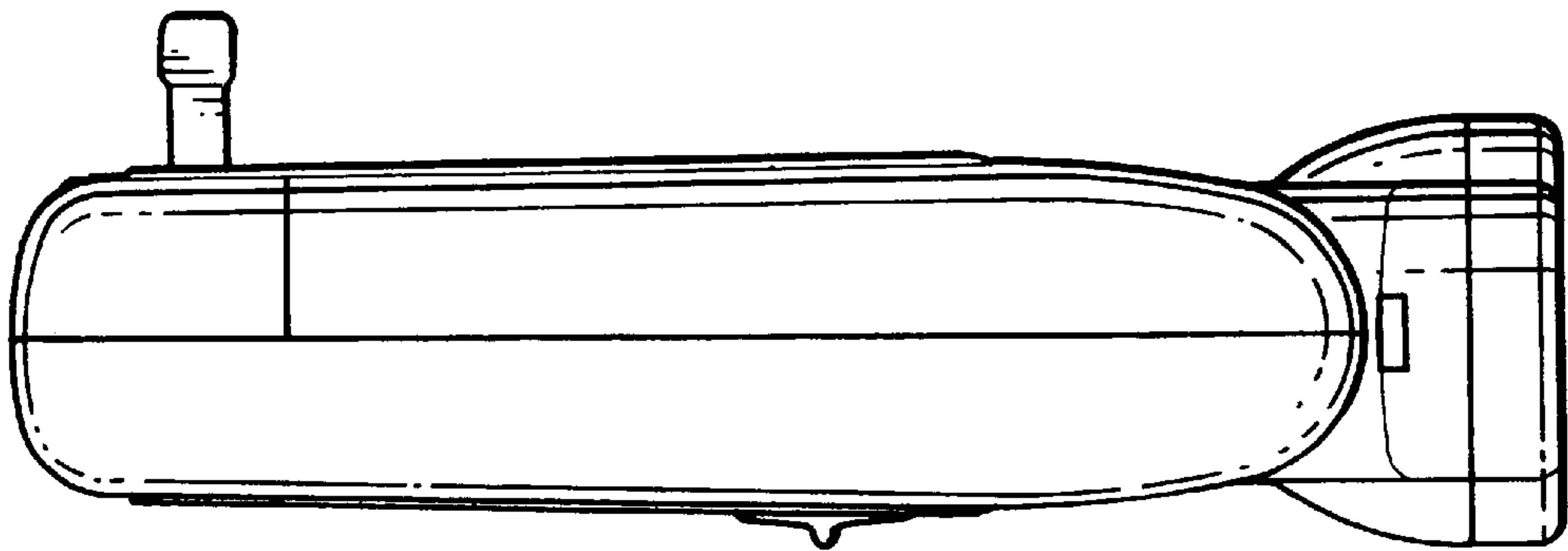

FIG. 4

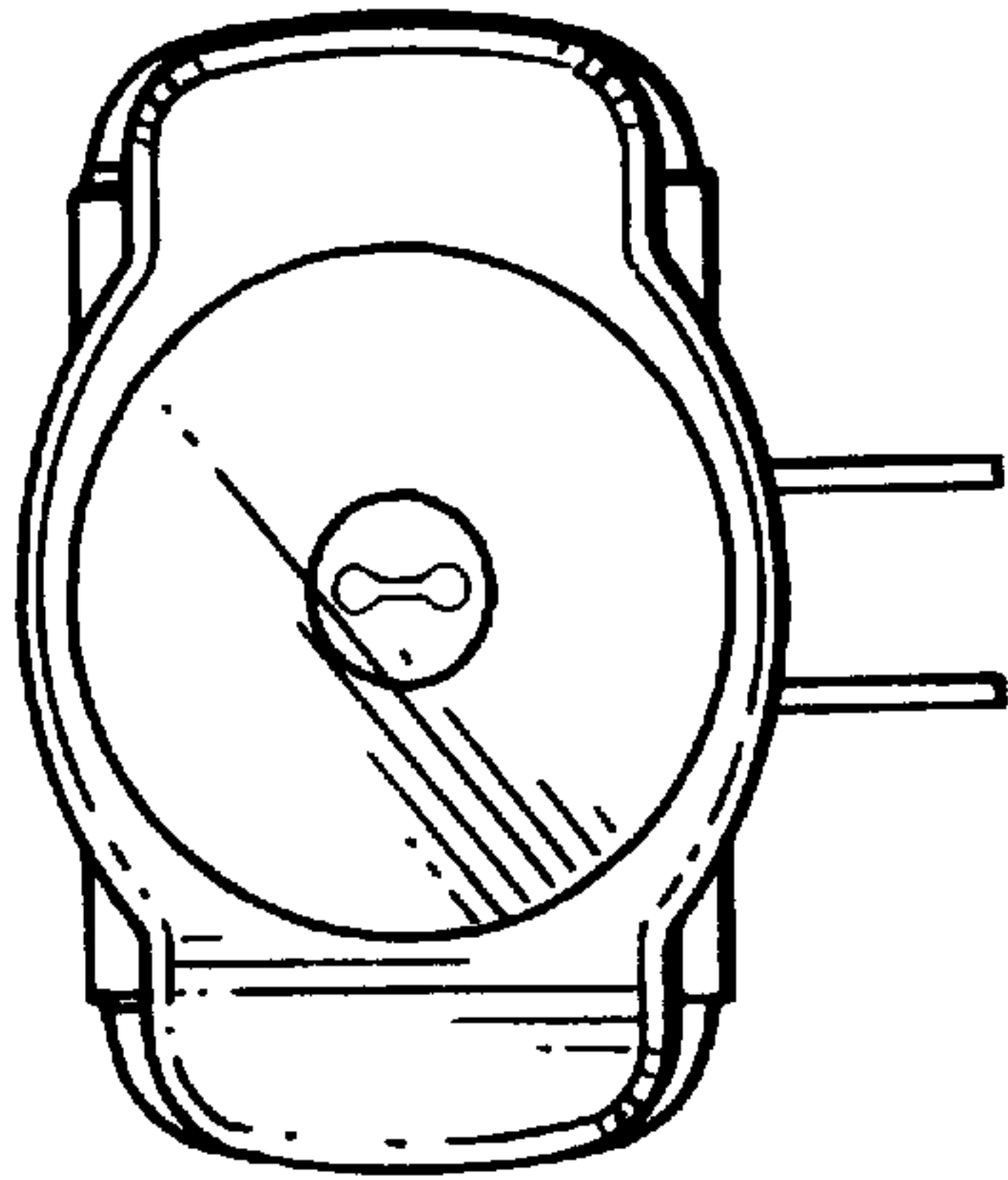

FIG. 5

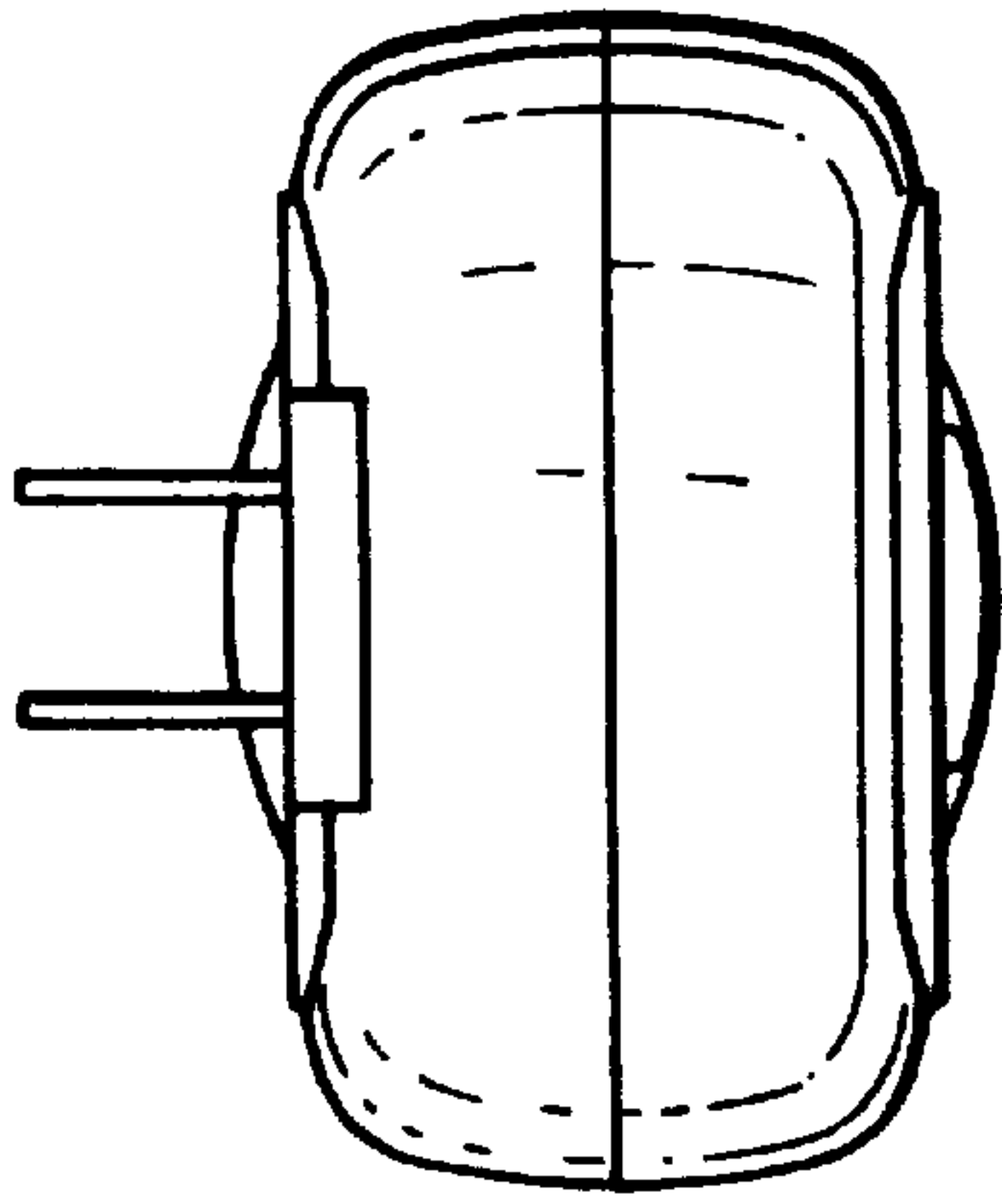

FIG. 6

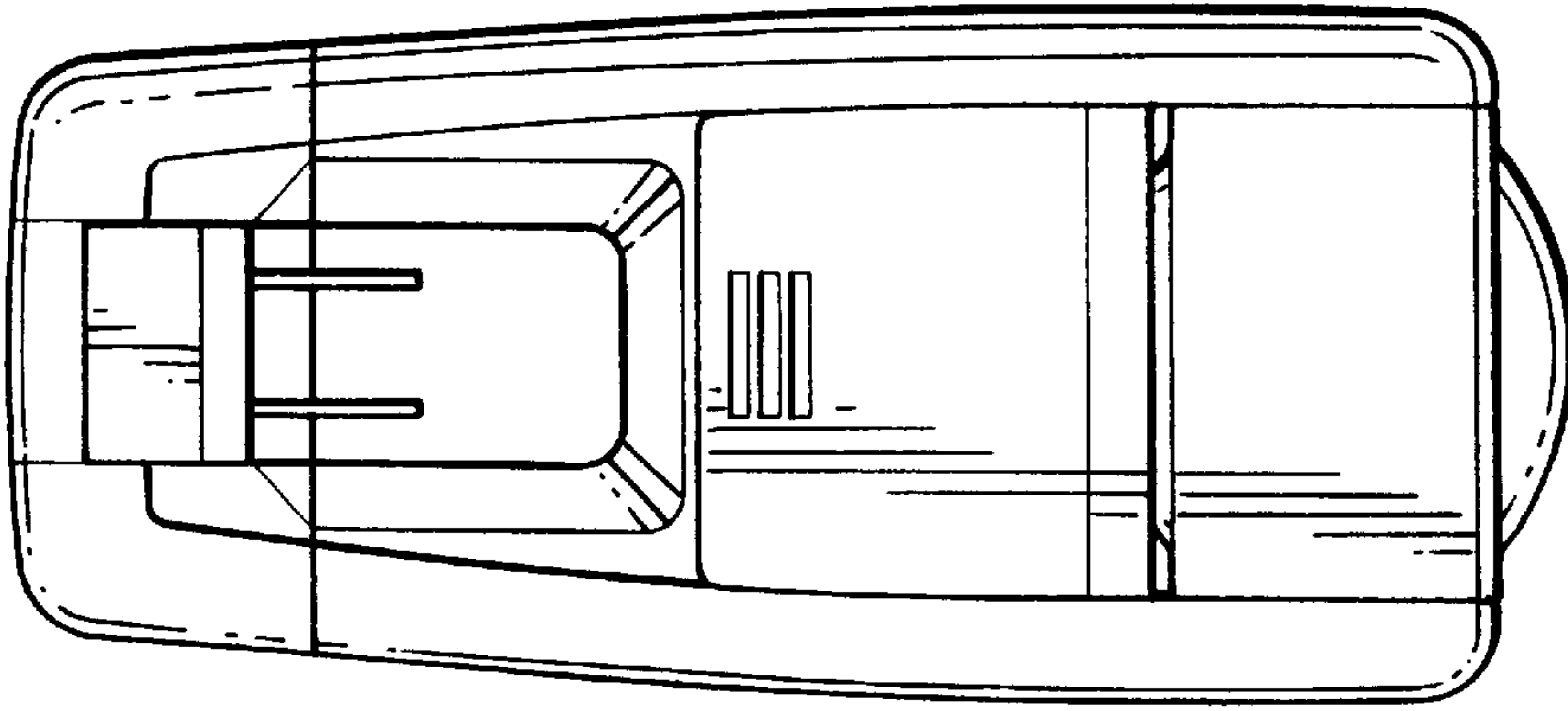

FIG. 9

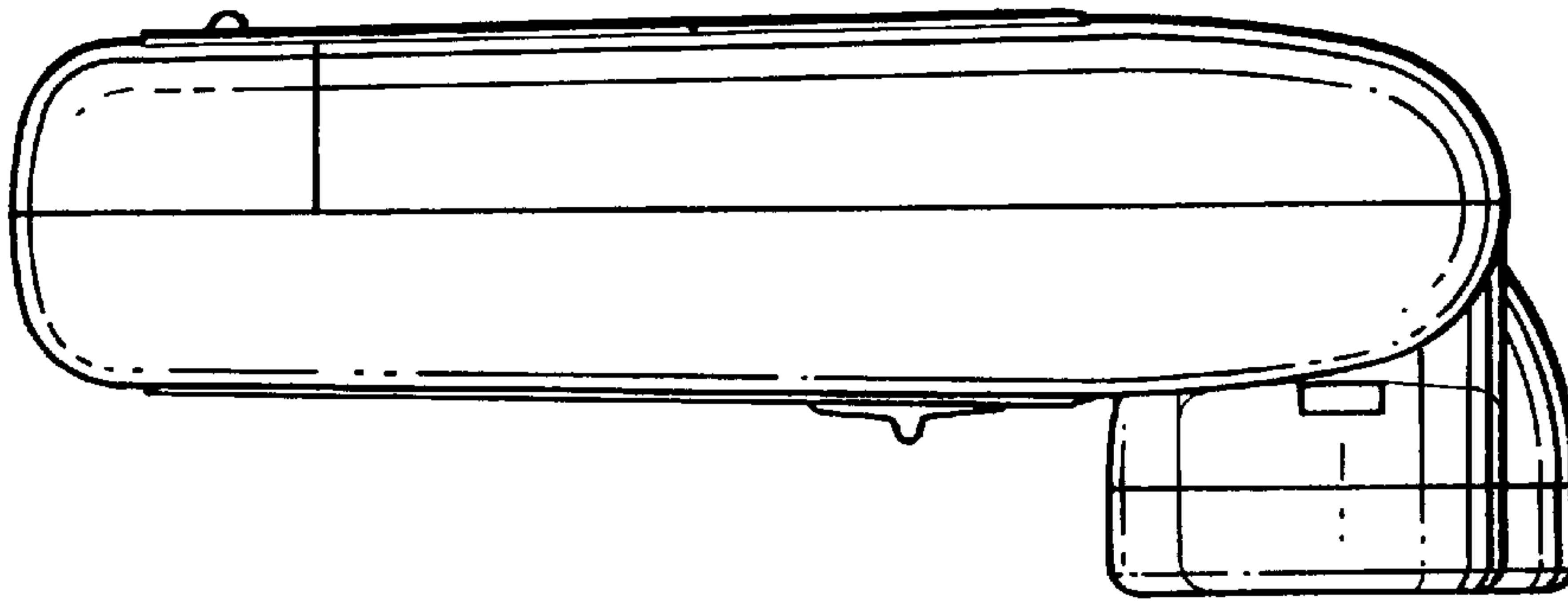

FIG. 8

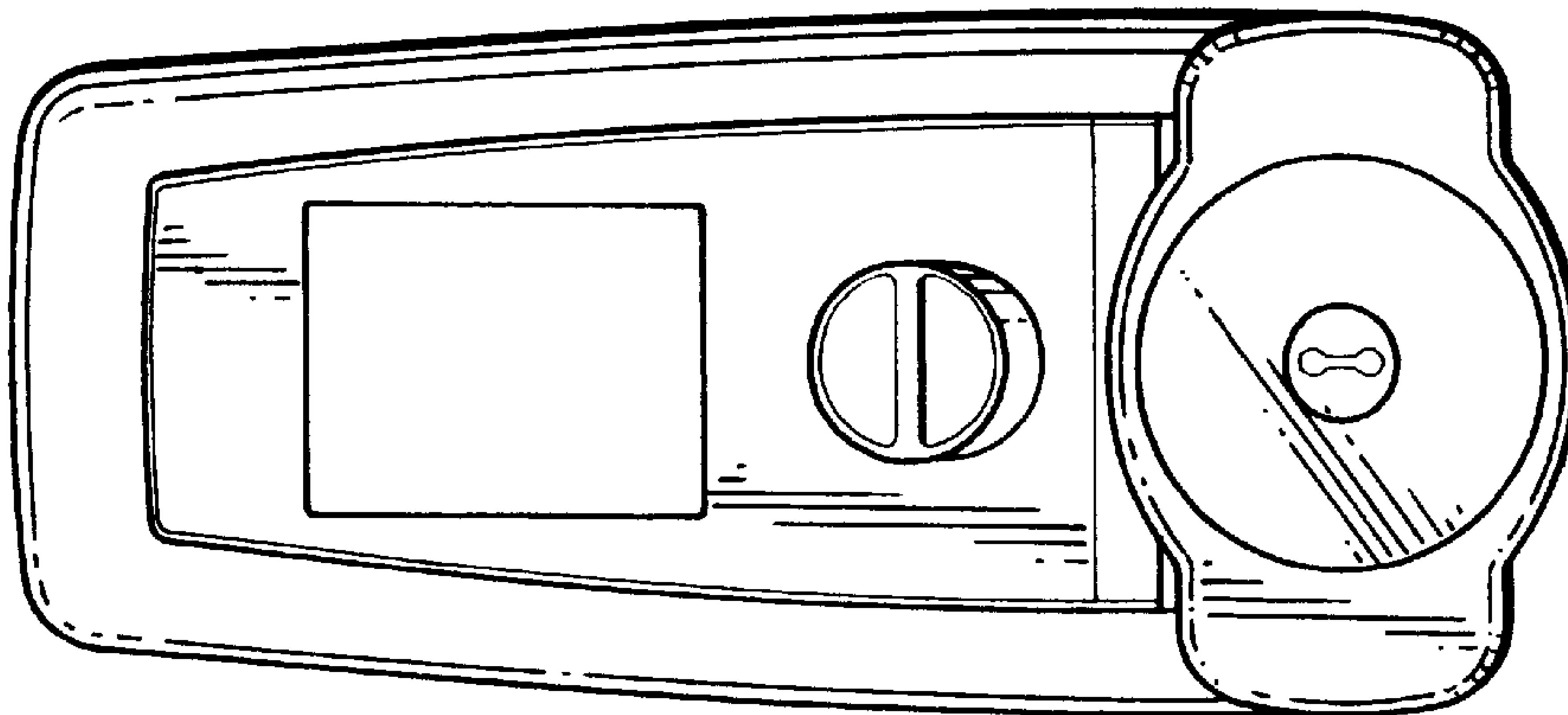

FIG. 7

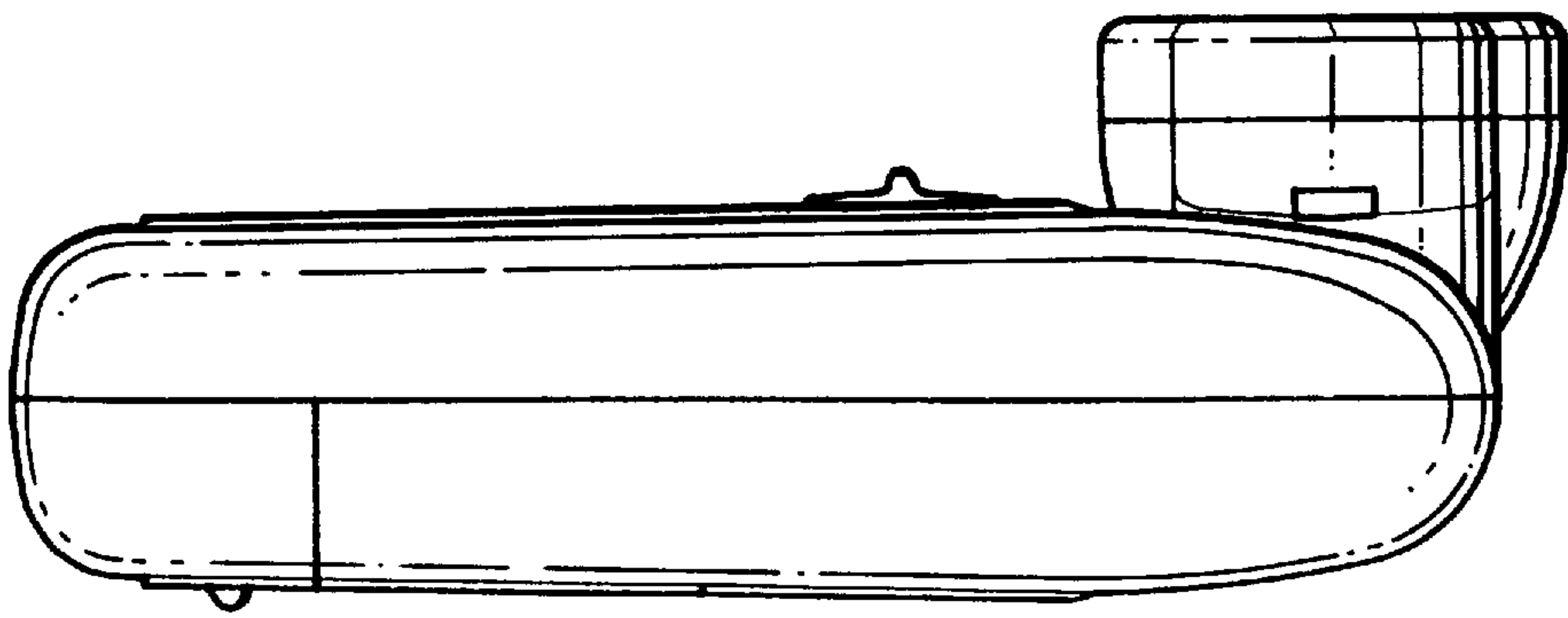

FIG. 10

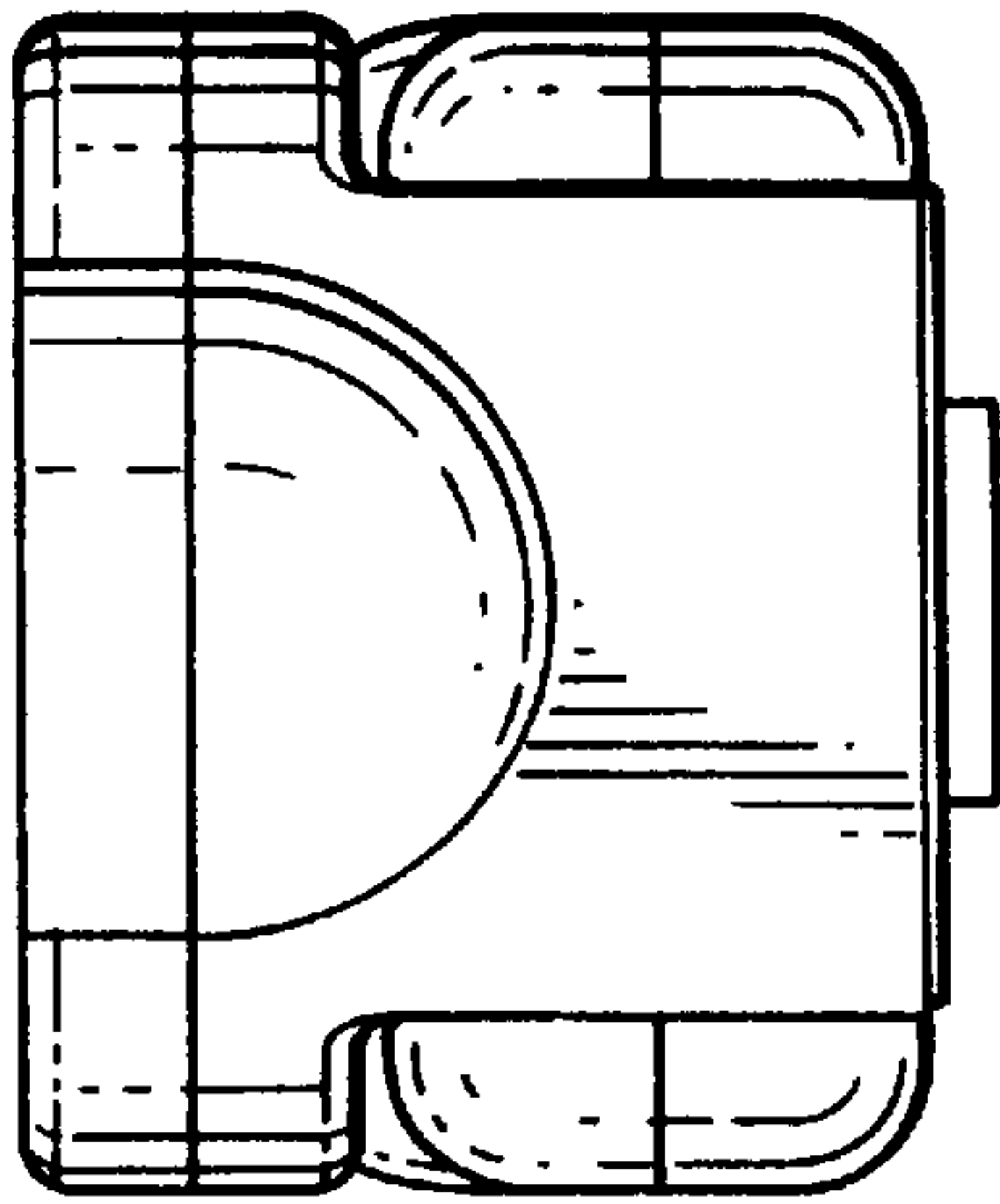

FIG. 11

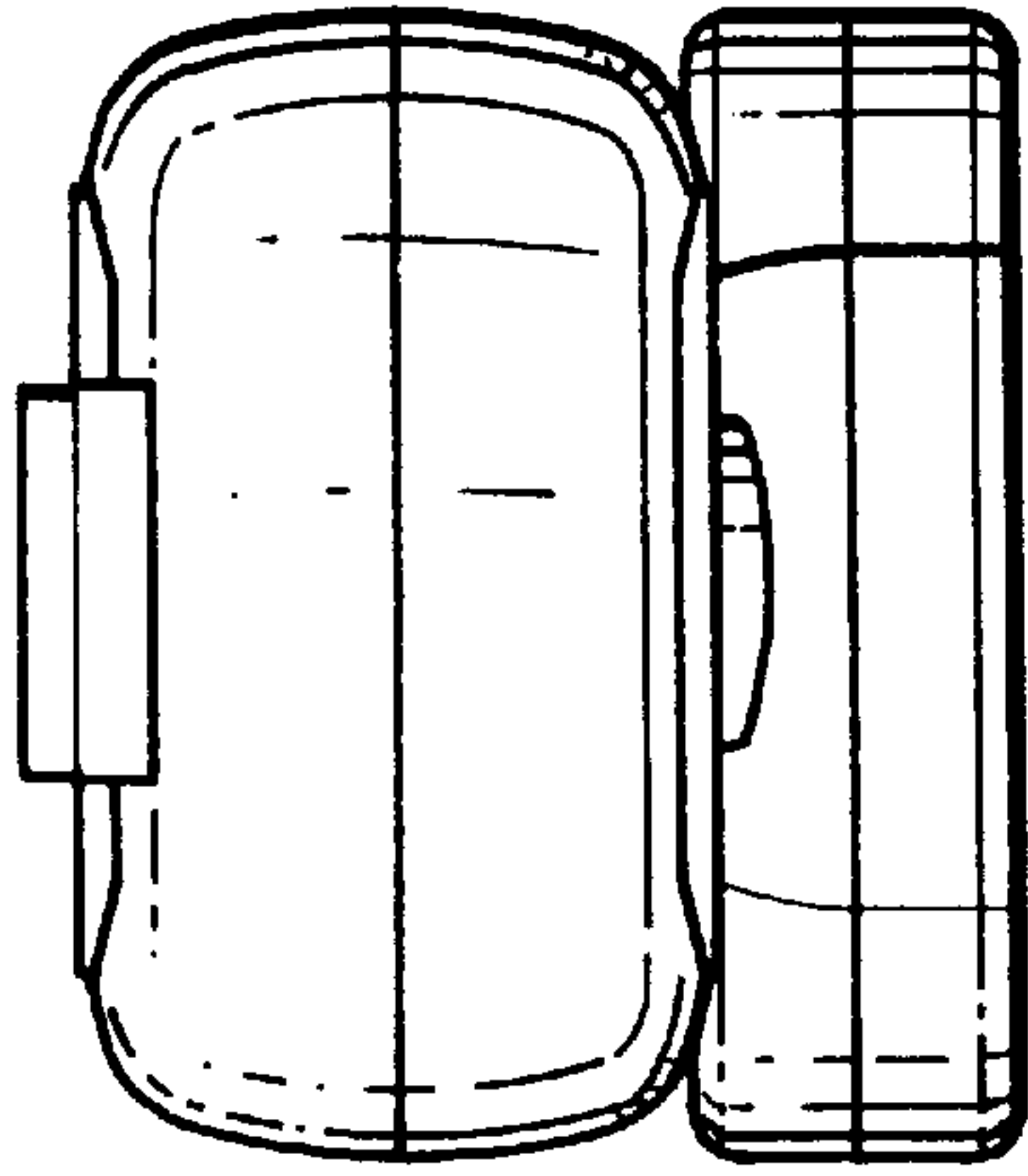

FIG. 12