



US00D406801S

United States Patent [19]

[11] **Patent Number: Des. 406,801**

Robb et al.

[45] **Date of Patent: **Mar. 16, 1999**

[54] **MOTORCYCLE BODY**

Primary Examiner—Melody N. Brown
Attorney, Agent, or Firm—Evenson, McKeown, Edwards & Lenahan, PLLC

[75] Inventors: **David Robb**, München; **Karl Heinz Abe**, Kaufering, both of Germany; **John W. Krieger**, Oxnard, Calif.

[57] **CLAIM**

[73] Assignee: **Bayerische Motoren Werke Aktiengesellschaft**, Munich, Germany

The ornamental design for a motorcycle body, as shown and described.

[**] Term: **14 Years**

DESCRIPTION

[21] Appl. No.: **84,149**

FIG. 1 is a front view of a motorcycle body according to our novel design;

[22] Filed: **Feb. 25, 1998**

FIG. 2 is a left side view of a motorcycle body according to our novel design;

[30] **Foreign Application Priority Data**

FIG. 3 is a right side view of a motorcycle body according to our novel design;

Aug. 25, 1997 [DE] Germany M 97 08 136.1

FIG. 4 is a rear view of a motorcycle body according to our novel design;

[51] **LOC (6) Cl.** **12-11**

FIG. 5 is a top view of a motorcycle body according to our novel design;

[52] **U.S. Cl.** **D12/110**

FIG. 6 is a perspective view from the front right side of a motorcycle body according to our novel design; and,

[58] **Field of Search** D12/110; 180/219

FIG. 7 is a perspective view from the rear left side of a motorcycle body according to our novel design.

[56] **References Cited**

U.S. PATENT DOCUMENTS

D. 380,989	7/1997	Abe et al.	D12/110
D. 382,835	8/1997	Abe et al.	D12/110
D. 383,096	9/1997	Abe et al.	D12/110

1 Claim, 6 Drawing Sheets

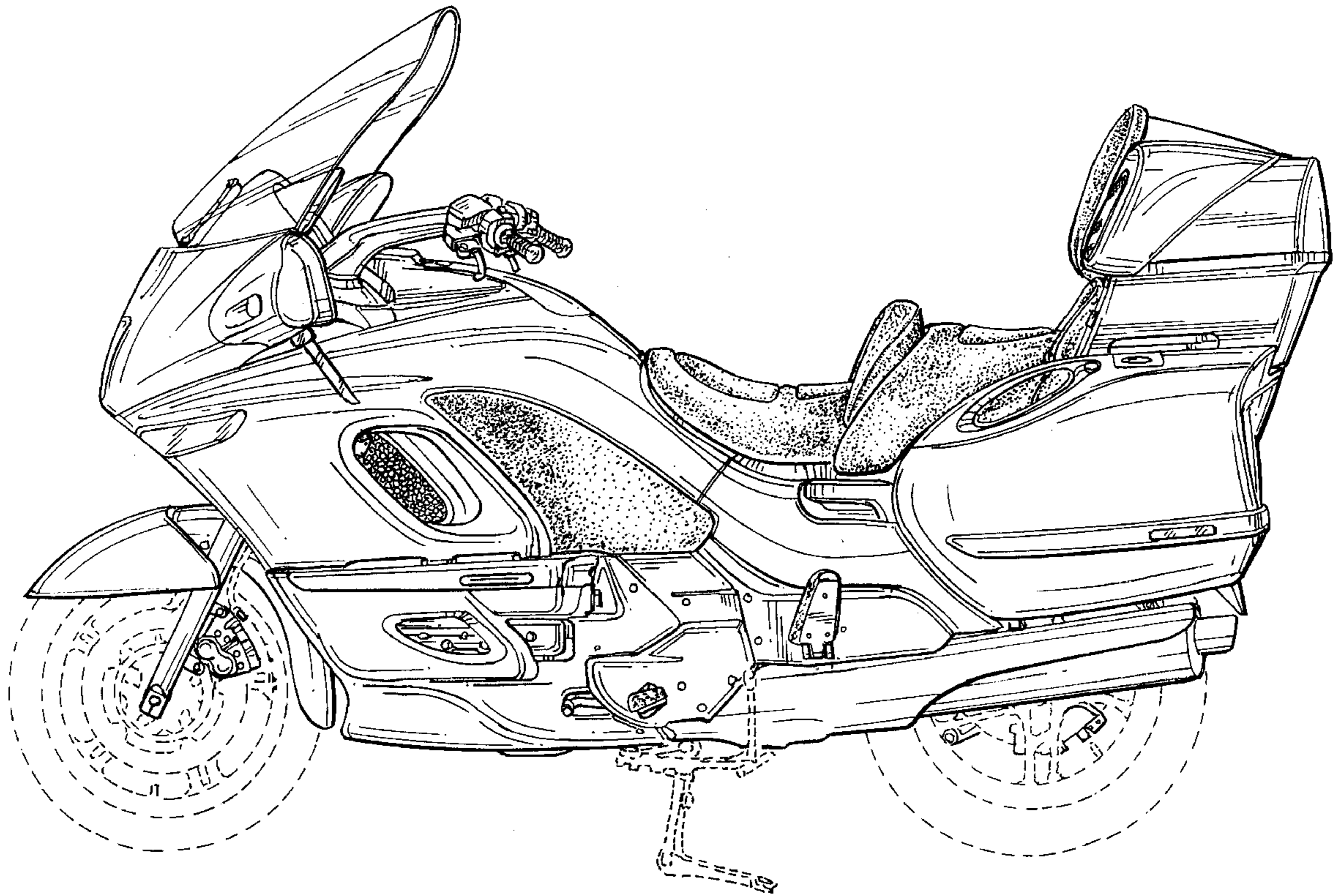

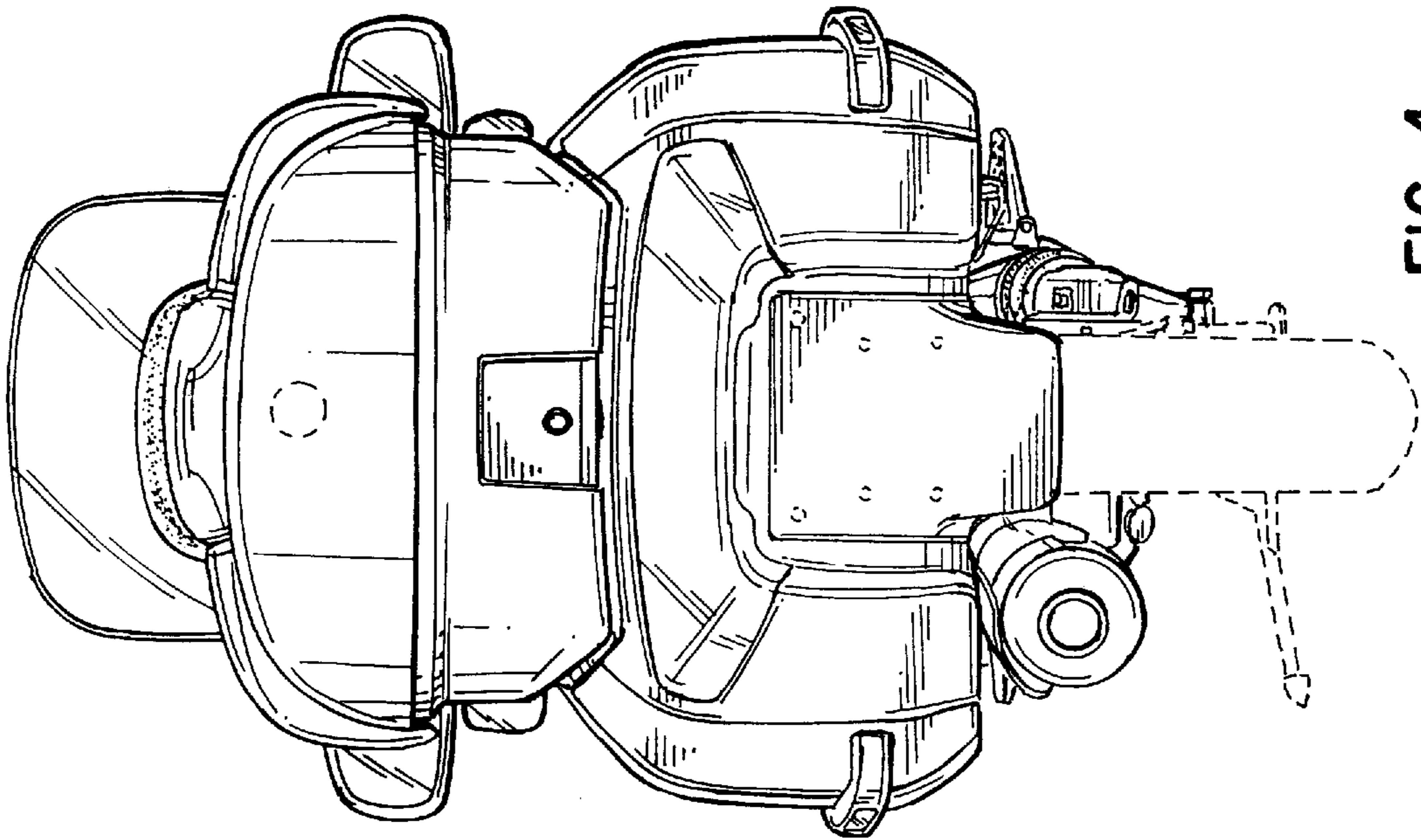

FIG. 4

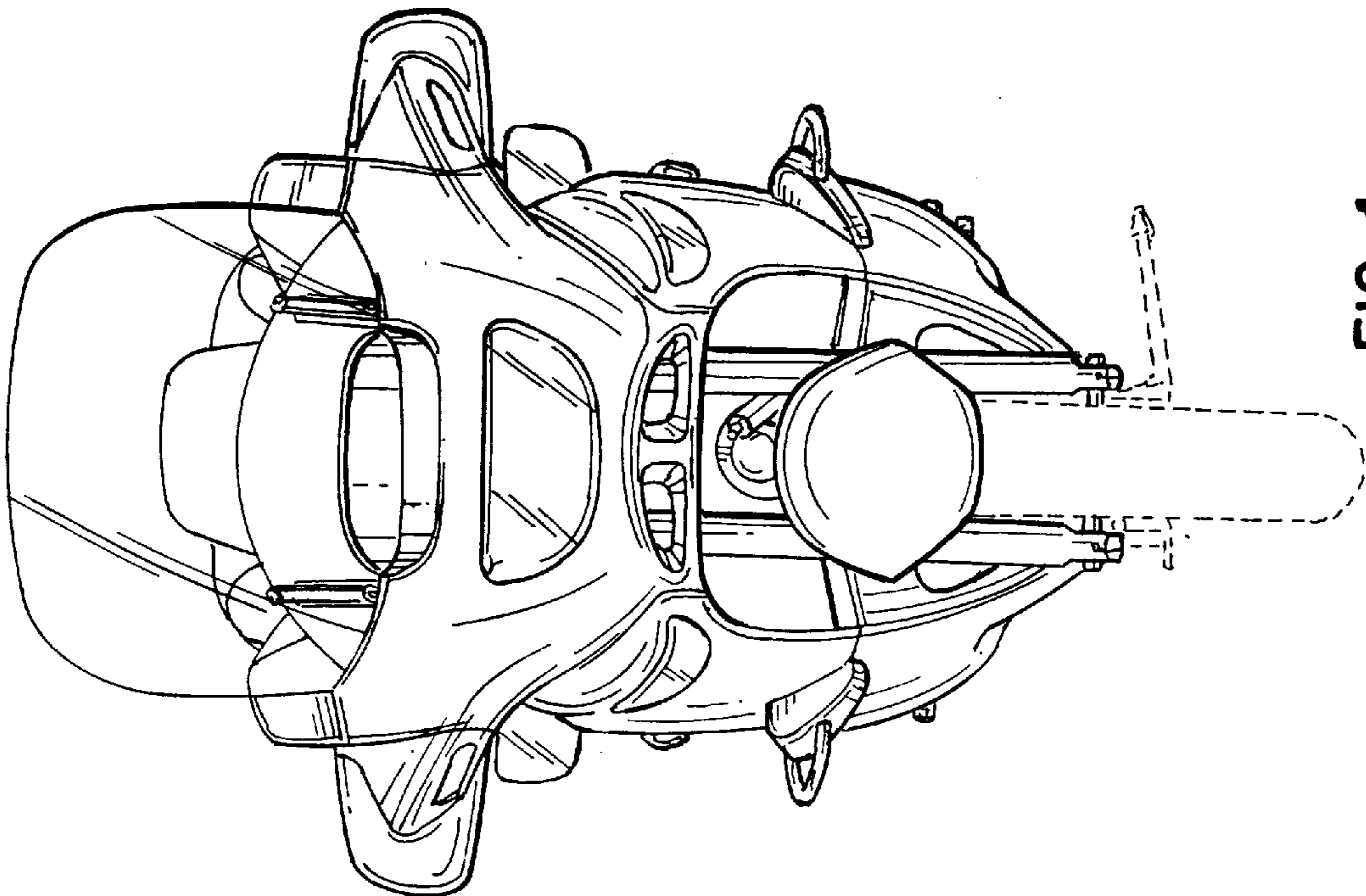

FIG. 1

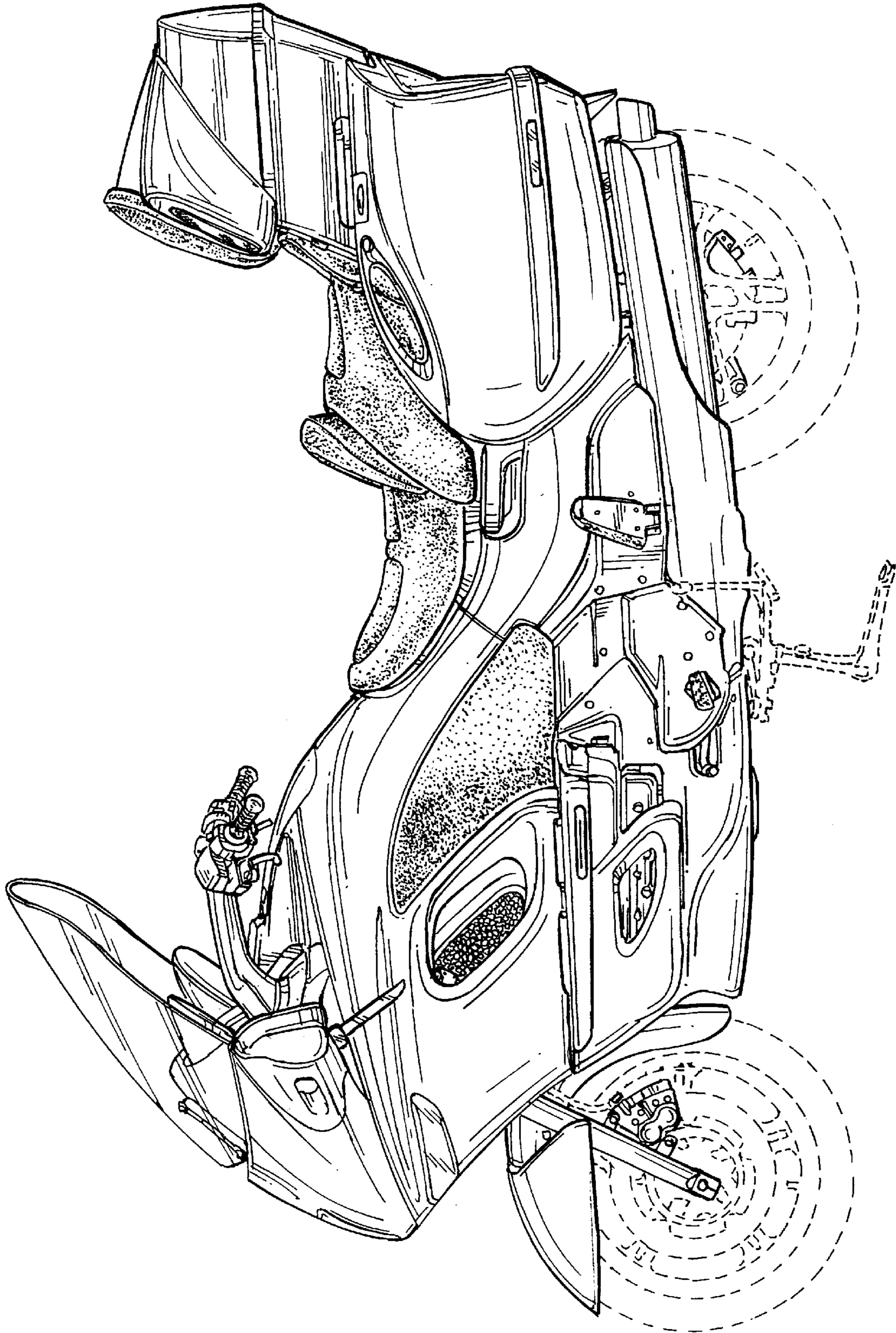

FIG. 2

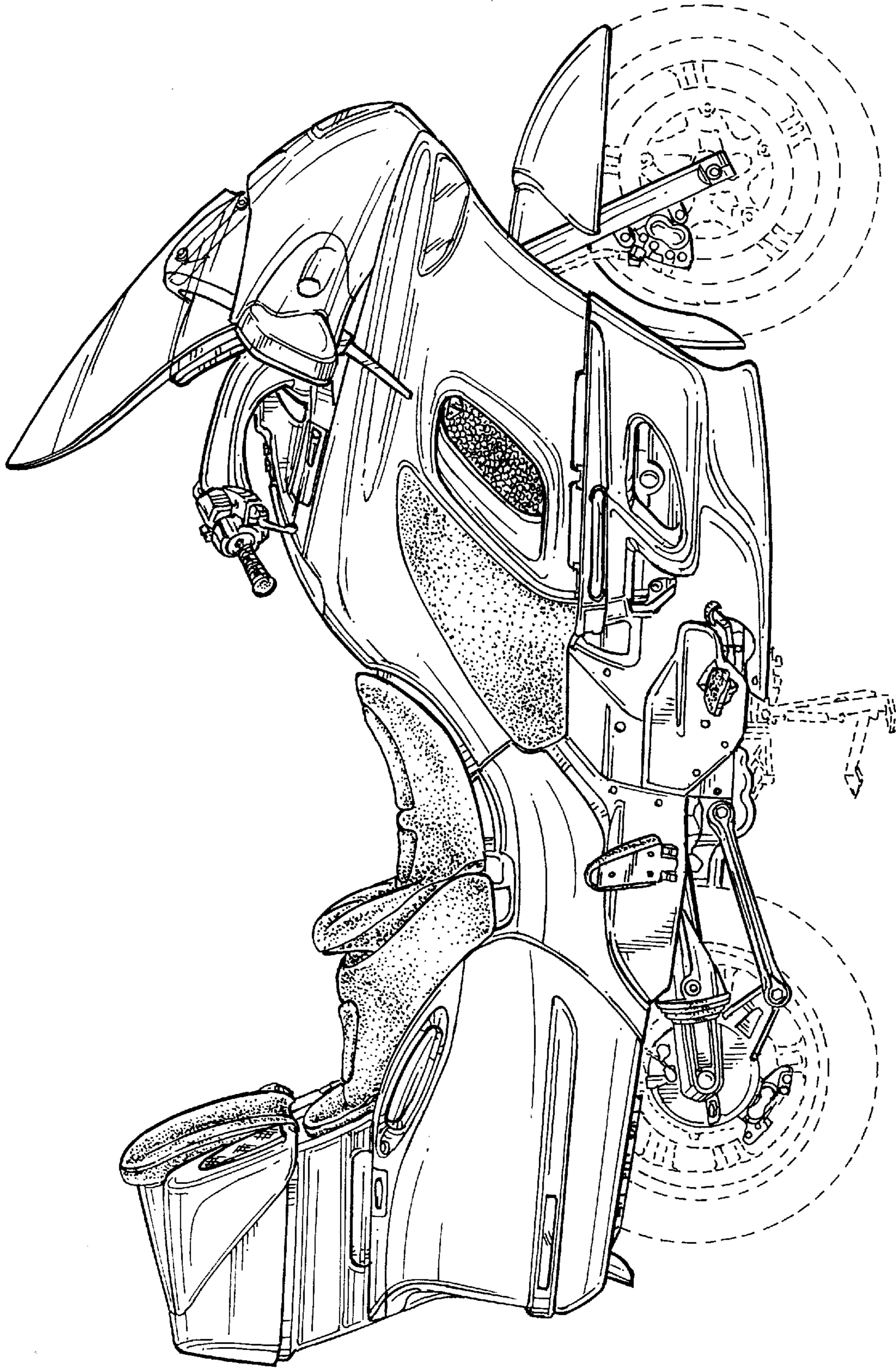

FIG. 3

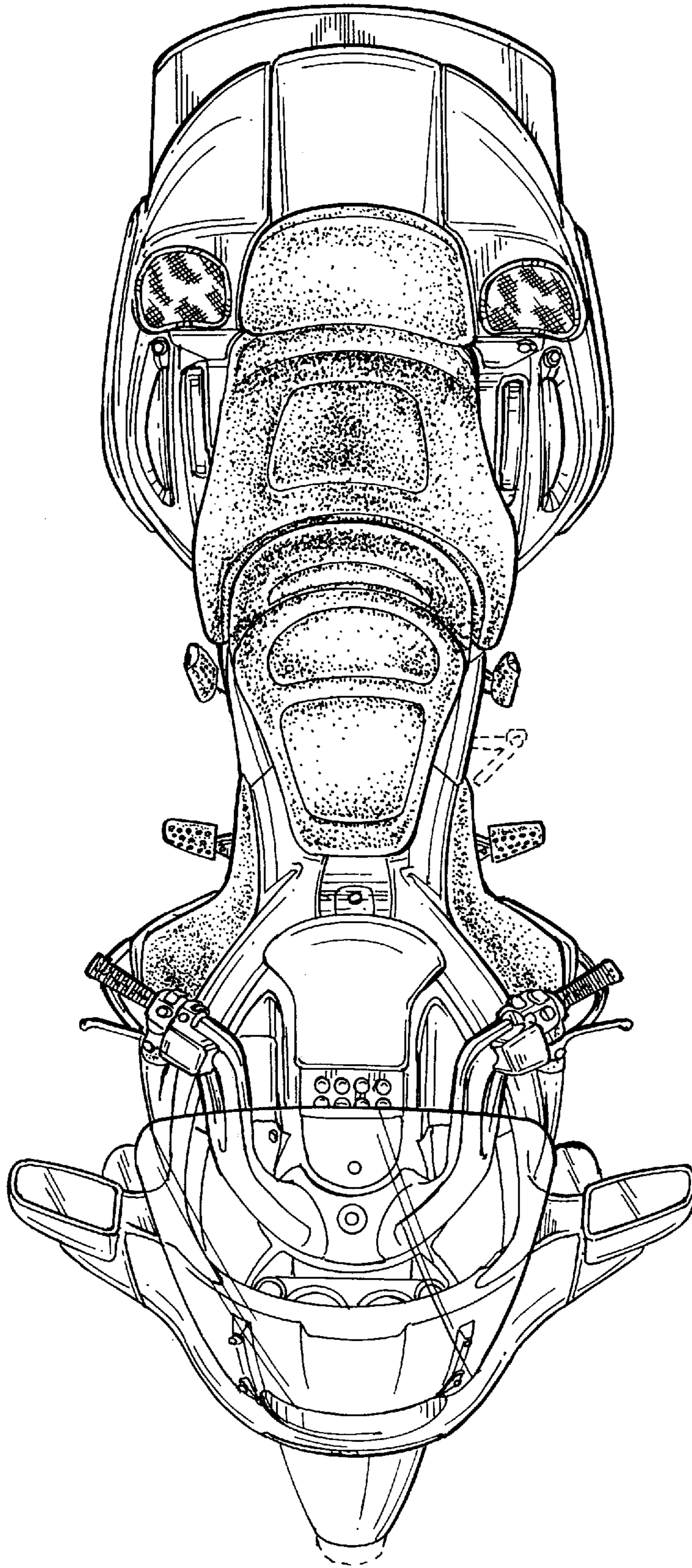

FIG. 5

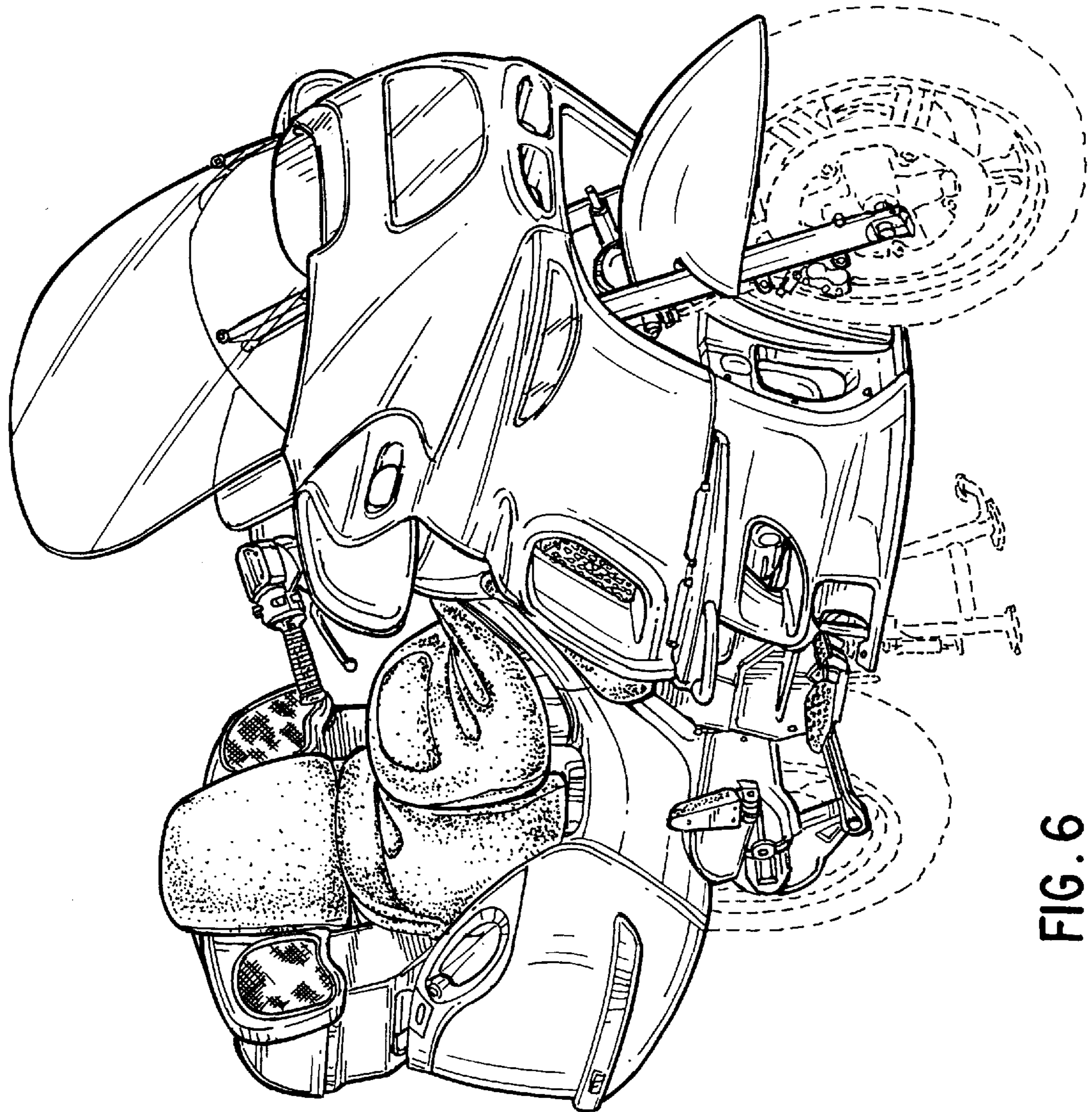

FIG. 6

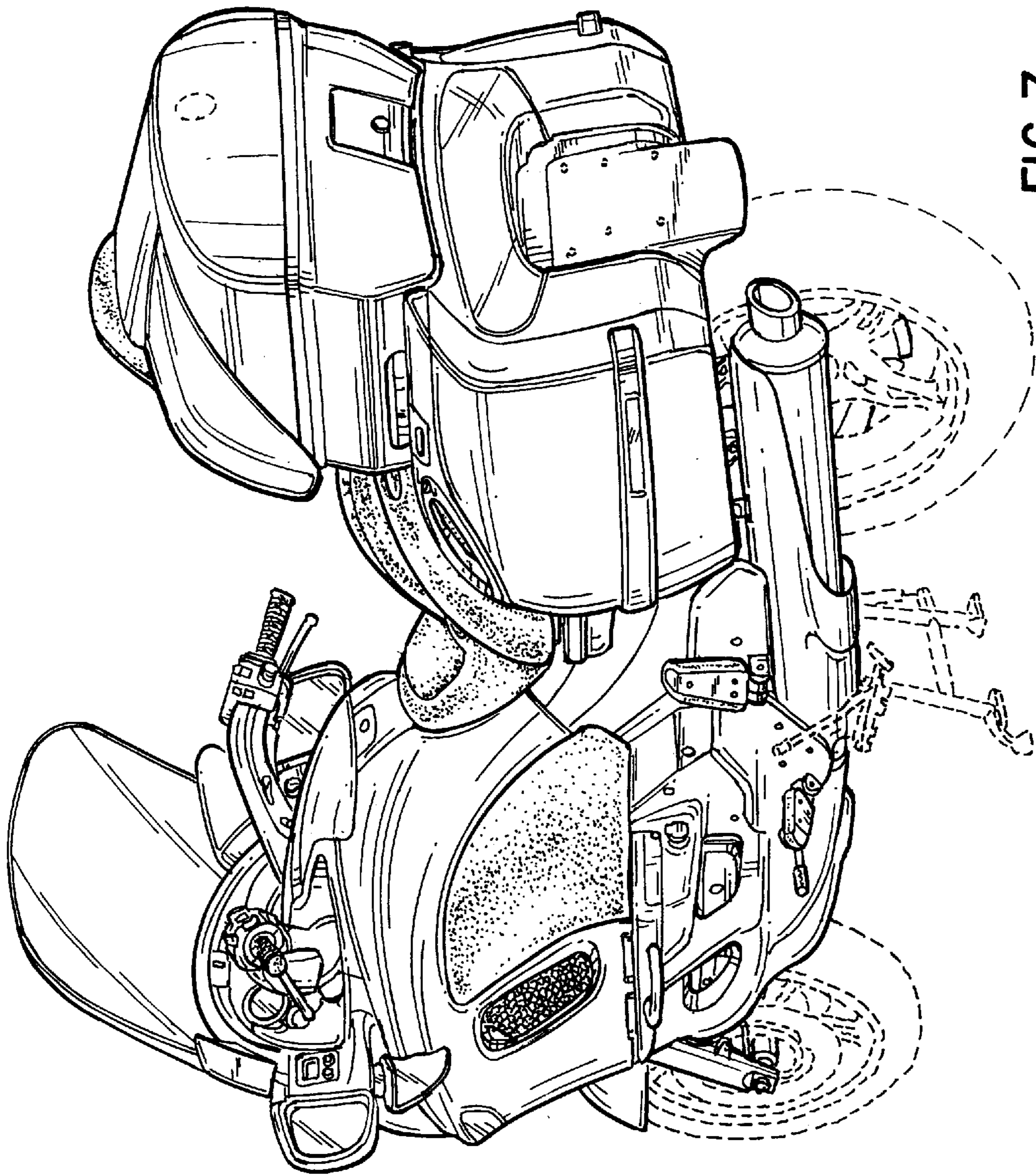

FIG. 7