



US00D406753S

United States Patent [19]
Lee

[11] **Patent Number: Des. 406,753**

[45] **Date of Patent: **Mar. 16, 1999**

[54] **PACKAGE**

[75] Inventor: **Noel Lee**, South San Francisco, Calif.

[73] Assignee: **Monster Cable International, Ltd.**,
So. San Francisco, Calif.

[**] Term: **14 Years**

[21] Appl. No.: **49,607**

[22] Filed: **Dec. 29, 1995**

[51] **LOC (6) Cl.** **09-07**

[52] **U.S. Cl.** **D9/415**

[58] **Field of Search** D9/415, 418, 414,
D9/337, 341, 346; 206/461-471, 806, 495,
769-773

[56] **References Cited**

U.S. PATENT DOCUMENTS

D. 289,737	5/1987	Lindsey et al.	D9/415
D. 328,249	7/1992	Lee	D9/415
D. 332,398	1/1993	Lee et al.	D9/415
D. 344,019	2/1994	Pratt	D9/415
D. 365,022	12/1995	Wada	D9/415
2,876,899	3/1959	Maynard, Jr.	206/471
3,754,643	8/1973	Foster	206/471 X
4,249,658	2/1981	Ogura	206/461 X
4,669,610	6/1987	Lindsey et al.	206/471 X

OTHER PUBLICATIONS

Modern Packaging, 1940, p. 300.
Packaging, Jun. 1986, p. 13.

Primary Examiner—Prabhakar G. Deshmukh
Attorney, Agent, or Firm—Ostrolenk, Faber, Gerb & Soffen,
LLP

[57] **CLAIM**

The ornamental design for a package, as shown and described.

DESCRIPTION

FIG. 1 is a top, front and right side perspective view of a package showing my new design;
FIG. 2 is a front elevational view thereof;
FIG. 3 is a right side view thereof;
FIG. 4 is a left side view thereof;
FIG. 5 is a top plan view thereof;
FIG. 6 is a bottom plan view thereof;
FIG. 7 is a rear elevational view thereof;
FIG. 8 is a cross-sectional view taken along lines 8—8 of FIG. 2;
FIG. 9 is a cross-sectional view taken along lines 9—9 of FIG. 2; and,
FIG. 10 is a cross-sectional view taken along lines 10—10 of FIG. 2;

1 Claim, 7 Drawing Sheets

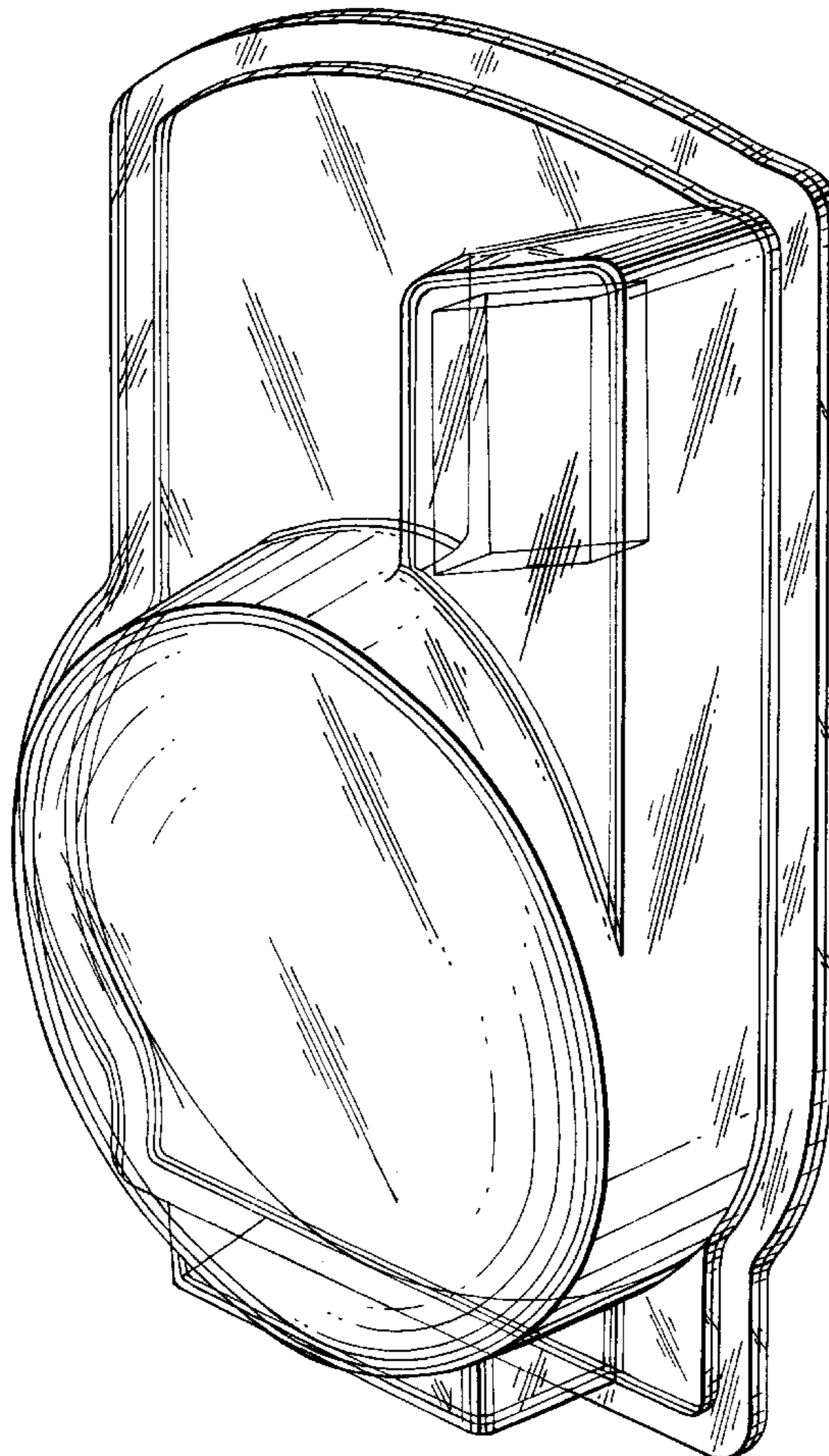

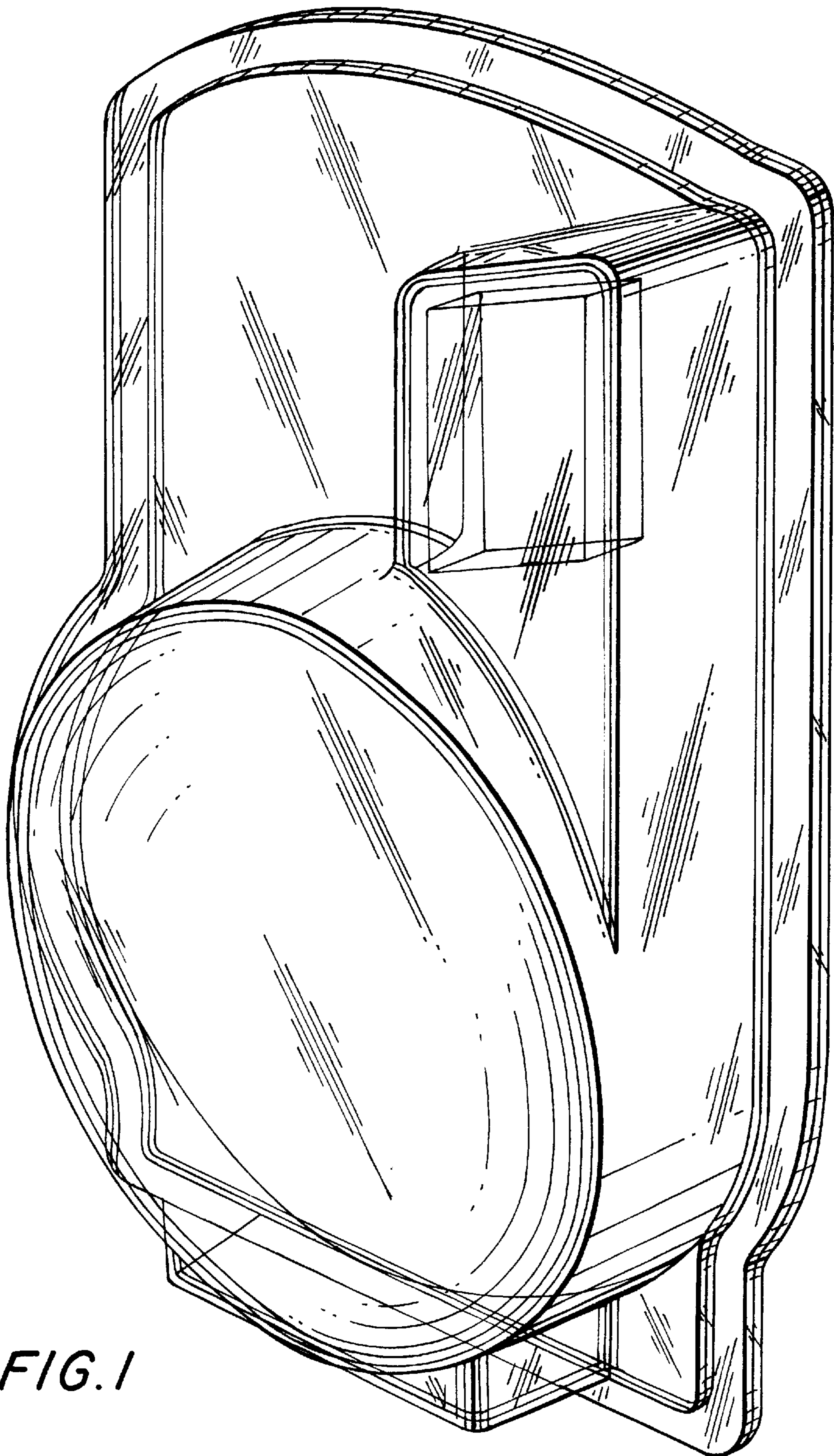
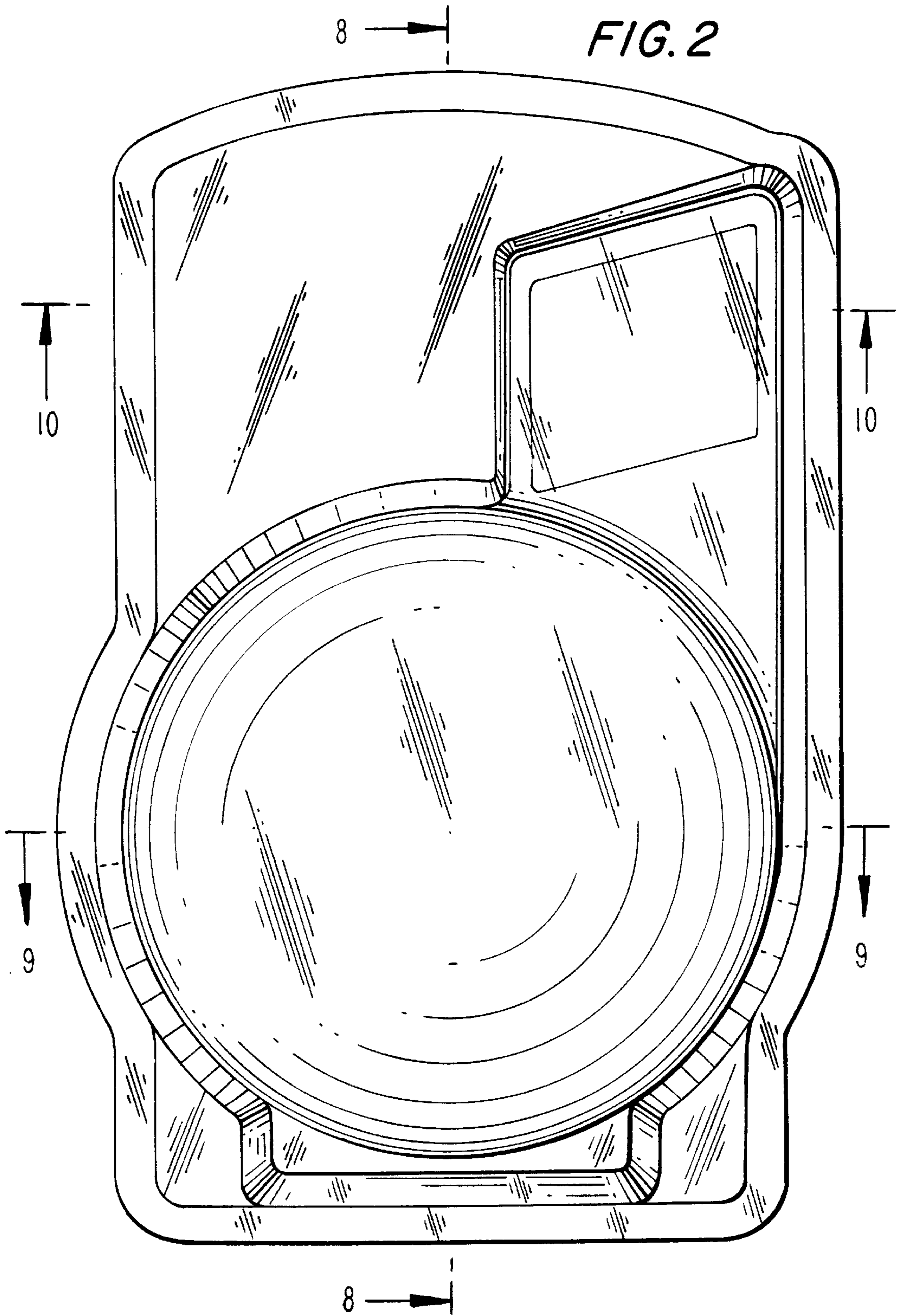

FIG. 1



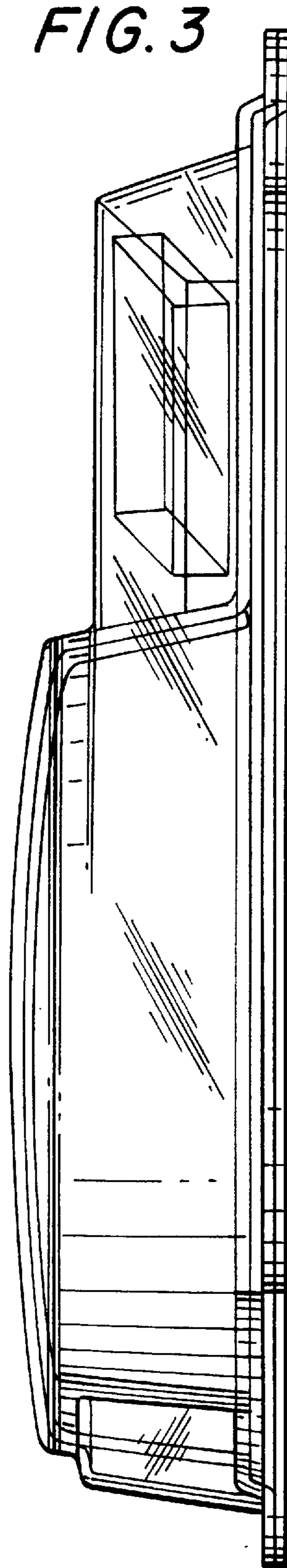
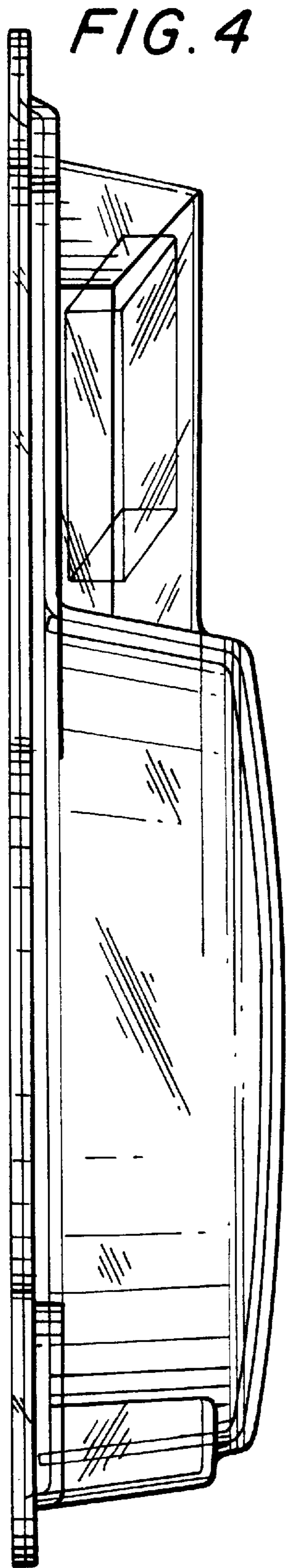

FIG. 5

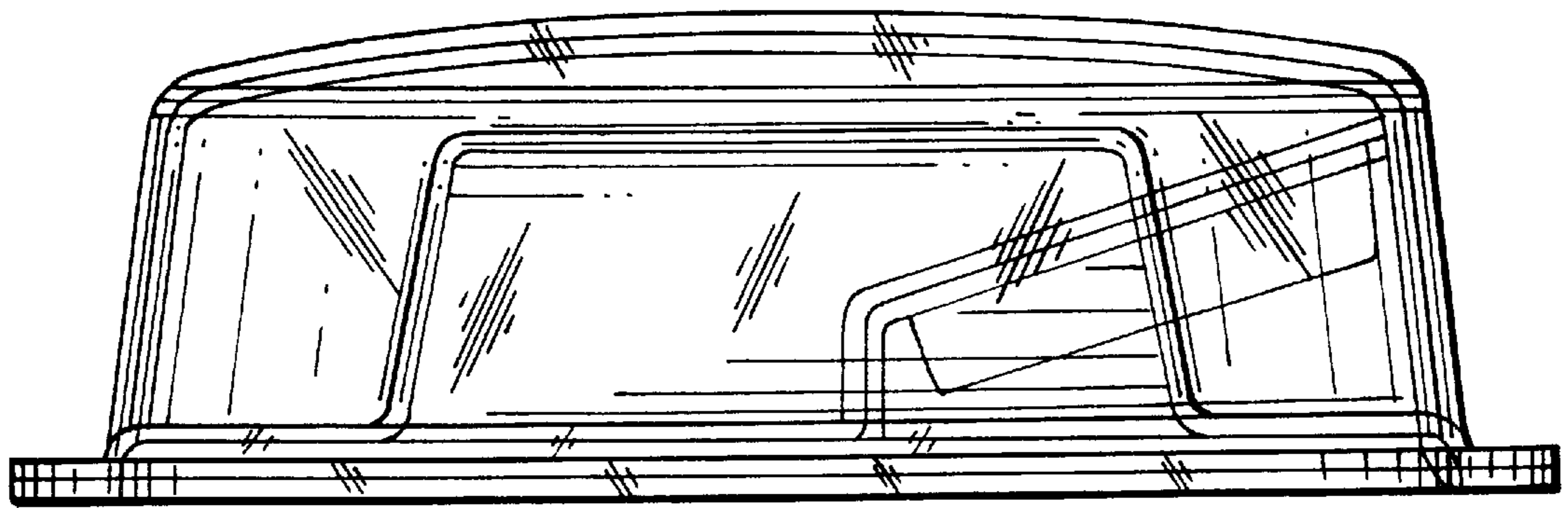
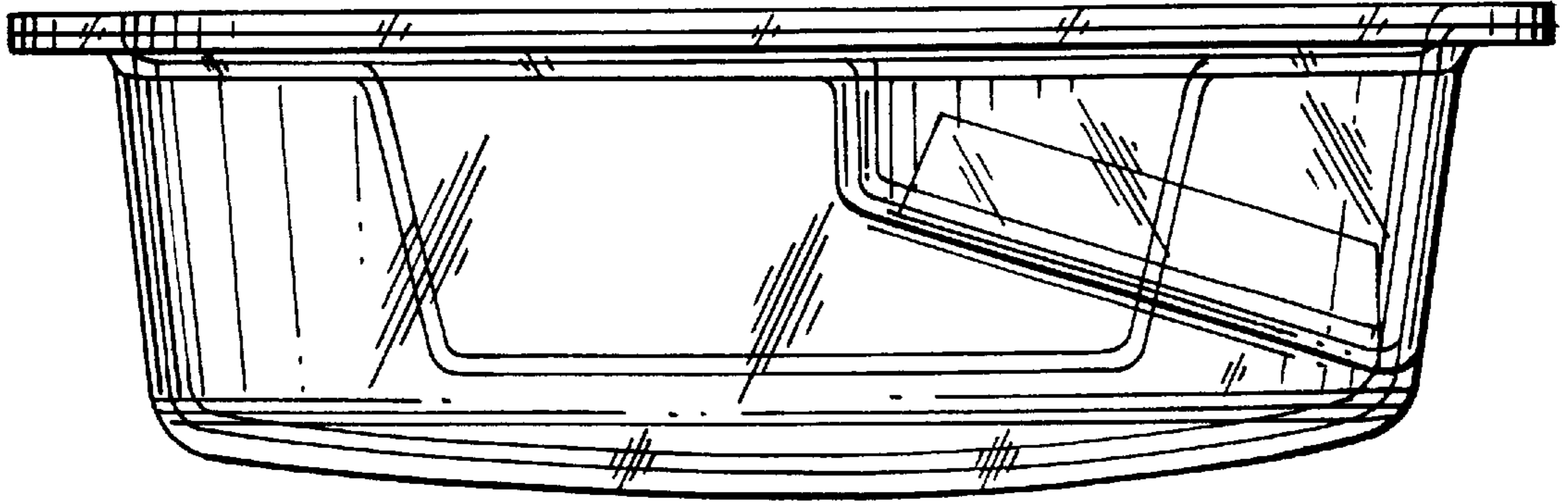
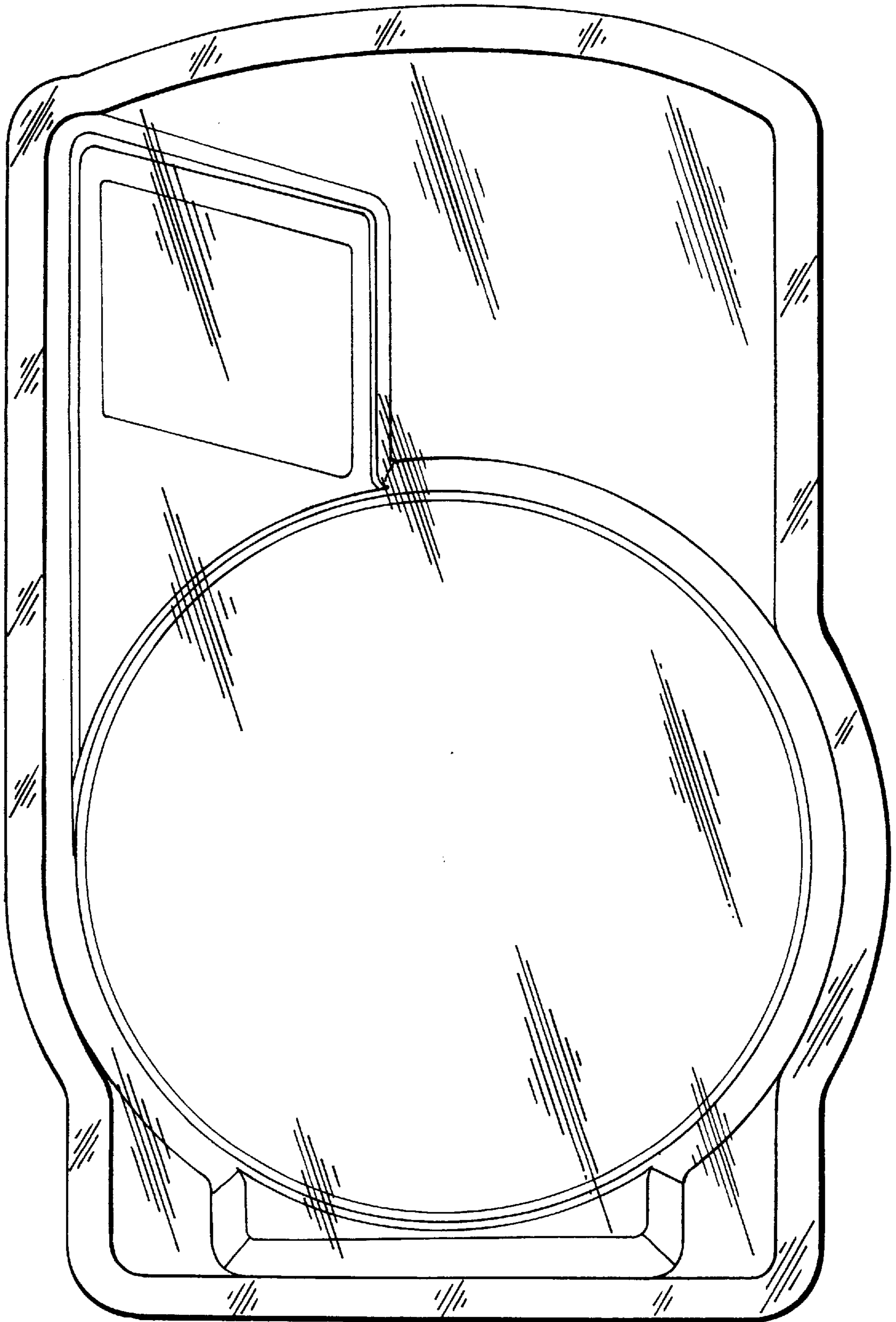

FIG. 6

FIG. 7



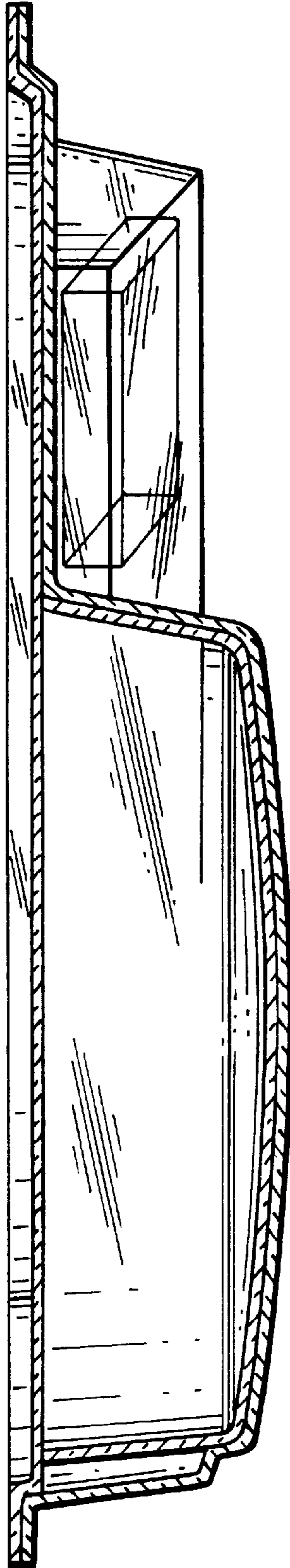

FIG. 8

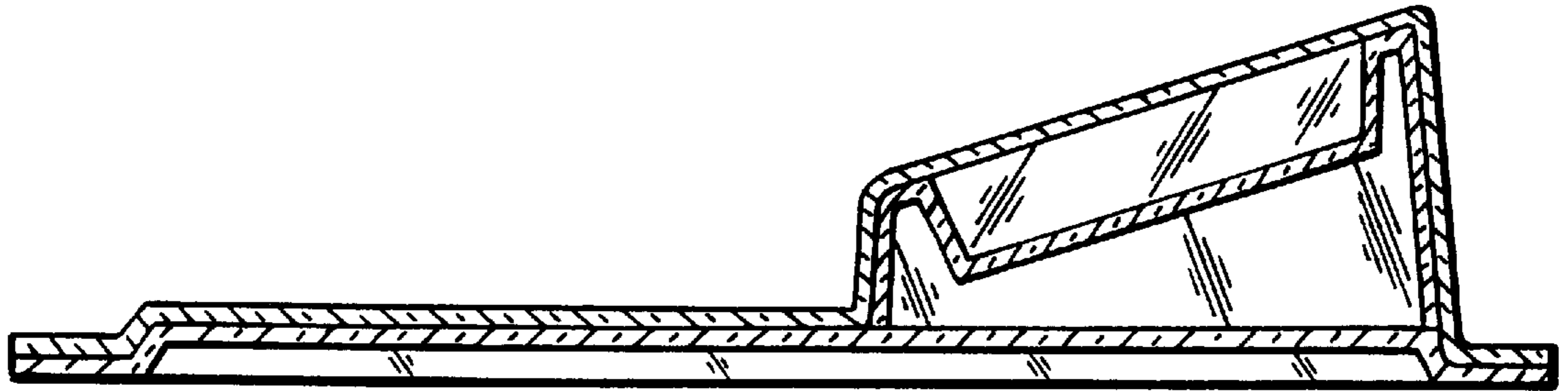

FIG. 10

FIG. 9

