



US00D406683S

United States Patent [19]

Taylor et al.

[11] Patent Number: **Des. 406,683**

[45] Date of Patent: ****Mar. 9, 1999**

[54] **OVERSIZED DROP SHOULDER CREEPER WITH T-BAR SUPPORT**

[75] Inventors: **Ken Taylor**, Merced, Calif.; **Joseph J. Miles**, Plant City, Fla.

[73] Assignee: **United Auto System, Inc.**, Tampa, Fla.

[**] Term: **14 Years**

[21] Appl. No.: **77,211**

[22] Filed: **Sep. 29, 1997**

Related U.S. Application Data

[63] Continuation-in-part of Ser. No. 56,721, Jul. 8, 1996.

[51] **LOC (6) Cl.** **12-02**

[52] **U.S. Cl.** **D34/23**

[58] **Field of Search** D34/12-27; 280/32.5, 280/32.6, 79.11, 79.2, 79.7

References Cited

U.S. PATENT DOCUMENTS

- D. 230,971 3/1974 Shanklin .
- D. 242,909 1/1977 Miller .
- D. 259,243 5/1981 Argante .
- D. 270,962 10/1983 Martell .
- D. 271,717 12/1983 Linn .
- D. 285,018 8/1986 Quinonez .
- D. 289,815 5/1987 Quinonez .
- D. 293,160 12/1987 Le Droit .
- D. 296,597 7/1988 Adams .
- D. 298,374 11/1988 Hamrick .
- D. 299,076 12/1988 Whiteside .
- D. 301,078 5/1989 Szpot .

(List continued on next page.)

OTHER PUBLICATIONS

Whiteside Catalog No. 97; Whiteside Manufacturing Co, Inc.
 Matco Catalog; 1996-1997; pp. 402 & 403.
 California Car Cover Co. Catalog; California Car Cover Co.;
 "Catalog & Gift Guide Winter 1996".

Advertisement for Matco Tools; Matco Tools Christmas'96 Preview.
 Magazine; "Summit Racing Equipment"; Nov.-Dec. 1996; p. 176.
 Magazine; "Summit Racing Equipment"; Sep.-Oct. 1996; p. 158.
 Pamphlet; "Matco's Savings Speedway"; Matco Tools; Aug. 1996.
 Mac Tools; Aug. 1996; p. 23.
 Brochure; Mac Tools; "February Specials"; Feb. 1996; p. 2.
 Wholesale Tool Catalog; 1996; p. 747.
 Magazine; "Griot's Garage"; 1996; p. 32.

(List continued on next page.)

Primary Examiner—Kay H. Chin
Attorney, Agent, or Firm—Sam Silverberg

[57] CLAIM

The ornamental design for an oversized drop shoulder creeper with T-bar support, as shown and described.

DESCRIPTION

FIG. 1 is a top perspective view of an oversized drop shoulder creeper with T-bar Support showing our new design;
 FIG. 2 is a front elevation view of FIG. 1;
 FIG. 3 is a rear elevational view of FIG. 1;
 FIG. 4 is a left side elevational view of FIG. 1;
 FIG. 5 is a right side elevational view of FIG. 1;
 FIG. 6 is a top plan view of FIG. 1;
 FIG. 7 is a bottom plan view of FIG. 1;
 FIG. 8 is a right side elevational view of FIG. 1 showing a tilting headrest in a tiled position;
 FIG. 9 is a top perspective view of a second embodiment of the oversized drop shoulder creeper with T-bar support;
 FIG. 10 is a front elevational view of FIG. 9;
 FIG. 11 is a rear elevational view of FIG. 9;
 FIG. 12 is a left side elevational view of FIG. 9;
 FIG. 13 is a right side elevational view of FIG. 9;
 FIG. 14 is a top plan view of FIG. 9; and,
 FIG. 15 is a bottom plan view of FIG. 9; and,
 FIG. 16 is a right side elevational view of FIG. 9 showing a tilting headrest in a tilted position.

1 Claim, 10 Drawing Sheets

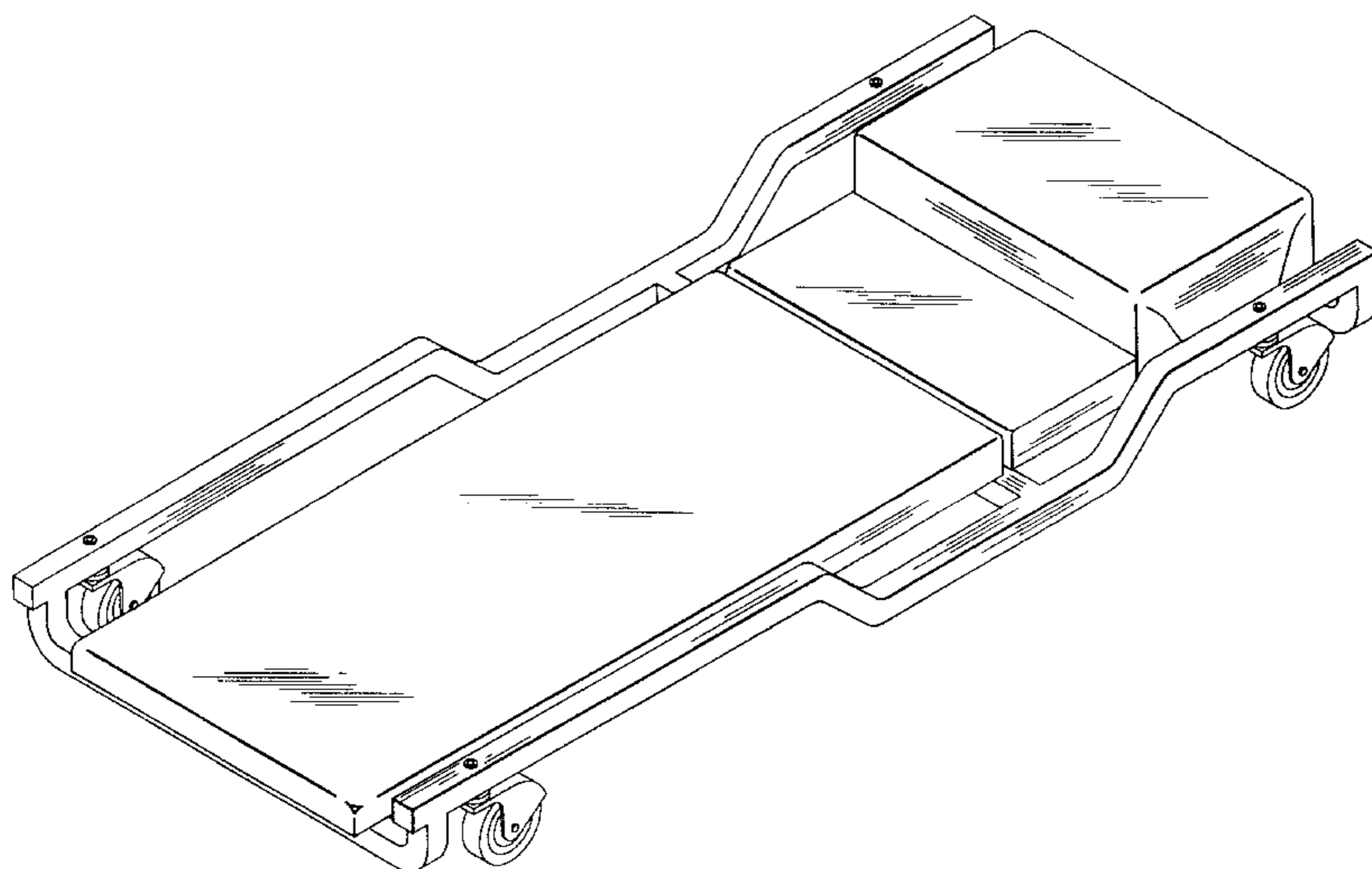

U.S. PATENT DOCUMENTS			OTHER PUBLICATIONS		
D. 301,791	6/1989	Osborne .	4,043,566	8/1977	Johnson .
D. 309,967	8/1990	Fagan .	4,066,151	1/1978	Liebscher et al. .
D. 319,717	9/1991	Schultz .	4,091,889	5/1978	Brown et al. .
D. 320,484	10/1991	Wallin .	4,168,076	9/1979	Johnson .
D. 321,072	10/1991	Bennett et al. .	4,185,846	1/1980	Black .
D. 321,578	11/1991	Gilbert .	4,244,594	1/1981	Hines .
D. 324,598	3/1992	Clark .	4,246,734	1/1981	Fogle, Jr. et al. .
324,617	8/1885	Walsh et al. .	4,373,409	2/1983	Benedek et al. .
D. 325,799	4/1992	Chen .	4,428,306	1/1984	Dresen et al. .
D. 330,619	10/1992	Gilbert et al. .	4,471,969	9/1984	Zabala et al. .
D. 330,957	11/1992	Contrini .	4,489,837	12/1984	Adair .
D. 335,733	5/1993	Zimmer .	4,564,216	1/1986	Kinyon et al. .
D. 351,707	10/1994	Pill .	4,570,957	2/1986	Rose .
D. 354,599	1/1995	Young .	4,580,799	4/1986	Quinonez .
D. 356,412	3/1995	Hensley, Jr. .	4,658,807	4/1987	Swain .
D. 361,421	8/1995	Garoutte .	4,698,731	10/1987	Johns, Sr. .
D. 367,628	3/1996	Bull .	4,704,777	11/1987	Schaefer et al. .
724,125	3/1903	Prindle .	4,706,519	11/1987	Beim .
920,553	5/1909	Farland et al. .	4,721,316	1/1988	Whiteside .
989,561	4/1911	Braham .	4,722,511	2/1988	Chitwood .
1,098,262	5/1914	Hollingshead .	4,789,047	12/1988	Knobloch .
1,104,398	7/1914	Zimmerman .	4,792,147	12/1988	Wissing .
1,132,983	3/1915	Shuey .	4,795,180	1/1989	Polcyn .
1,177,340	3/1916	Klein .	4,796,903	1/1989	Proctor et al. .
1,184,487	5/1916	Peterson .	4,815,569	3/1989	Norman .
1,195,014	8/1916	Hild .	4,862,765	9/1989	Schaefer et al. .
1,209,447	12/1916	Johnson .	4,863,178	9/1989	Friesen .
1,349,941	8/1920	Broome .	4,875,694	10/1989	Hamrick .
1,363,023	12/1920	Taylor .	4,886,050	12/1989	Lams et al. .
1,385,877	7/1921	McDonald .	4,895,380	1/1990	Brooks et al. .
1,394,493	10/1921	Grazer .	4,909,524	3/1990	Paine .
1,409,787	3/1922	Scarlett .	4,925,197	5/1990	Jones, Jr. .
1,431,383	10/1922	Edwards .	4,941,551	7/1990	Visser .
1,446,945	2/1923	Sunderland .	4,957,302	9/1990	Maxwell .
1,451,858	4/1923	Zengerle .	4,986,558	1/1991	Morris .
1,511,943	10/1924	Bush .	5,022,670	6/1991	Cote et al. .
1,643,268	9/1927	Burnwatt .	5,078,280	1/1992	Norden .
1,769,548	7/1930	Rodin .	5,099,951	3/1992	Stockwell .
1,785,646	12/1930	Pascoo .	5,108,118	4/1992	Schaevitz .
2,124,389	7/1938	Woelfer, Jr. .	5,174,592	12/1992	Pool .
2,148,199	2/1939	Heckman .	5,186,479	2/1993	Flowers .
2,154,952	4/1939	Mahloch .	5,195,763	3/1993	Scott et al. .
2,210,585	8/1940	Hulbert .	5,213,350	5/1993	Hermanson .
2,228,568	6/1941	Holmes .	5,217,315	6/1993	Rosane .
2,246,628	6/1941	Heckman .	5,251,359	10/1993	Finkl .
2,291,094	7/1942	McCarthy .	5,277,683	1/1994	Wilkins .
2,332,089	10/1943	Knight .	5,297,809	3/1994	Chen .
2,424,032	7/1947	Henderson .	5,299,826	4/1994	Flowers .
2,456,002	12/1948	Jonette .	5,330,209	7/1994	Pool .
2,487,706	11/1949	Happ .	5,330,211	7/1994	Nicholson .
2,509,934	5/1950	Murray .	5,333,709	8/1994	Bulgrien .
2,595,783	5/1952	Griffin .	5,364,201	11/1994	LeBarre .
2,650,374	9/1953	Pierce .	5,378,003	1/1995	Burd et al. .
2,684,734	7/1954	Wilson .	5,380,021	1/1995	Doherty .
2,716,181	8/1955	Ritter .	5,392,201	2/1995	Morley et al. .
2,729,905	1/1956	Crozier .	5,397,139	3/1995	Simpson .
2,780,472	2/1957	Weldon, Sr. .	5,407,170	4/1995	Silvon et al. .
2,782,045	2/1957	Hulbert .	5,413,544	5/1995	Fiore .
2,879,865	3/1959	Simmons .	5,419,945	5/1995	Lopez .
2,908,472	10/1959	McDonald .	5,451,068	9/1995	Shockley .
2,942,693	6/1960	Johnson .	5,460,305	10/1995	Ahearn .
3,092,394	6/1963	Burke .	5,460,392	10/1995	Hansen .
3,313,377	4/1967	Aninger .	5,494,305	2/1996	Chen .
3,361,437	1/1968	Loftis .	5,503,415	4/1996	Powell .
3,757,704	9/1973	Allgeyer et al. .	5,527,051	6/1996	Plaza .
3,799,566	3/1974	Thompson .			
3,818,542	6/1974	Jones .			
3,970,325	7/1976	Wirsig .			
3,976,155	8/1976	Esch .			
3,984,116	10/1976	Bowers .			

Flyer; Mac Tools; May 1995; p. 12.

Flyer; Mac Tools; Apr. 1995; p. 14.

Magazine; "Griot's Garage"; Spring 1995; p. 44

“The Only Creeper Strong Enough to Stand up to the Intimidator”.

Snap-on Catalog; “Snap-on Anniversary 75 Years”; Issued Jan. 1995; p. 228.

Mac Tools Catalog; Issued Jan. 1995; pp. 260 & 261.

Advertisement for Creepers for Mac Tools; 1994.

Whiteside Catalog 92; Whiteside Manufacturing Co., Inc.

Advertisement for Creepers for Lisle; “World’s Toughest Creepers!”; 1992.

Whiteside Catalog No. 89; Whiteside Manufacturing Co. Inc. “Roll Over Creepers and Other Related Products”.

Pamphlet; “Lisle: Specialty Automotive Tools”; T-81/54.

Matco Tools PL0696; Price List-Order Form; p. 16.

Brochure; Larin Corporation; p. 11.

Advertisement for “The Bone”; Pegasus Products Co.

Advertisement for creepers for snap-on and United Auto Systems, Inc.; “The Only Creeper Strong Enough to Stand up to the Intimidator”.

Fleet Products Catalog; p. 31.

American Tool & Equipment Catalog; p. 4.

JC Whitney Catalog No. 205R; p. 39.

Brookstone Tools Catalog; p. 30.

Brochure; R.E.L. Products, Inc.; “Mechanics Creepers; Mechanic Seats; Counter Stools; Portable Benches; Casters”.

Advertisement for Creeper Seat for K-Mart;

Magazine; “Solutions, Products that Make Life Easier”.

Lisle Catalog T-52; pp. 44-46.

Brookins Service Equipment and Balcrank KWIK-Sell lubrication Equipment Catalog No. 4146; “Professional Automotive Service and Kwik-Sell lubrication Equipment”; p. 15.

Brochure; “Mechanics Creepers that Perform”; R.E.L. Products, Inc.

Brochure; “Quality Products Creepers; Roller Seat; Casters”; P& B Manufacturing Co.

Advertisement for “Sky Creeper”; Basic, Inc.

Advertisement for “Roll-A-Lite” Lighted Floor Creeper.

Snap-on Magazine; Snap-on Tools; “Uninterrupted Innovation for Close to Three Quarters of a Century”; p. 19.

Advertisement for “Creeper Rack”; Snap-on Tools.

Advertisement for “Lady Luck” Screwdriver; United Auto Systems, Inc.

Attachment A.

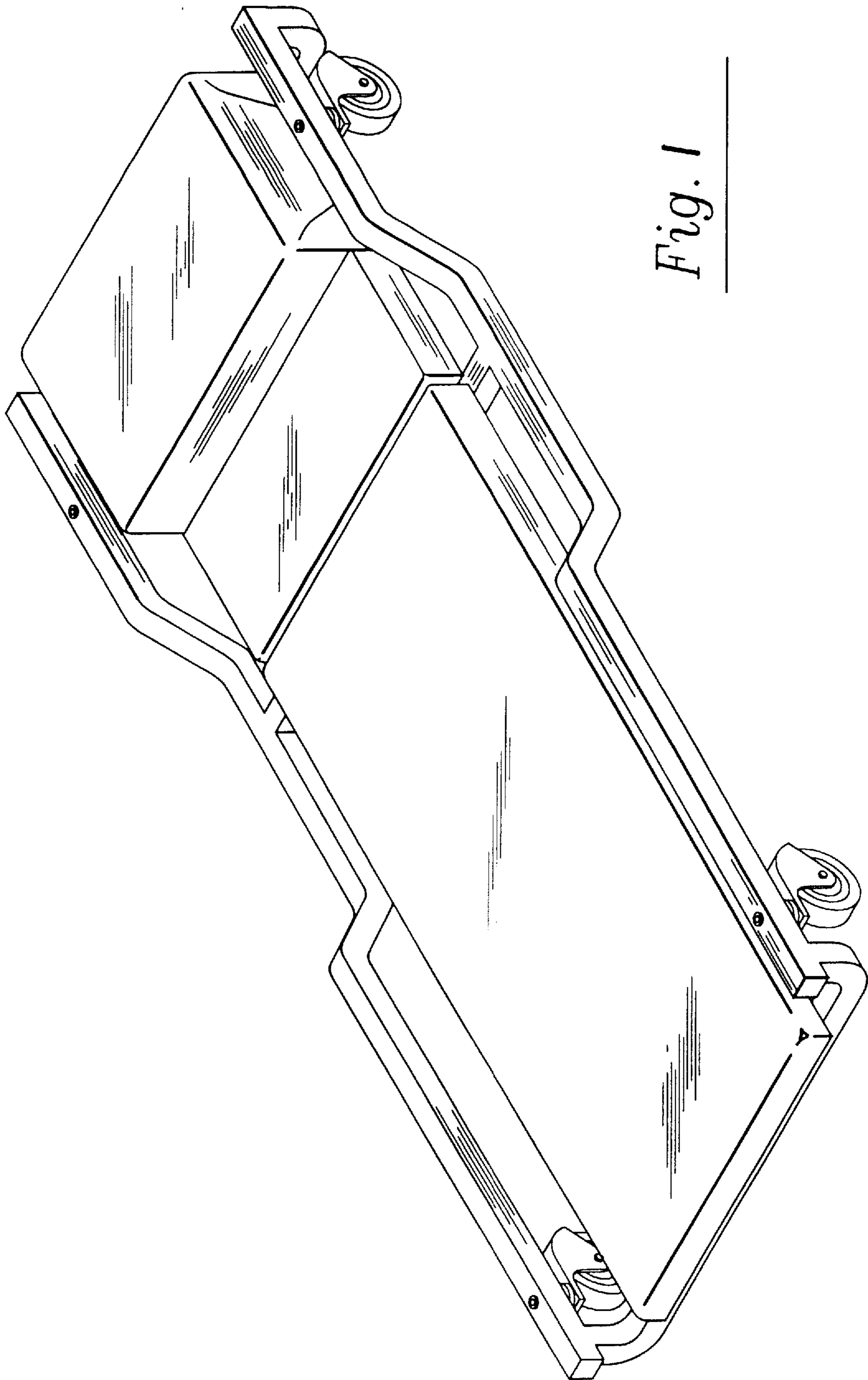

Fig. 1

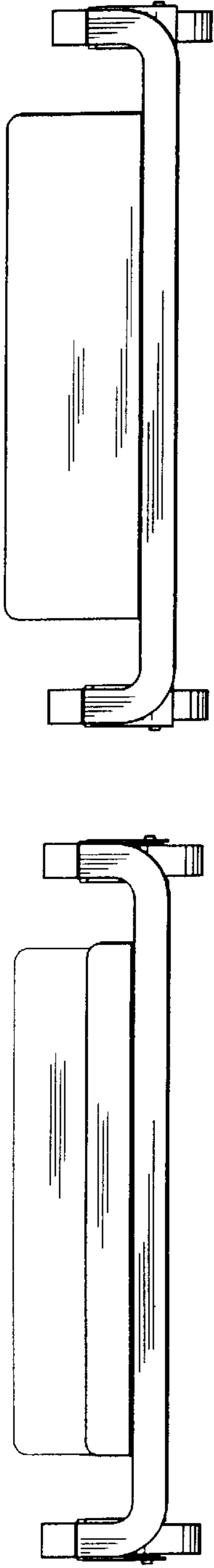

Fig. 3

Fig. 2

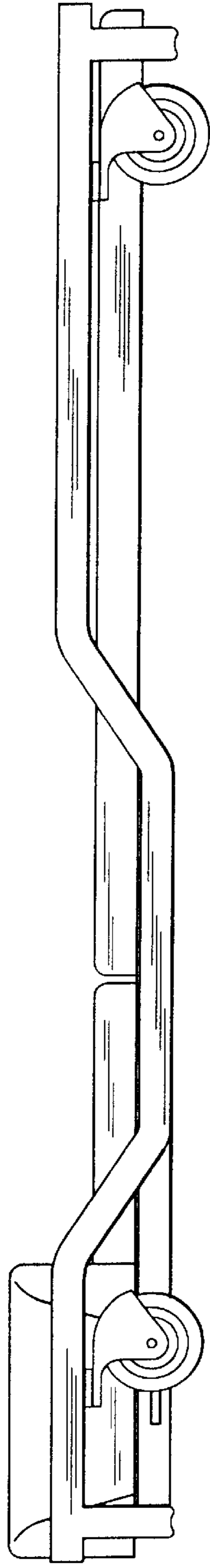

Fig. 4

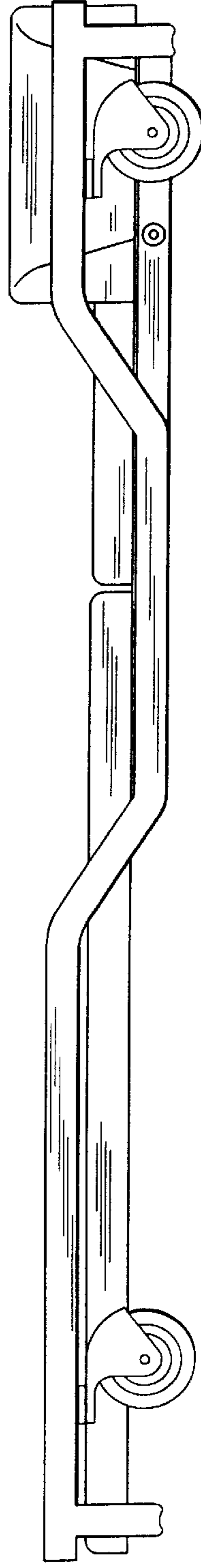

Fig. 5

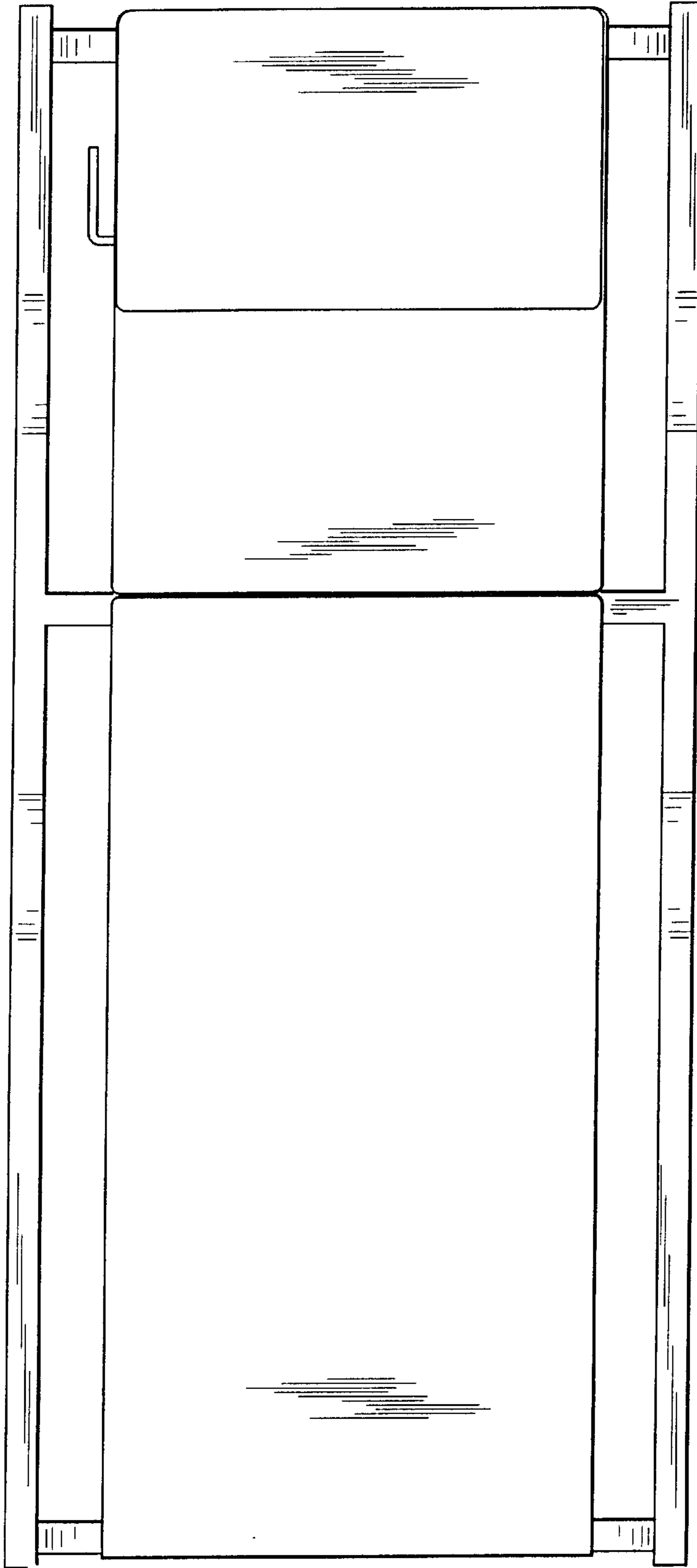

Fig. 6



Fig. 7

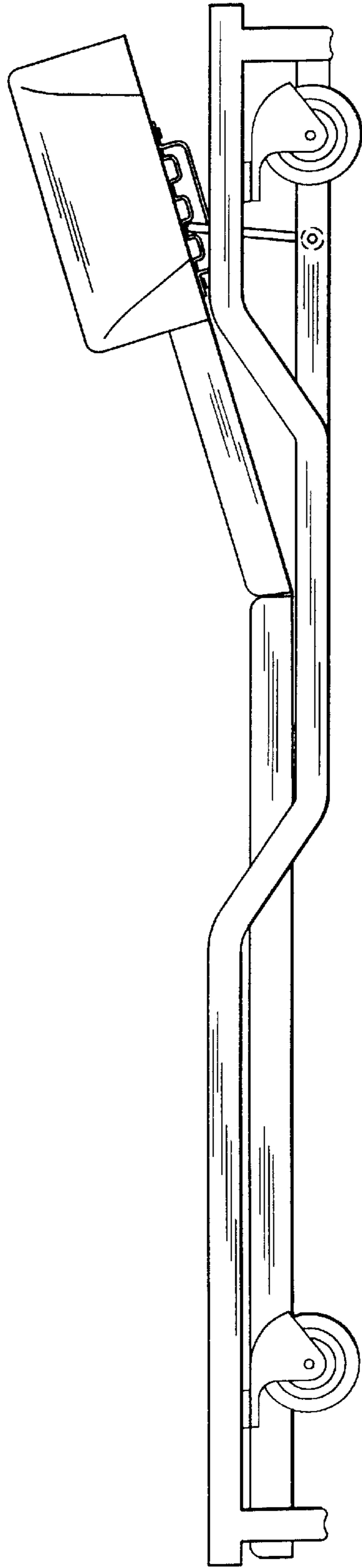

Fig. 8

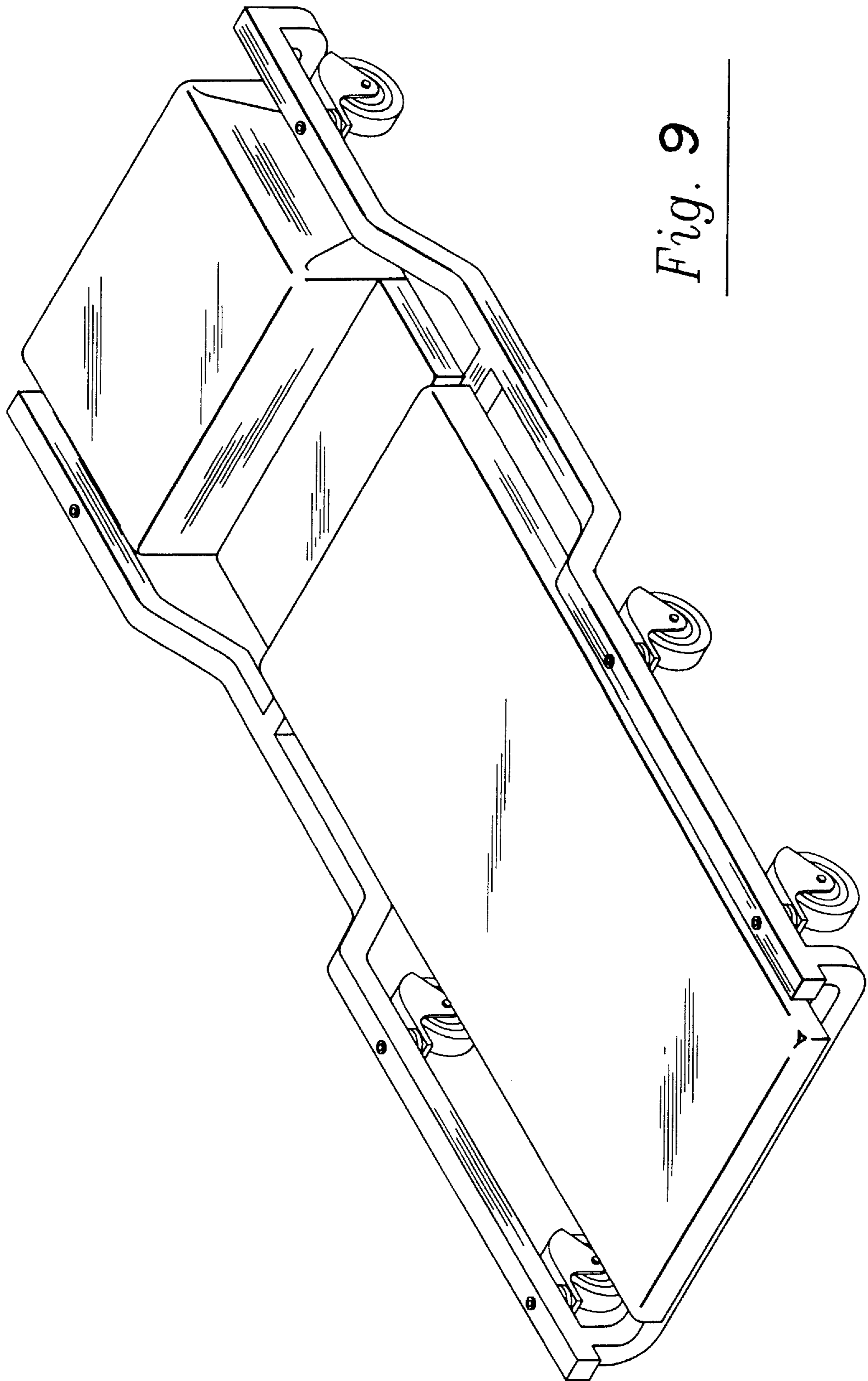

Fig. 9

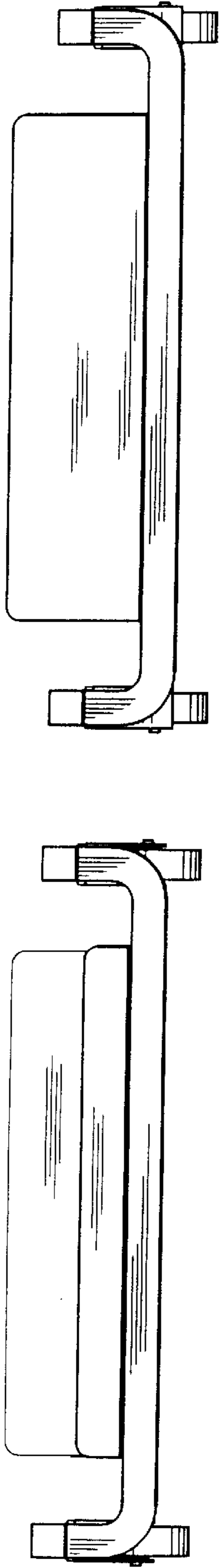

Fig. 10

Fig. 11

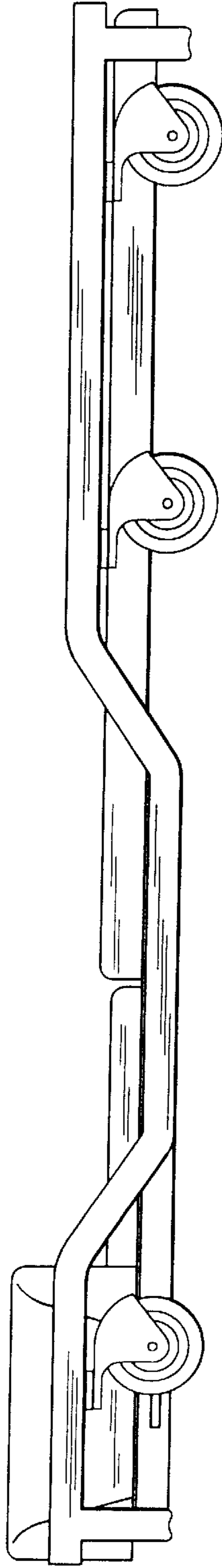

Fig. 12

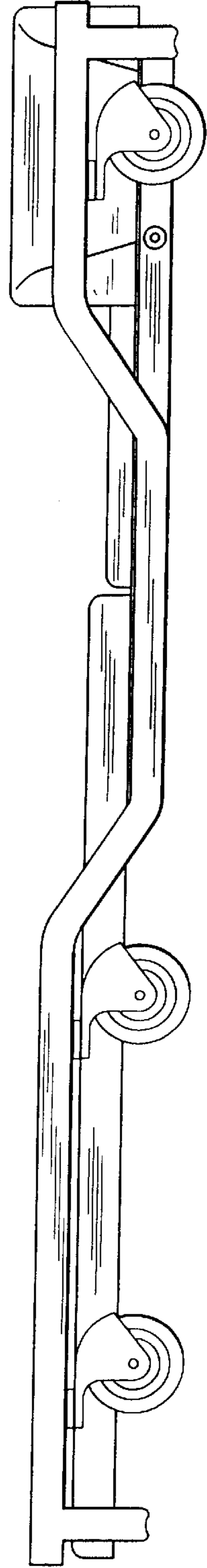

Fig. 13

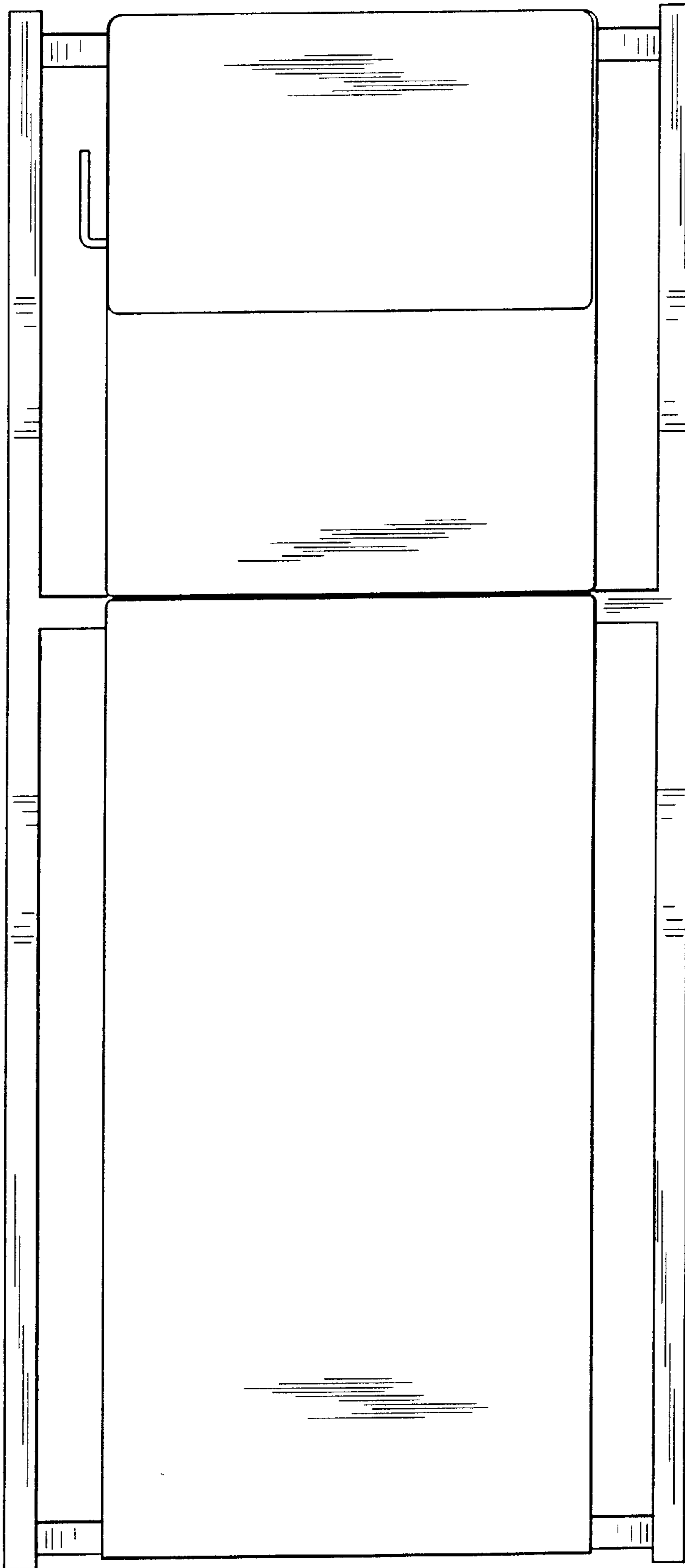

Fig. 14

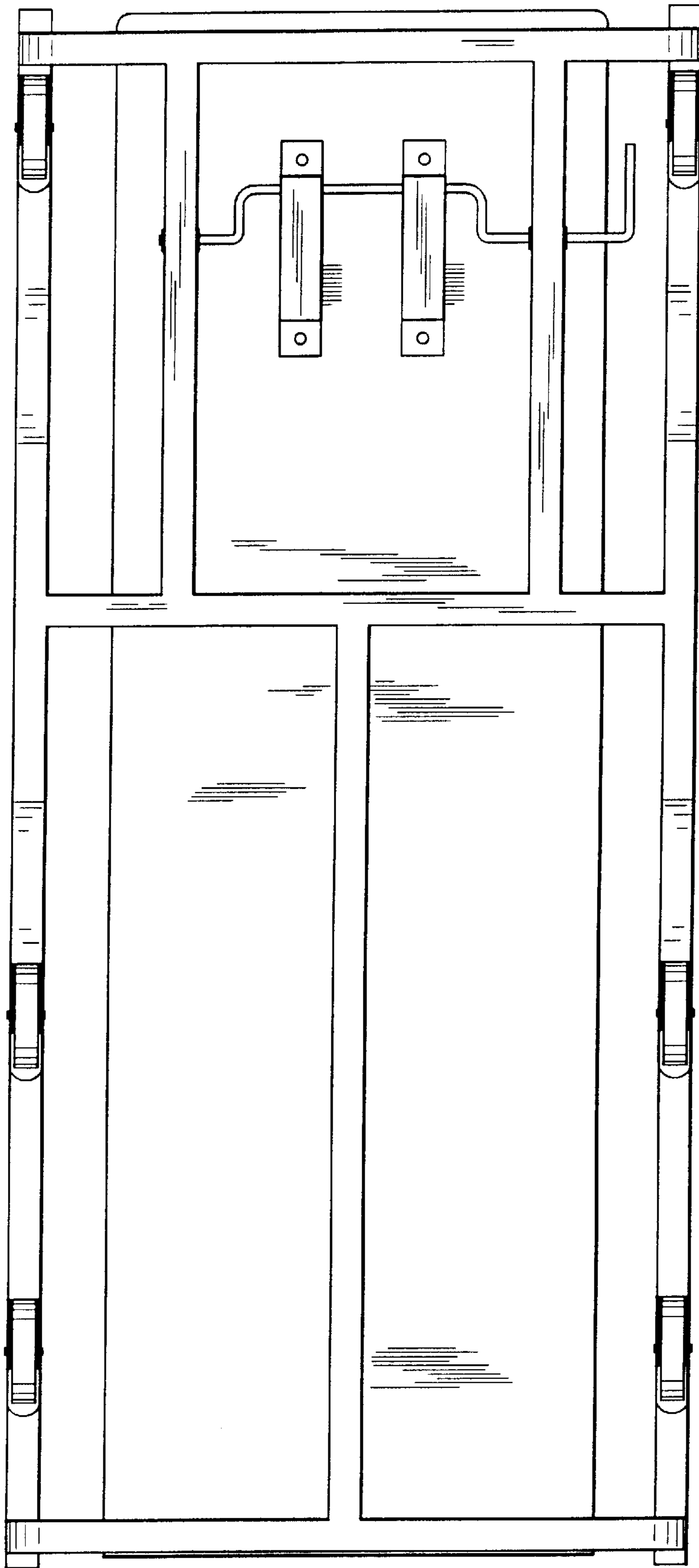

Fig. 15

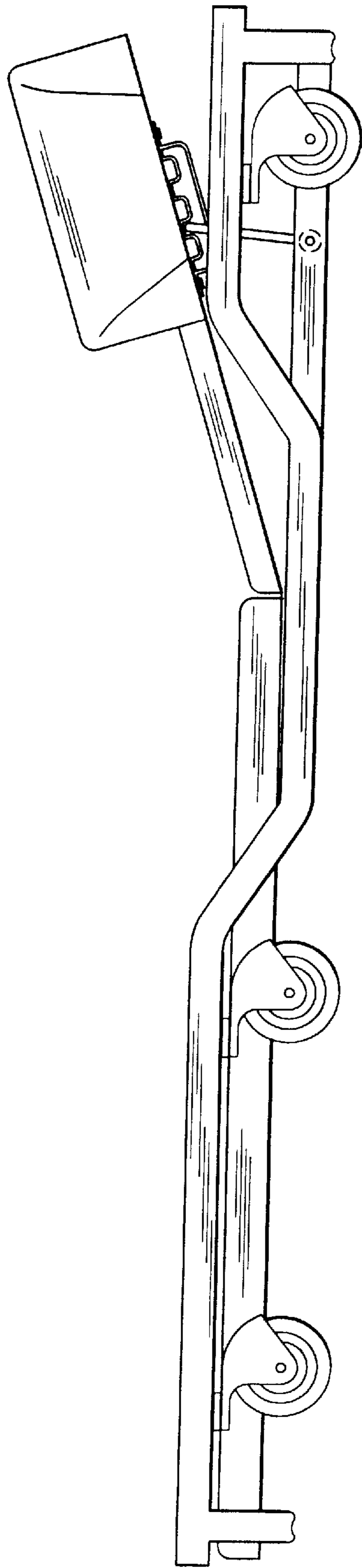

Fig. 16