



US00D406574S

United States Patent [19]
Eckley et al.

[11] **Patent Number: Des. 406,574**

[45] **Date of Patent: **Mar. 9, 1999**

[54] **PAYMENT INSTRUMENT**

[75] Inventors: **Gordon P. Eckley**, Foresthill; **Jeffrey P. Hill**, Granite Bay; **Jeffrey K. Sasaki**, Redwood City, all of Calif.

[73] Assignee: **VeriFone, Inc.**, Santa Clara, Calif.

[**] Term: **14 Years**

[21] Appl. No.: **77,639**

[22] Filed: **Oct. 6, 1997**

[51] **LOC (6) Cl.** **14-02**

[52] **U.S. Cl.** **D14/105; D18/4**

[58] **Field of Search** D14/100, 105,
D14/107, 118; D18/36, 37, 39, 4; 355/64,
65, 75, 81; 250/556; 235/380, 382, 7 R,
382.5, 472, 482; 382/312, 313; 902/22;
348/150

[56] **References Cited**

U.S. PATENT DOCUMENTS

D. 289,819 5/1987 Long D99/28

D. 298,944 12/1988 Stark et al. D14/105
D. 340,919 11/1993 Lee D14/105
D. 362,239 9/1995 Je D14/105
D. 367,044 2/1996 Arakaki D14/105
D. 367,472 2/1996 Clark et al. D14/105

Primary Examiner—Freda Nunn
Attorney, Agent, or Firm—Sanford E. Warren, Jr.

[57] **CLAIM**

The ornamental design for the payment instrument, as shown and described.

DESCRIPTION

FIG. 1 is a perspective view of a payment instrument showing our new design;
FIG. 2 is a top plan view thereof;
FIG. 3 is a bottom plan view thereof;
FIG. 4 is a front elevation view thereof;
FIG. 5 is a rear elevation view thereof;
FIG. 6 is a left side elevation view thereof; and,
FIG. 7 is a right side elevation view thereof.

1 Claim, 3 Drawing Sheets

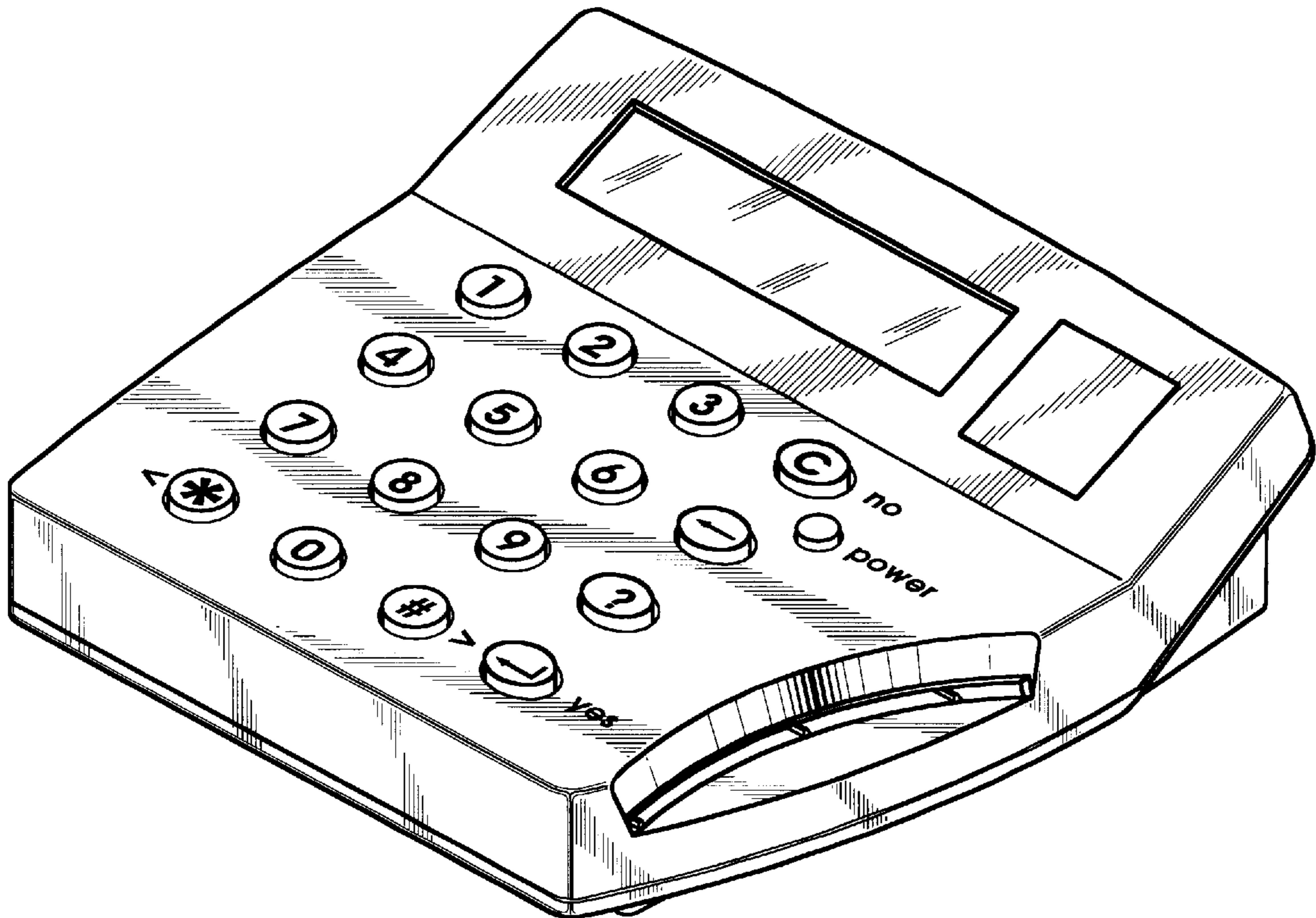

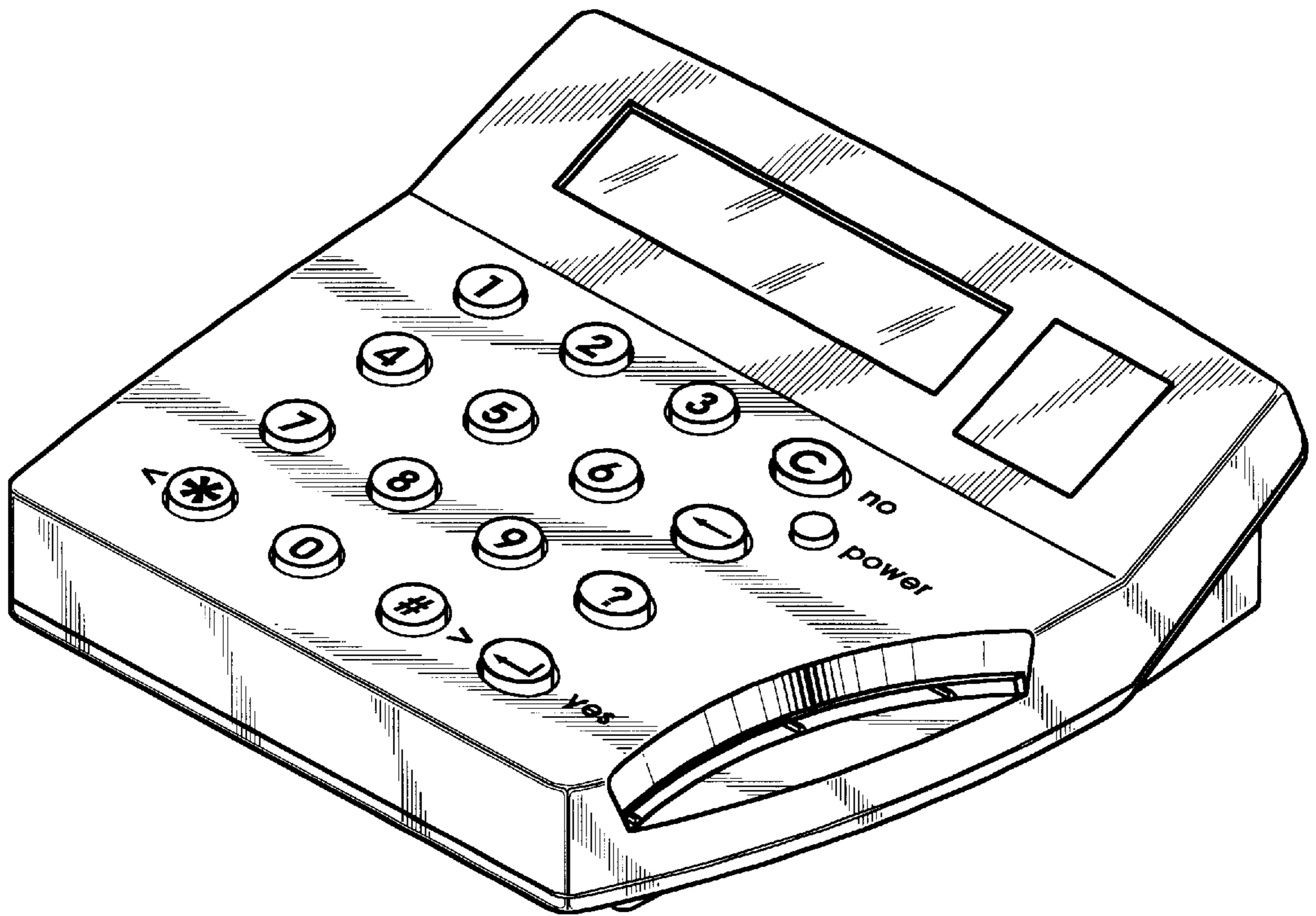

Fig.1

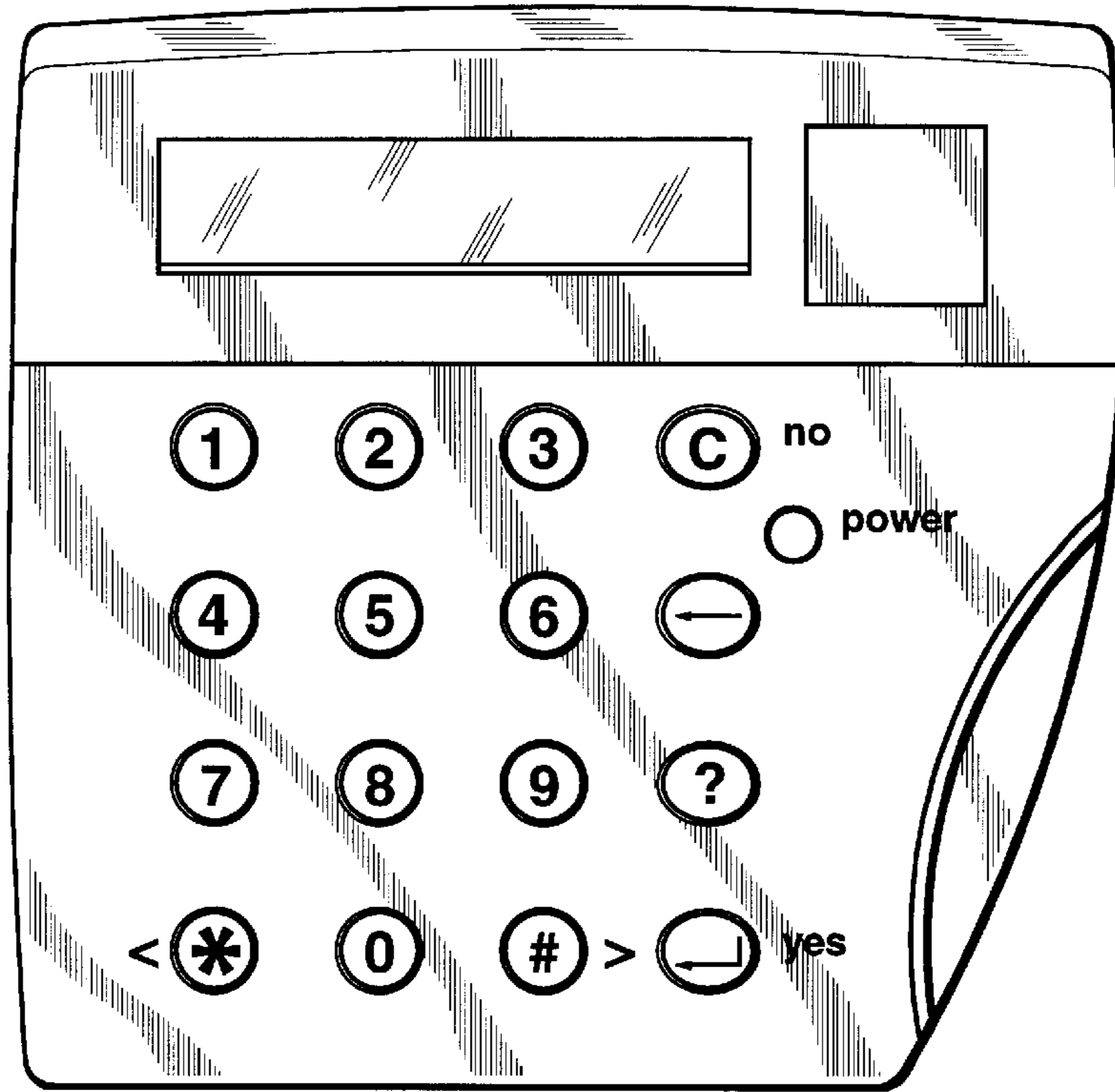

Fig.2

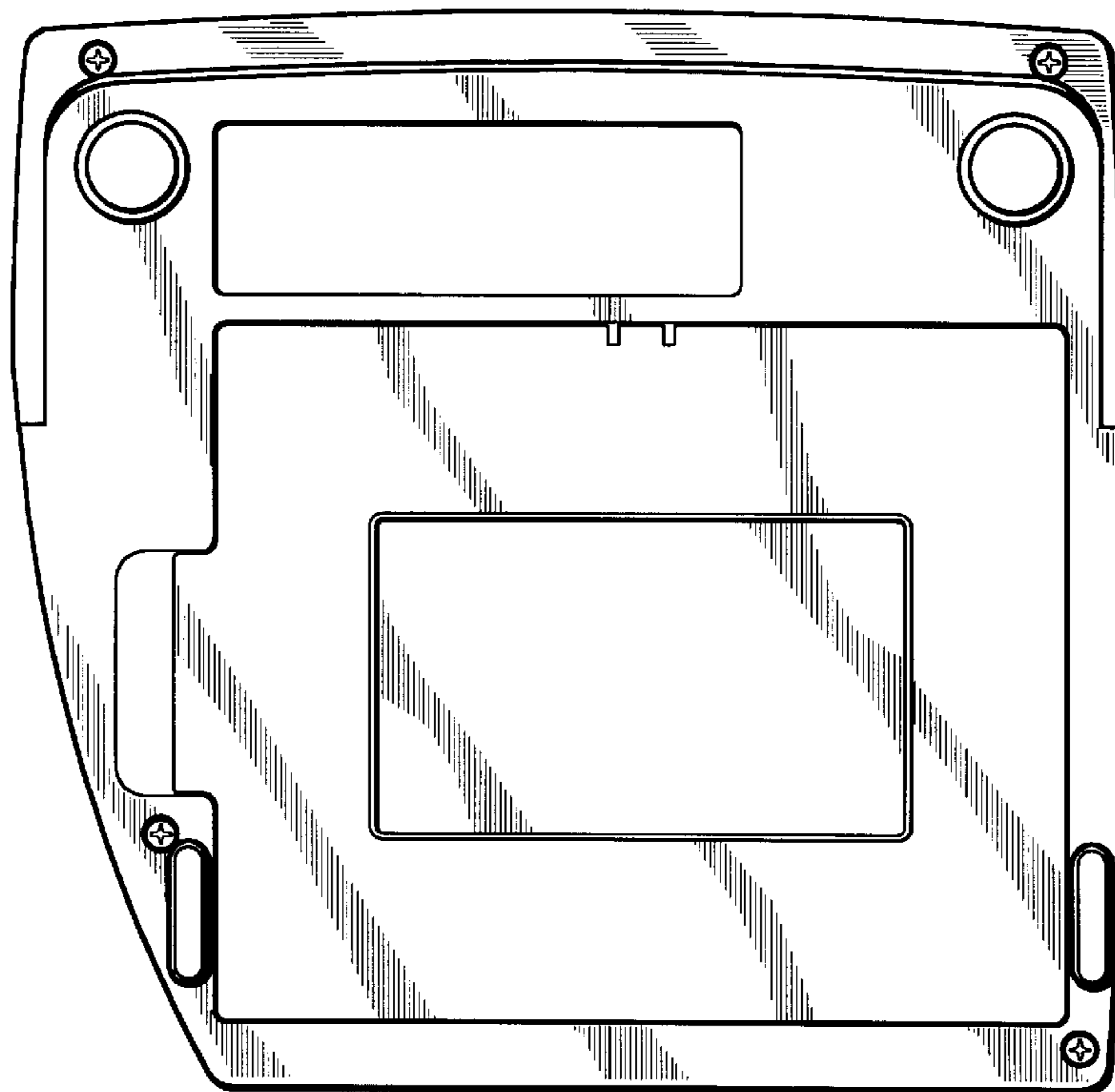

Fig.3

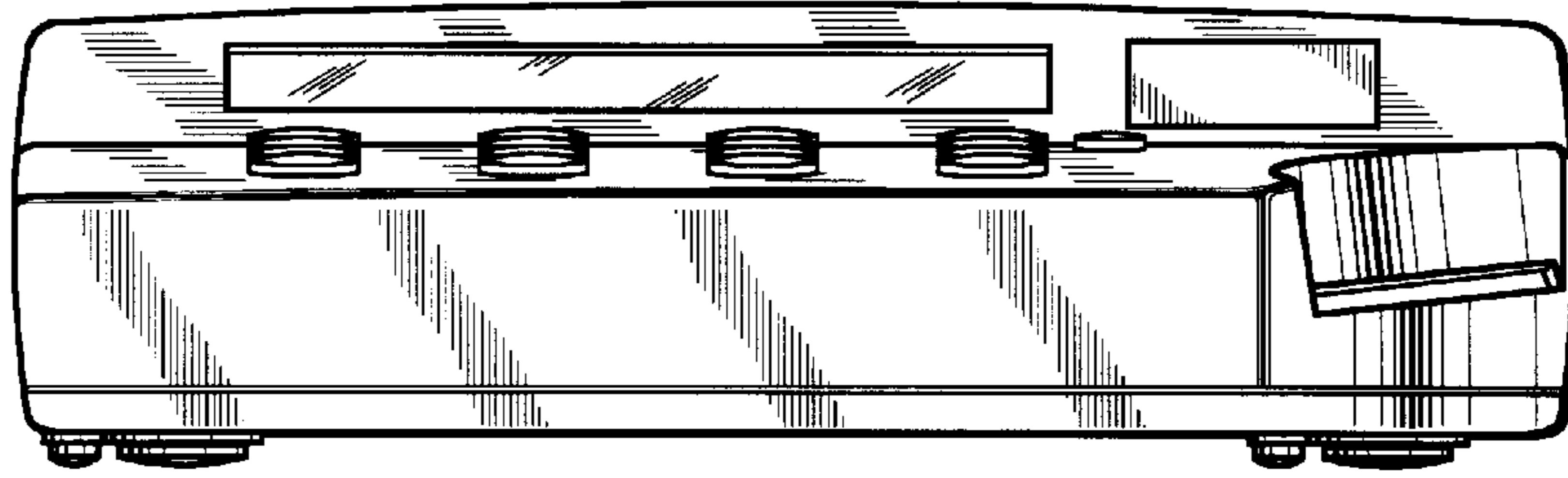

Fig.4

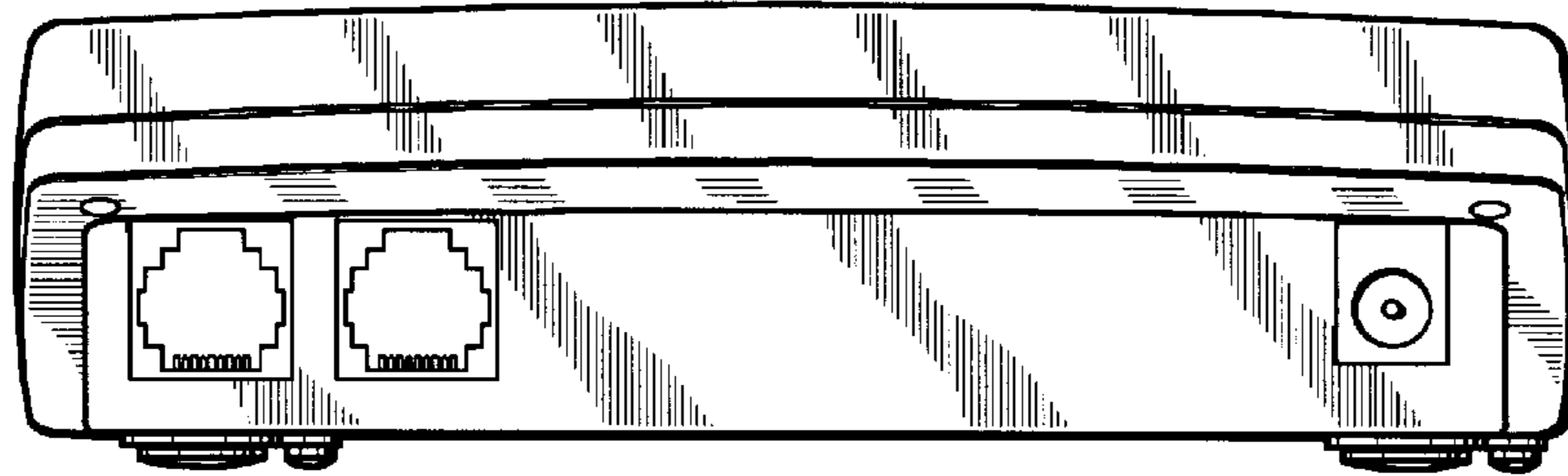

Fig.5

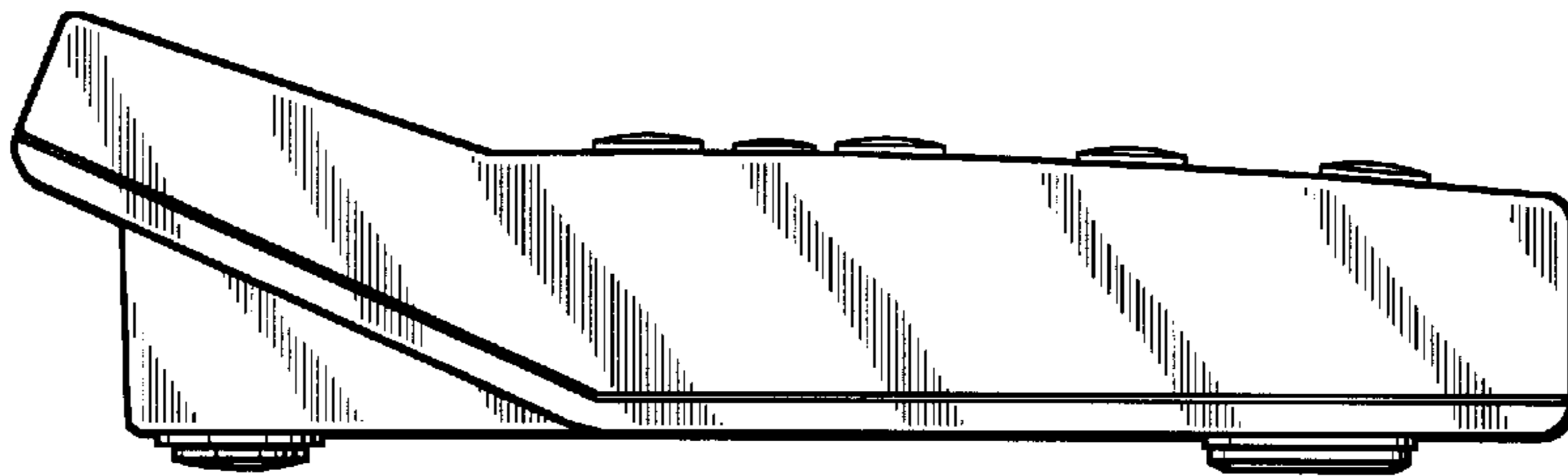

Fig.6

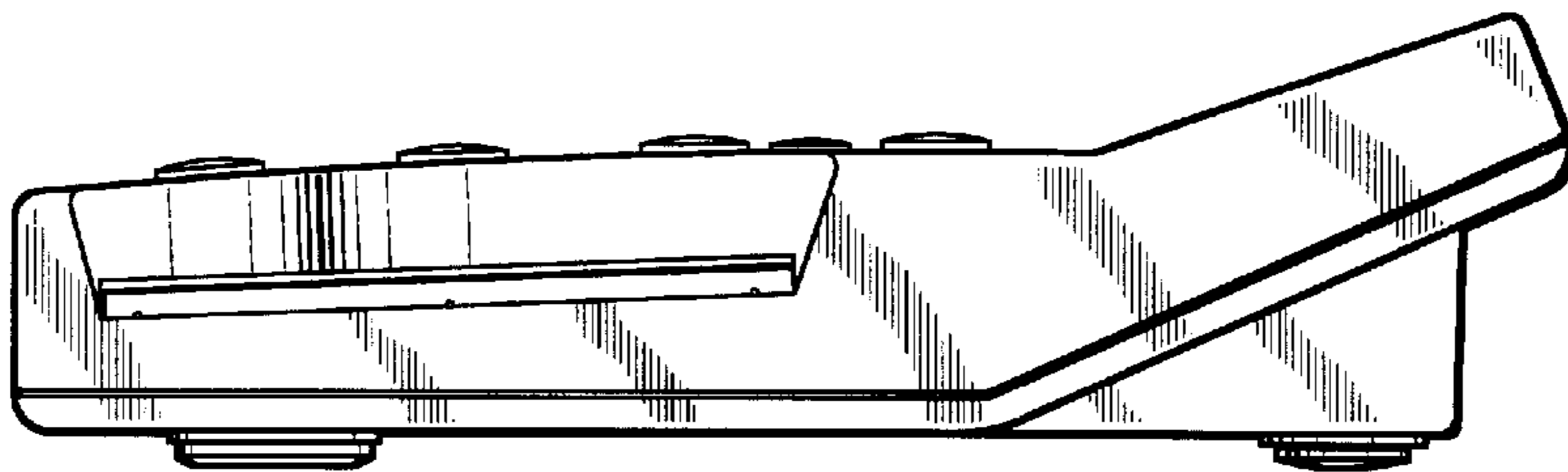

Fig.7