

US00D406485S

United States Patent [19]

Paikos et al.

[11] **Patent Number: Des. 406,485**

[45] **Date of Patent: **Mar. 9, 1999**

[54] **HAMMER HOLDER**

[76] Inventors: **George P. Paikos**, 27795 Avenue Hopkins, Valencia, Calif. 91355;
Michael C. F. Chen, No. 17 Kung 6 Road, Lin-Kou 2nd Industrial Park, Taipai, Hsien, Taiwan

[**] Term: **14 Years**

[21] Appl. No.: **81,396**

[22] Filed: **Dec. 31, 1997**

Related U.S. Application Data

[63] Continuation-in-part of Ser. No. 77,625, Oct. 7, 1997, and a continuation-in-part of Ser. No. 60,251, Sep. 25, 1996, Pat. No. Des. 392,826.

[51] **LOC (6) Cl. 08-08**

[52] **U.S. Cl. D6/566**

[58] **Field of Search** D6/566, 512, 552, D6/553, 567; D8/349, 354, 356, 567, 370, 373; 211/13, 30, 70.5, 86, 87, 181; 248/302, 304, 309.1, 312

[56] References Cited

U.S. PATENT DOCUMENTS

D. 153,957 5/1949 Linnard D6/566

D. 281,221 11/1985 Edmiston D8/373 X
D. 301,406 6/1989 Barbieri et al. D6/566
4,143,845 3/1979 Harris 248/302 X
4,421,238 12/1983 Patton 211/13

OTHER PUBLICATIONS

Photographs of specimen of a hammer holder manufactured by Ho Yin Yee of Taiwan and distributed in the United States (Prior to filing date).

Primary Examiner—Brian N. Vinson
Attorney, Agent, or Firm—David Weiss

[57] CLAIM

The ornamental design for a hammer holder, as shown and described.

DESCRIPTION

FIG. 1 is a front, side perspective view of a hammer holder showing our new design;
FIG. 2 is a left side elevation view thereof, the right side being a mirror image;
FIG. 3 is a top plan view thereof;
FIG. 4 is a bottom plan view thereof;
FIG. 5 is a front elevation view thereof; and,
FIG. 6 is a rear elevation view thereof.

1 Claim, 1 Drawing Sheet

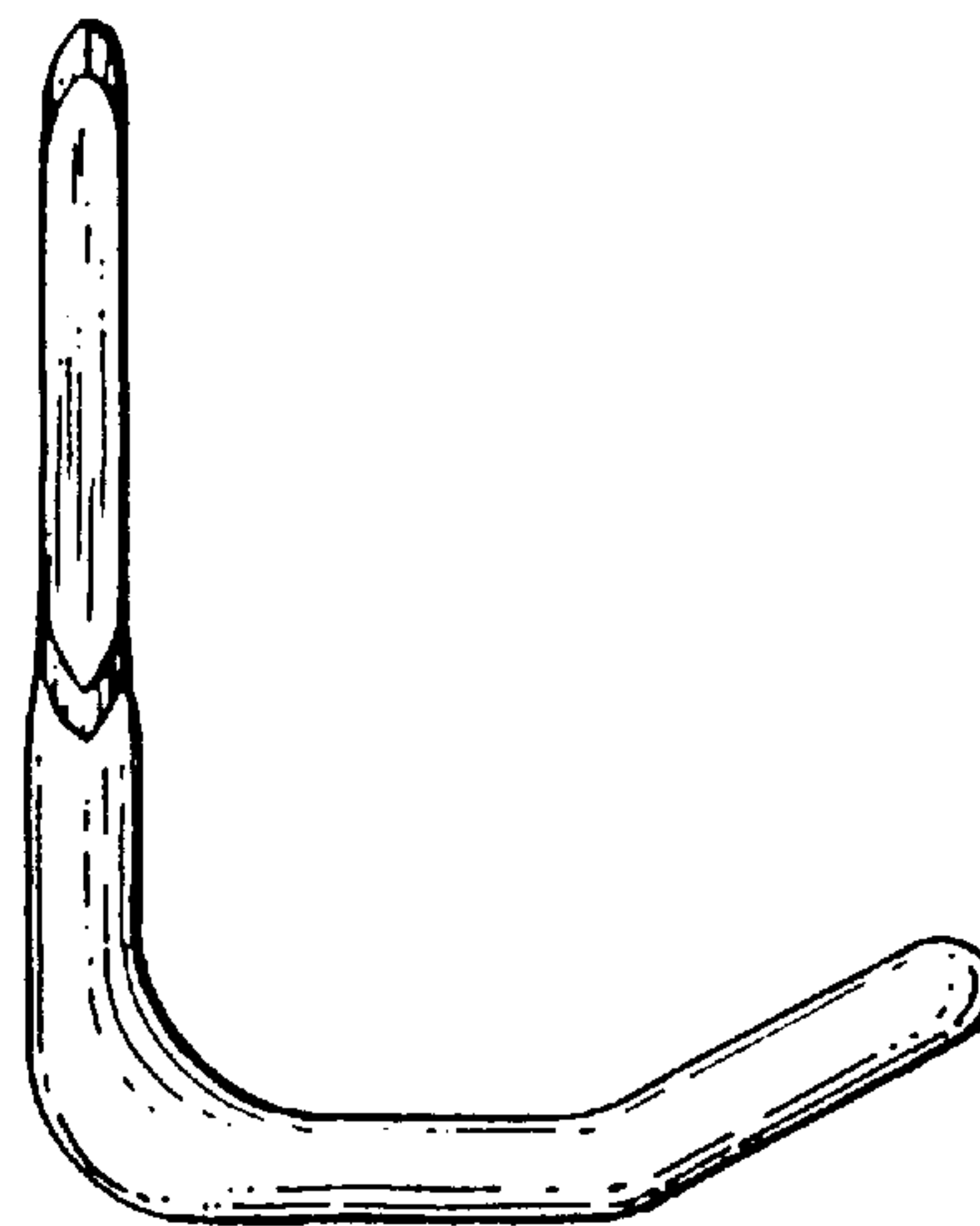
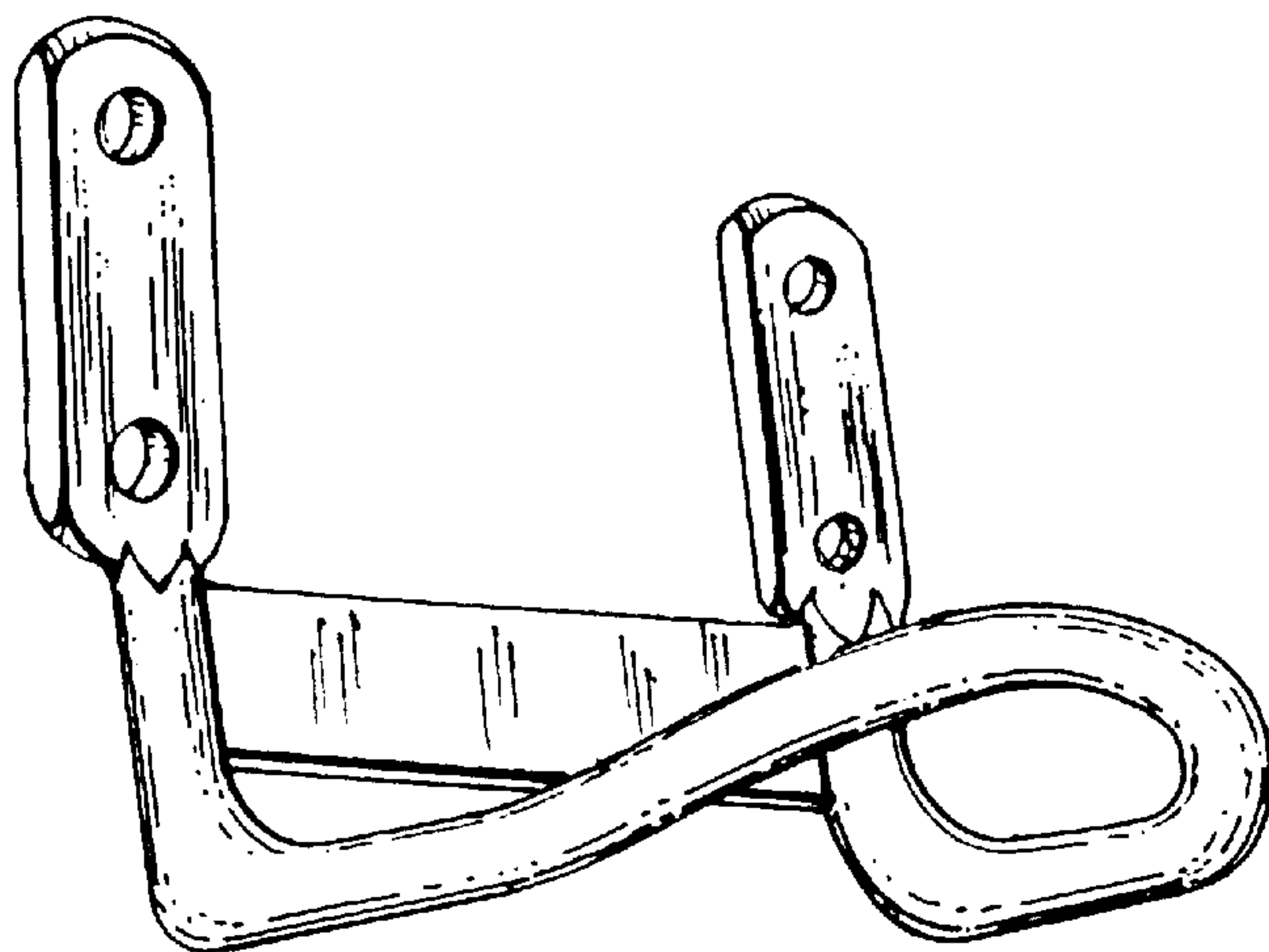

Fig. 1.

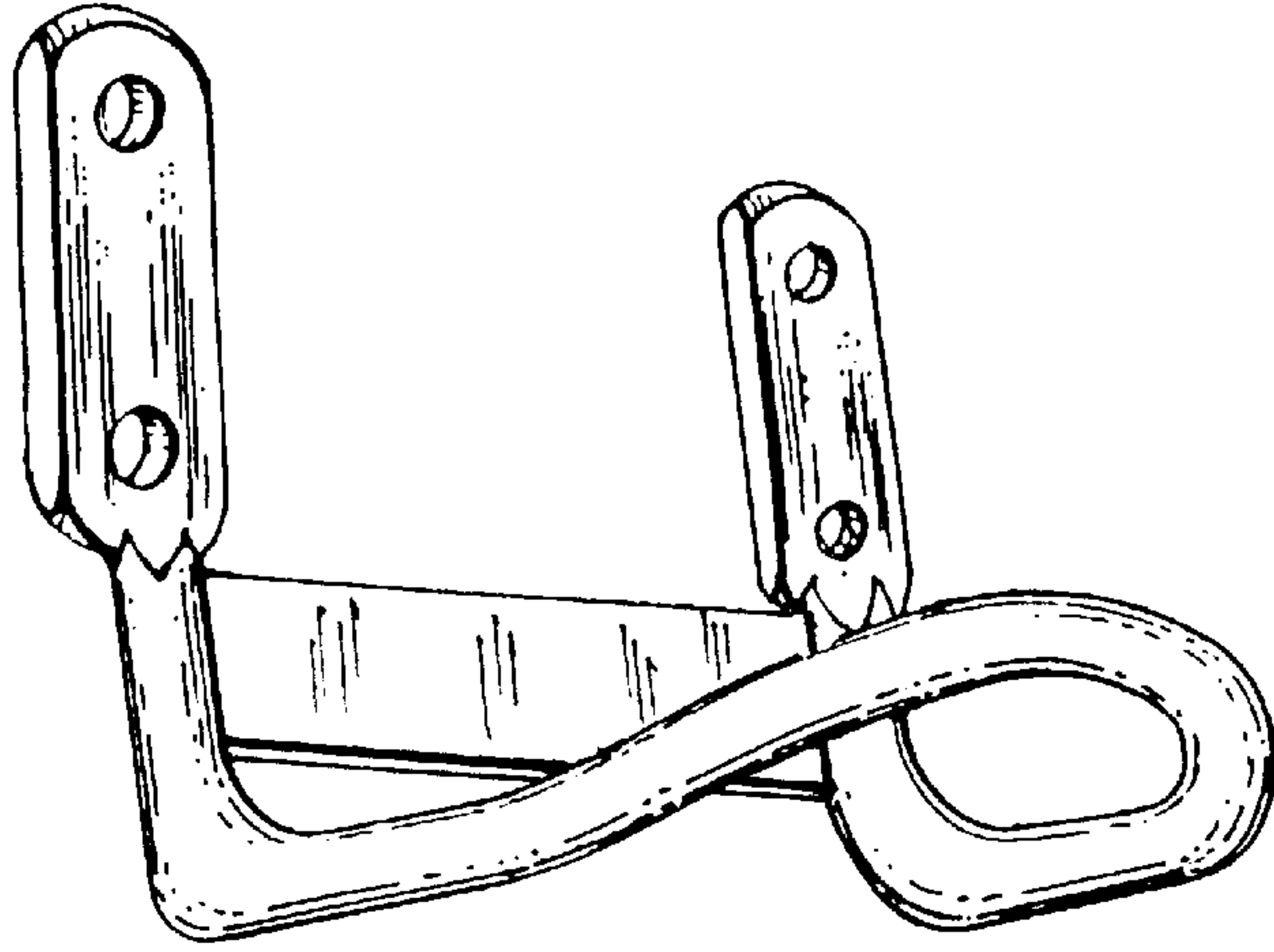

Fig. 2.

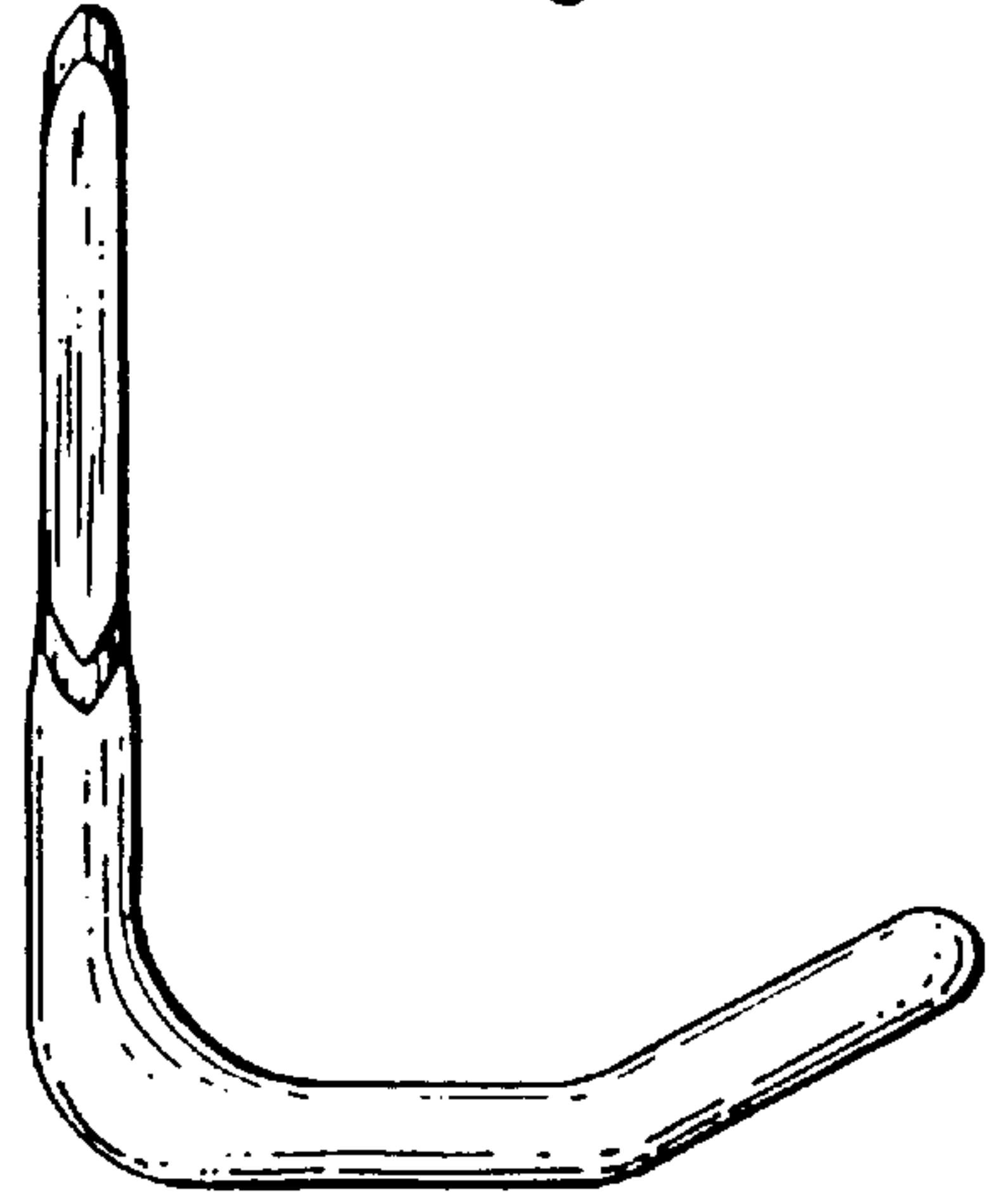

Fig. 3.

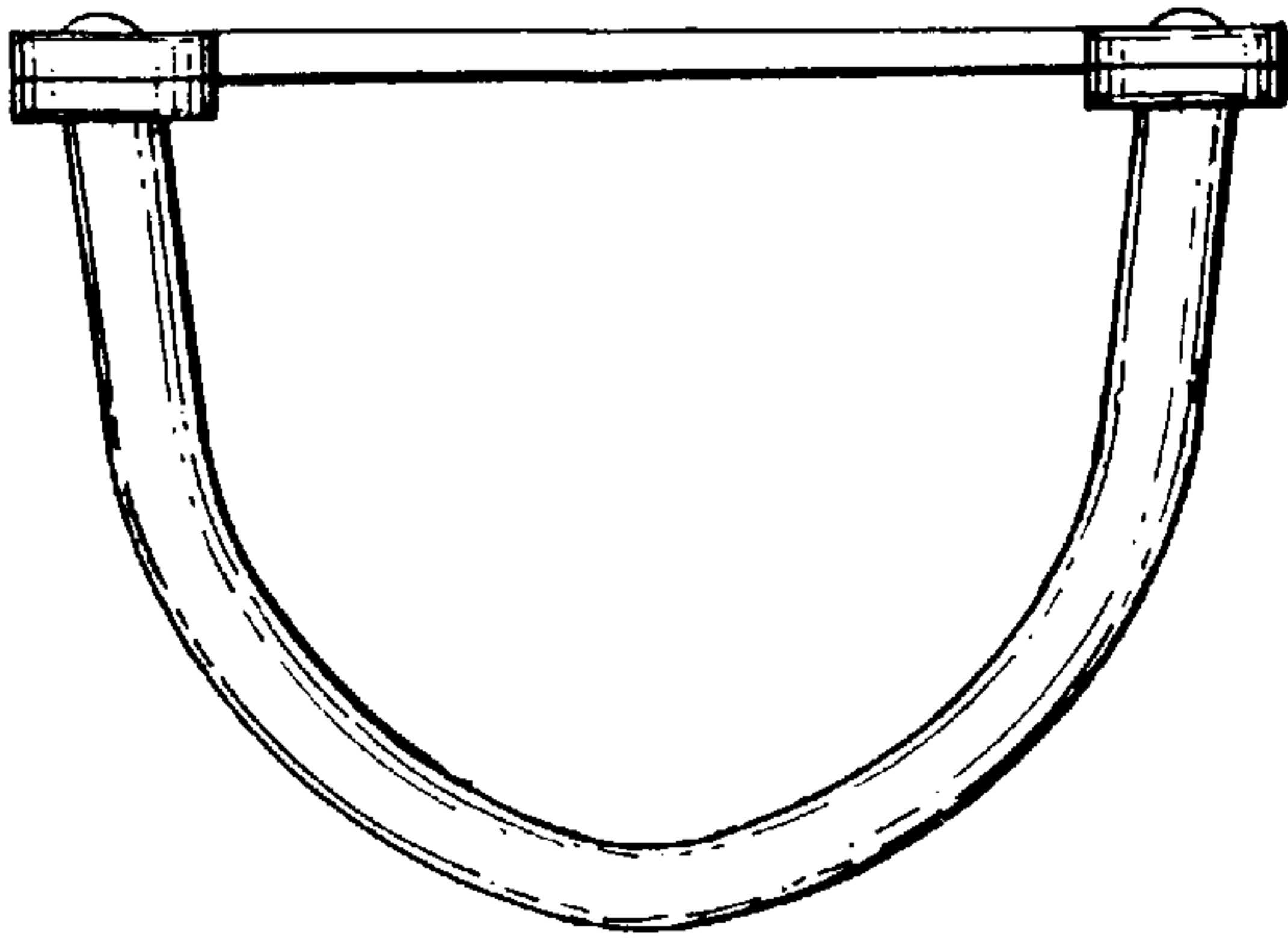

Fig. 4.

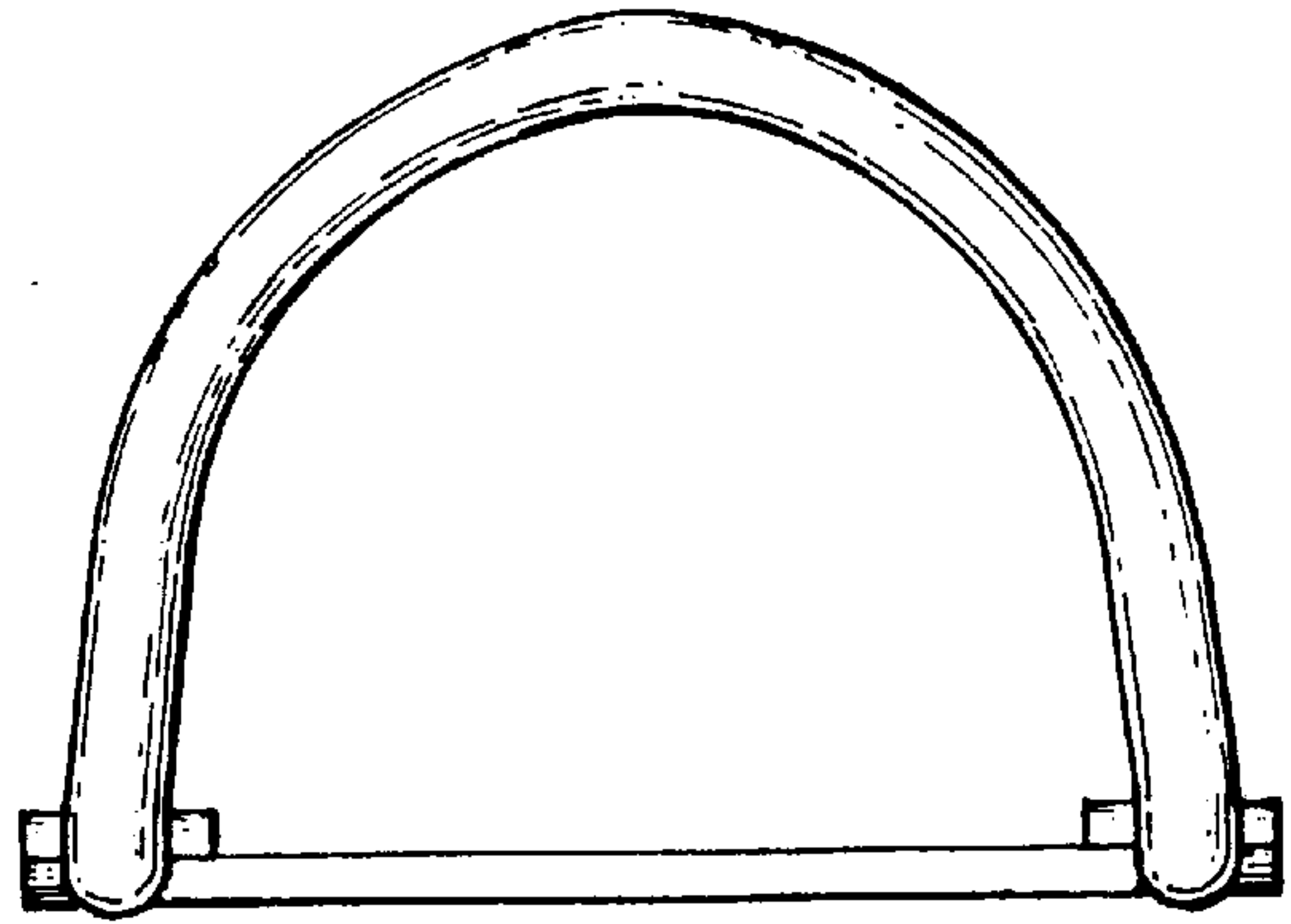

Fig. 5.

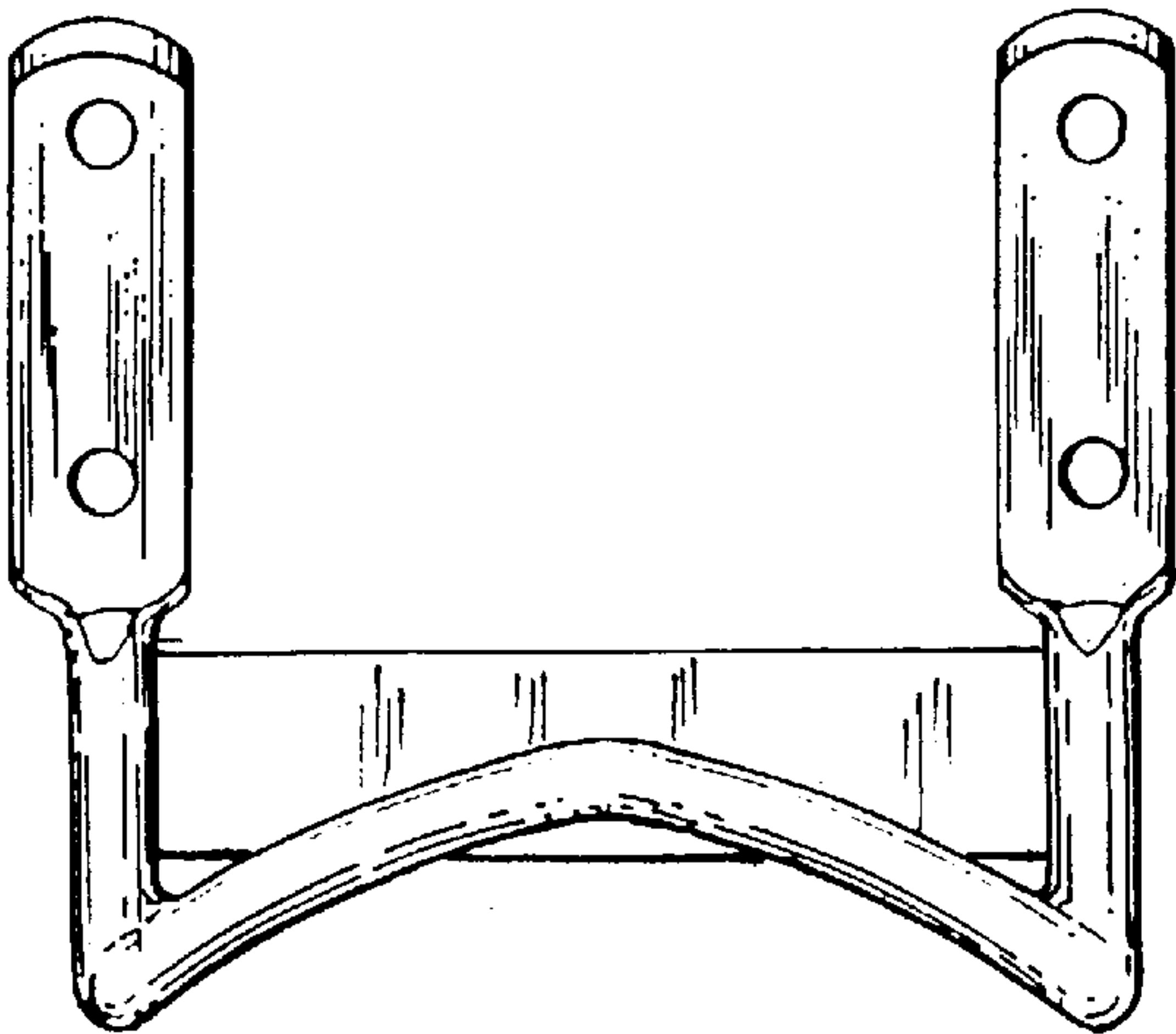

Fig. 6.

