



US00D406413S

United States Patent [19]

[11] **Patent Number: Des. 406,413**

Russo

[45] **Date of Patent: **Mar. 2, 1999**

[54] **HORSE MUCKING RAKE**

[75] Inventor: **Anthony N. Russo**, 22 Welisewitz Rd., Ringoes, N.J. 08551

[73] Assignee: **Anthony N. Russo**, Ringoes, N.J.

[**] Term: **14 Years**

[21] Appl. No.: **71,104**

[22] Filed: **May 21, 1997**

[51] **LOC (6) Cl. 30-99**

[52] **U.S. Cl. D30/162; D8/13**

[58] **Field of Search D30/162; 294/55, 294/1.3, 1.4; 248/101; 119/801, 795, 858; D7/687, 686; D8/13, 10**

[56] **References Cited**

U.S. PATENT DOCUMENTS

D. 312,030	11/1990	Brignull	D8/13
D. 314,254	1/1991	Gordon	D30/162
D. 332,675	1/1993	Simon	D30/162
D. 347,497	5/1994	VanSkiver	D30/162
427,055	5/1890	Cushing .	
929,479	7/1909	Parker .	
1,014,250	1/1912	Norman .	
1,209,060	12/1916	Snyder .	
1,267,778	5/1918	Leen .	
1,763,757	6/1930	Charles .	
2,215,592	9/1940	Nelson .	

2,537,365	1/1951	Montavon	294/49
3,094,348	6/1963	Preziosi .	
3,310,332	3/1967	Nelson .	
3,979,146	9/1976	Berg .	
4,828,690	5/1989	Montez .	
5,069,026	12/1991	Johnson .	
5,417,044	5/1995	Russo .	

OTHER PUBLICATIONS

Little Giant Catalog: p. 6; Metal Dura Fork & Plastic Dura Fork; Miller Manuf. Co., Mar. 1996.

Primary Examiner—Cathy Anne MacCormac
Attorney, Agent, or Firm—Mathews, Collins, Shepherd & Gould, P.A.

[57] **CLAIM**

The ornamental design for a horse mucking rake, as shown and described.

DESCRIPTION

FIG. 1 is a perspective view of a horse mucking rake showing my new design;
FIG. 2 is a front elevational view thereof;
FIG. 3 is a rear elevational view thereof;
FIG. 4 is a right side elevational view thereof;
FIG. 5 is a left side elevational thereof;
FIG. 6 is a top plan view thereof; and,
FIG. 7 is a bottom plan view thereof.

1 Claim, 4 Drawing Sheets

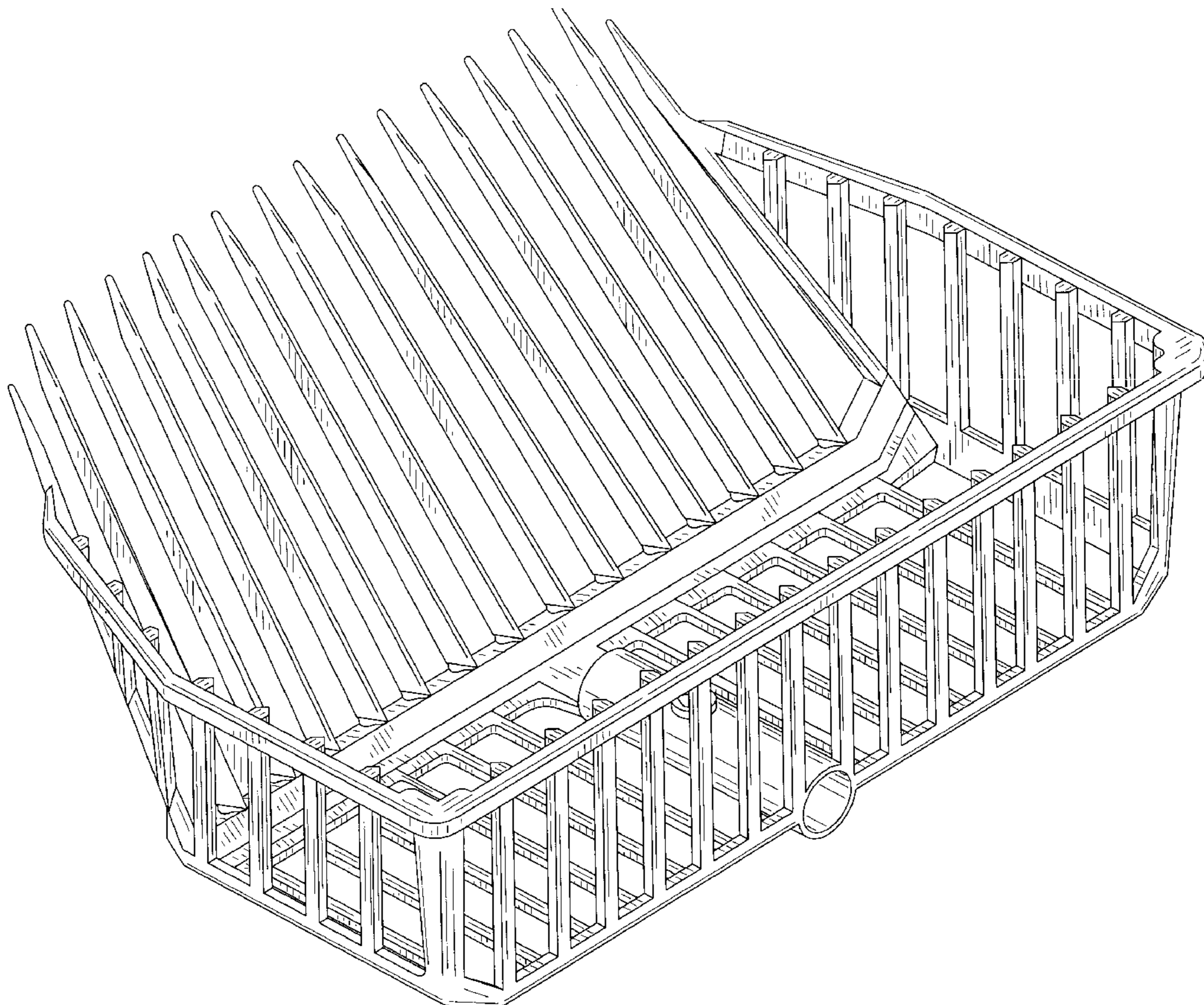

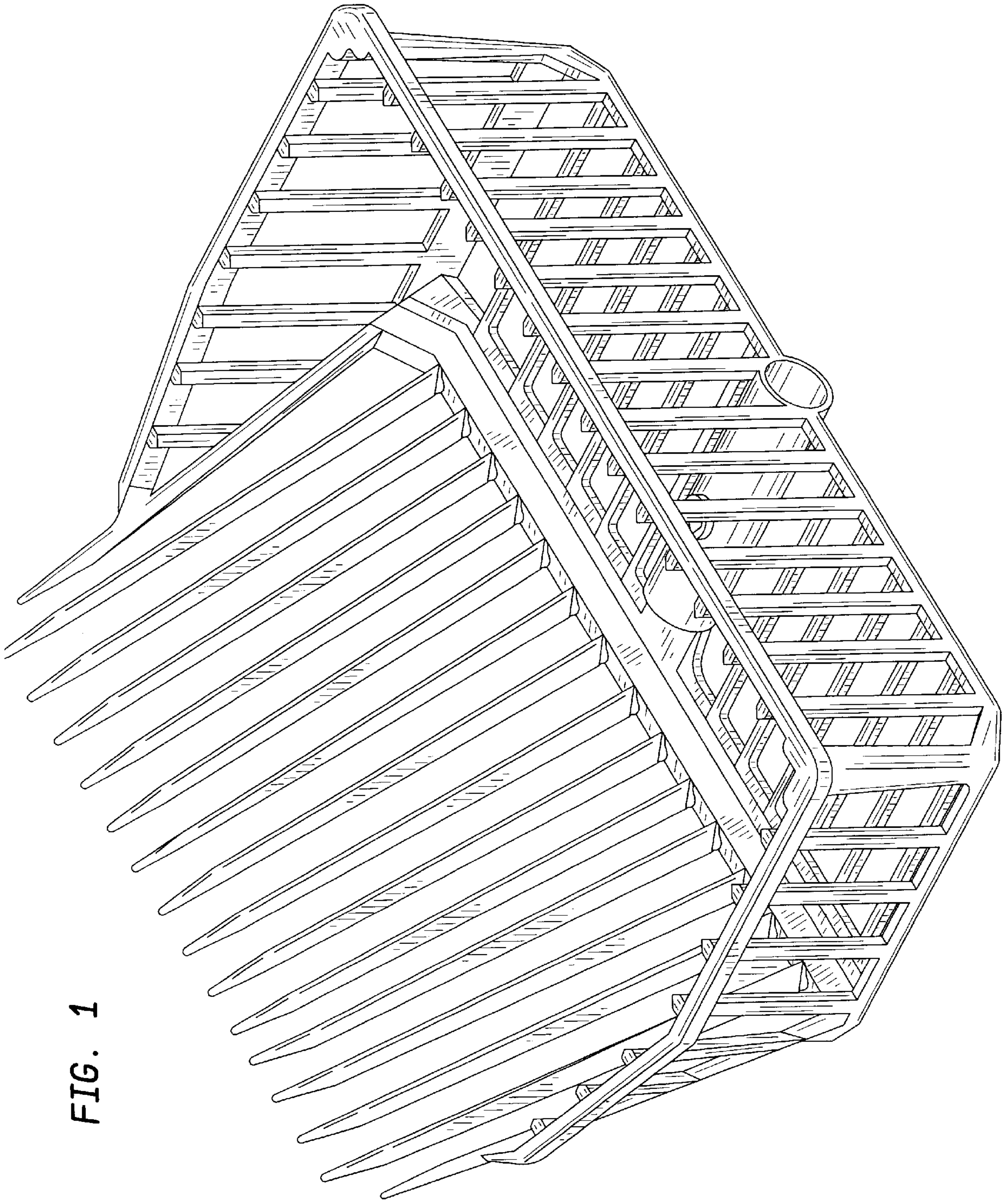

FIG. 1

FIG. 2

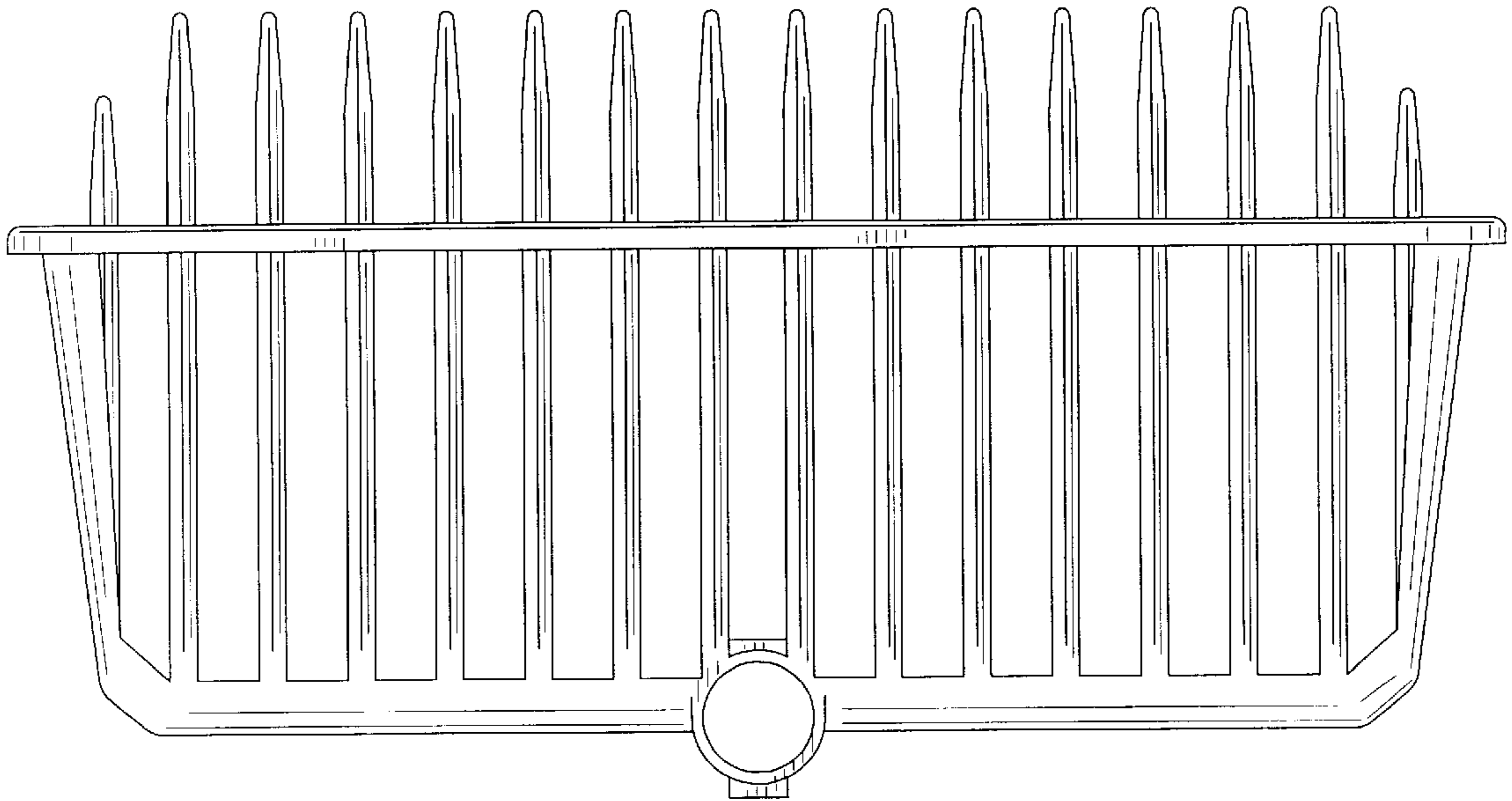

FIG. 3

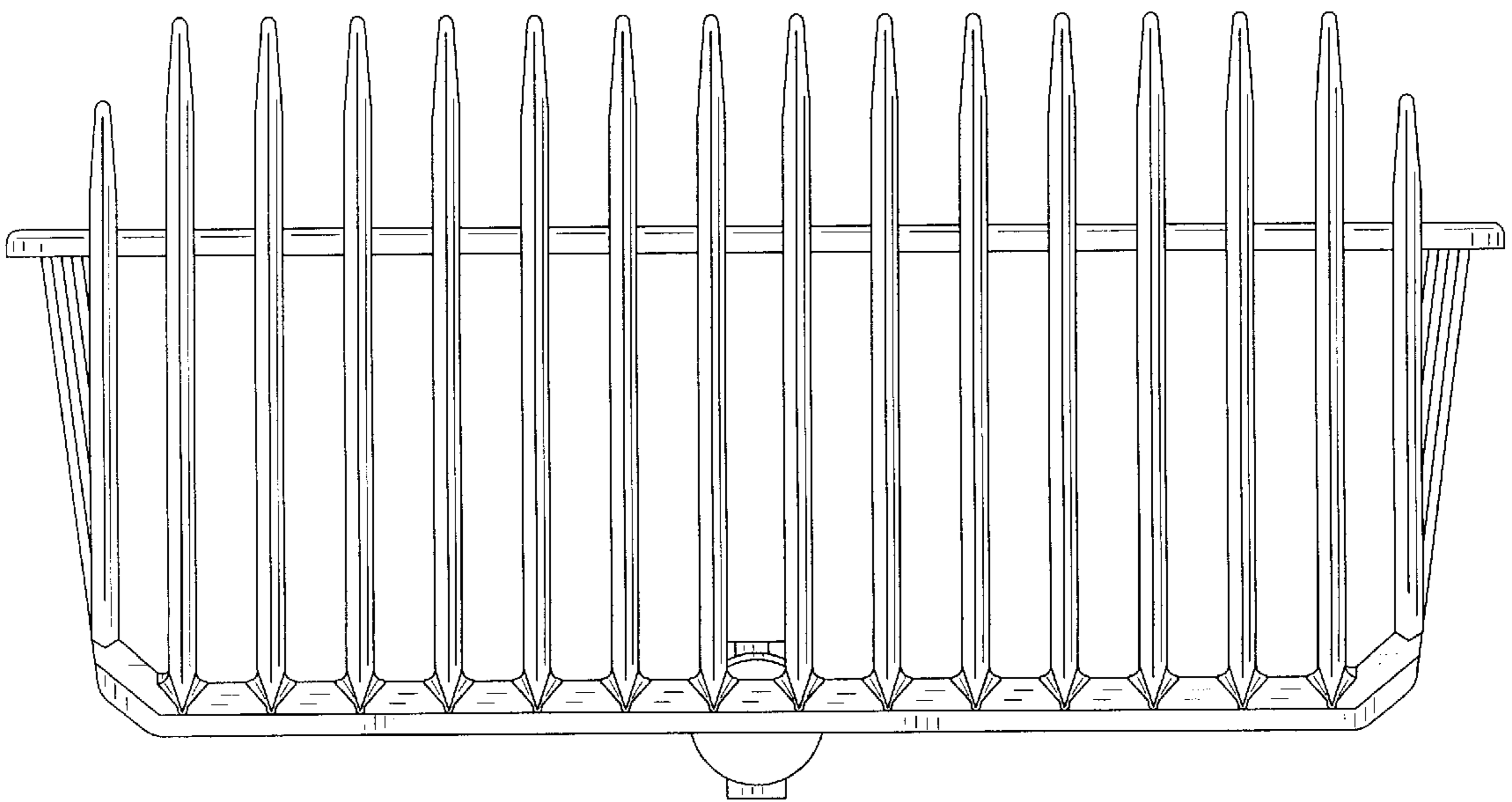

FIG. 4

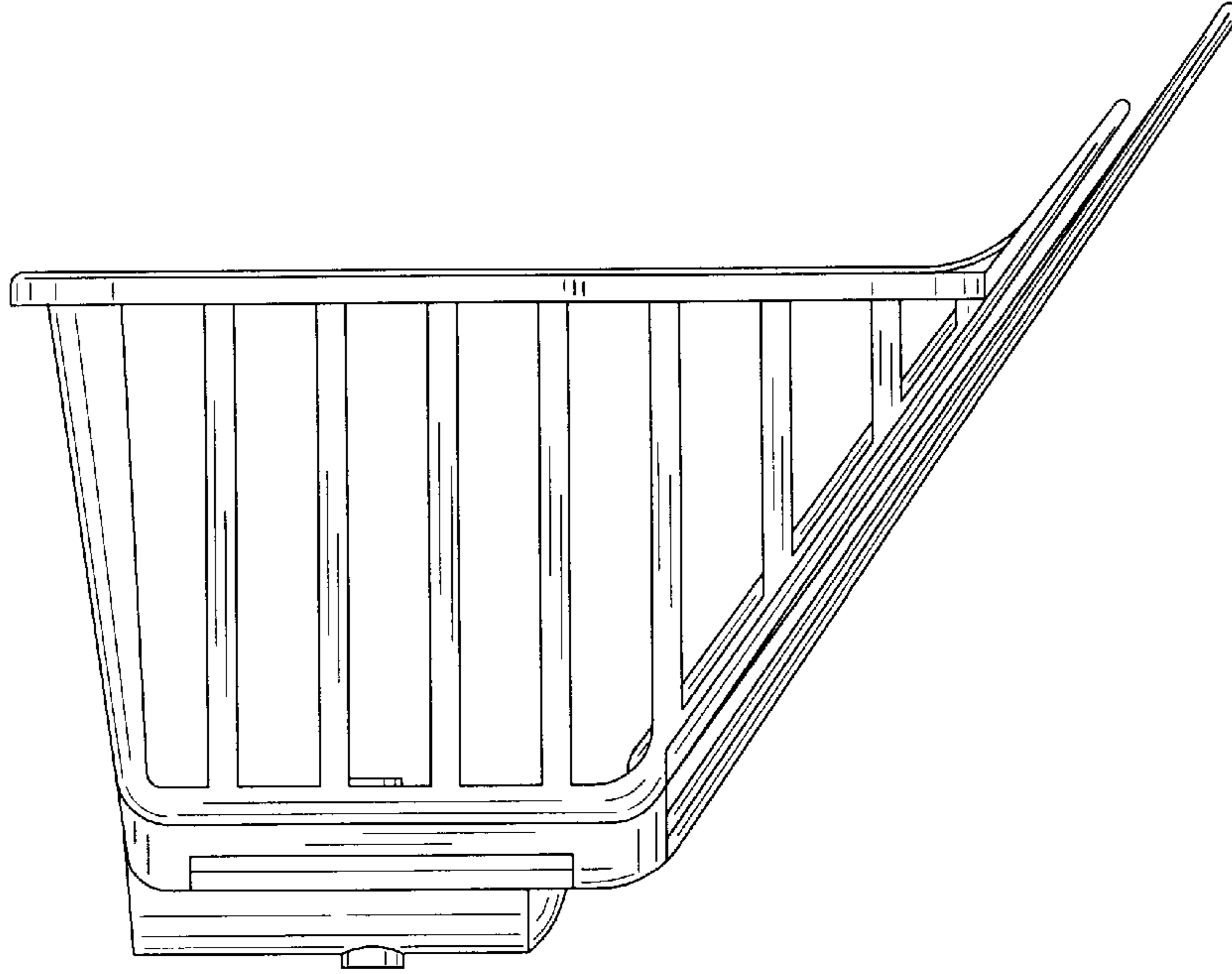

FIG. 5

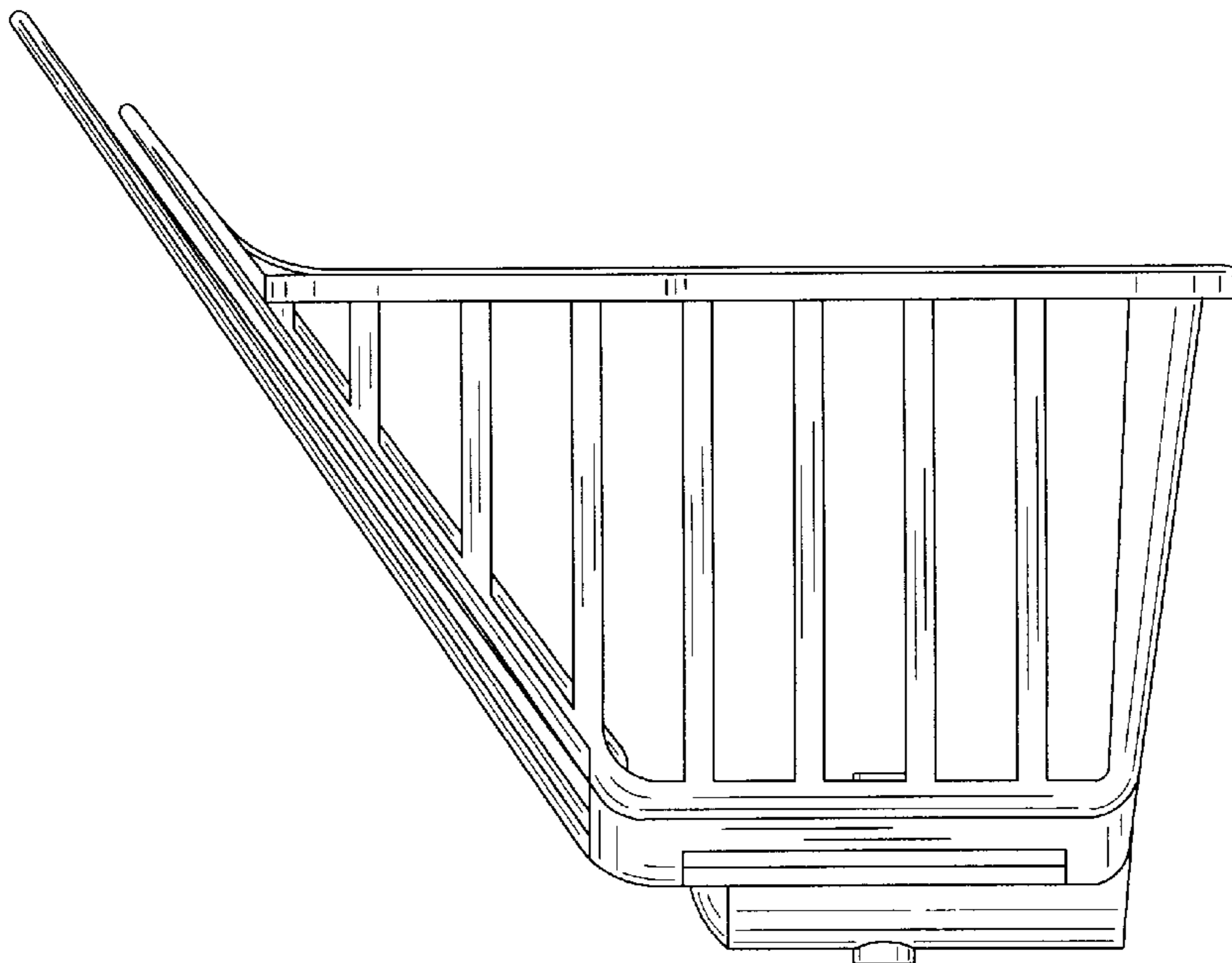

FIG. 6

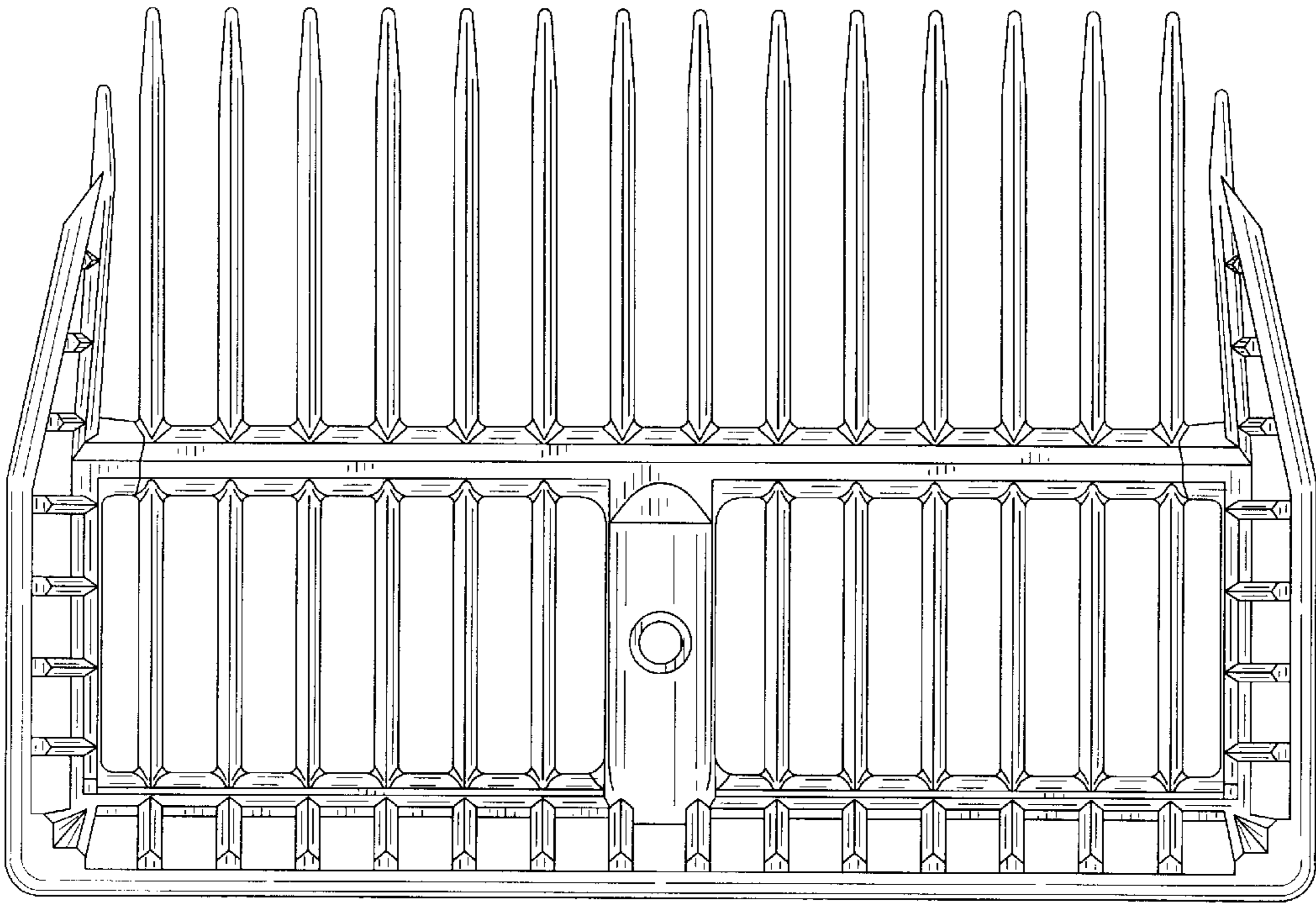

FIG. 7

