



US00D406389S

United States Patent [19]
Henry

[11] **Patent Number: Des. 406,389**
[45] **Date of Patent: **Mar. 2, 1999**

[54] **LOTION DISPENSER**
[76] Inventor: **Murray C. Henry**, P.O. Box 25688,
Portland, Oreg. 97298
[**] Term: **14 Years**
[21] Appl. No.: **72,604**
[22] Filed: **Jun. 20, 1997**
[51] **LOC (6) Cl. 28-02**
[52] **U.S. Cl. D28/7**
[58] **Field of Search D28/7, 9, 63; D4/114,**
D4/116, 120; D24/200, 211, 214; 132/320,
333, 112-118; 401/6, 8, 28, 183, 209, 220,
268-291; 601/94, 113, 131, 154, 155

461118 12/1948 Italy 401/28
503763 2/1956 Italy 601/131
209772 7/1940 Switzerland 401/264
641656 3/1984 Switzerland 401/28

Primary Examiner—Ted Shooman
Assistant Examiner—C. Tuttle
Attorney, Agent, or Firm—Ingrid McTaggart

[57] **CLAIM**

I claim the ornamental design for a lotion dispenser, as shown and described.

DESCRIPTION

FIG. 1 is an isometric view of the lotion dispenser, showing my new design;
FIG. 2 is a top plan view thereof;
FIG. 3 is a front elevational view thereof, the rear elevational view being a mirror image thereof;
FIG. 4 is a left side elevational view thereof, the right side elevational view being a mirror image thereof;
FIG. 5 is a bottom plan view thereof;
FIG. 6 is an isometric view of another embodiment of the lotion dispenser, showing my new design;
FIG. 7 is a top plan view thereof;
FIG. 8 is a front elevational view thereof, the rear elevational view being a mirror image thereof;
FIG. 9 is a left side elevational view thereof, the right side elevational view being a mirror image thereof; and,
FIG. 10 is a bottom plan view thereof.

[56] **References Cited**

U.S. PATENT DOCUMENTS

D. 197,762	3/1964	Lussier et al.	D4/114
D. 262,908	2/1982	Pesco	D24/211
792,276	6/1905	McCarthy	401/205
1,604,435	10/1926	Wharton	601/154
2,930,060	3/1960	Pearce	401/184
2,988,084	6/1961	Douglas	601/80
4,037,977	7/1977	Ronai	401/209
5,125,757	6/1992	Morrison et al.	401/21
5,131,384	7/1992	Obagi	601/137

FOREIGN PATENT DOCUMENTS

1176734	4/1959	France	601/134
---------	--------	--------------	---------

1 Claim, 2 Drawing Sheets

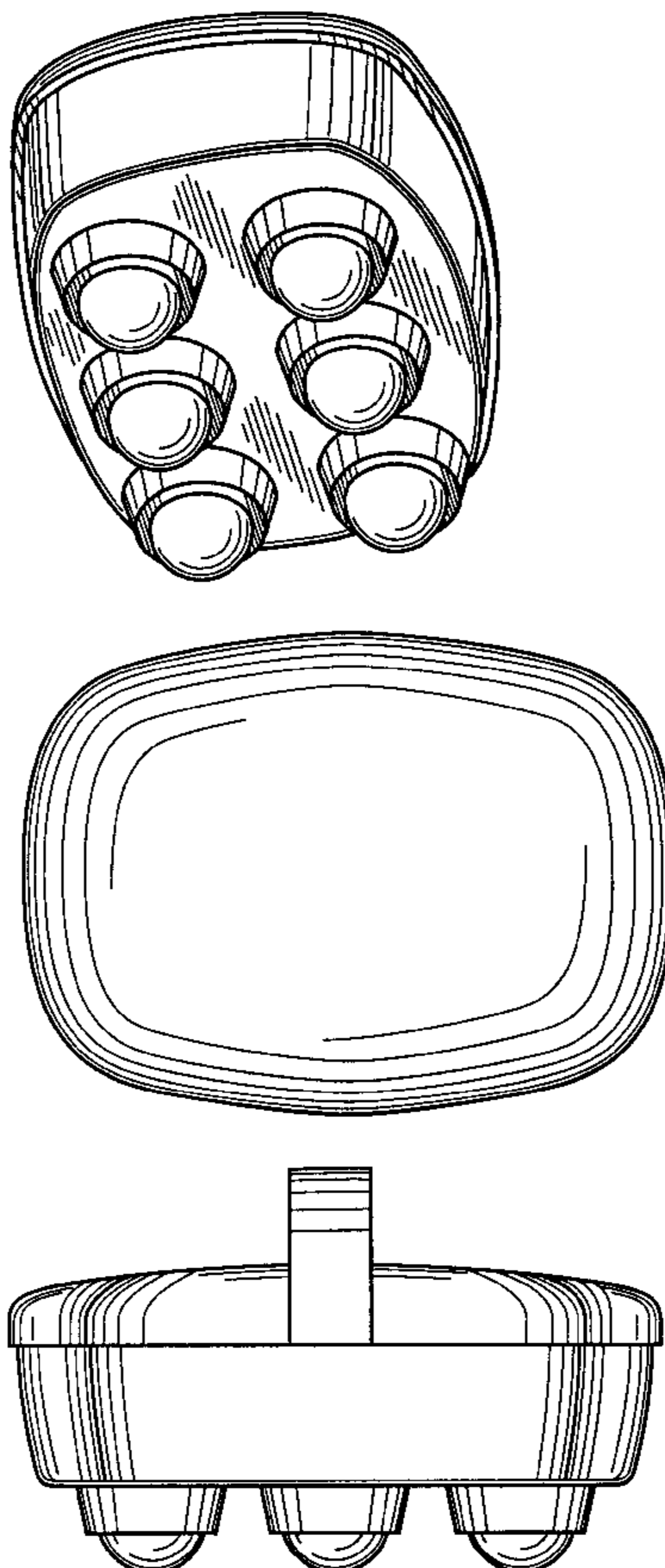

FIG. 1

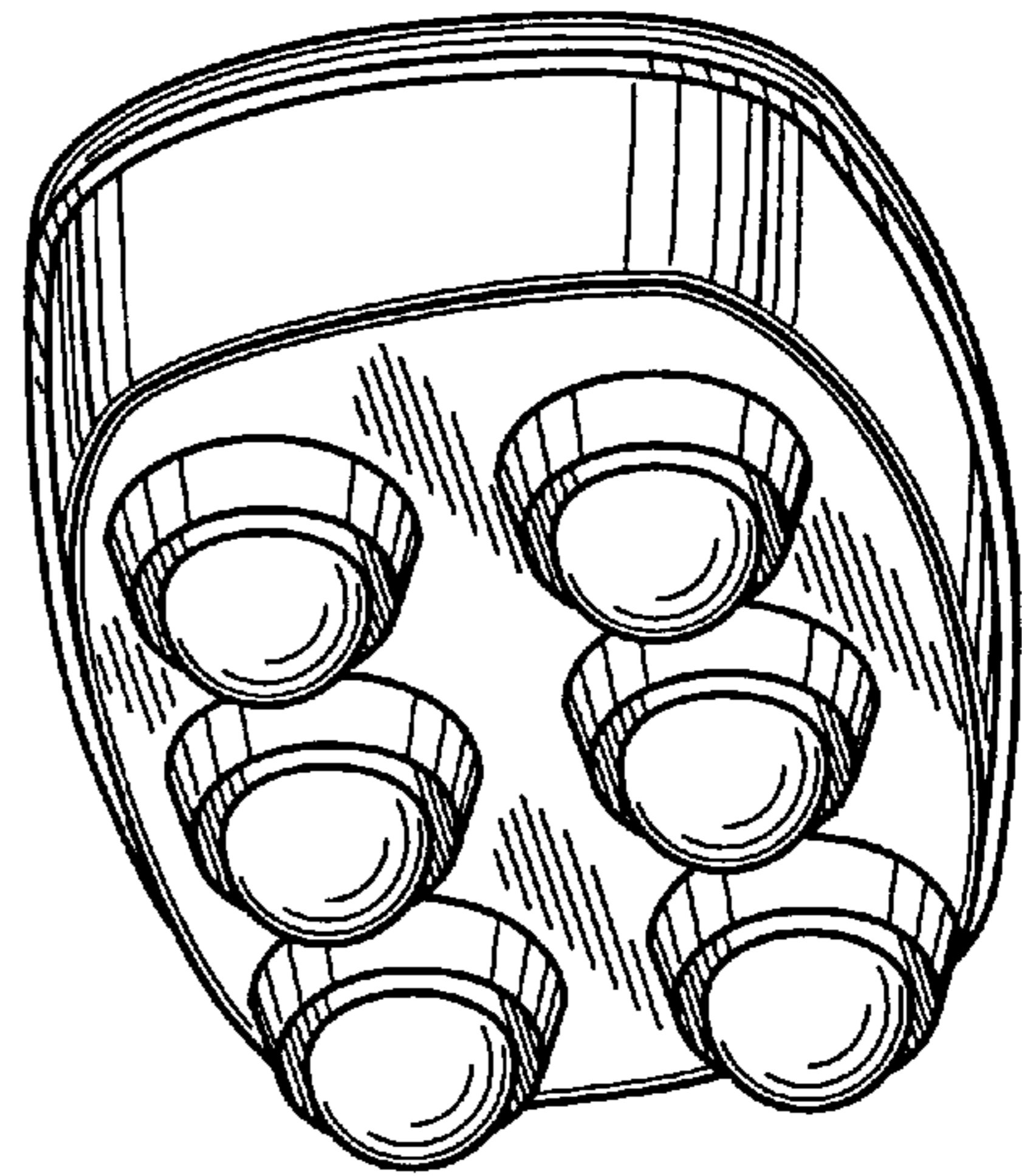

FIG. 2

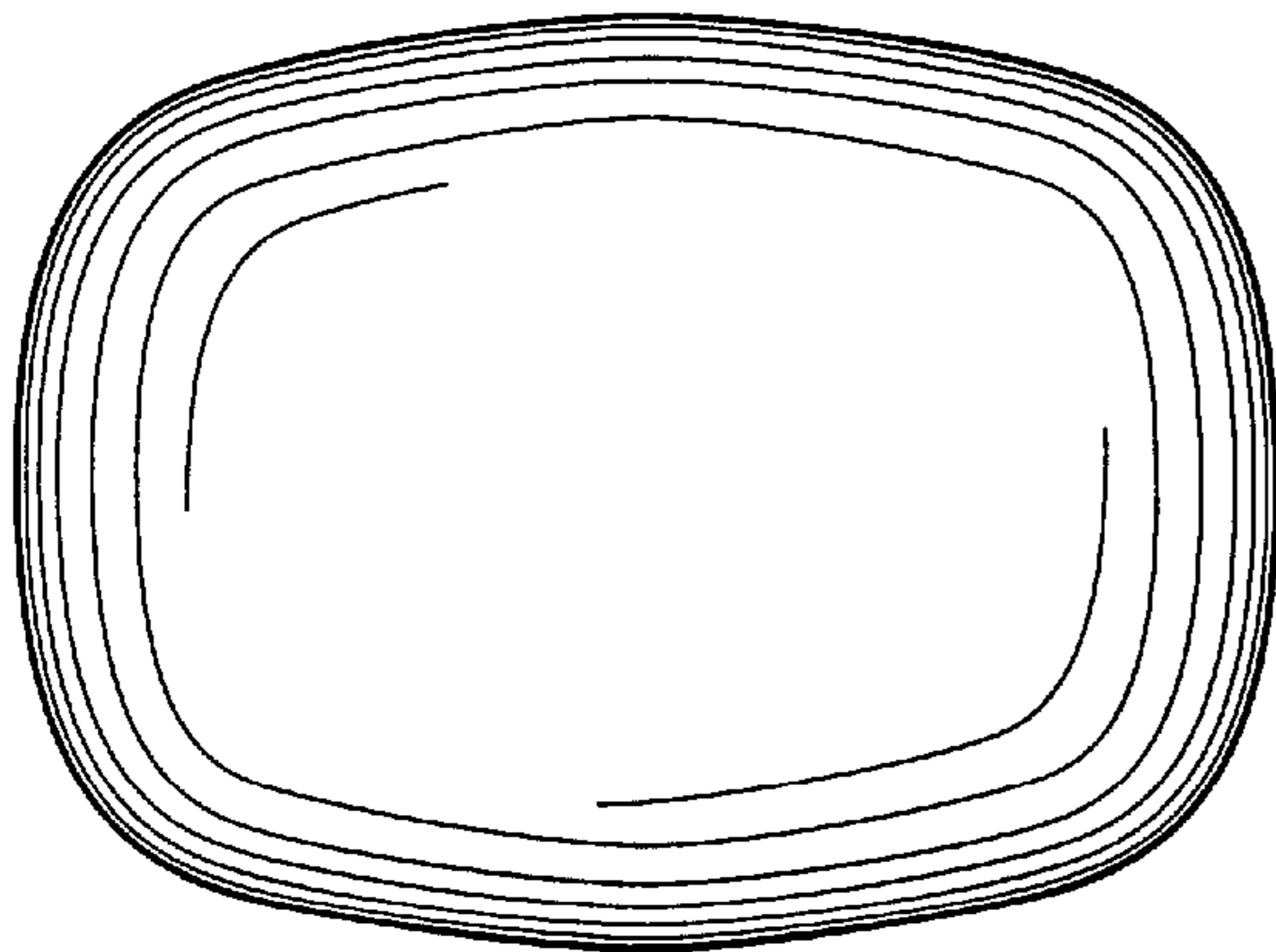

FIG. 3

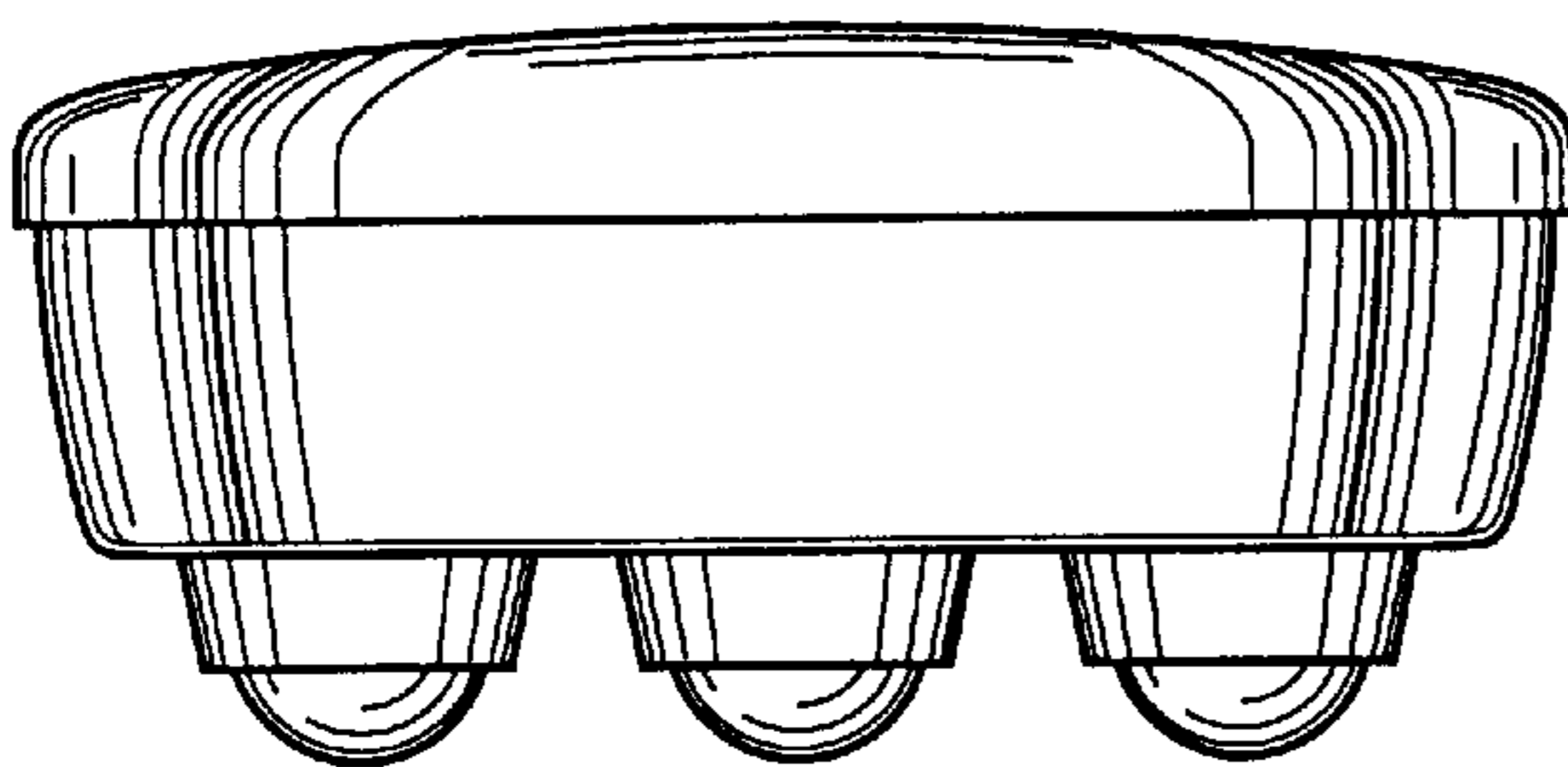

FIG. 4

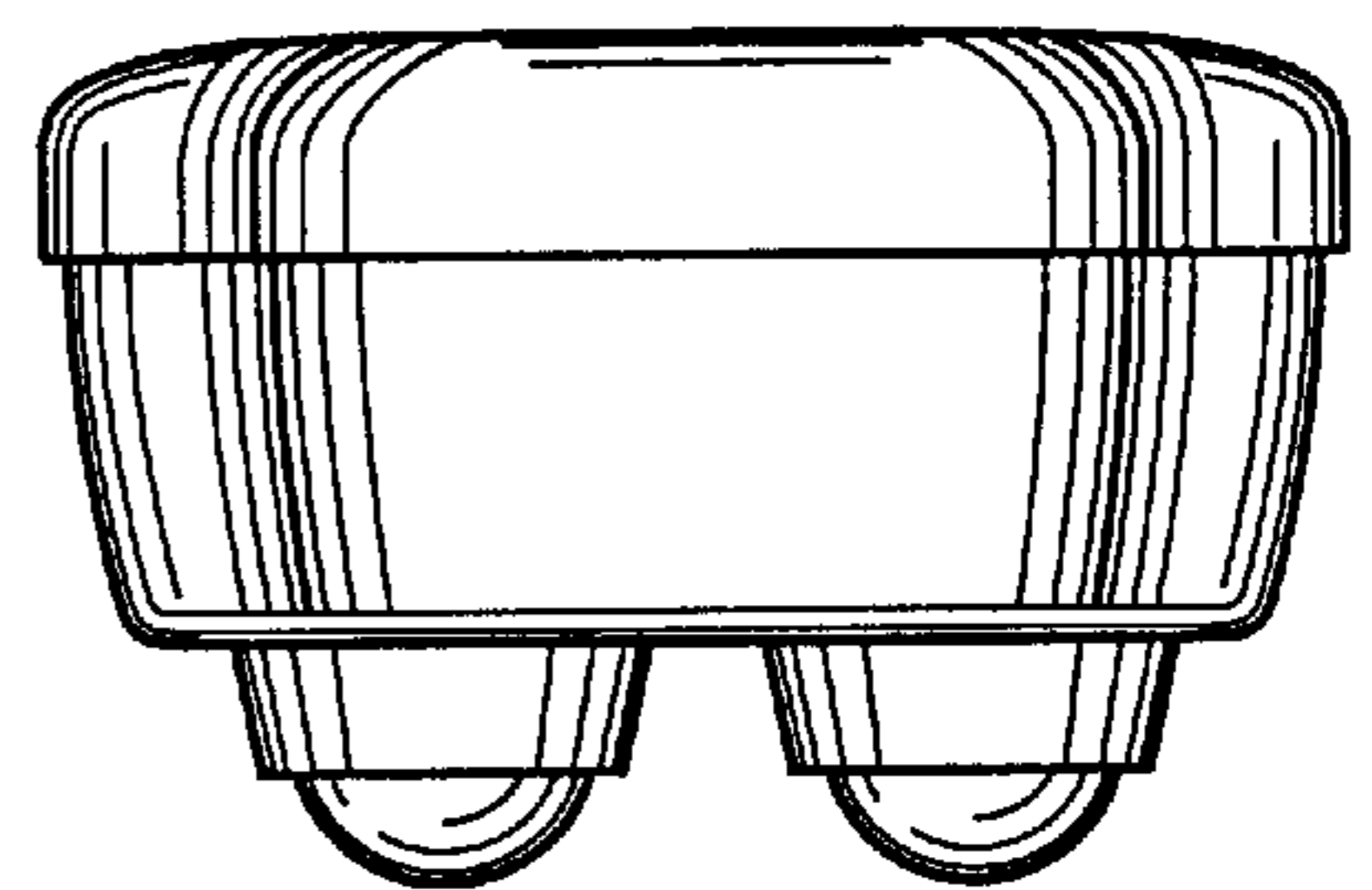

FIG. 5

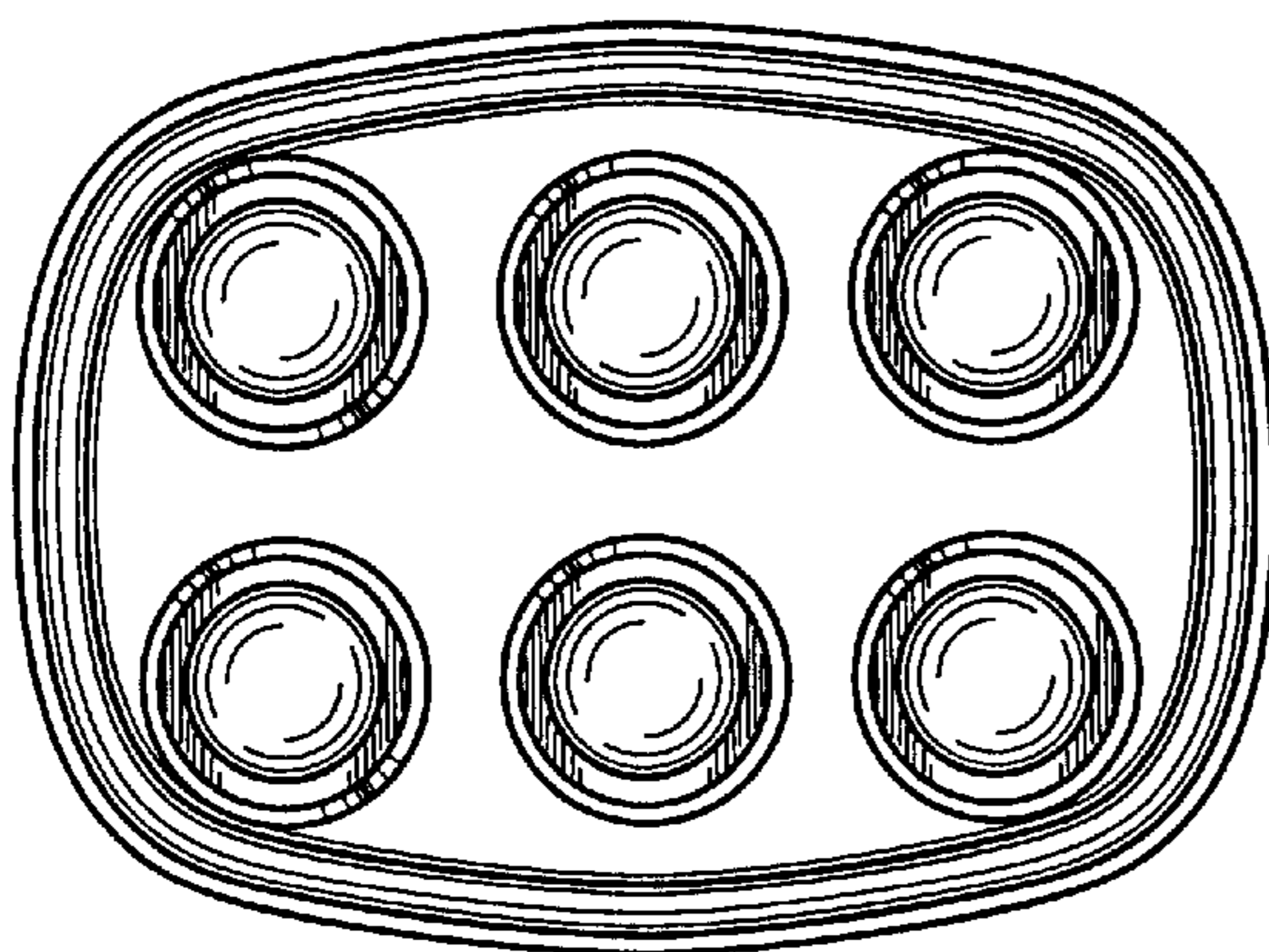

FIG. 6

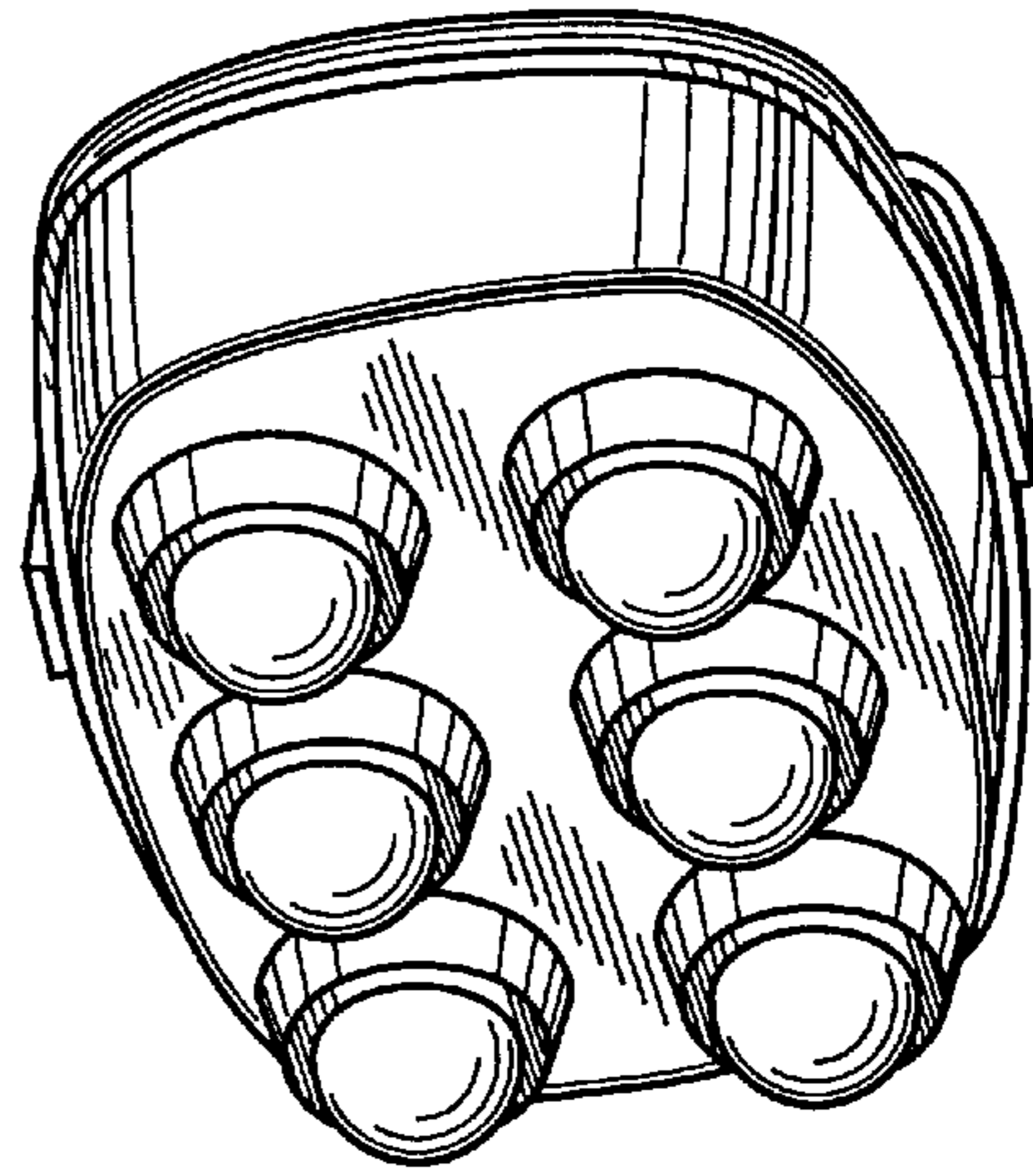

FIG. 7

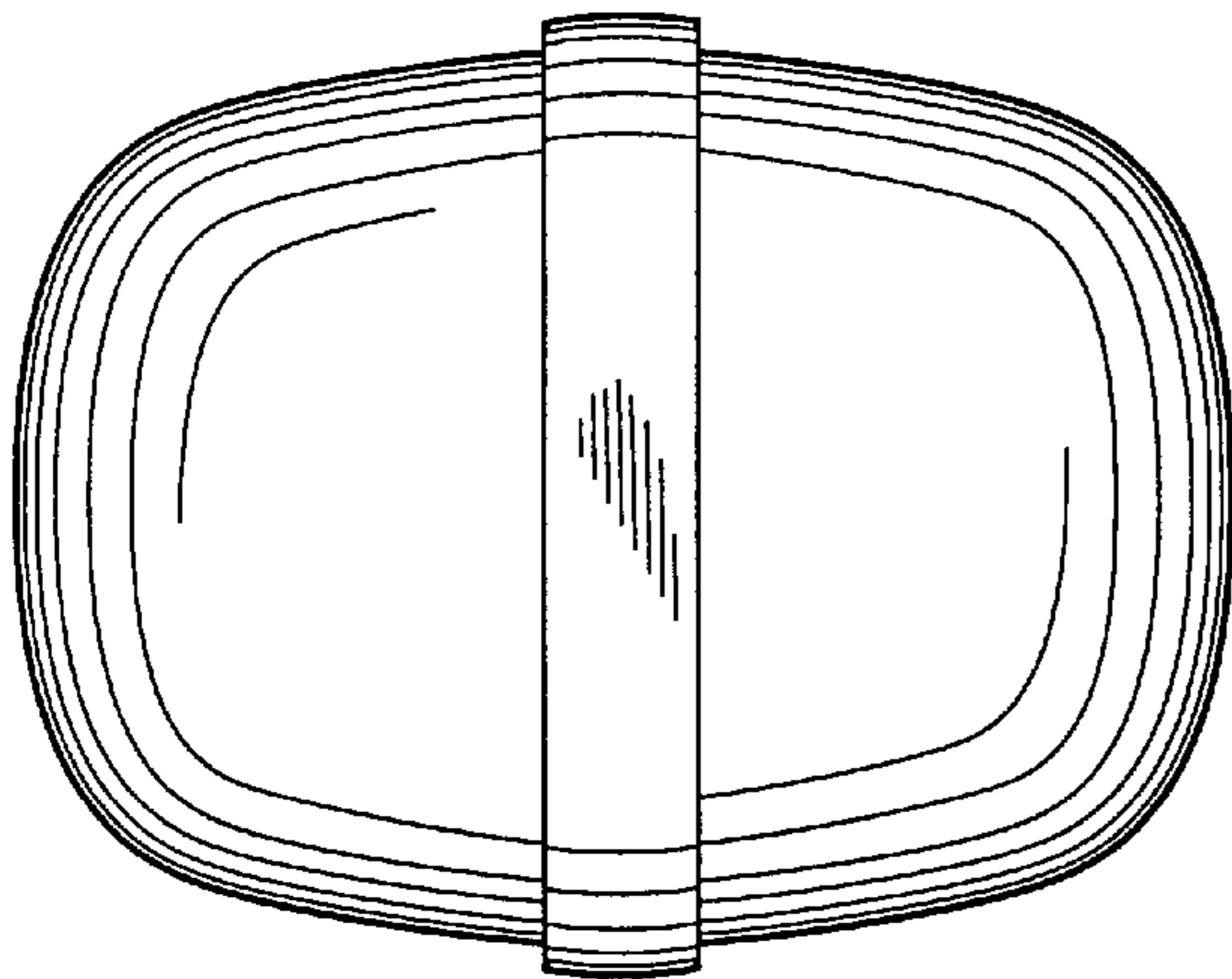

FIG. 9

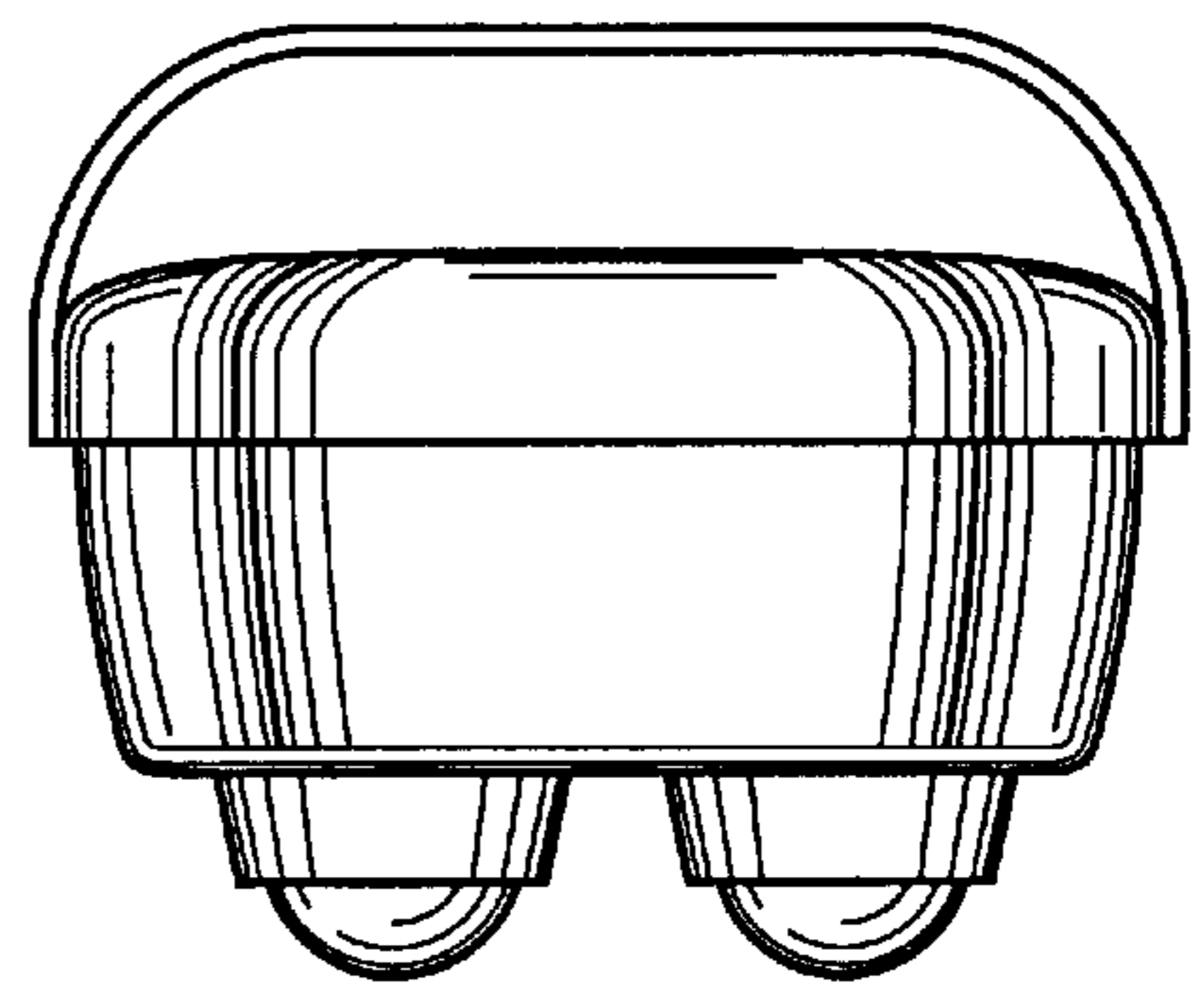

FIG. 8

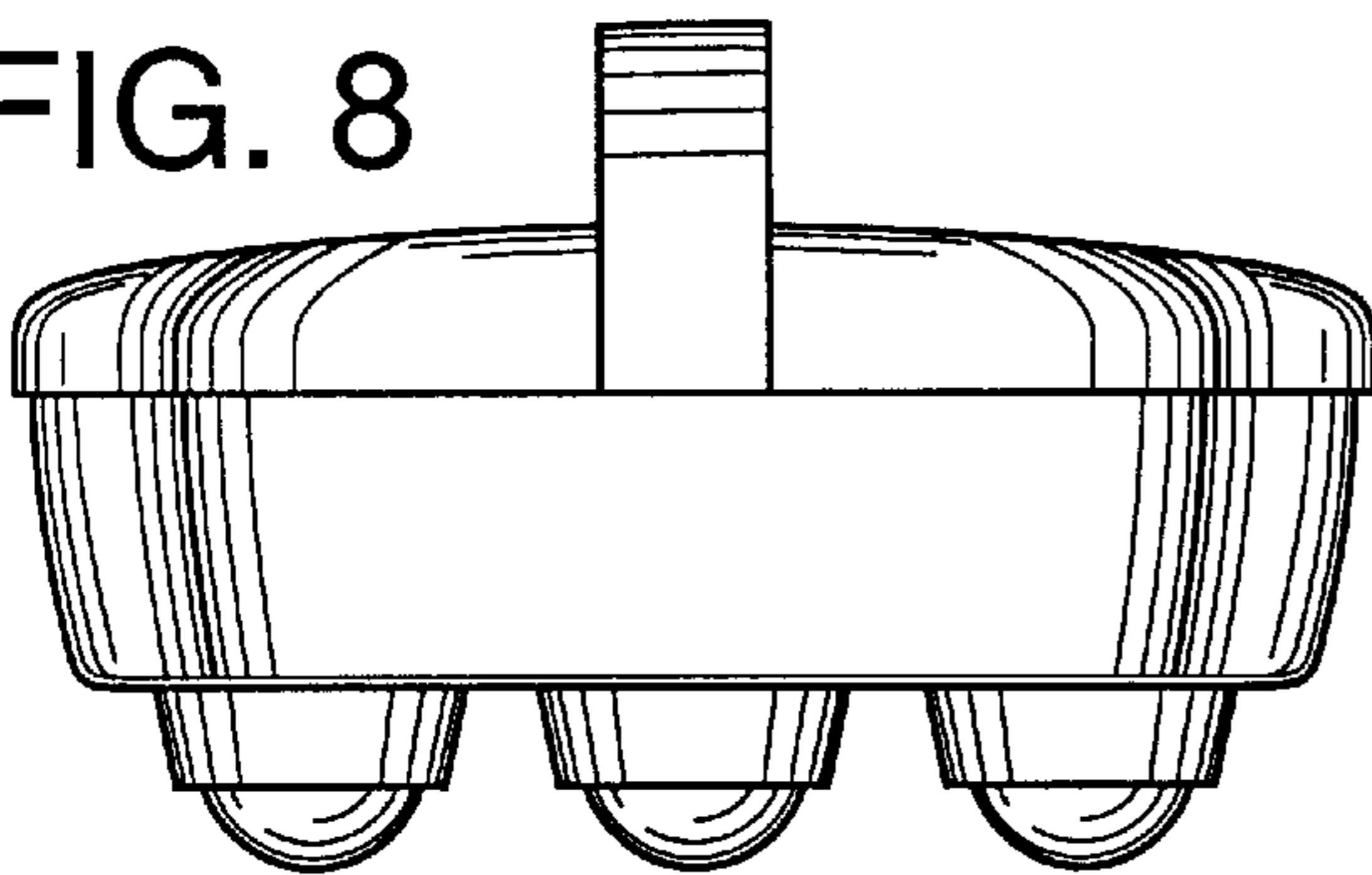

FIG. 10

