



US00D406378S

United States Patent [19]

Walters et al.

[11] **Patent Number:** **Des. 406,378**

[45] **Date of Patent:** ****Mar. 2, 1999**

[54] **SPORTS TROPHY LAMP**

[76] Inventors: **James L Walters**, 9189 Panama Ct., Ypsilanti, Mich. 48198; **Timmie Williams**, 6711 Church St., #10-D, Riverdale, Ga. 30274

[**] Term: **14 Years**

[21] Appl. No.: **86,548**

[22] Filed: **Apr. 15, 1998**

[51] **LOC (6) Cl.** **26-05**

[52] **U.S. Cl.** **D26/94; D11/157**

[58] **Field of Search** **D26/93, 102-112, D26/94, 73; D11/131, 157; 362/410-414, 806**

[56] **References Cited**

U.S. PATENT DOCUMENTS

- D. 212,441 10/1968 Espinosa D26/73
- D. 390,649 2/1998 Pearce et al. D26/73 X

Primary Examiner—Susan J. Lucas

[57] **CLAIM**

The ornamental design for a sports trophy lamp, as shown.

DESCRIPTION

FIG. 1 is a front elevational view of the sports trophy lamp of the present invention;

FIG. 2 is a back elevational view of the sports trophy lamp of FIG. 1;

FIG. 3 is a left side elevational view of the sports trophy lamp of FIG. 1;

FIG. 4 is a right side elevational view of the sports trophy lamp of FIG. 1;

FIG. 5 is a top plan view of the sports trophy lamp of FIG. 1; and,

FIG. 6 is a bottom plan view of the sports trophy lamp of FIG. 1.

The broken lines are shown for illustrative purposes only and form no part of the claimed design.

1 Claim, 3 Drawing Sheets

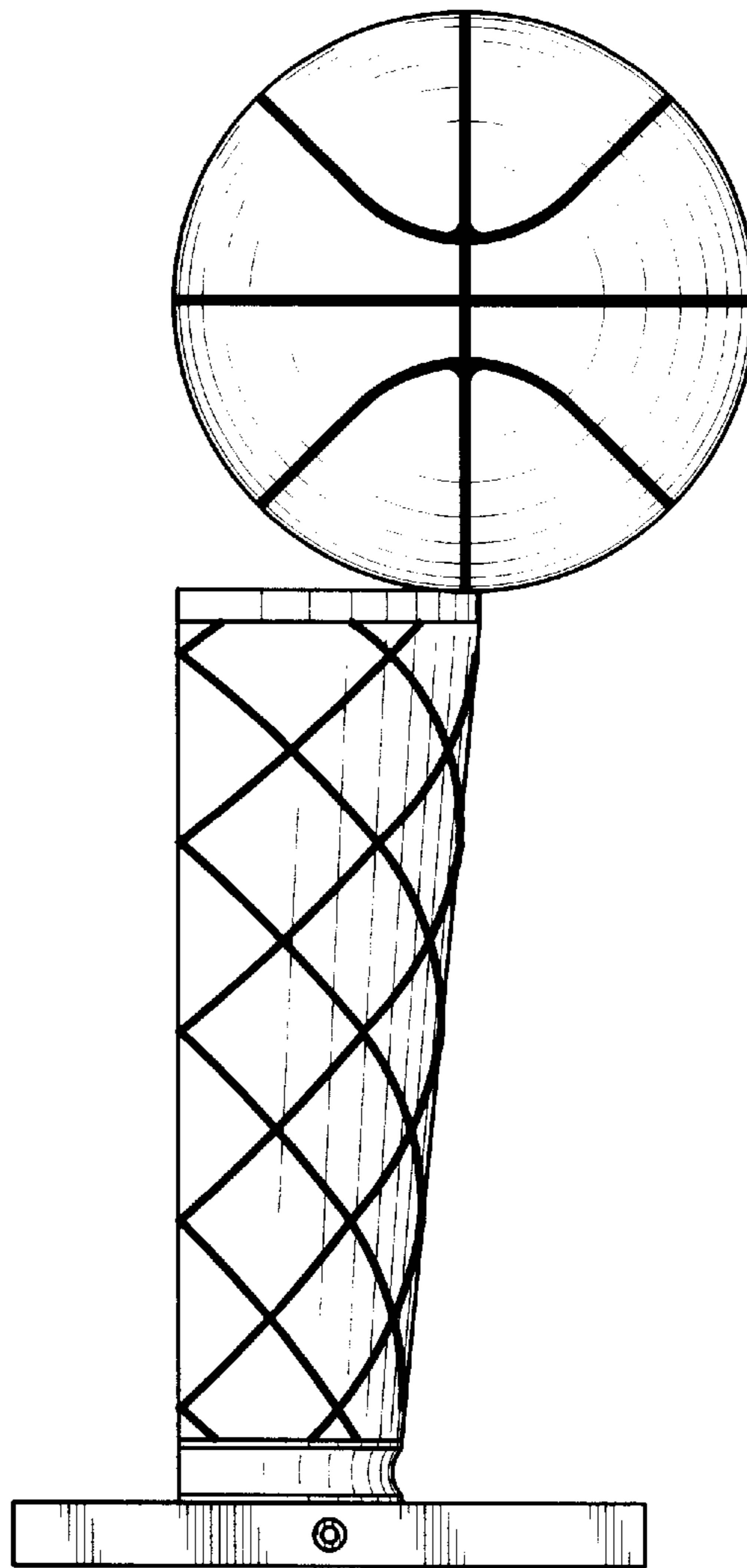
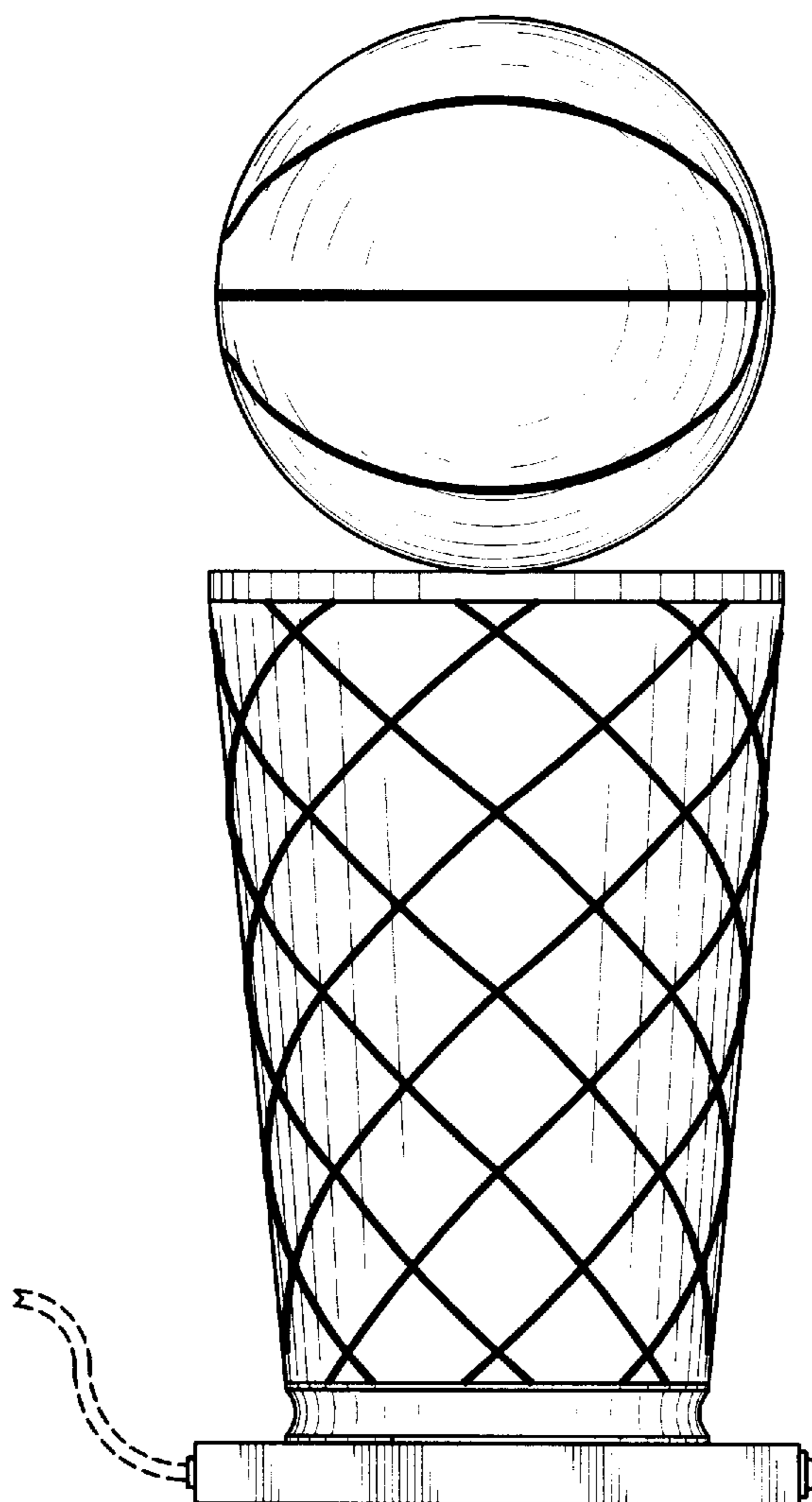

FIG. 1

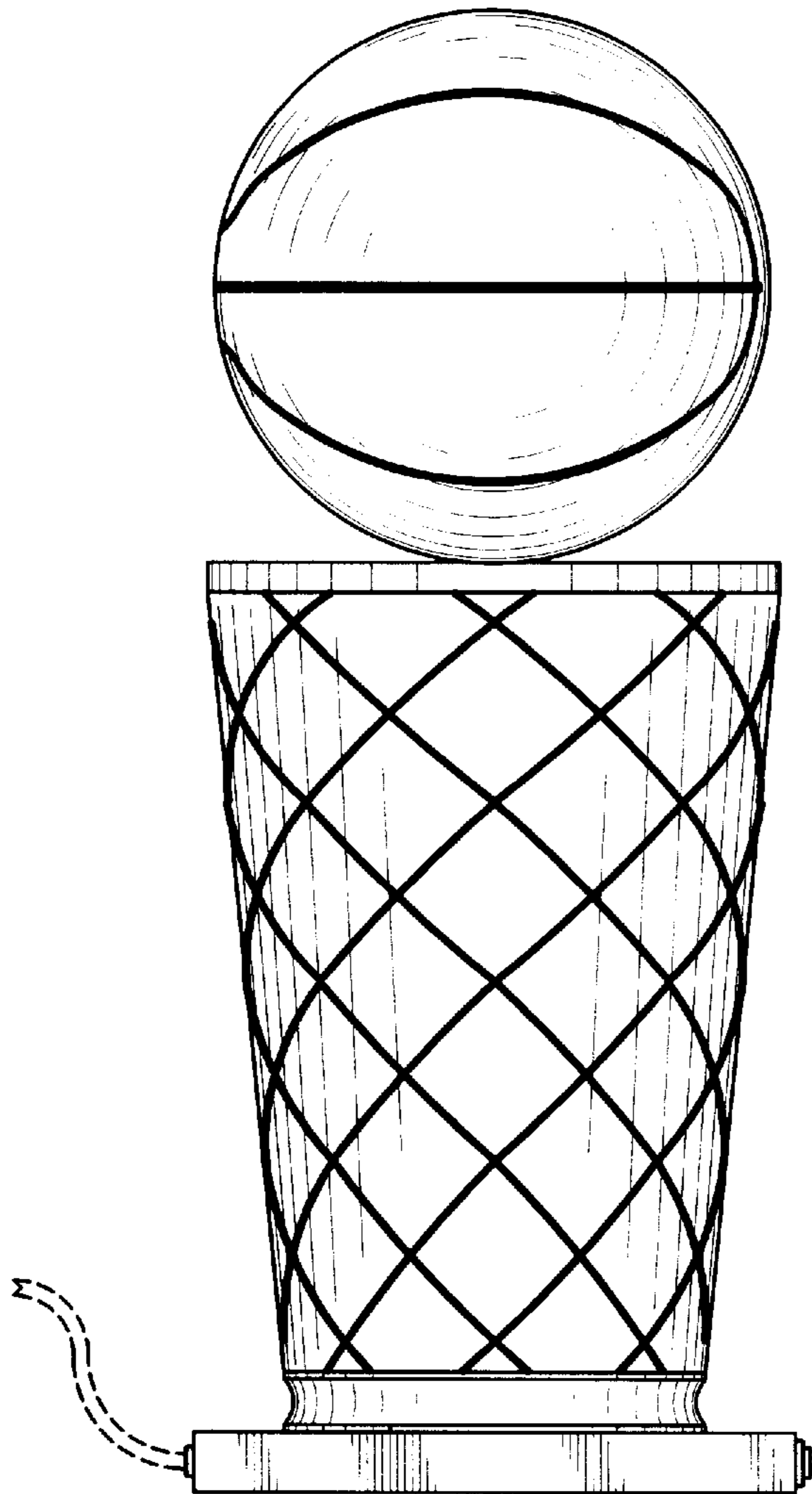

FIG. 2

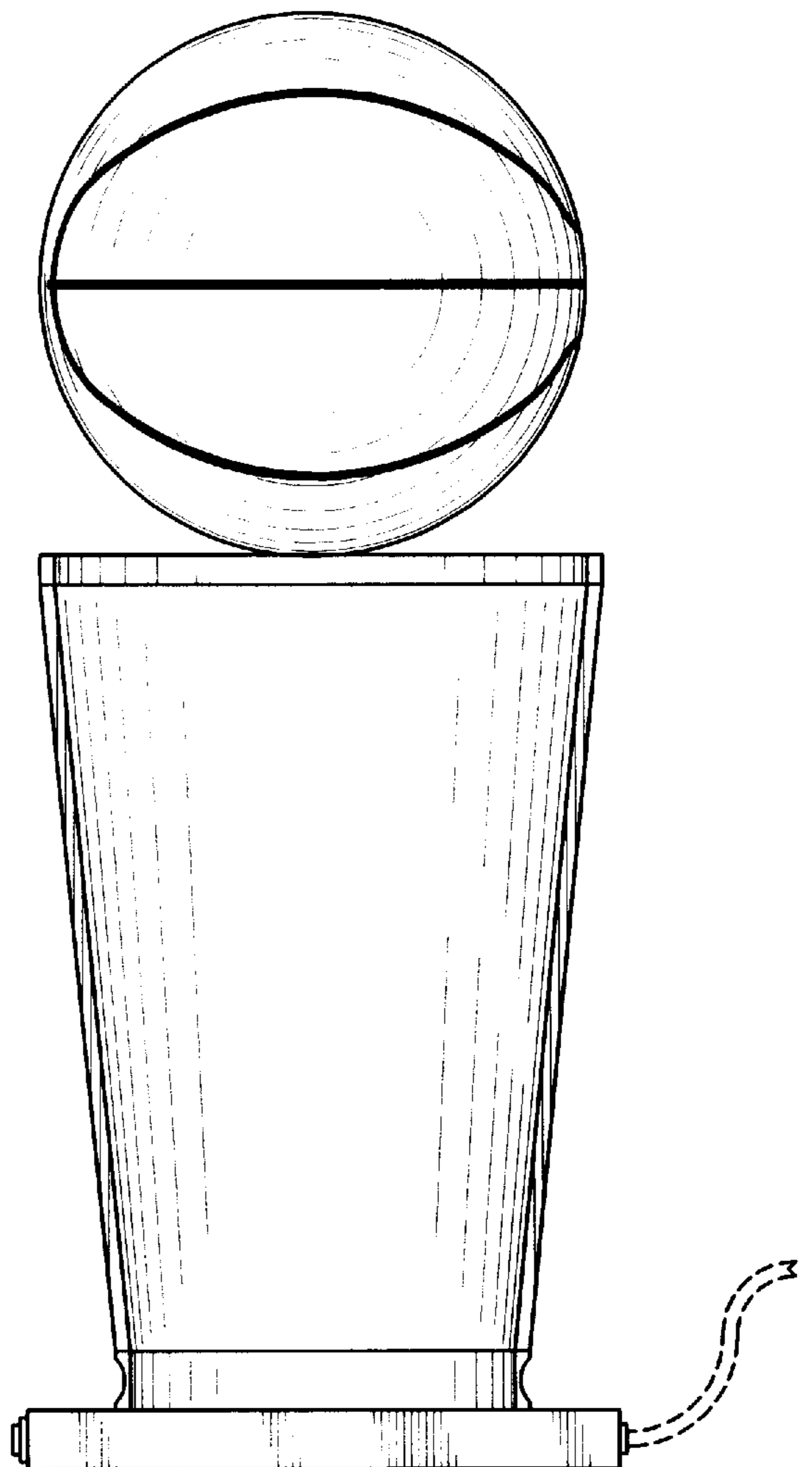

FIG. 3

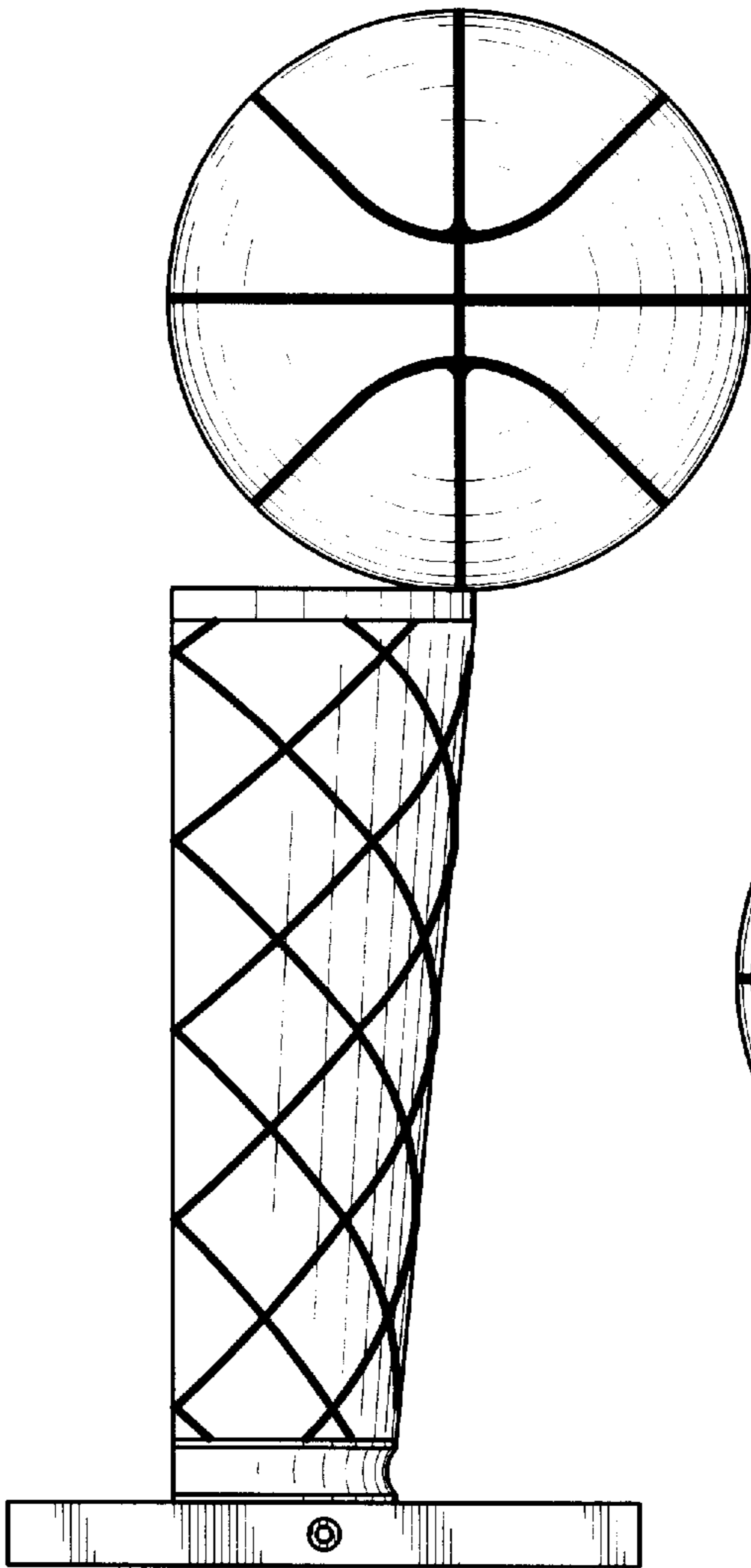

FIG. 4

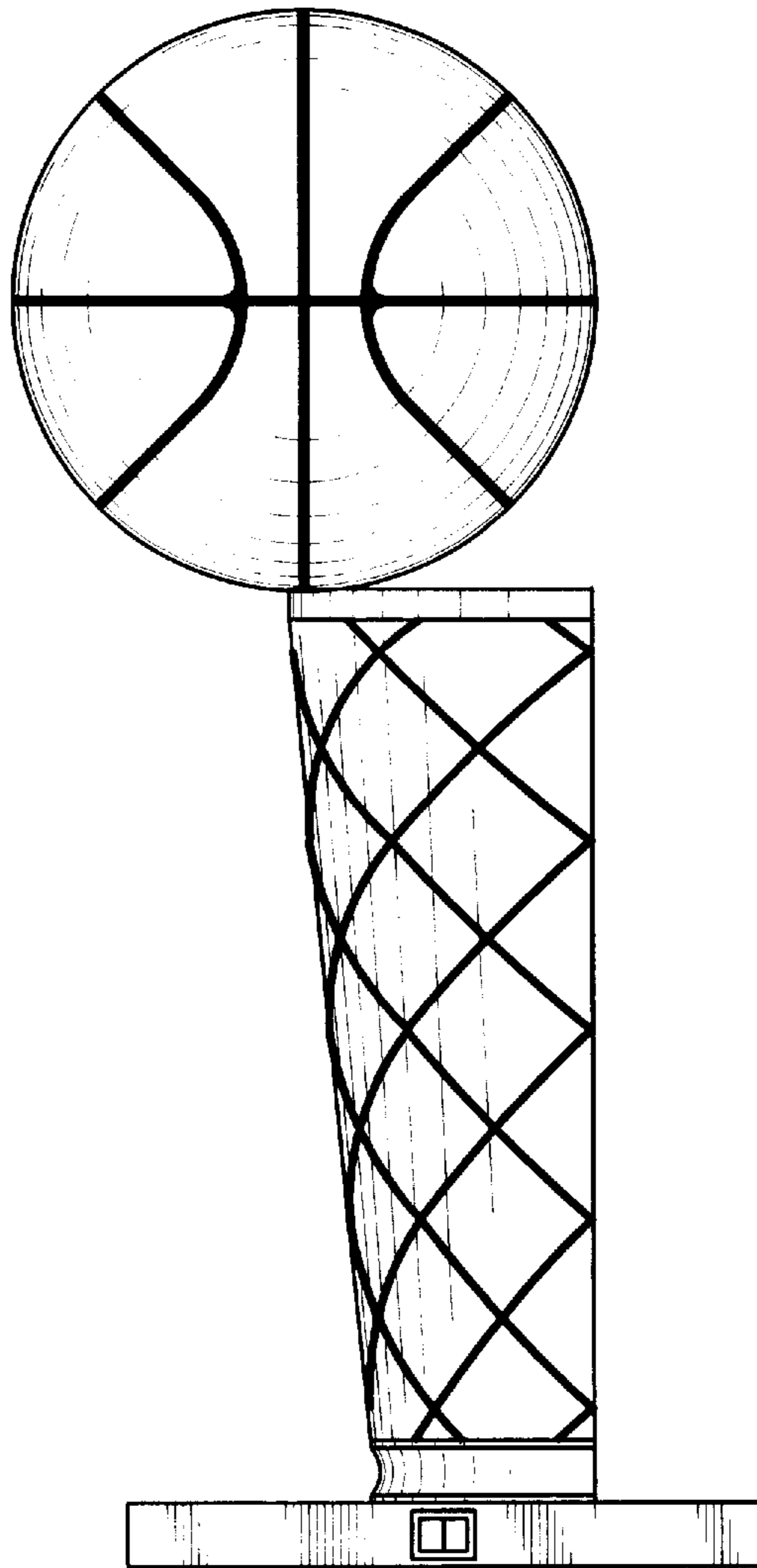

FIG. 5

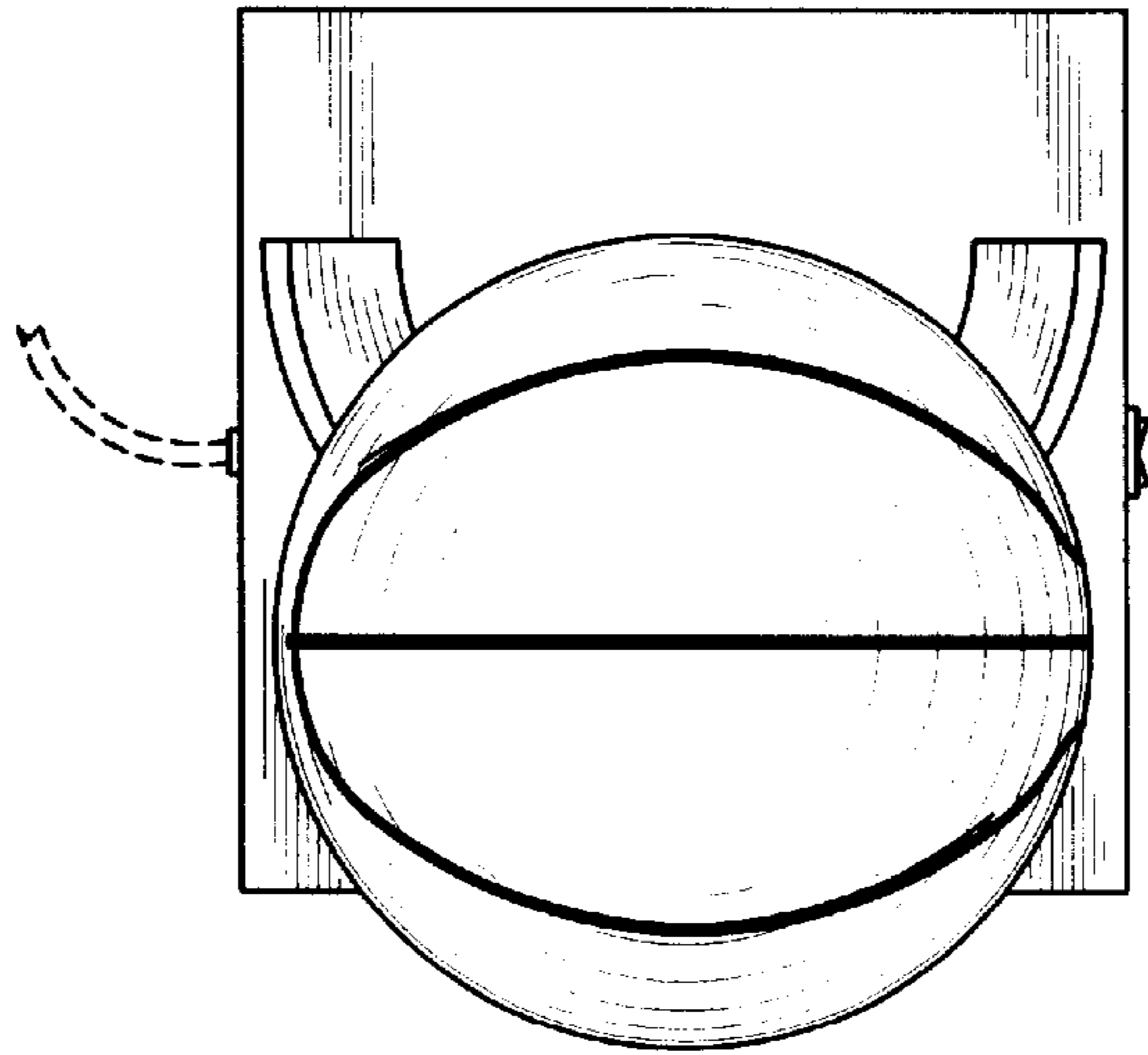

FIG. 6

