



US00D406372S

# United States Patent [19]

Matthes et al.

[11] Patent Number: Des. 406,372

[45] Date of Patent: \*\*Mar. 2, 1999

[54] PIVOT HEAD FLASHLIGHT

[75] Inventors: **Robert W. Matthes; Richard K. Pallo**, both of Buckingham, Pa.; **Scott D. Price**, Pylesville; **Roger Q. Smith**, Reisterstown, both of Md.; **Velissa Van Scoyoc**, Pottstown, Pa.

[73] Assignee: **Black & Decker Inc.**, Newark, Del.

[\*\*] Term: **14 Years**

[21] Appl. No.: **58,205**

[22] Filed: **Aug. 9, 1996**

[51] LOC (6) Cl. .... **26-02**

[52] U.S. Cl. .... **D26/44**

[58] Field of Search ..... D26/37-50; 362/157, 362/158, 171, 172, 178, 181, 183, 192, 194, 196, 197, 200-206

[56] **References Cited**

**U.S. PATENT DOCUMENTS**

- D. 128,638 8/1941 Muldoon .
- D. 139,550 11/1944 Kinney, Jr. .
- D. 142,277 8/1945 Lippincott .
- D. 144,946 6/1946 Stegman .
- D. 153,282 4/1949 Haas .
- D. 199,264 9/1964 Doring .
- D. 216,735 3/1970 Brindley .
- D. 230,068 1/1974 Numbers .
- D. 263,170 2/1982 Maglica .
- D. 276,375 11/1984 Fenne .
- D. 285,356 8/1986 Schosser et al. .
- D. 287,642 1/1987 Kung .
- D. 290,517 6/1987 Smith .
- D. 295,561 5/1988 Hsiao .
- D. 303,846 10/1989 Parker .
- D. 307,488 4/1990 Sharrah .
- D. 308,253 5/1990 Battles et al. .
- D. 308,254 5/1990 Ohashi .
- D. 308,257 5/1990 Staubitz et al. .
- D. 309,952 8/1990 Lee .
- D. 322,141 12/1991 Yuen .
- D. 323,404 1/1992 Fenne .
- D. 332,319 1/1993 Yuen .

- D. 332,321 1/1993 Yuen .
- D. 333,358 2/1993 Burns .
- D. 333,527 2/1993 Leung .
- D. 348,740 7/1994 Yuen .
- D. 351,477 10/1994 Bamber .
- D. 355,040 1/1995 Dalton et al. .
- D. 360,043 7/1995 Inukai .
- D. 360,045 7/1995 Inukai .
- D. 360,702 7/1995 Bamber .
- D. 362,319 9/1995 Bamber .
- D. 363,138 10/1995 Poon .
- D. 368,147 3/1996 Bamber et al. .
- D. 384,760 10/1997 Schultz ..... D26/48
- D. 391,654 3/1998 Matthes et al. .... D26/37
- 2,510,812 6/1950 Garland et al. .
- 2,934,635 4/1960 Cheng .
- 5,432,689 7/1995 Sharrah et al. .
- 5,605,394 2/1997 Chen .

**FOREIGN PATENT DOCUMENTS**

- M010253 2/1988 Germany .
- M9102122 11/1991 Germany .
- M9104906 2/1992 Germany .
- M9206121 6/1993 Germany .
- M9504099 1/1996 Germany .

*Primary Examiner*—Marcus A. Jackson  
*Attorney, Agent, or Firm*—Bruce S. Shapiro; Dennis A. Dearing; John D. Del Ponti

[57] **CLAIM**

The ornamental design for a pivot head flashlight, as shown and described.

**DESCRIPTION**

FIG. 1 is a perspective view of a pivot head flashlight showing our new design; FIG. 2 is a top plan view thereof; FIG. 3 is a bottom plan view thereof; FIG. 4 is a left side elevational view thereof; FIG. 5 is a right side elevational view thereof; FIG. 6 is a front elevational view thereof; FIG. 7 is a rear elevational view thereof; and, FIG. 8 is a left side view of a second embodiment in which the head is pivoted 90°.

**1 Claim, 5 Drawing Sheets**

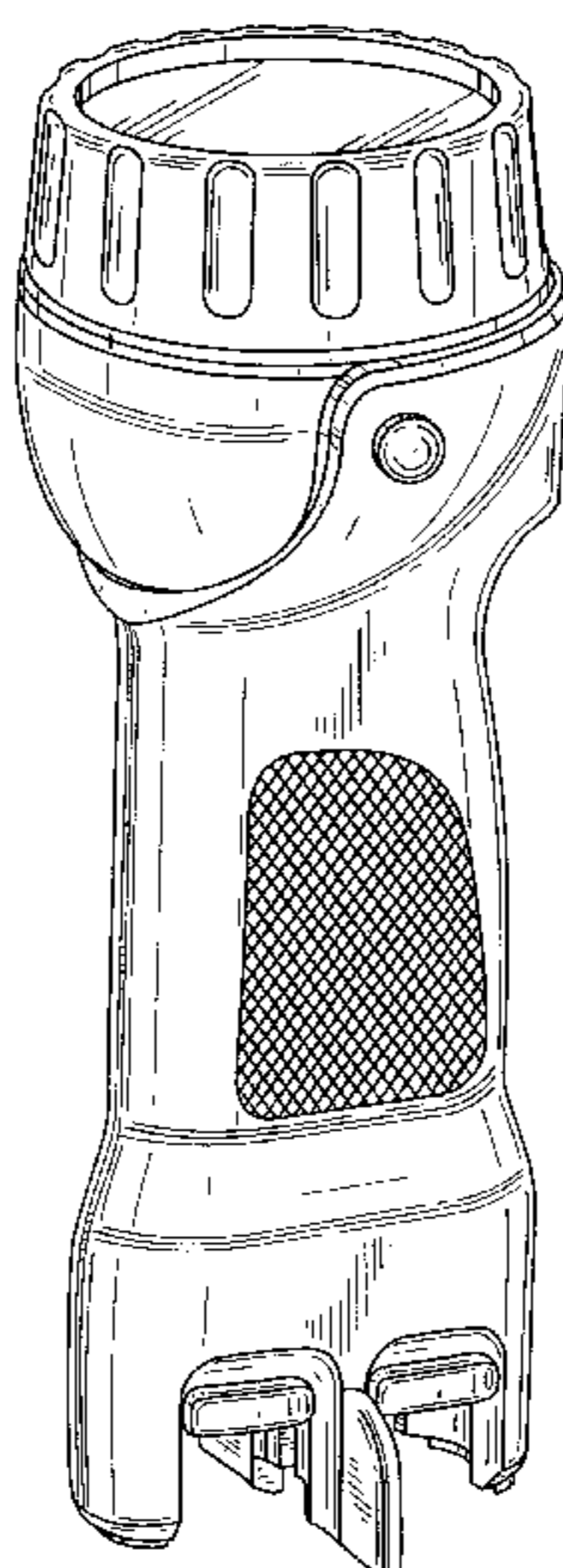

FIG. 1

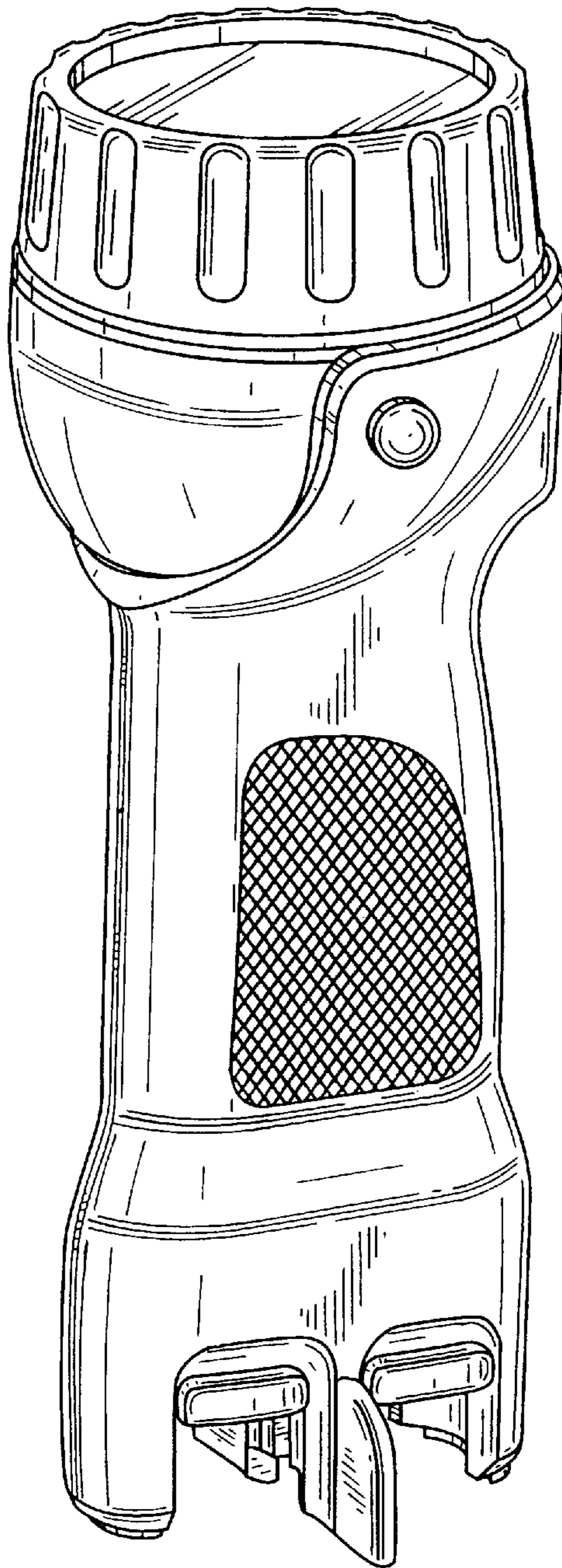

FIG. 2

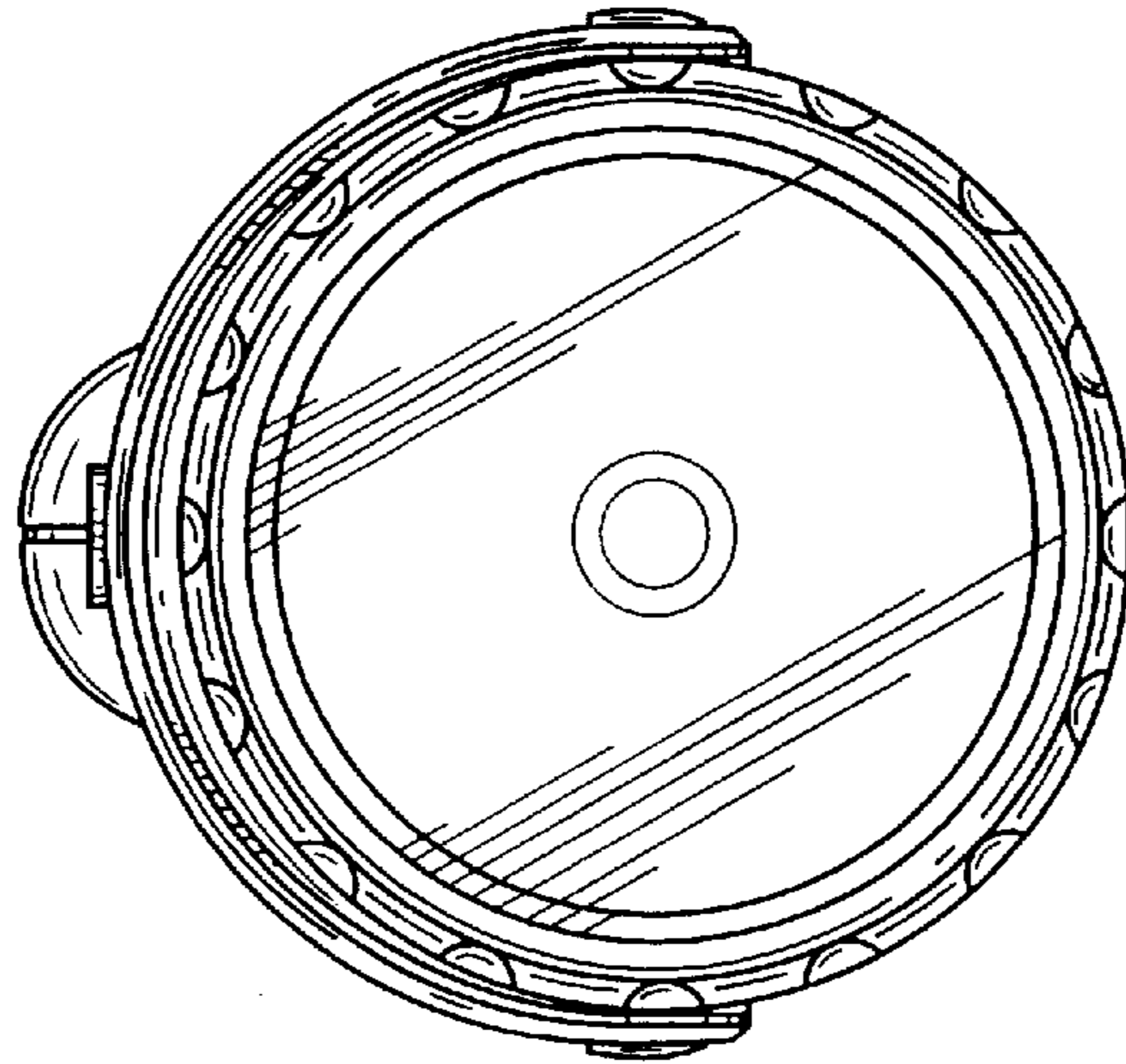

FIG. 3

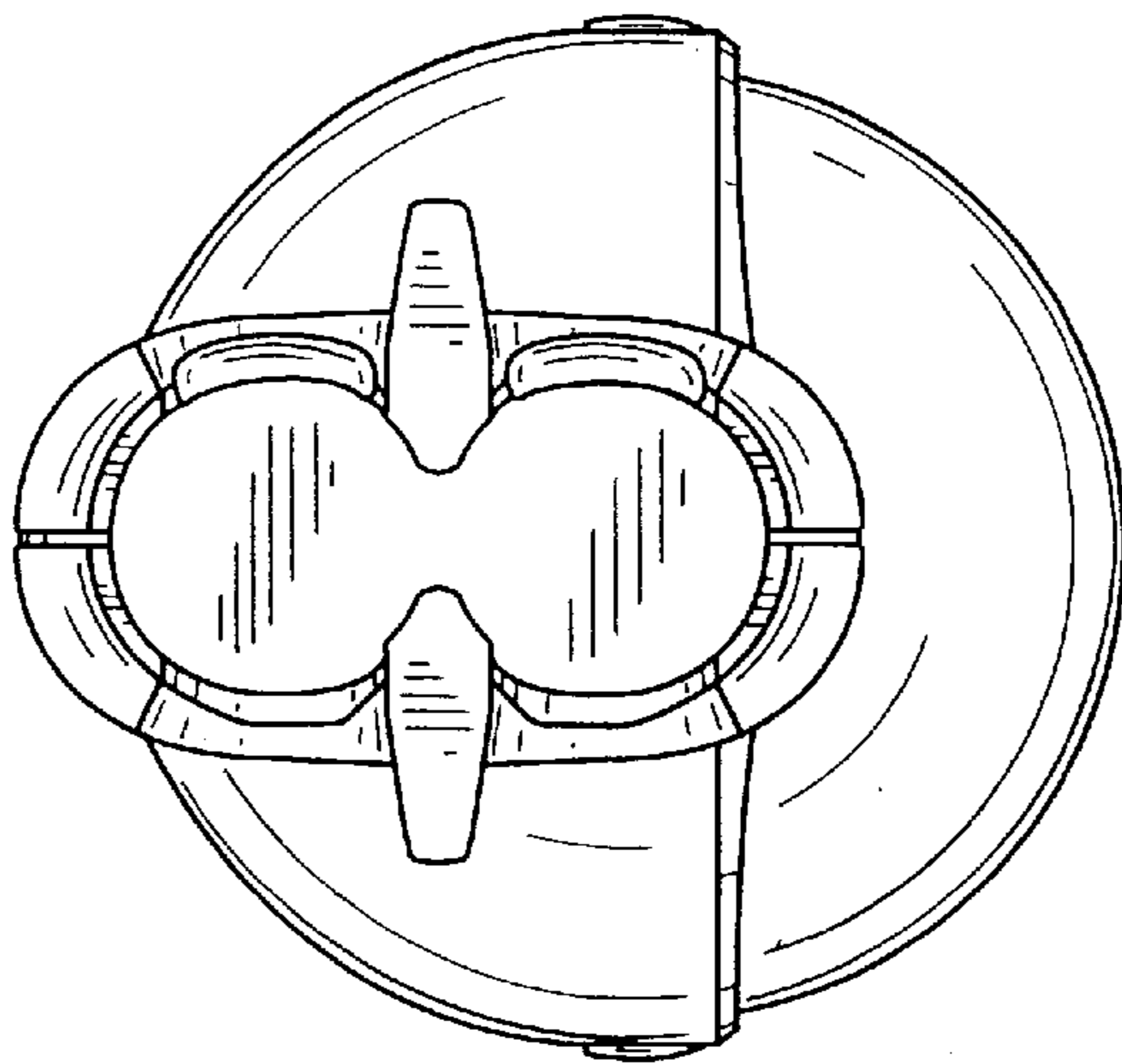



FIG. 4

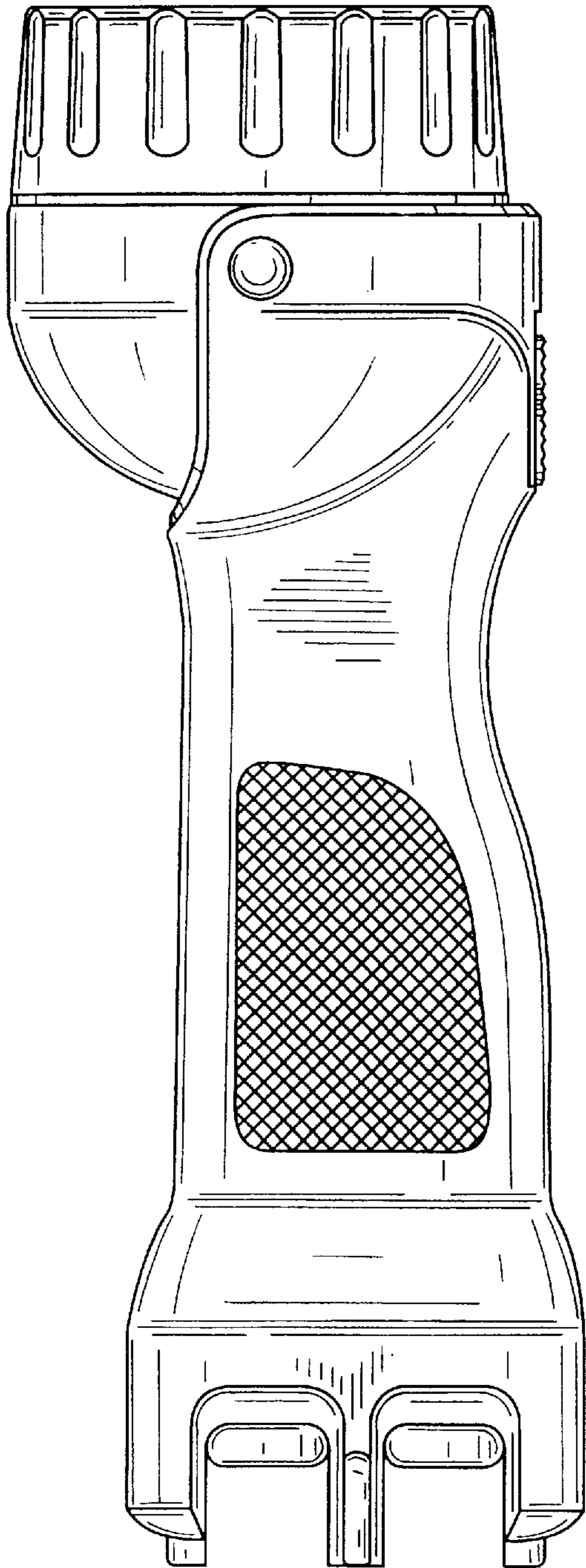

FIG. 5

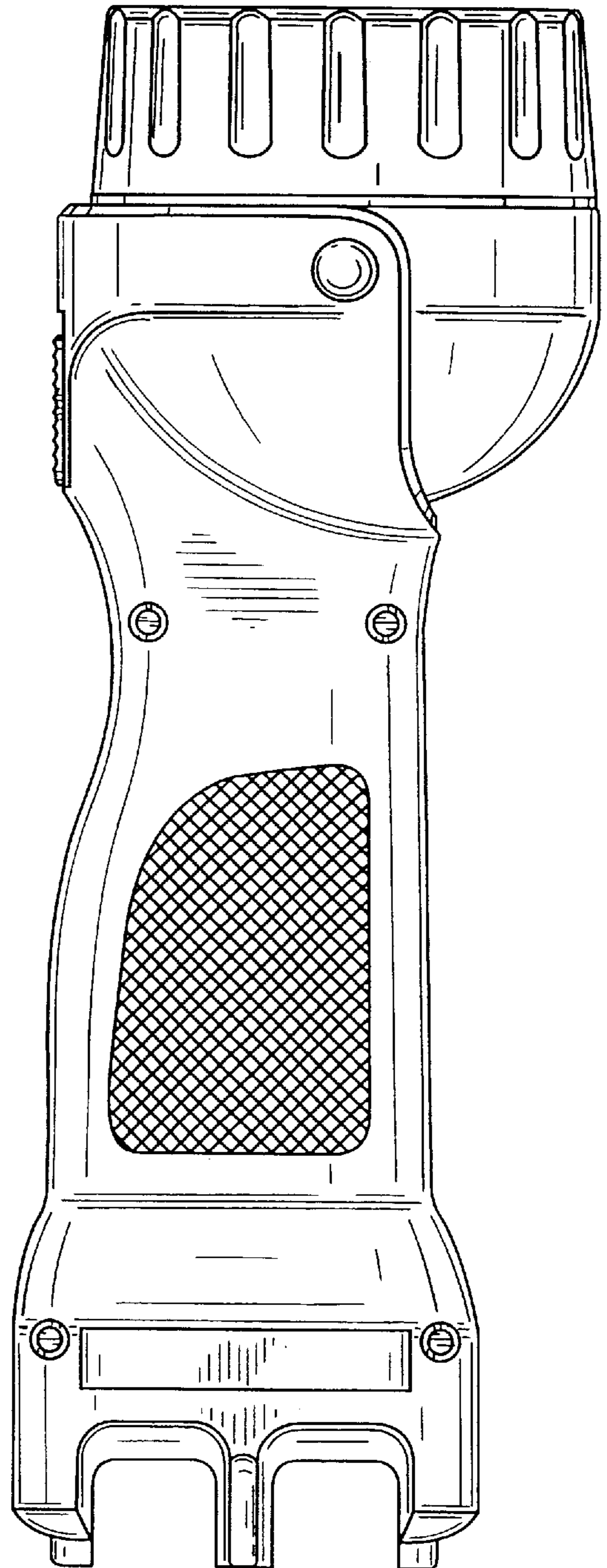

FIG. 6

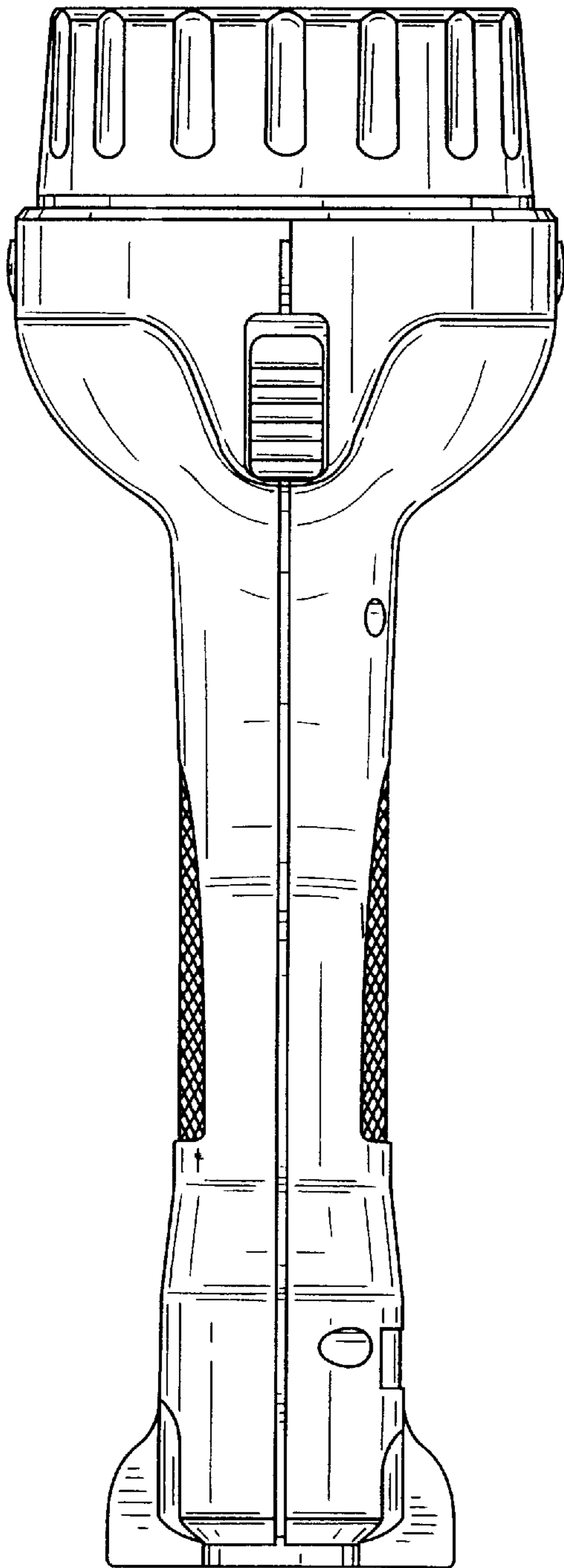

FIG. 7

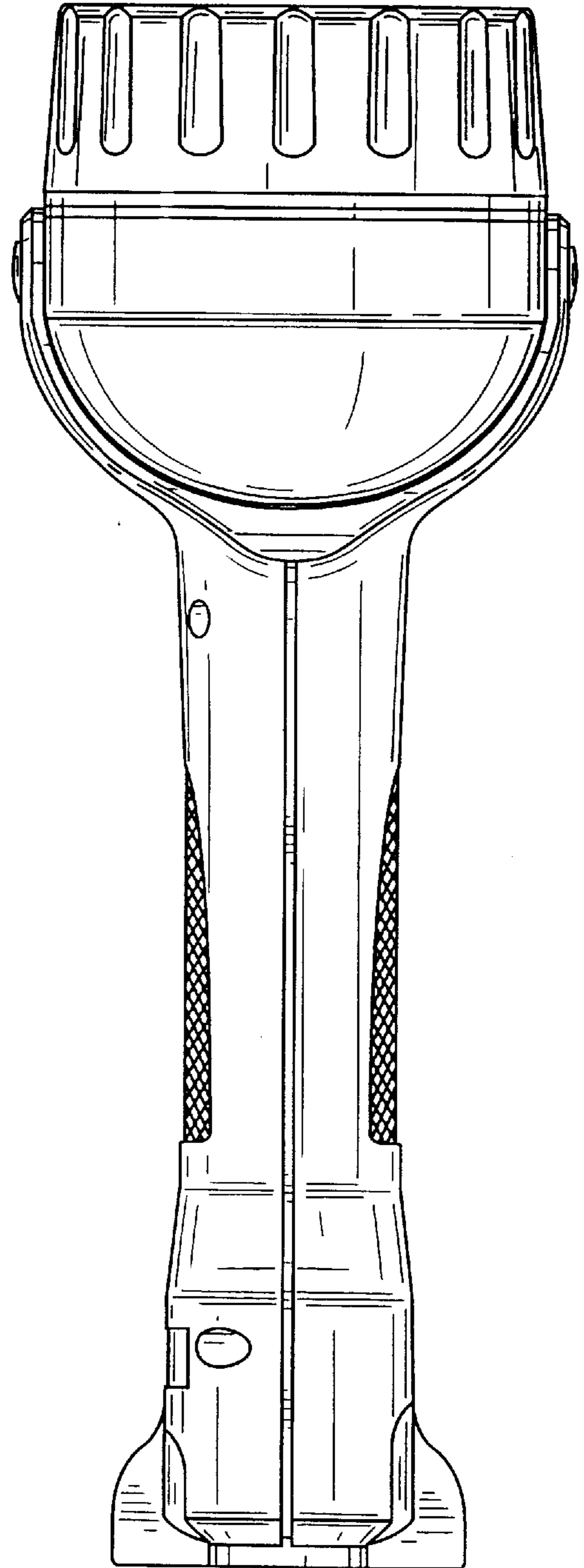

FIG. 8

