



US00D406352S

United States Patent [19]
Kleihues

[11] **Patent Number: Des. 406,352**

[45] **Date of Patent: **Mar. 2, 1999**

[54] **BUS STOP SHELTER**

[75] Inventor: **Paul Kleihues**, Berlin, Germany

[73] Assignee: **Wall Verkehrsanlagen GmbH**, Berlin, Germany

[**] Term: **14 Years**

[21] Appl. No.: **78,197**

[22] Filed: **Oct. 21, 1997**

[30] **Foreign Application Priority Data**

Apr. 21, 1997 [DE] Germany M 97 03 677.3

[51] **LOC (6) Cl.** **25-03**

[52] **U.S. Cl.** **D25/1**

[58] **Field of Search** D25/16, 1; 52/79.1

[56] **References Cited**

U.S. PATENT DOCUMENTS

D. 336,136 6/1993 Foster D25/1

5,363,608 11/1994 Conlan 52/79.1

Primary Examiner—Doris Clark
Attorney, Agent, or Firm—Antonelli, Terry, Stout & Kraus, LLP

[57] **CLAIM**

The ornamental design for bus stop shelter, as shown and described.

DESCRIPTION

FIG. 1 is a front perspective view of a bus stop shelter showing my new design;
FIG. 2 is a top perspective view thereof;
FIG. 3 is a rear elevational view thereof;
FIG. 4 is a front elevational view thereof;
FIG. 5 is a side elevational view thereof;
FIG. 6 is a front perspective view of a second embodiment of a bus stop shelter showing my new design;
FIG. 7 is a top perspective view thereof;
FIG. 8 is a front elevational view thereof; and,
FIG. 9 is a side elevational view thereof.

The inscription illustrated by broken lines is for illustrative purposes only and forms no part of the claimed design.

1 Claim, 6 Drawing Sheets

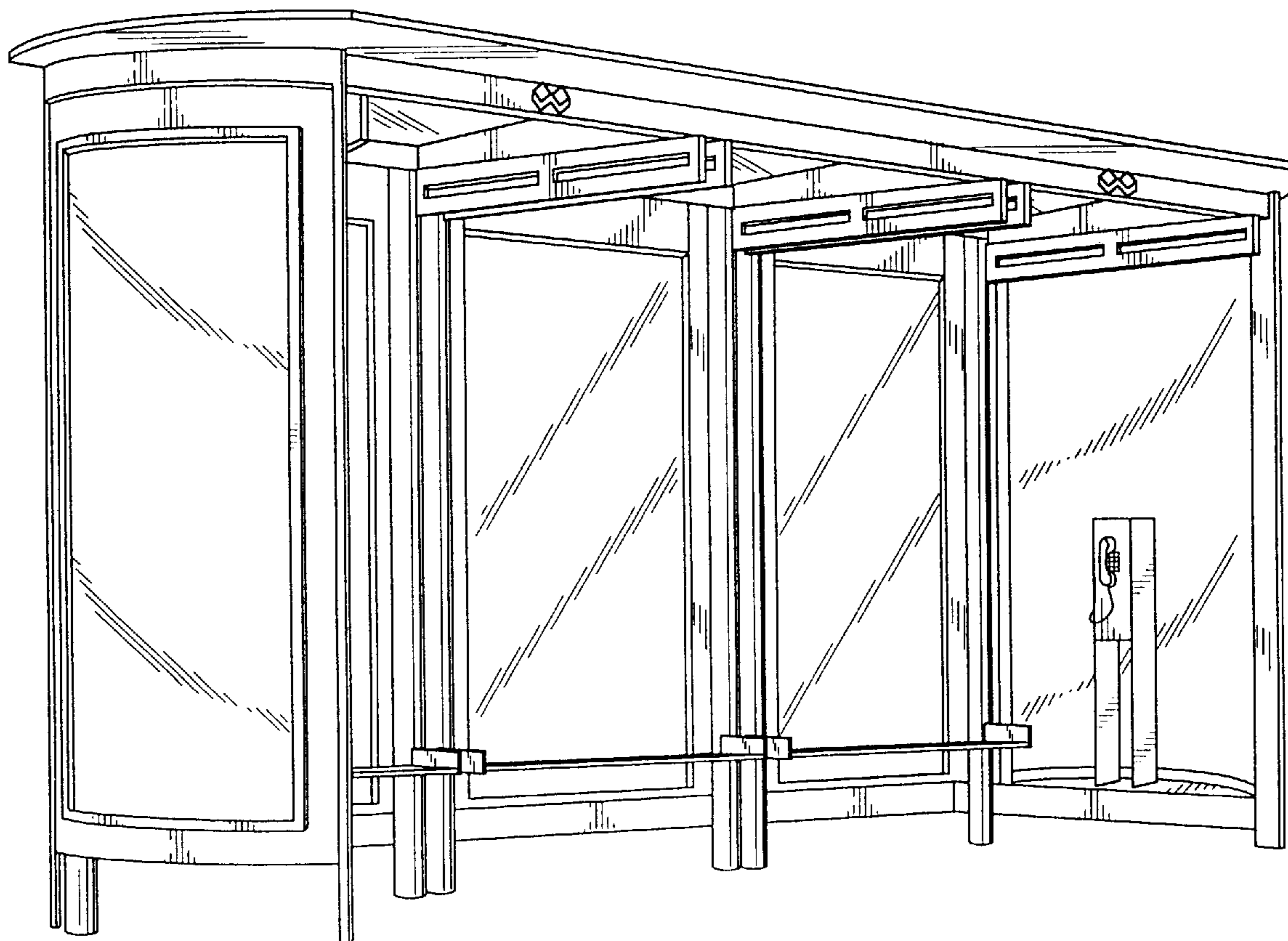

FIG. 1

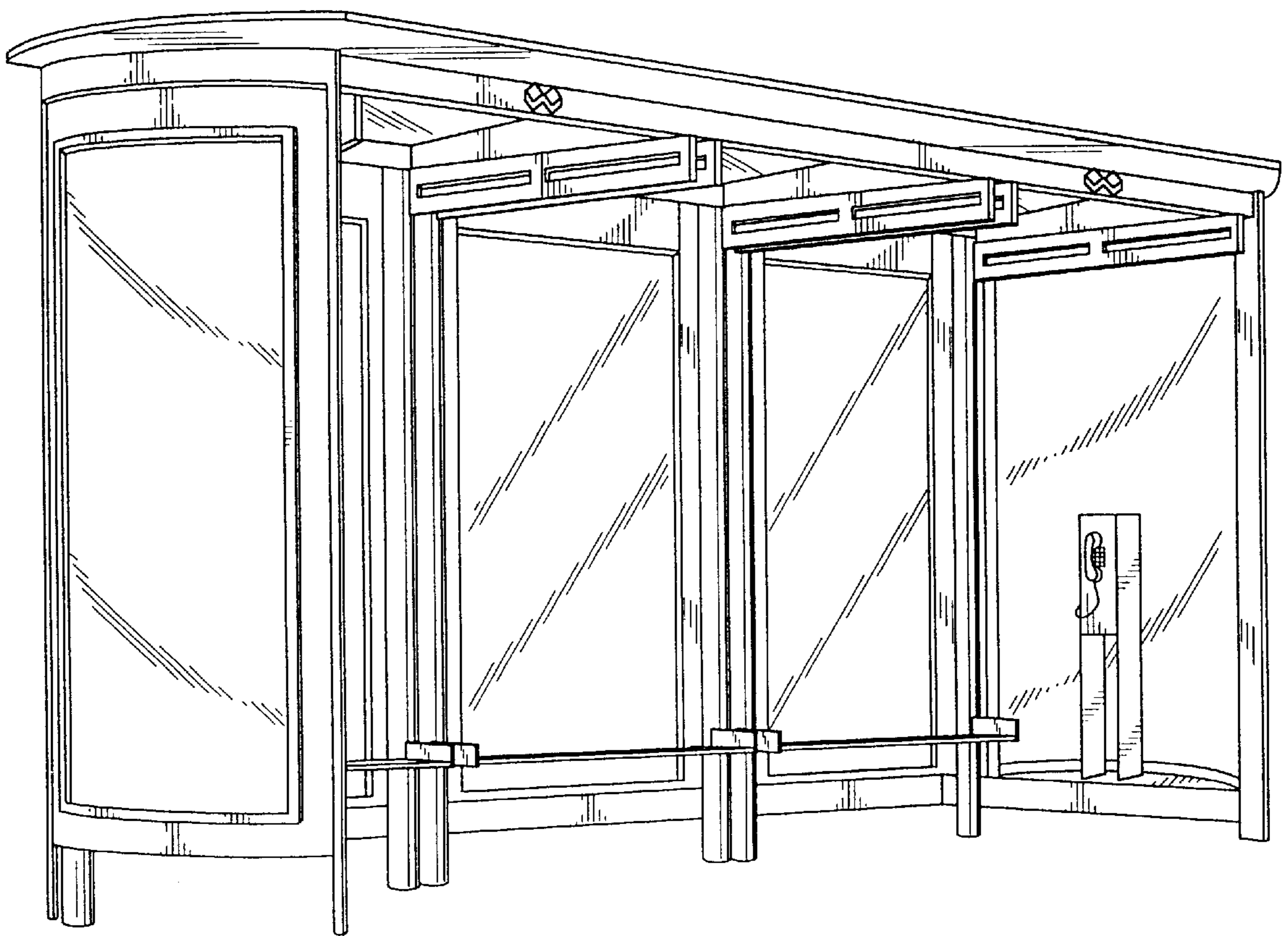

FIG. 3

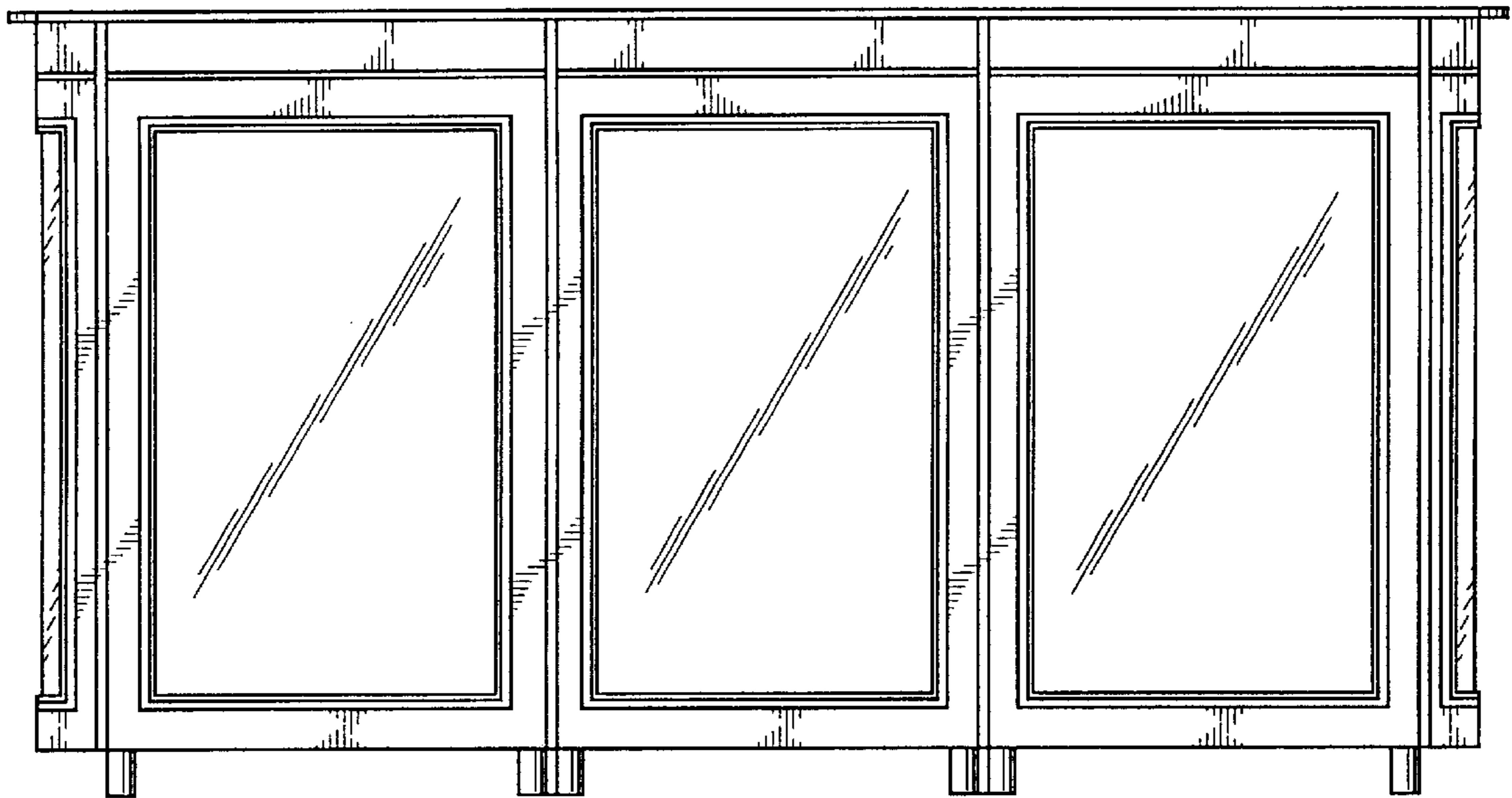

FIG. 2

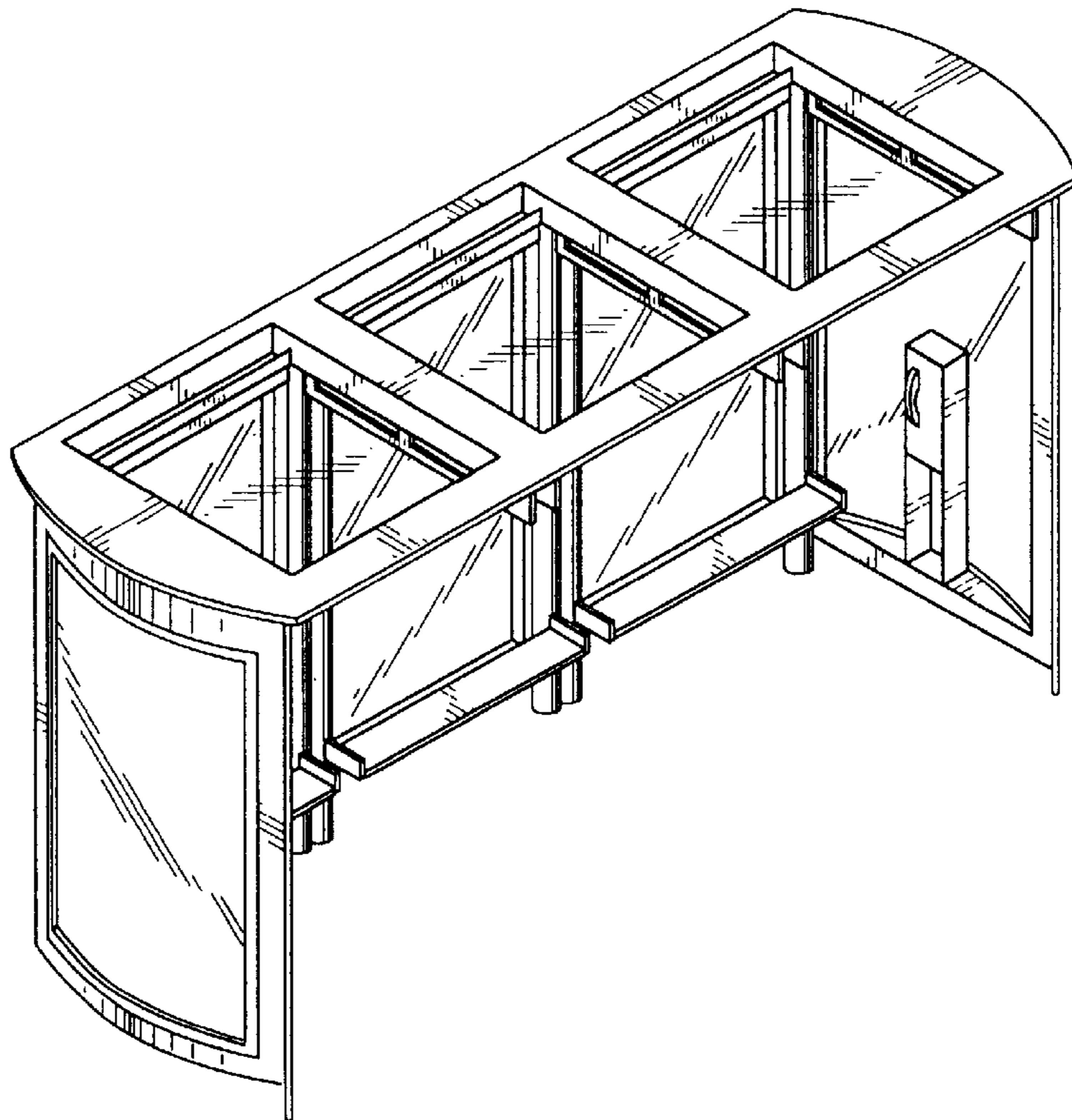

FIG. 4

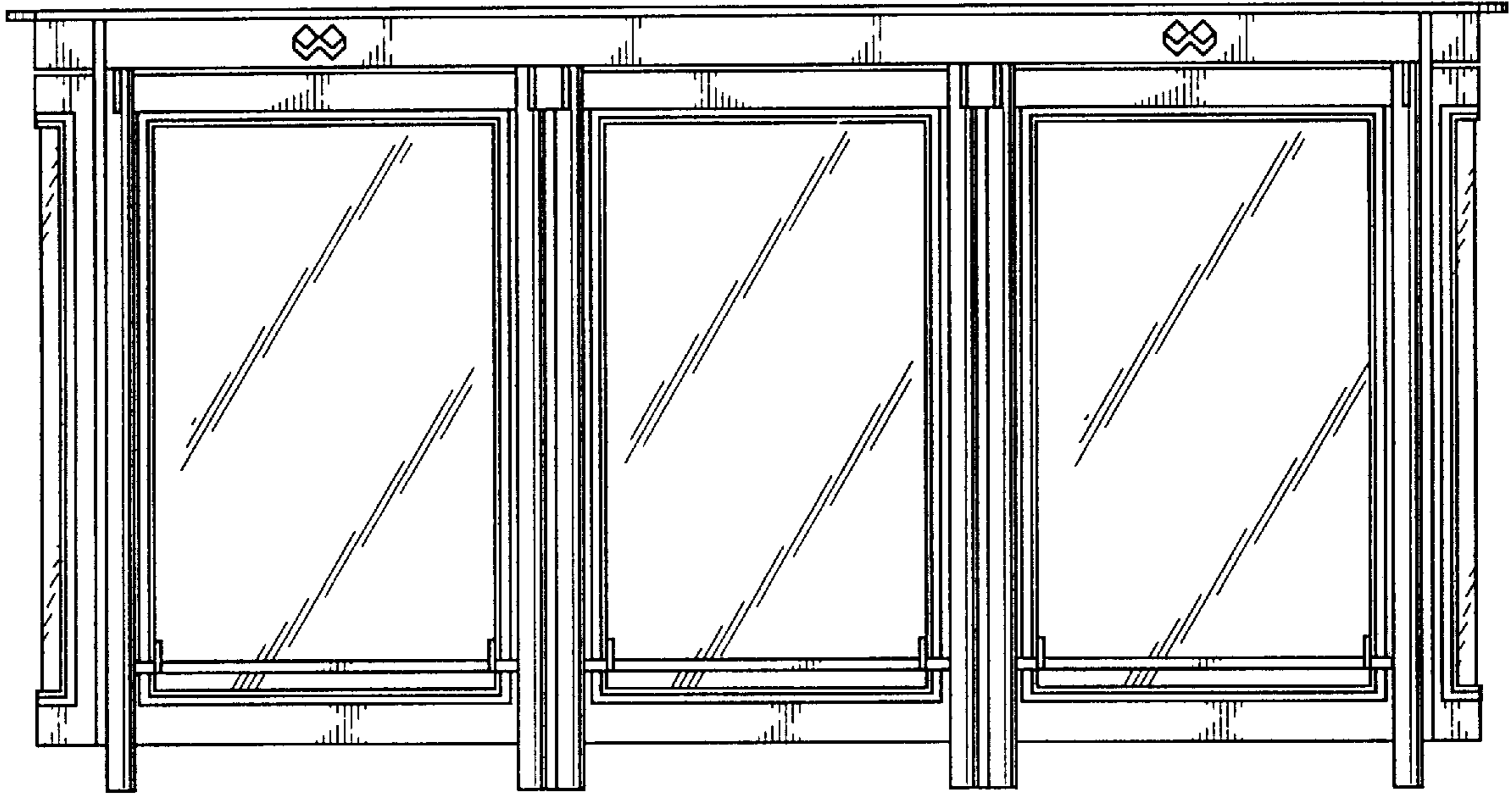

FIG. 5

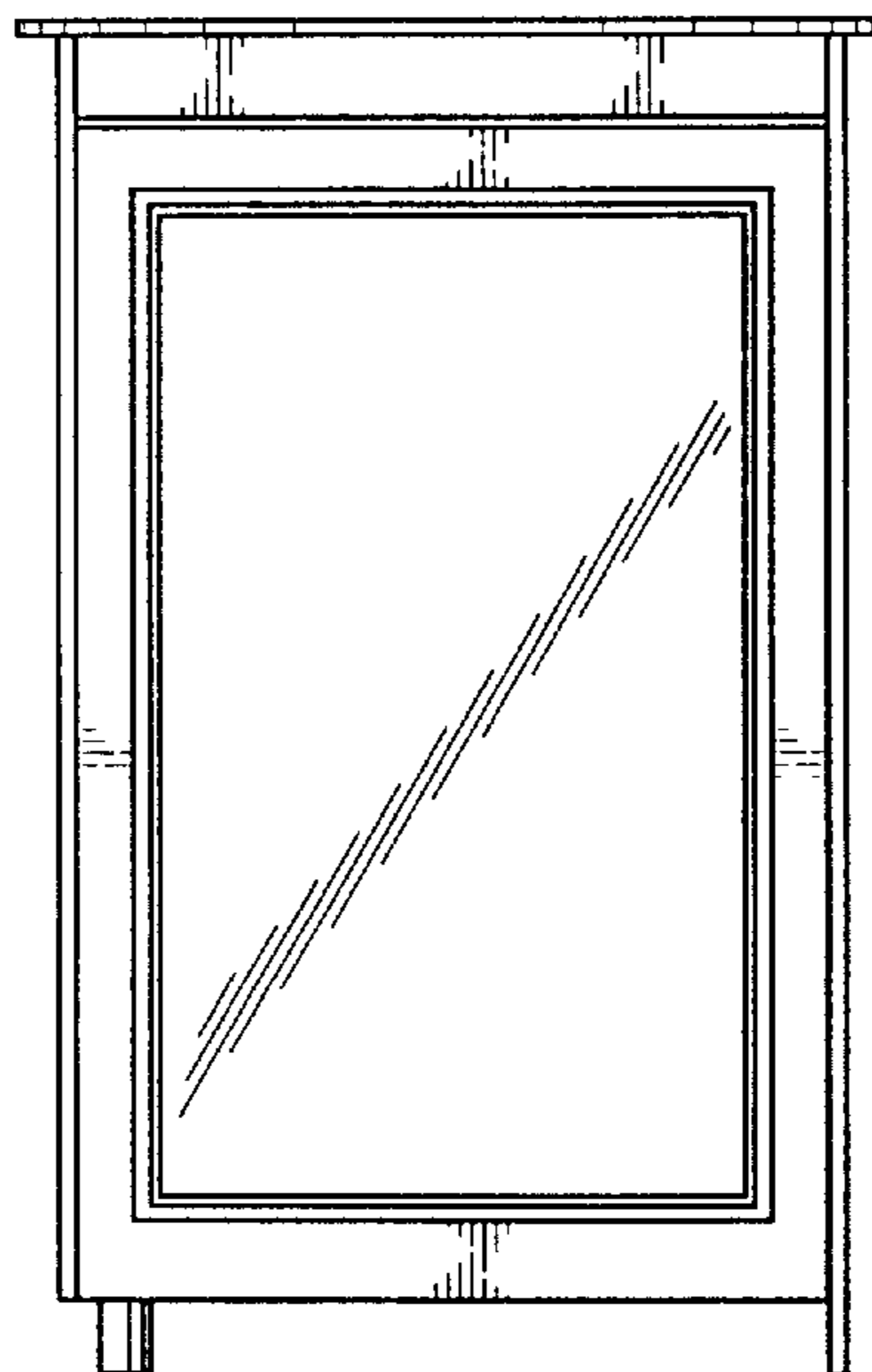

FIG. 6

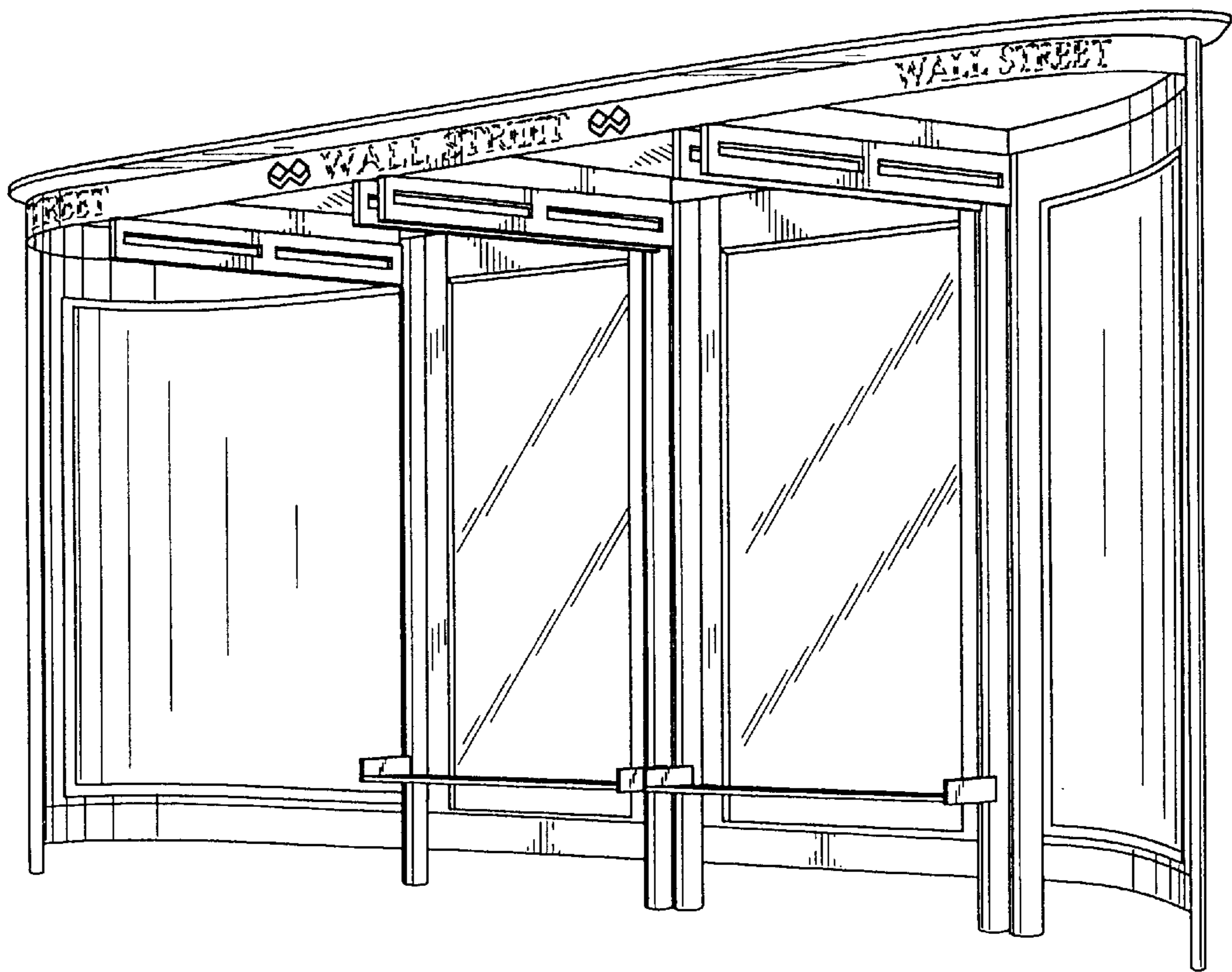

FIG. 9

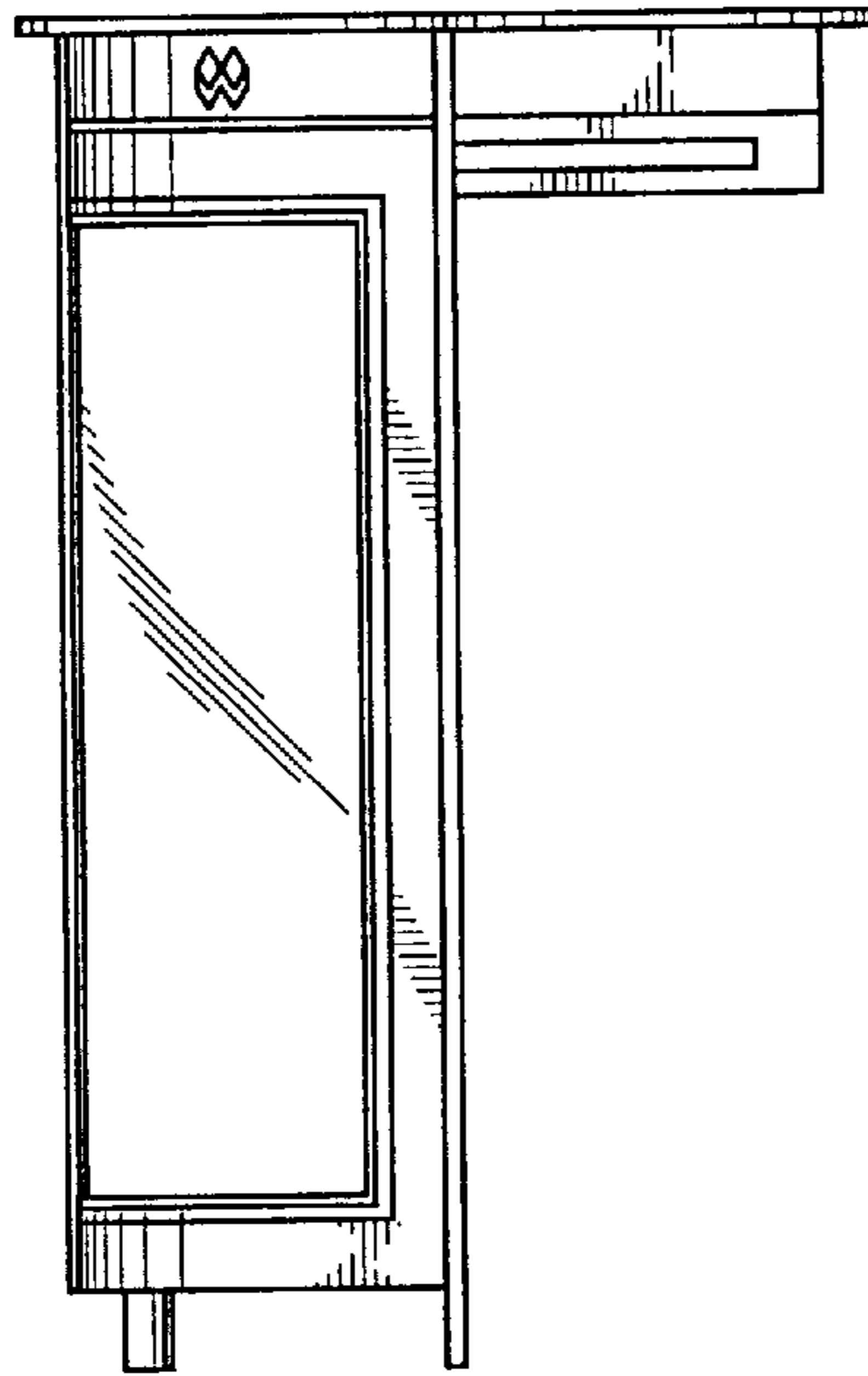

FIG. 7

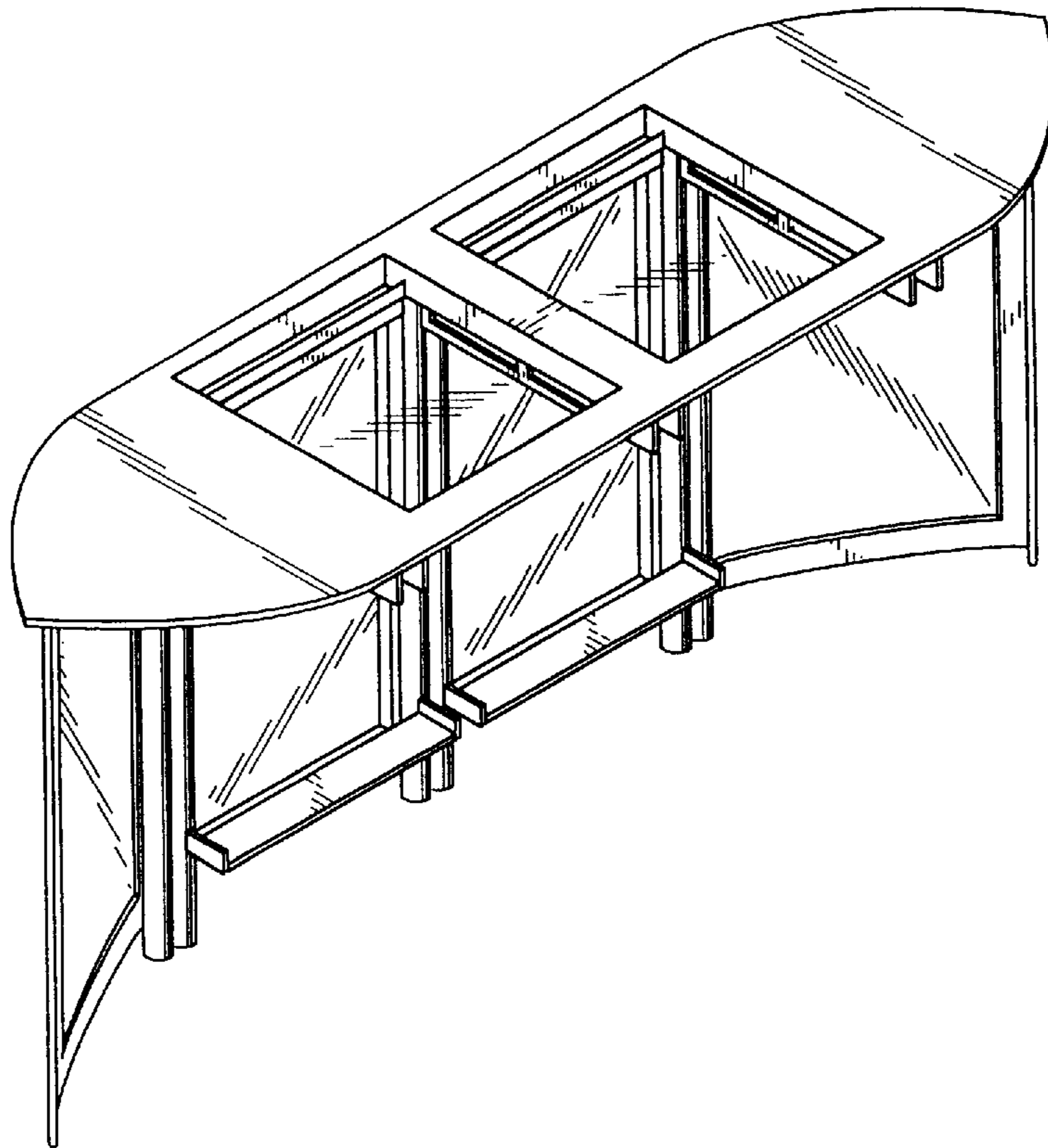

FIG. 8

