

US00D406294S

# United States Patent [19]

[11] Patent Number: Des. 406,294

Burrows

[45] Date of Patent: \*\*\*Mar. 2, 1999

[54] IRON-TYPE HEAD FOR A GOLF CLUB

[57] CLAIM

[76] Inventor: **Bruce D. Burrows**, 25555 W. Ave.  
Stanford, Valencia, Calif. 91352-1101

The ornamental design for an iron-type head for a golf club,  
as shown and described.

[\*] Notice: The term of this patent shall not extend  
beyond the expiration date of Pat. No. D.  
387,113.

DESCRIPTION

[\*\*] Term: **14 Years**

FIG. 1 is a perspective view showing the rear and right sides  
of an iron-type head for a golf club embodying the new  
design;

[21] Appl. No.: **77,713**

FIG. 2 is a front elevational view thereof;

[22] Filed: **Oct. 9, 1997**

FIG. 3 is a rear elevational view thereof;

[51] LOC (6) Cl. .... **21-02**

FIG. 4 is a top plan view thereof;

[52] U.S. Cl. .... **D21/748**

FIG. 5 is a bottom plan view thereof;

[58] Field of Search ..... D21/747-752;  
473/324, 327, 328, 350

FIG. 6 is a right side elevational view thereof;

FIG. 7 is a left side elevational view thereof;

FIG. 8 is a sectional view taken on the line 8—8 of FIG. 3;  
FIG. 9 is an enlarged sectional view taken on the line 9—9  
of FIG. 3;

[56] **References Cited**

U.S. PATENT DOCUMENTS

D. 318,703	7/1991	Shearer	.....	D21/748
D. 387,113	12/1997	Burrows	.....	D21/748
D. 392,356	3/1998	Burrows	.....	D21/748
5,447,307	9/1995	Antonious	.....	473/350

FIG. 10 is a perspective view showing the rear and right  
sides of an alternative form of my new design, the front,  
right and left side elevational views and the top and bottom  
plan views being identical to the embodiment of FIGS. 1-7;  
FIG. 11 is a rear elevational view of the embodiment of FIG.  
10;

*Primary Examiner*—Mitchell I. Siegel  
*Attorney, Agent, or Firm*—Kelly Bauersfeld Lowry &  
Kelley, LLP

FIG. 12 is a sectional view taken on the line 12—12 of FIG.  
11; and,  
FIG. 13 is an enlarged sectional view taken on the line  
13—13 of FIG. 11.

**1 Claim, 6 Drawing Sheets**

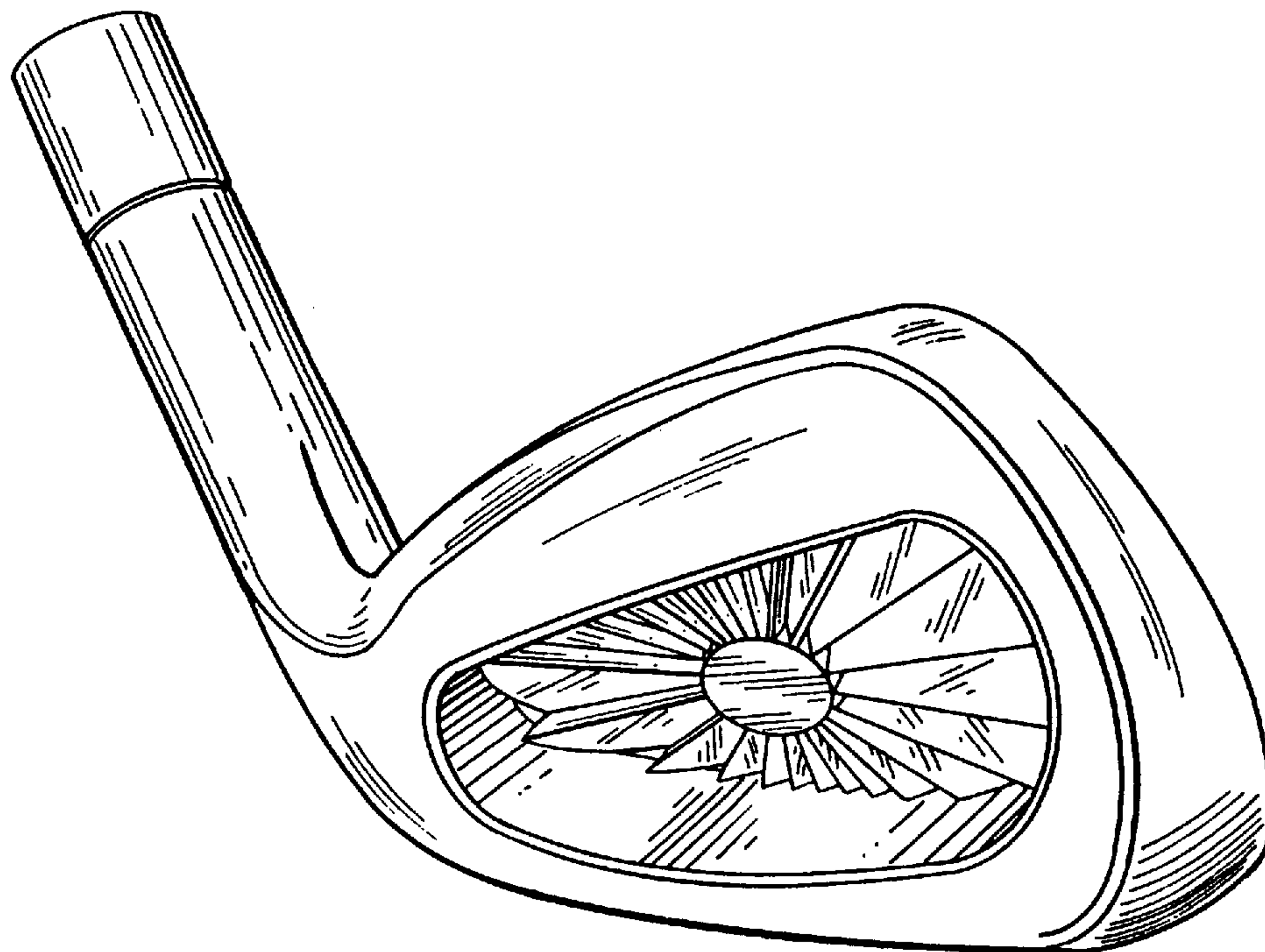

FIG. 1

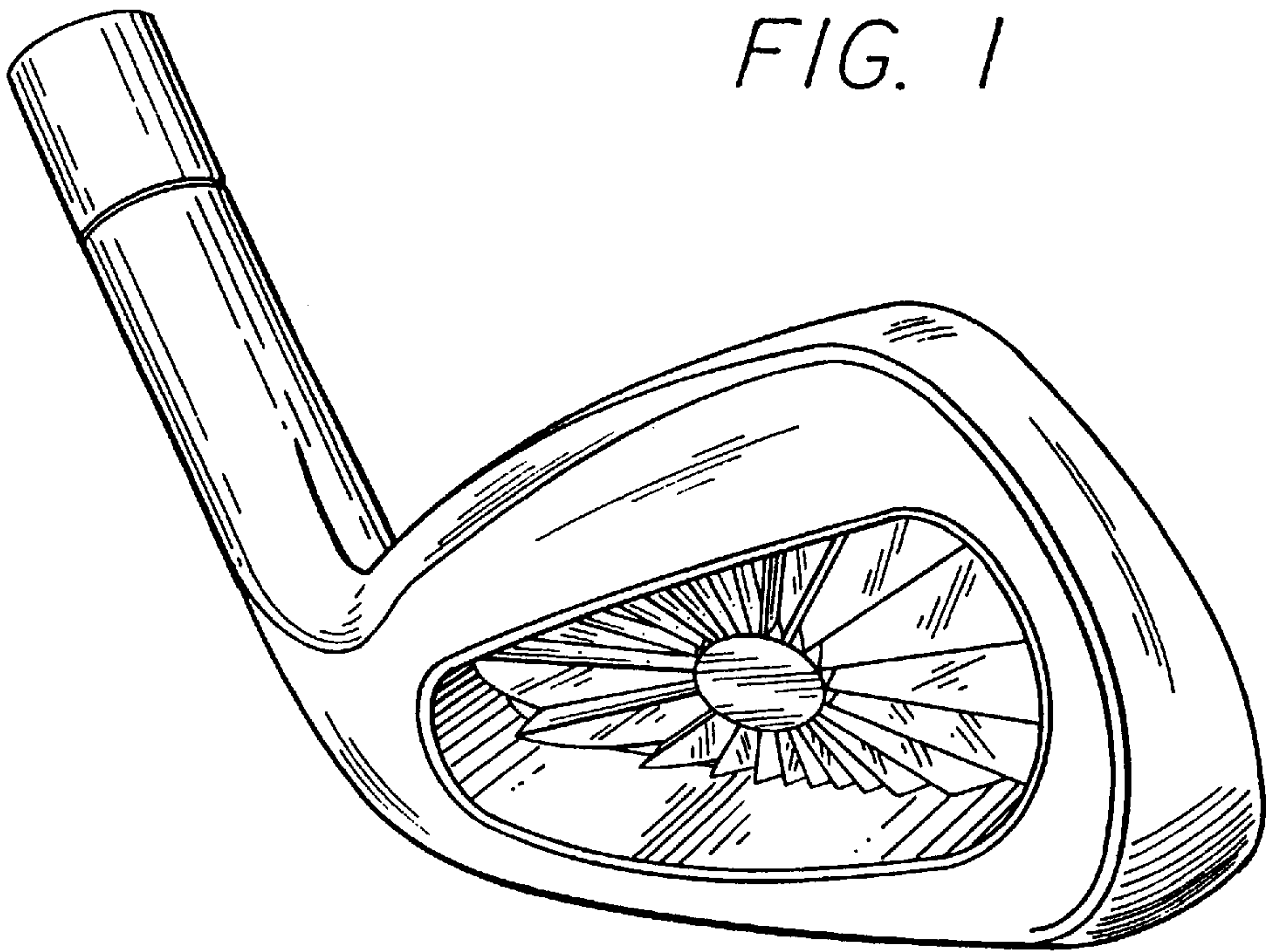

FIG. 2

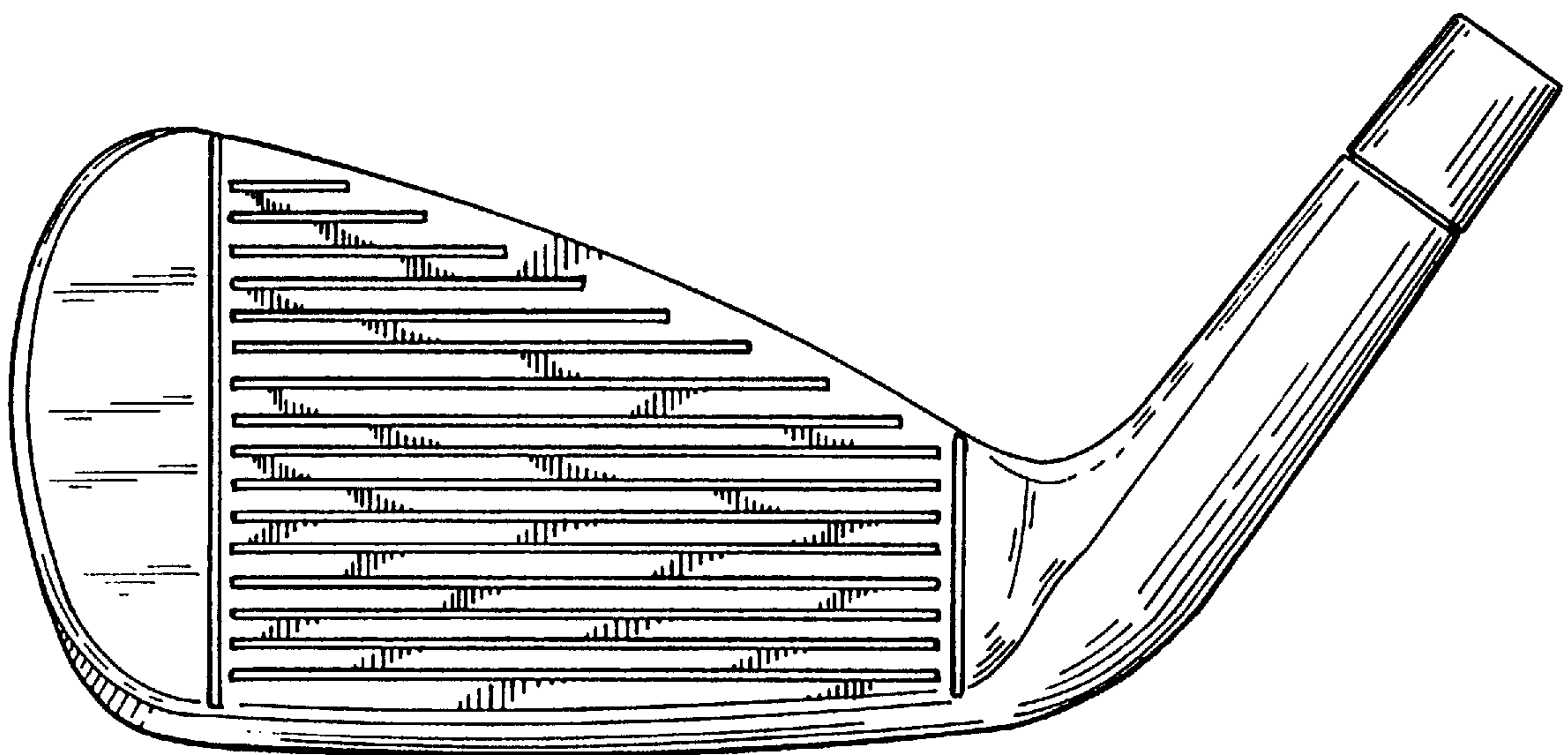

FIG. 3

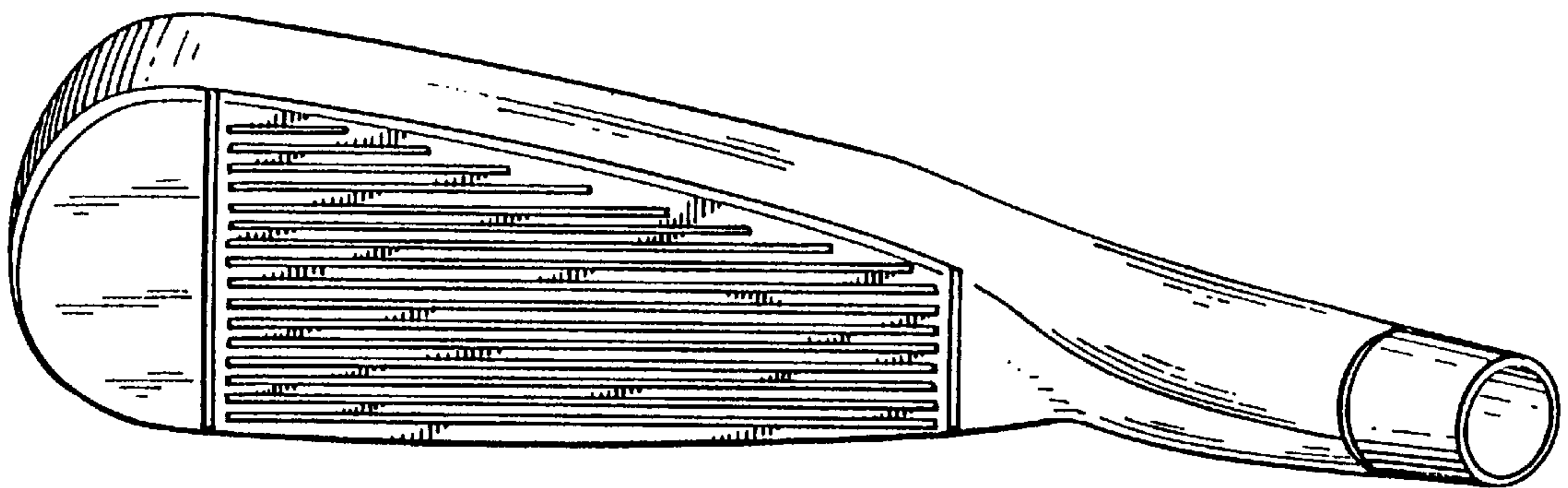
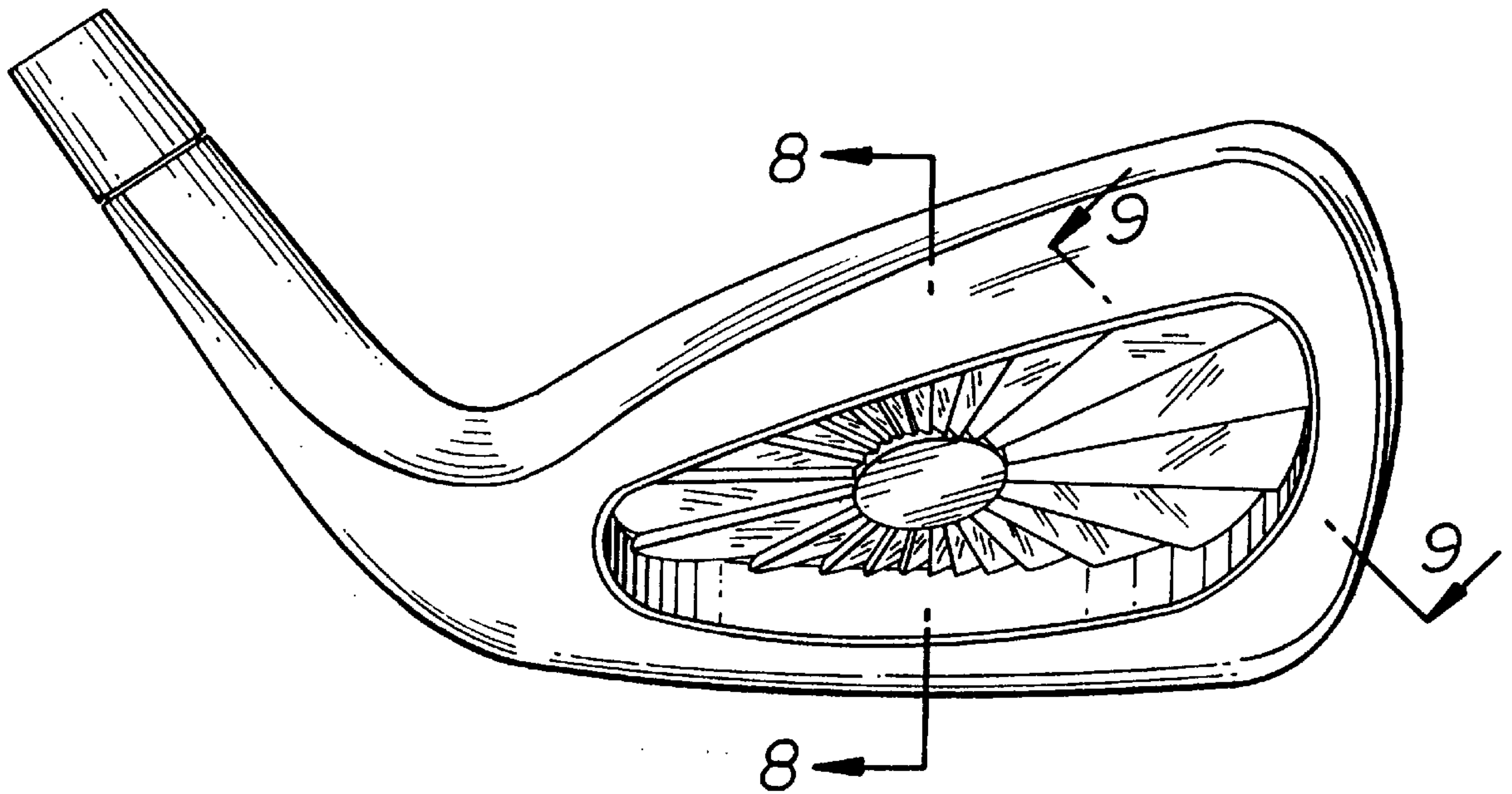

FIG. 4



FIG. 5

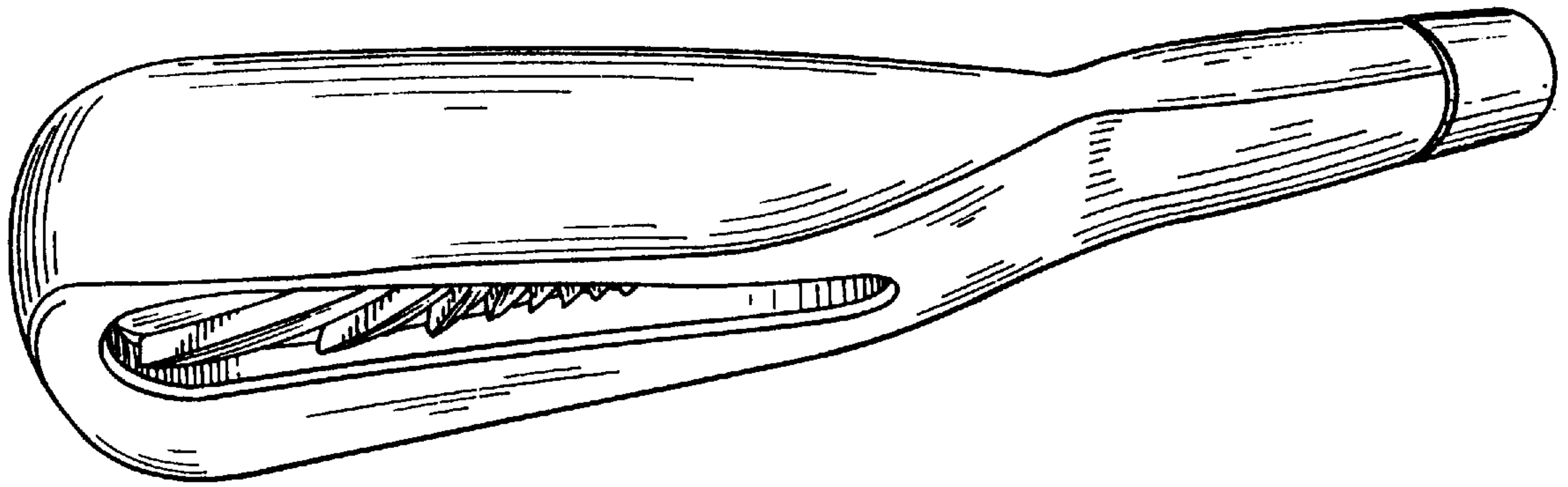

FIG. 6

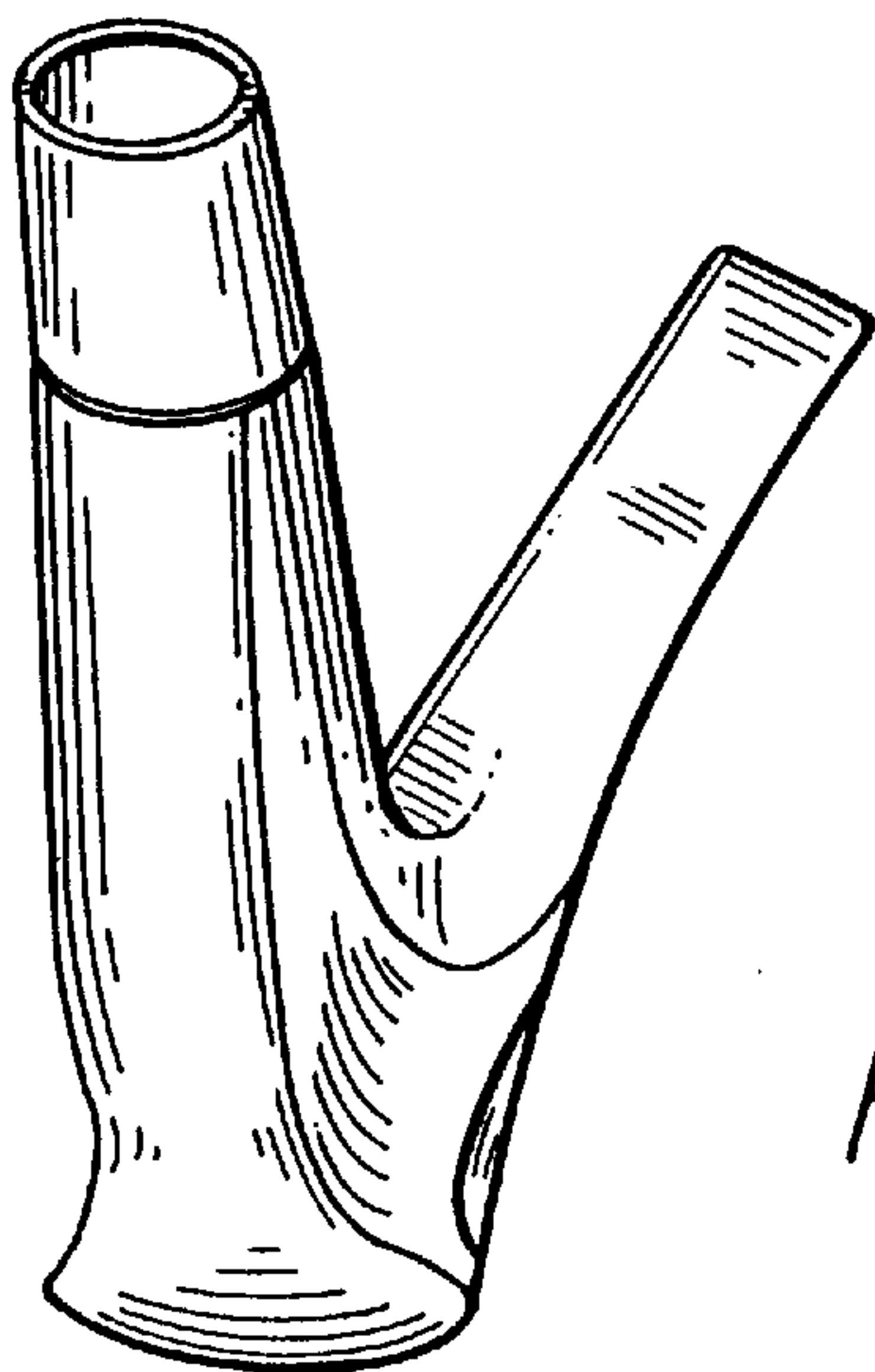
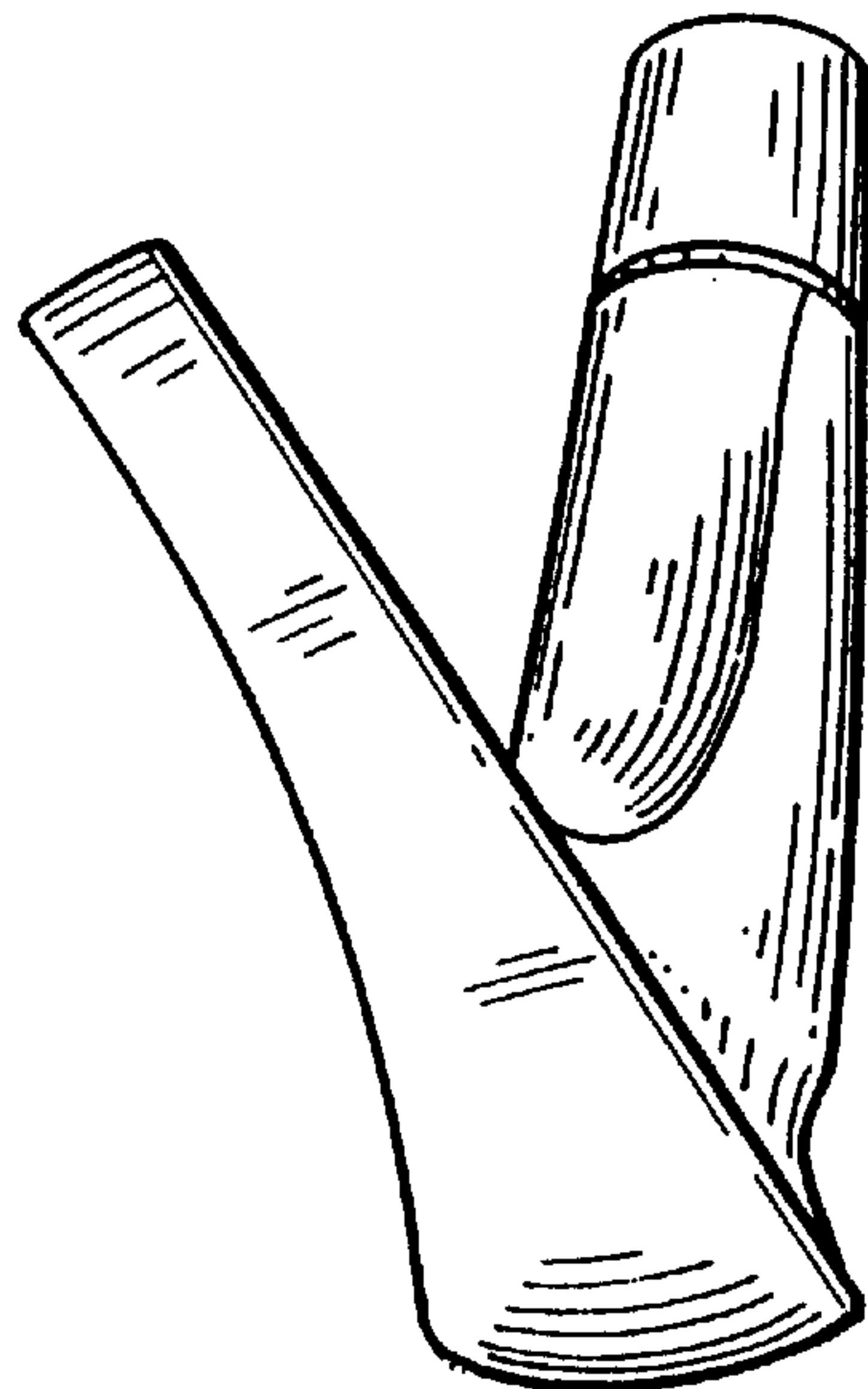

FIG. 7

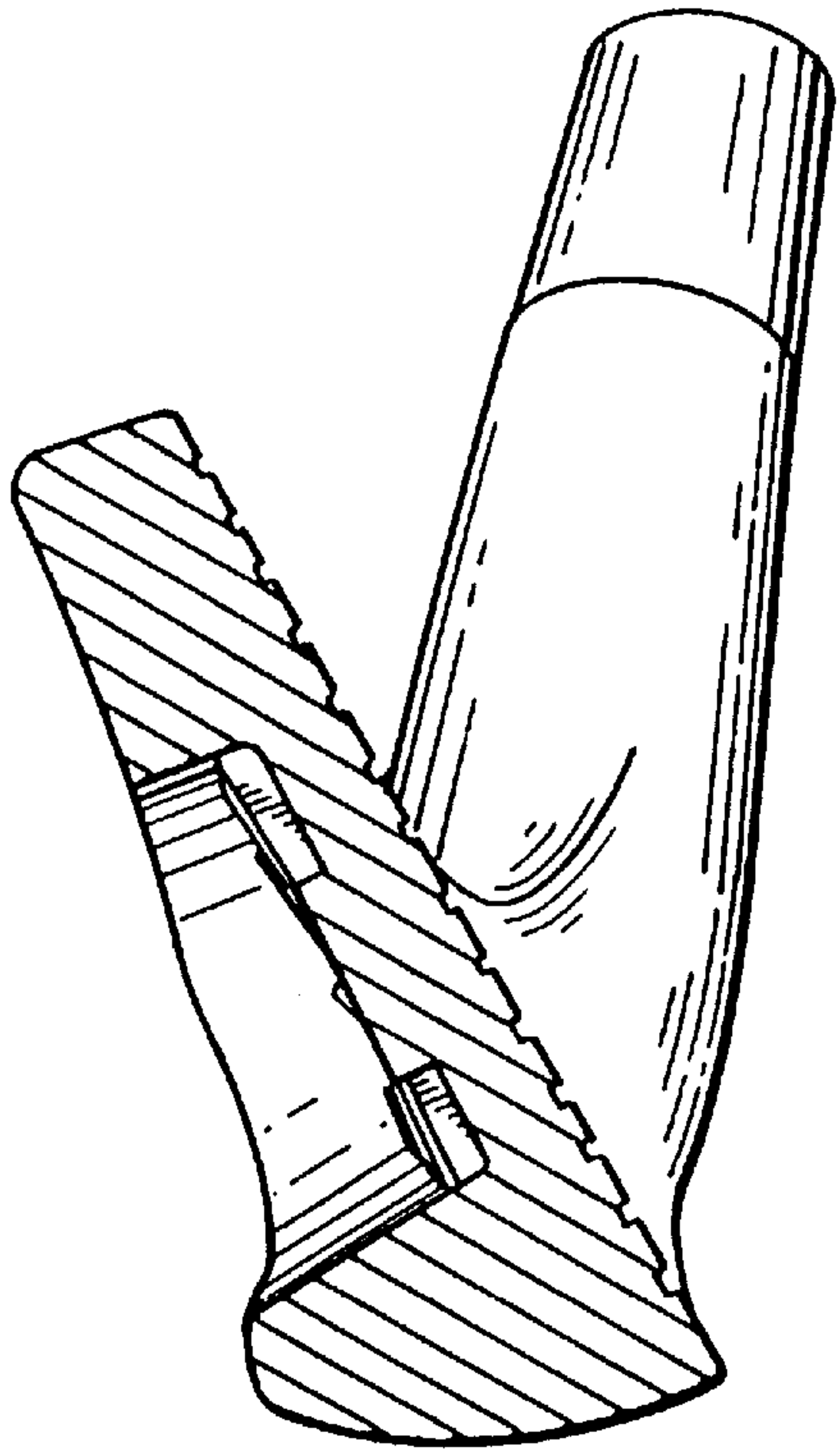

FIG. 8

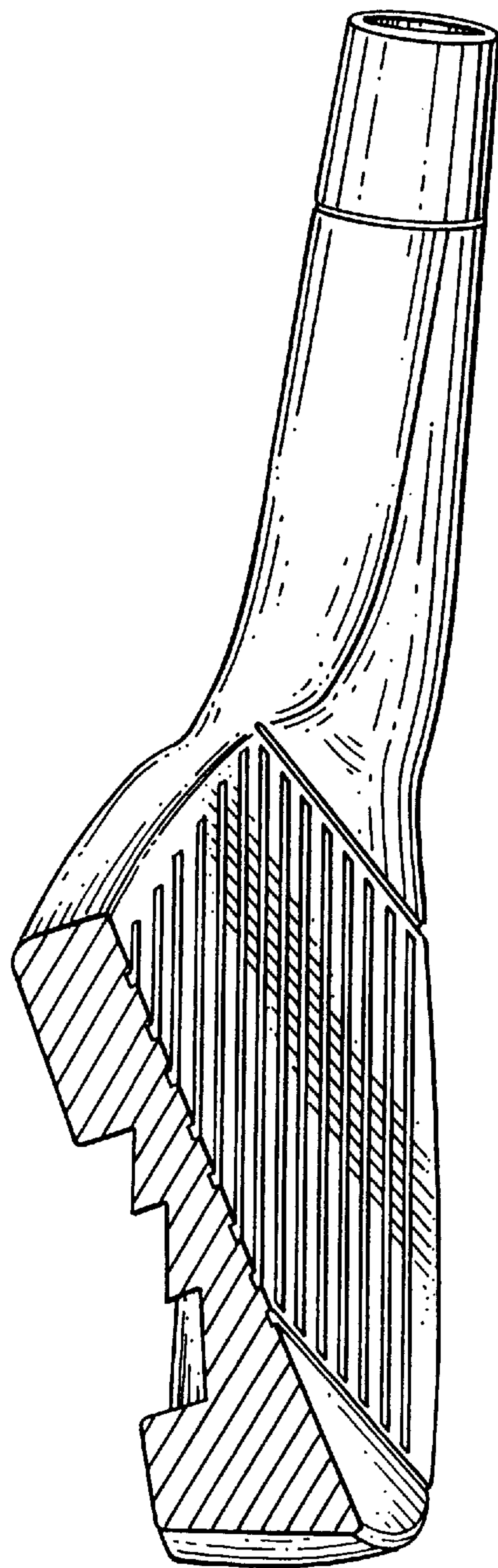

FIG. 9

FIG. 10

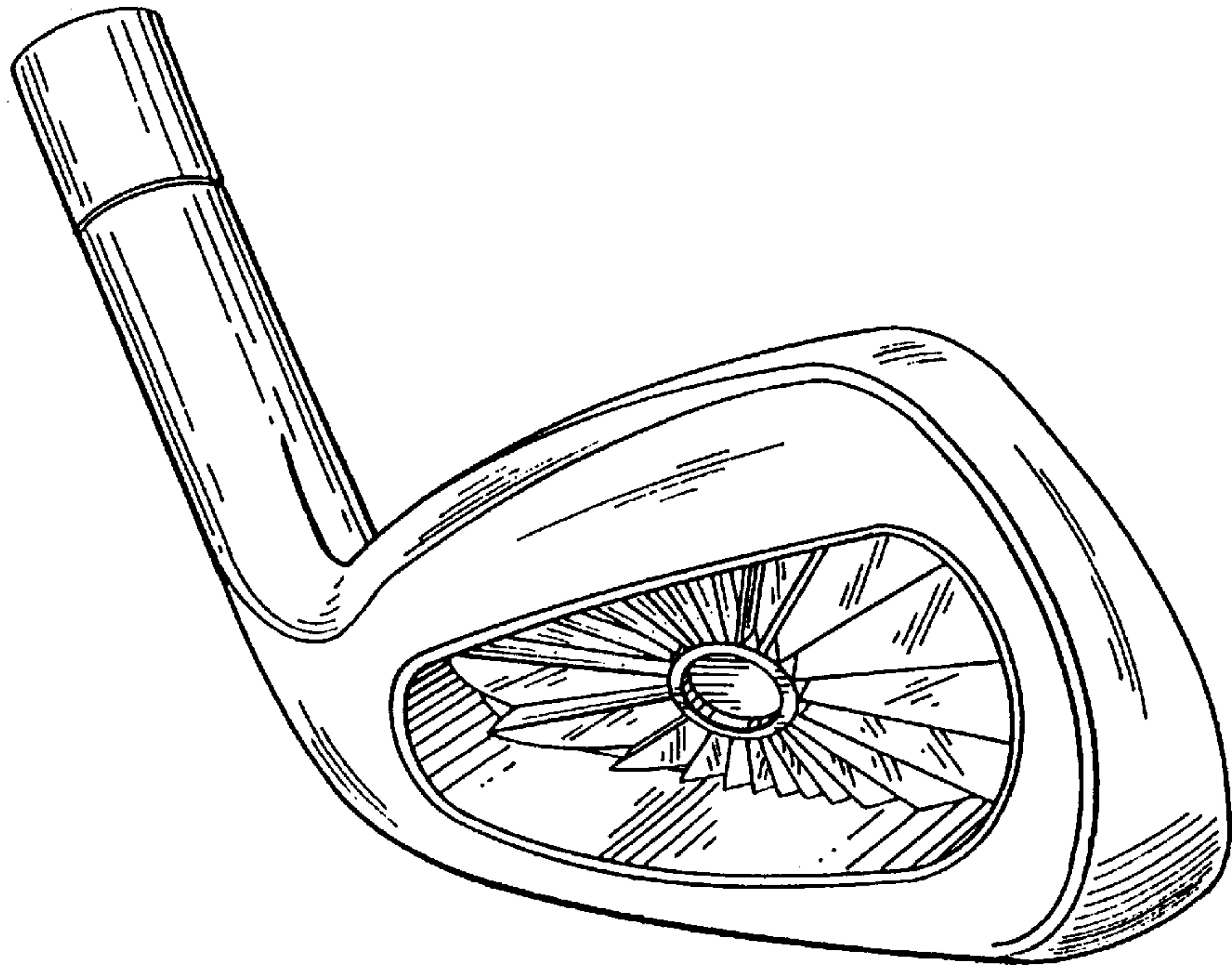
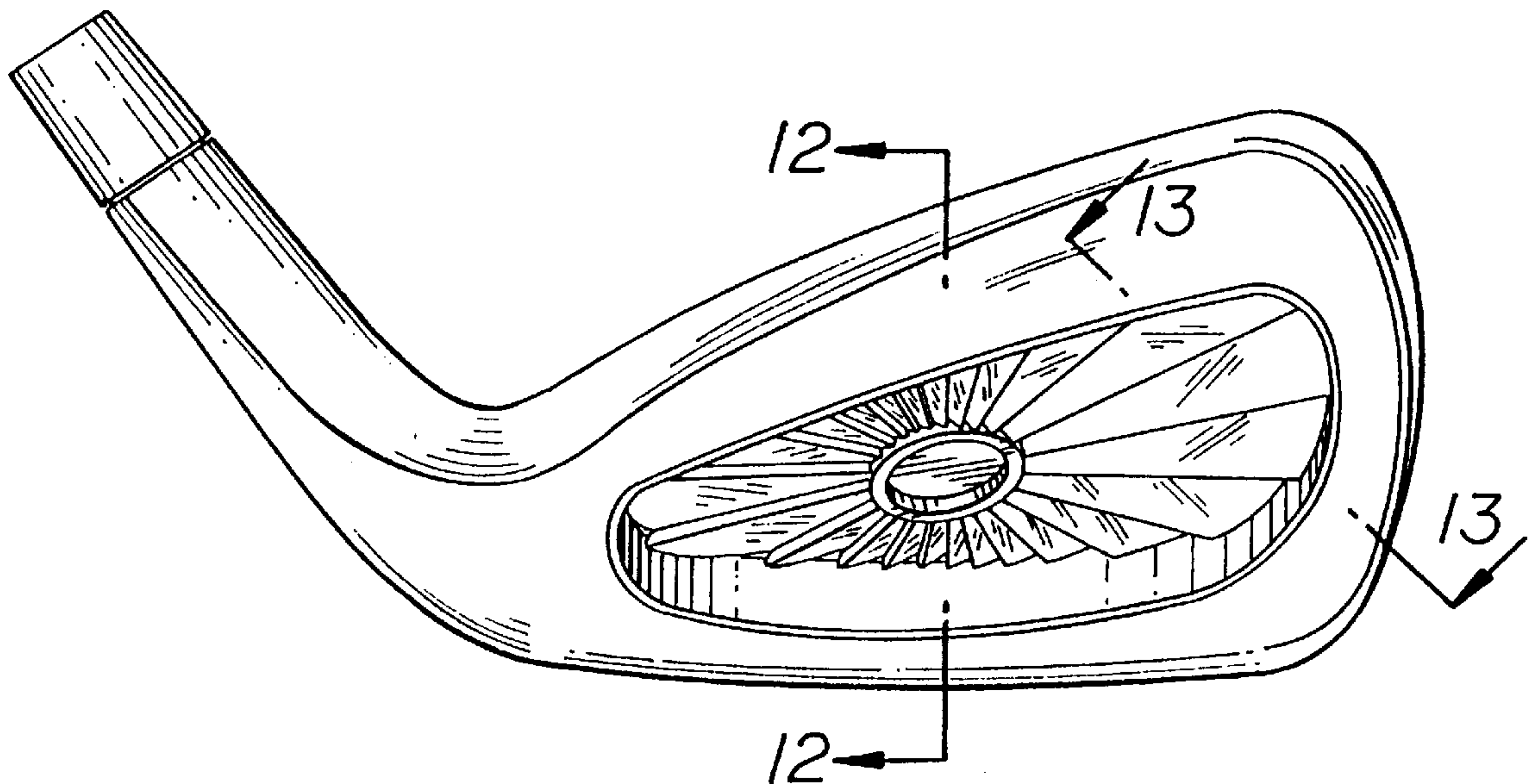

FIG. 11



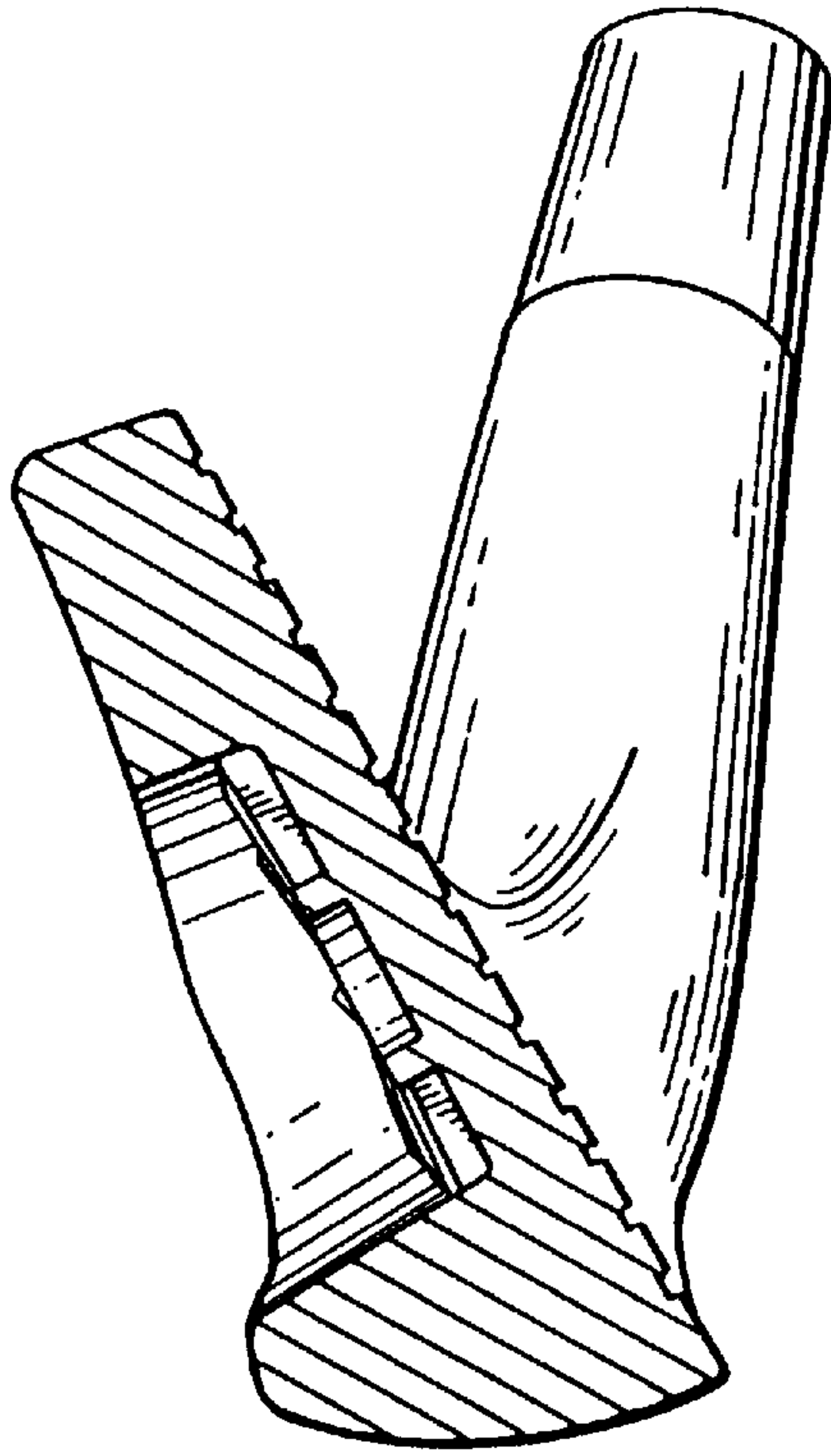

FIG. 12

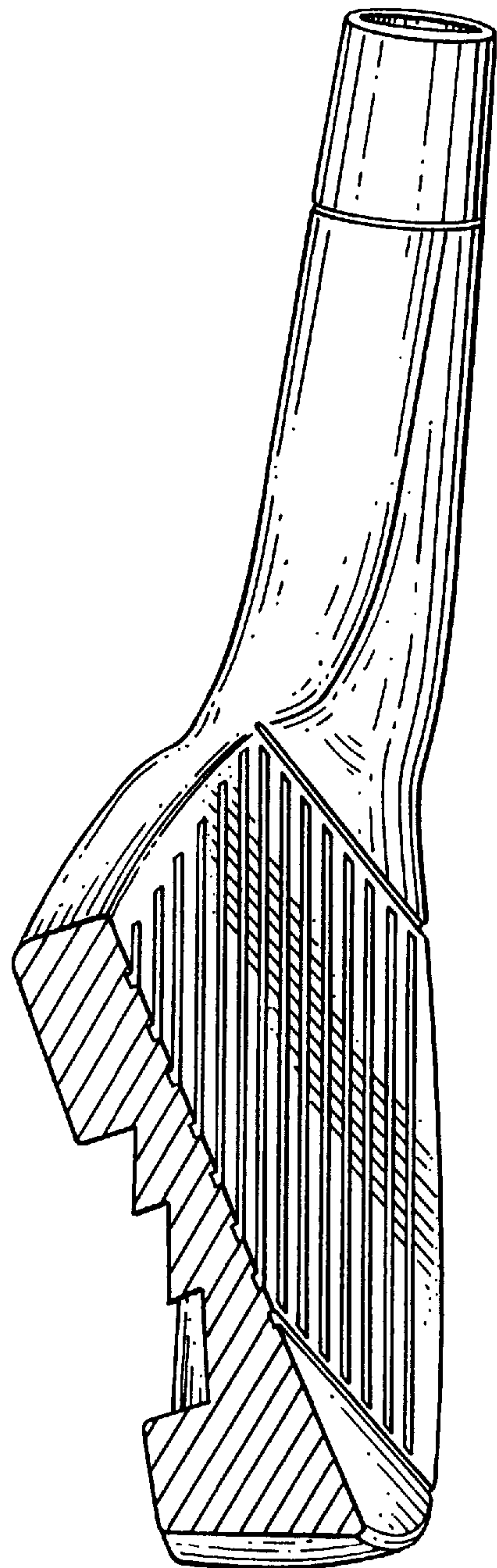

FIG. 13