

US00D406293S

United States Patent [19]
Mounfield, Jr.

[11] **Patent Number:** **Des. 406,293**
[45] **Date of Patent:** ****Mar. 2, 1999**

[54] **GOLF PUTTER HEAD**

[75] Inventor: **William Pratt Mounfield, Jr.,**
Lexington, S.C.

[73] Assignee: **M&M Technologies, Inc.,** Lexington,
S.C.

[**] Term: **14 Years**

[21] Appl. No.: **79,931**

[22] Filed: **Nov. 24, 1997**

Related U.S. Application Data

[63] Continuation-in-part of Ser. No. 66,302, Feb. 11, 1997.

[51] **LOC (6) Cl.** **21-02**

[52] **U.S. Cl.** **D21/744**

[58] **Field of Search** D21/217-219;
473/324, 327, 328, 340, 341, 251-256;
D25/119

[56] **References Cited**

U.S. PATENT DOCUMENTS

D. 225,118	11/1972	Susilovich	D21/217
D. 246,541	11/1977	Myers	D21/217
D. 351,443	10/1994	Caugh et al.	D21/219
D. 367,305	2/1996	Myers	D21/217
5,340,106	8/1994	Revaris	473/340 X

Primary Examiner—Mitchell I Siegel

[57] **CLAIM**

The ornamental design for a golf putter head, as shown and described.

DESCRIPTION

FIG. 1 is a top view of a golf putter head of our design;
FIG. 2 is a front view thereof;
FIG. 3 is a right side view thereof;
FIG. 4 is a perspective view thereof;
FIG. 5 is a bottom view thereof;
FIG. 6 is a top view of a second embodiment of the golf
putter head as disclosed in FIG. 1;
FIG. 7 is a front view thereof;

FIG. 8 is a right side view thereof;
FIG. 9 is a perspective view thereof;
FIG. 10 is a bottom view thereof;
FIG. 11 is a top view of a third embodiment of the golf putter
head as disclosed in FIG. 1;
FIG. 12 is a front view thereof;
FIG. 13 is a right side view thereof;
FIG. 14 is a perspective view thereof;
FIG. 15 is a bottom view thereof;
FIG. 16 is a top view of a fourth embodiment of the golf
putter head as disclosed in FIG. 1;
FIG. 17 is a front view thereof;
FIG. 18 is a right side view thereof;
FIG. 19 is a perspective view thereof;
FIG. 20 is a bottom view thereof;
FIG. 21 is a top view of a fifth embodiment of the golf putter
head as disclosed in FIG. 1;
FIG. 22 is a front view thereof;
FIG. 23 is a right side view thereof;
FIG. 24 is a perspective view thereof;
FIG. 25 is a bottom view thereof;
FIG. 26 is a top view of a sixth embodiment of the golf
putter head as disclosed in FIG. 1;
FIG. 27 is a front view thereof;
FIG. 28 is a right side view thereof;
FIG. 29 is a perspective view thereof;
FIG. 30 is a bottom view thereof;
FIG. 31 is a top view of a seventh embodiment of the golf
putter head as disclosed in FIG. 1;
FIG. 32 is a front view thereof;
FIG. 33 is a right side view thereof;
FIG. 34 is a perspective view thereof;
FIG. 35 is a bottom view thereof;
FIG. 36 is a top view of a eighth embodiment of the golf
putter head as disclosed in FIG. 1;
FIG. 37 is a front view thereof;
FIG. 38 is a right side view thereof;
FIG. 39 is a perspective view thereof;
FIG. 40 is a bottom view thereof;
FIG. 41 is a top view of a tenth embodiment of the golf
putter head as disclosed in FIG. 1;
FIG. 42 is a front view thereof;
FIG. 43 is a right side view thereof;
FIG. 44 is a perspective view thereof;
FIG. 45 is a bottom view thereof;

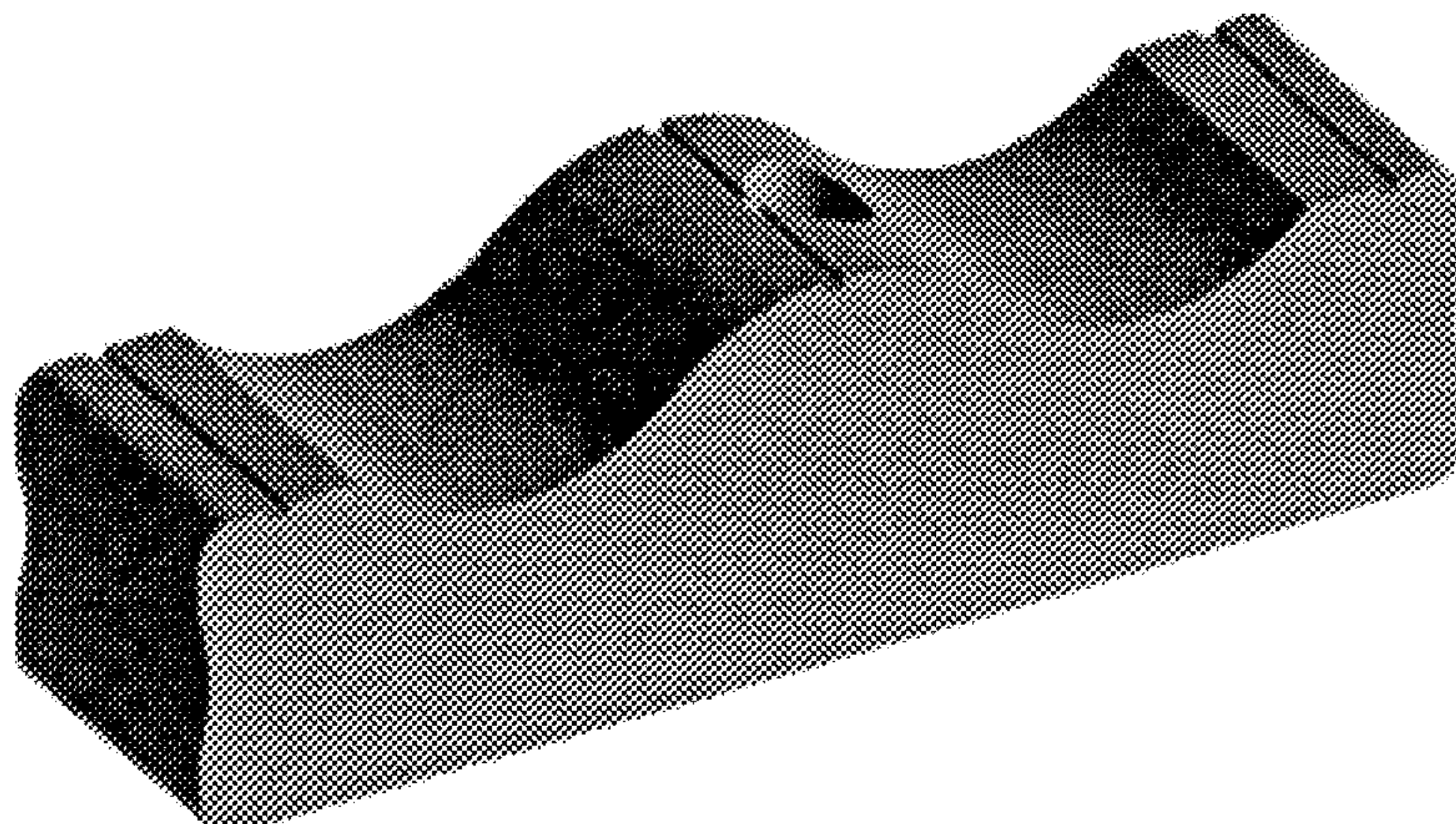

FIG. 46 is a top view of a tenth embodiment of the golf putter head as described in FIG. 1;
FIG. 47 is a front view thereof;
FIG. 48 is a right side view thereof;
FIG. 49 is a perspective view thereof;
FIG. 50 is a bottom view thereof;
FIG. 51 is a top view of a eleventh embodiment of the golf putter head as disclosed in FIG. 1;
FIG. 52 is a front view thereof;
FIG. 53 is a right side view thereof;
FIG. 54 is a perspective view thereof;
FIG. 55 is a bottom view thereof;
FIG. 56 is a top view of a twelfth embodiment of the golf putter head as disclosed in FIG. 1;
FIG. 57 is a front view thereof;
FIG. 58 is a right side view thereof;
FIG. 59 is a perspective view thereof;
FIG. 60 is a bottom view thereof;
FIG. 61 is a top view of a thirteenth embodiment of the golf putter head as disclosed in FIG. 1;
FIG. 62 is a front view thereof;
FIG. 63 is a right side view thereof;
FIG. 64 is a perspective view thereof;
FIG. 65 is a bottom view thereof;
FIG. 66 is a top view of a fourteenth embodiment of the golf putter head as disclosed in FIG. 1;
FIG. 67 is a front view thereof;
FIG. 68 is a right side view thereof;
FIG. 69 is a perspective view thereof;
FIG. 70 is a bottom view thereof;
FIG. 71 is a top view of a fifteenth embodiment of the golf putter head as disclosed in FIG. 1;
FIG. 72 is a front view thereof;
FIG. 73 is a right side view thereof;
FIG. 74 is a perspective view thereof;
FIG. 75 is a bottom view thereof;
FIG. 76 is a top view of a sixteenth embodiment of the golf putter head as disclosed in FIG. 1;
FIG. 77 is a front view thereof;
FIG. 78 is a right side view thereof;
FIG. 79 is a perspective view thereof;
FIG. 80 is a bottom view thereof;
FIG. 81 is a top view of a seventeenth embodiment of the golf putter head as disclosed in FIG. 1;
FIG. 82 is a front view thereof;
FIG. 83 is a right side view thereof;
FIG. 84 is a perspective view thereof;
FIG. 85 is a bottom view thereof;
FIG. 86 is a top view of a eighteenth embodiment of the golf putter head as disclosed in FIG. 1;
FIG. 87 is a front view thereof;
FIG. 88 is a right side view thereof;
FIG. 89 is a perspective view thereof;
FIG. 90 is a bottom view thereof;
FIG. 91 is a top view of a nineteenth embodiment of the golf putter head as disclosed in FIG. 1;
FIG. 92 is a front view thereof;
FIG. 93 is a right side view thereof;
FIG. 94 is a perspective view thereof;
FIG. 95 is a bottom view thereof;
FIG. 96 is a top view of a twentieth embodiment of the golf putter head as disclosed in FIG. 1;
FIG. 97 is a front view thereof;
FIG. 98 is a right side view thereof;
FIG. 99 is a perspective view thereof;
FIG. 100 is a bottom view thereof;
FIG. 101 is a top view of a twenty first embodiment of the golf putter head as disclosed in FIG. 1;
FIG. 102 is a front view thereof;
FIG. 103 is a right side view thereof;
FIG. 104 is a perspective view thereof;
FIG. 105 is a bottom view thereof;
FIG. 106 is a top view of a twenty second embodiment of the golf putter head as disclosed in FIG. 1;
FIG. 107 is a front view thereof;
FIG. 108 is a right side view thereof;
FIG. 109 is a perspective view thereof;
FIG. 110 is a bottom view thereof;
FIG. 111 is a top view of a twenty third embodiment of the golf putter head as disclosed in FIG. 1;
FIG. 112 is a front view thereof;
FIG. 113 is a right side view thereof;
FIG. 114 is a perspective view thereof;
FIG. 115 is a bottom view thereof;
FIG. 116 is a top view of a twenty fourth embodiment of the golf putter head as disclosed in FIG. 1;
FIG. 117 is a front view thereof;
FIG. 118 is a right side view thereof;
FIG. 119 is a perspective view thereof;
FIG. 120 is a bottom view thereof;
FIG. 121 is a top view of a twenty fifth embodiment of the golf putter head as disclosed in FIG. 1;
FIG. 122 is a front view thereof;
FIG. 123 is a right side view thereof;
FIG. 124 is a perspective view thereof;
FIG. 125 is a bottom view thereof;
FIG. 126 is a top view of a twenty sixth embodiment of the golf putter head as disclosed in FIG. 1;
FIG. 127 is a front view thereof;
FIG. 128 is a right side view thereof;
FIG. 129 is a perspective view thereof;
FIG. 130 is a bottom view thereof;
FIG. 131 is a top view of a twenty seventh embodiment of the golf putter head as disclosed in FIG. 1;
FIG. 132 is a front view thereof;
FIG. 133 is a right side view thereof;
FIG. 134 is a perspective view thereof; and,
FIG. 135 is a bottom view thereof.

1 Claim, 27 Drawing Sheets

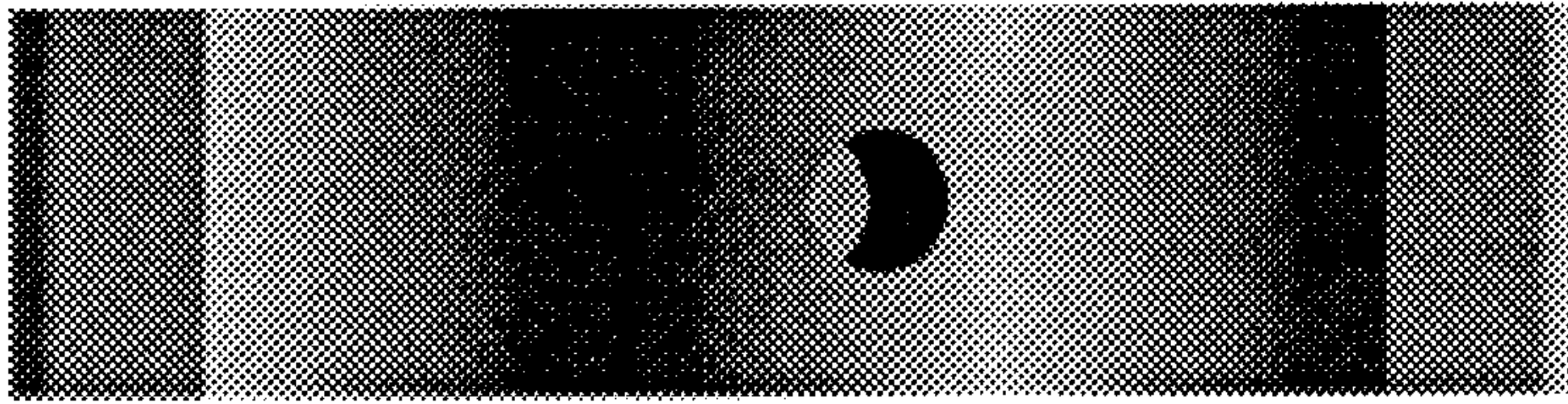

Fig. 1

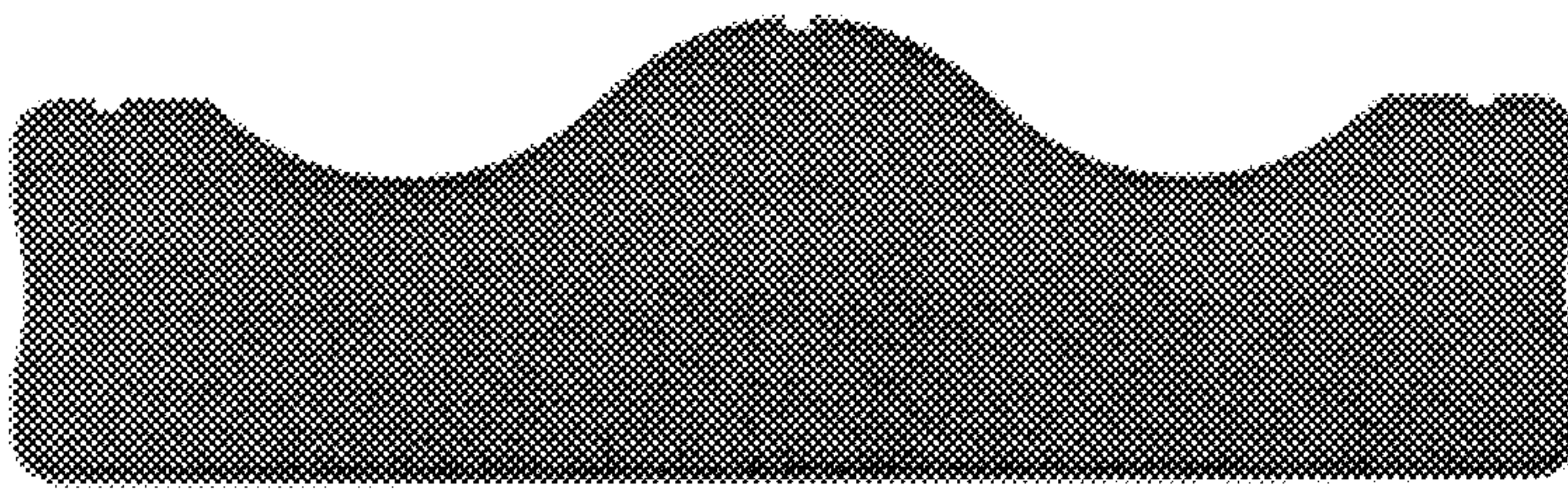

Fig. 2

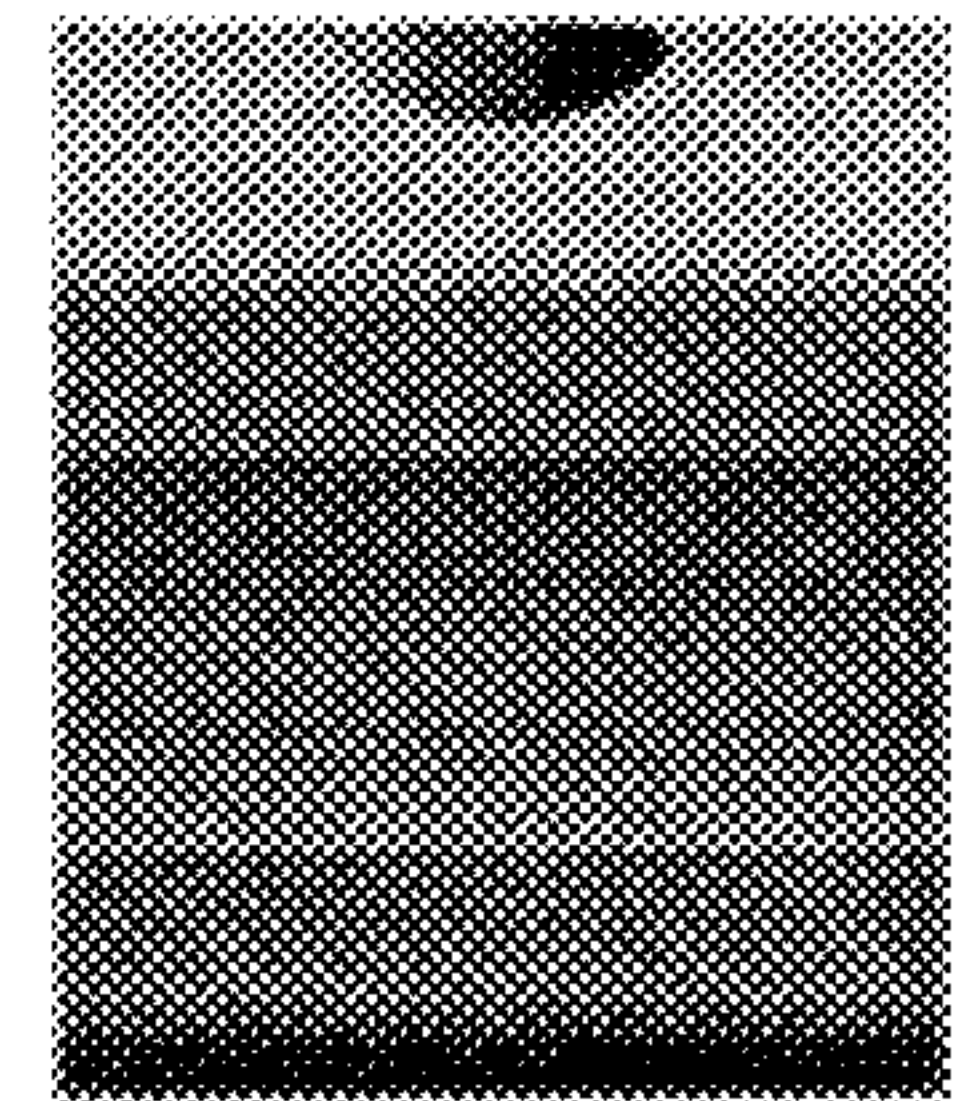

Fig. 3

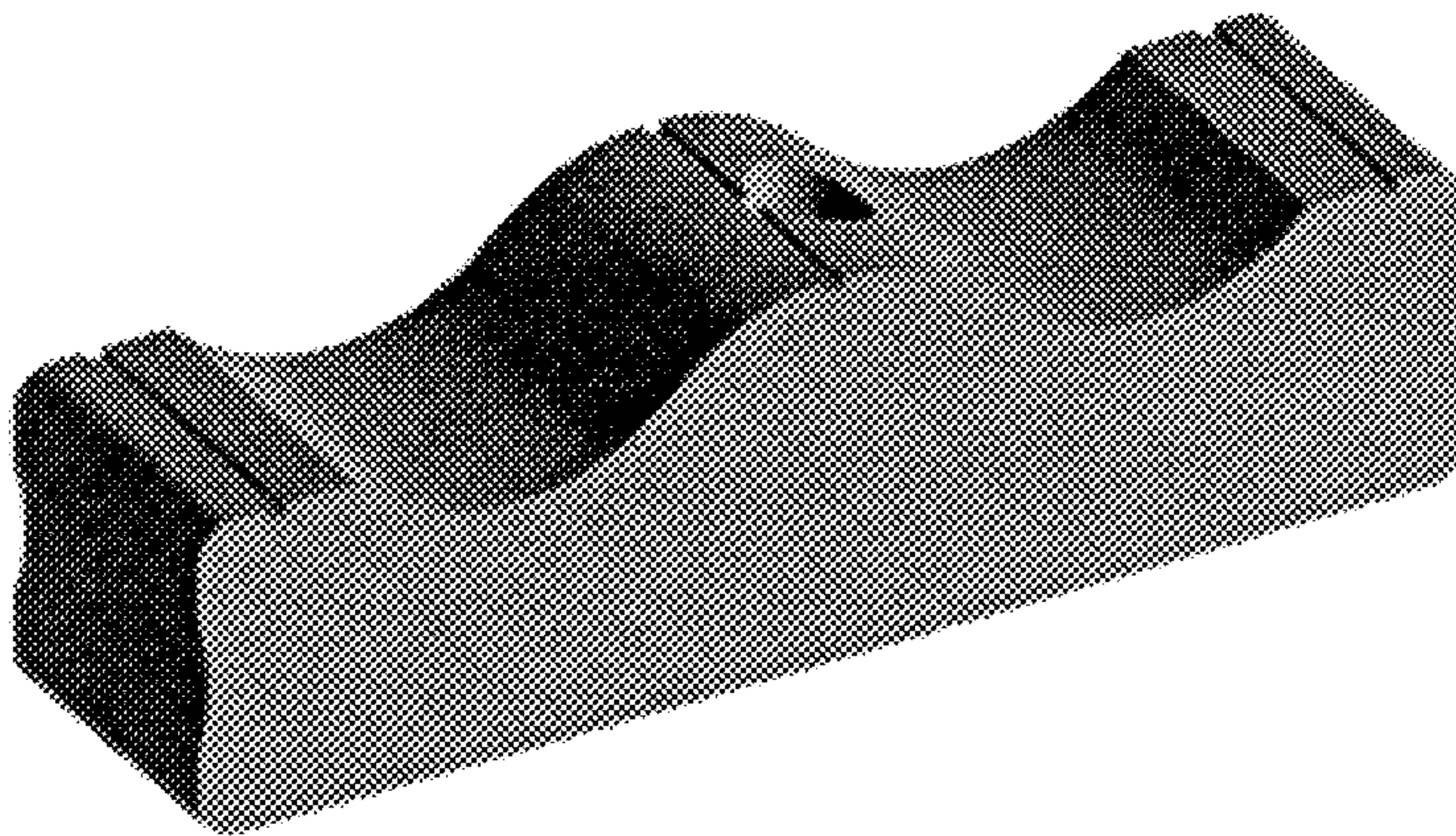

Fig. 4

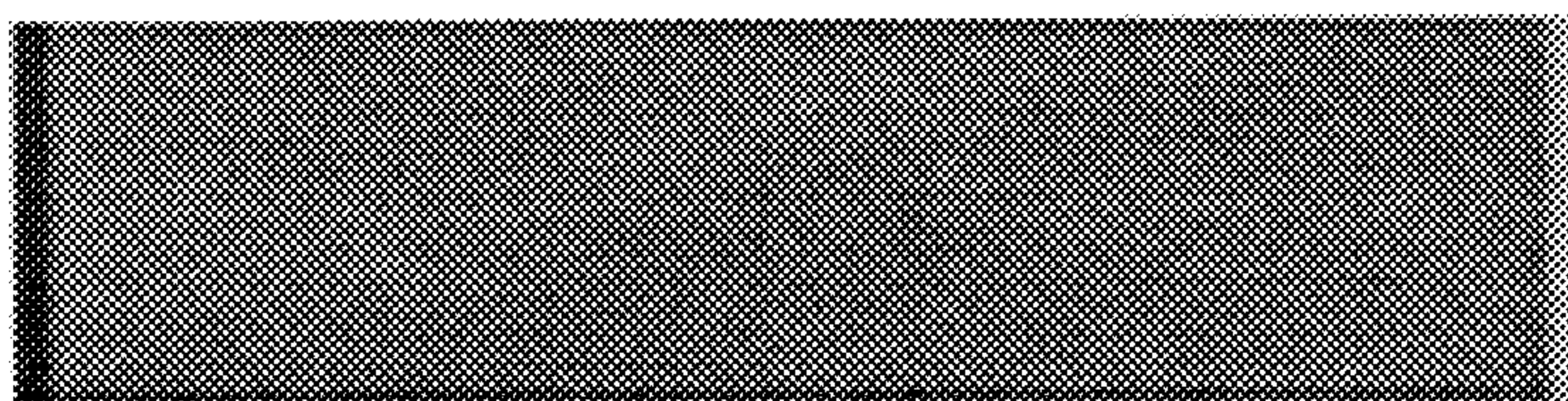

Fig. 5

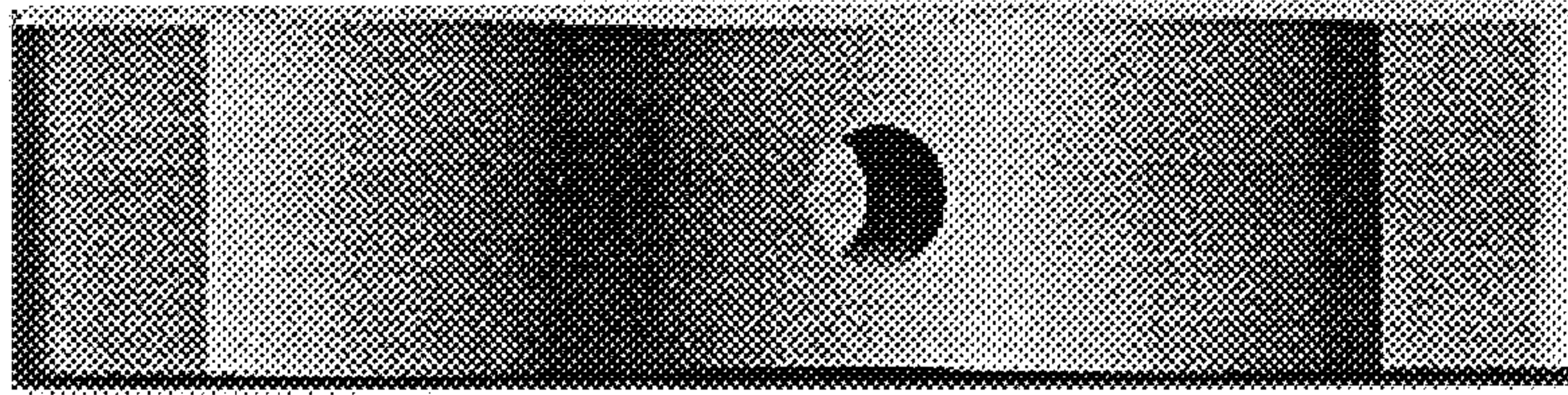

Fig. 6

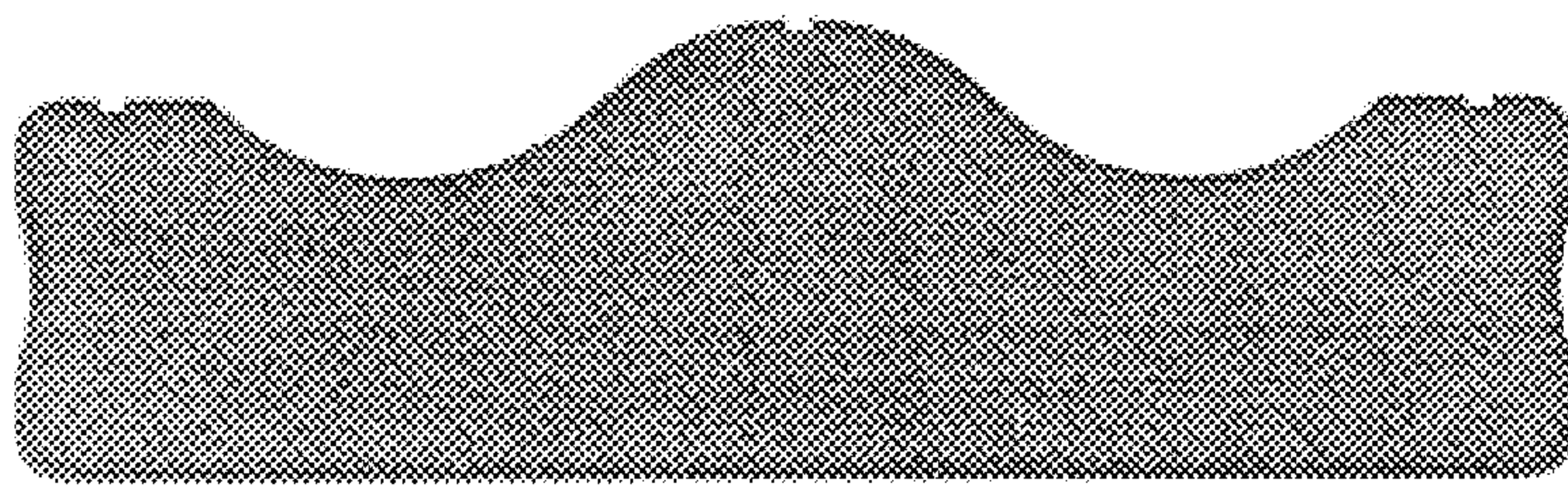

Fig. 7

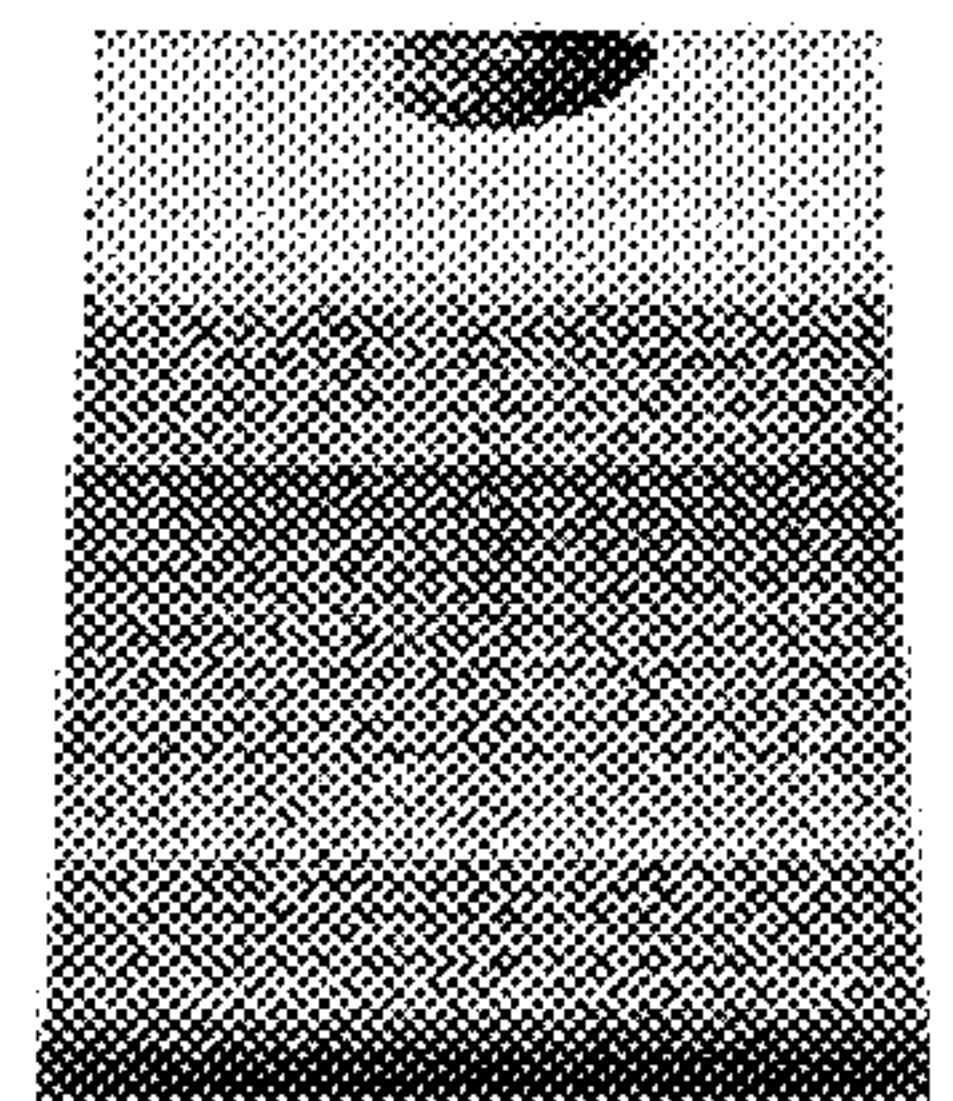

Fig. 8

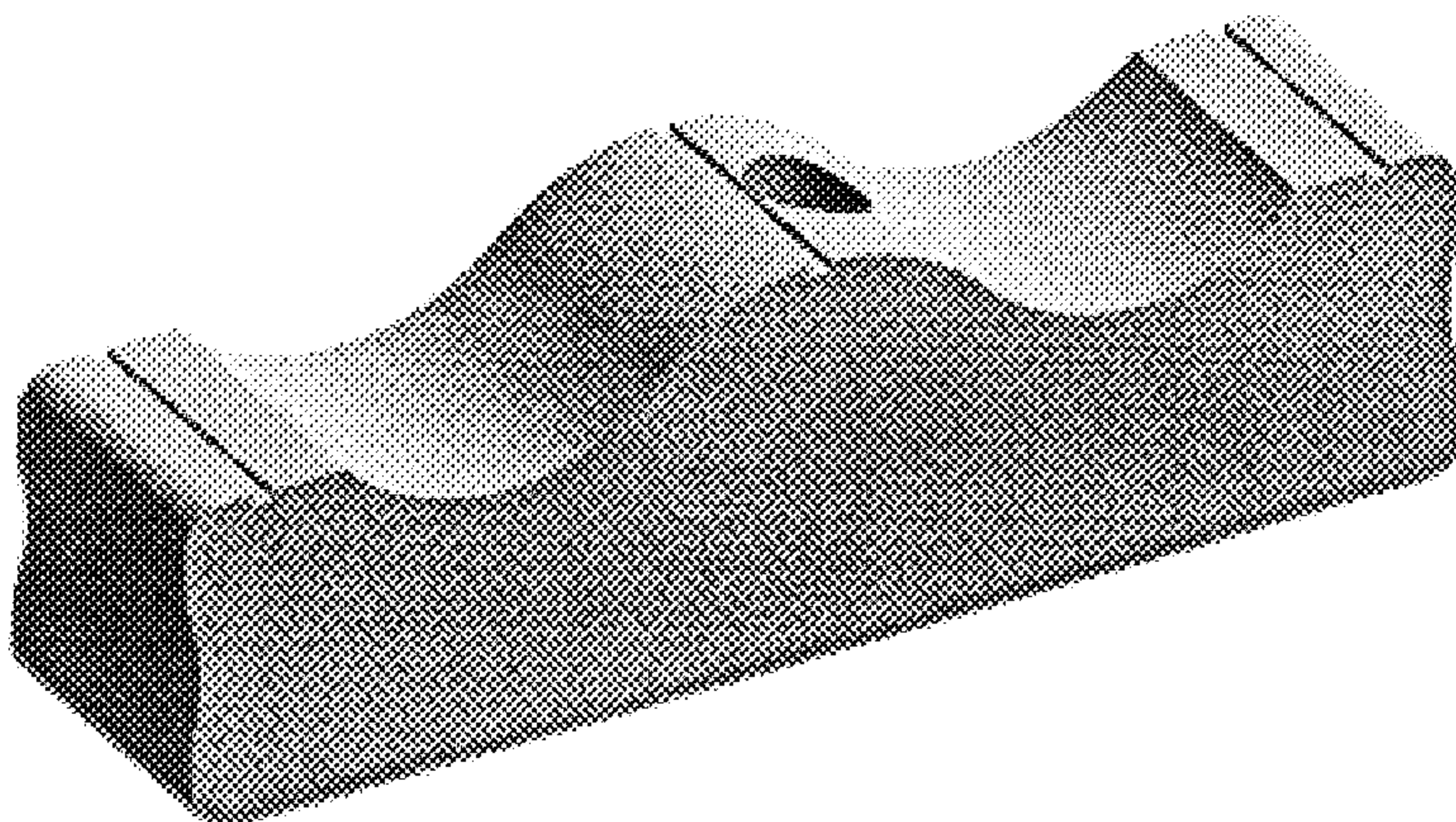

Fig. 9

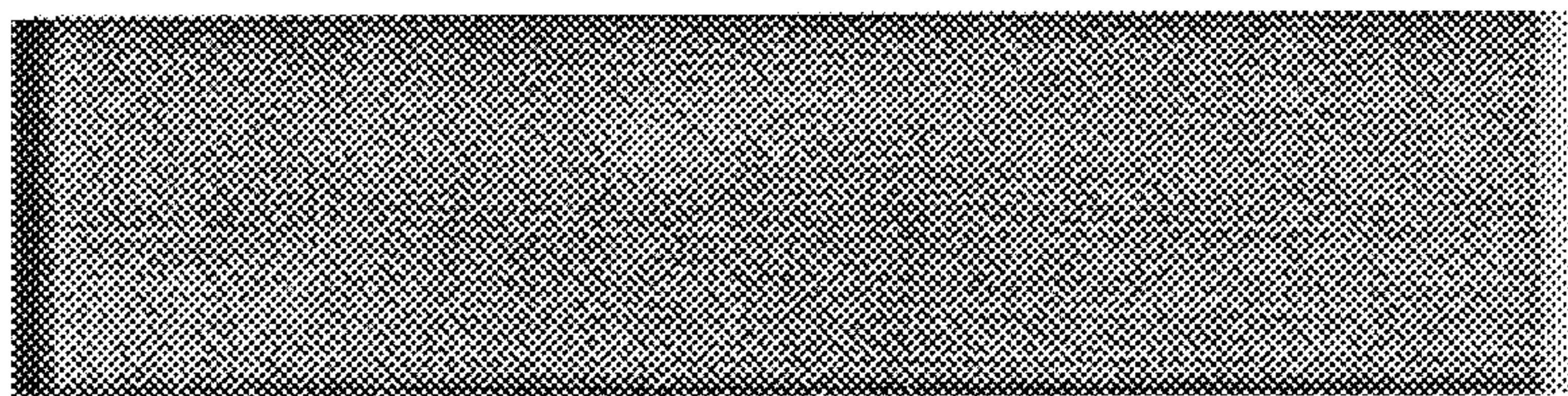

Fig. 10

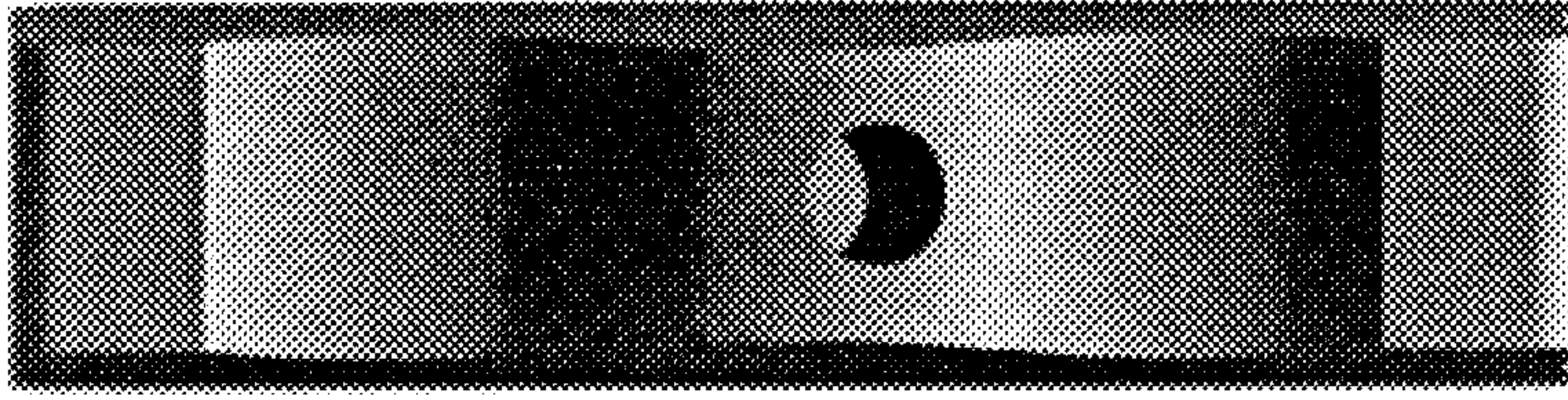

Fig. 11

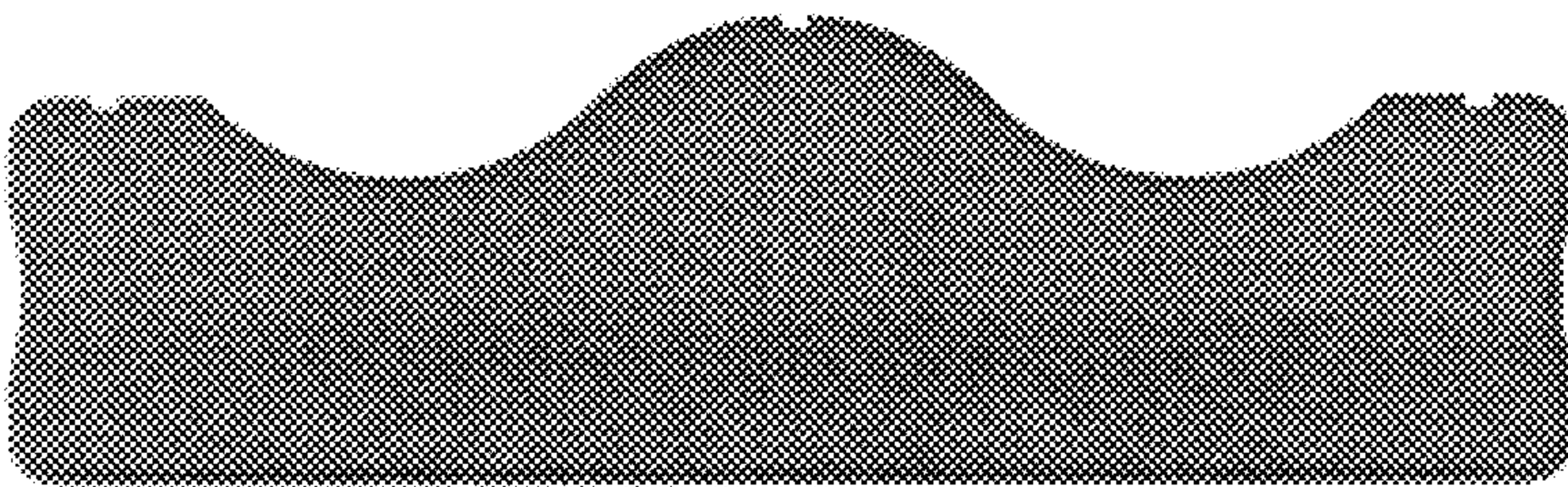

Fig. 12

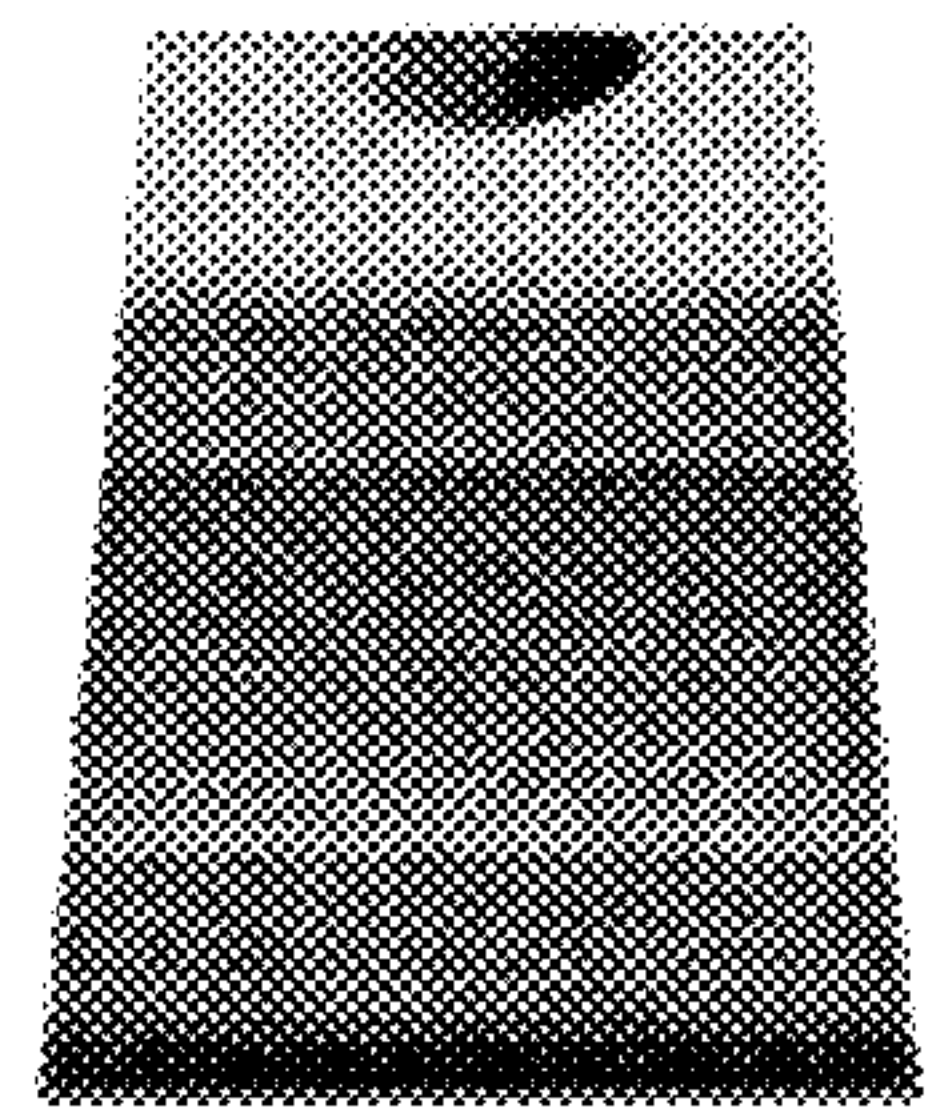

Fig. 13

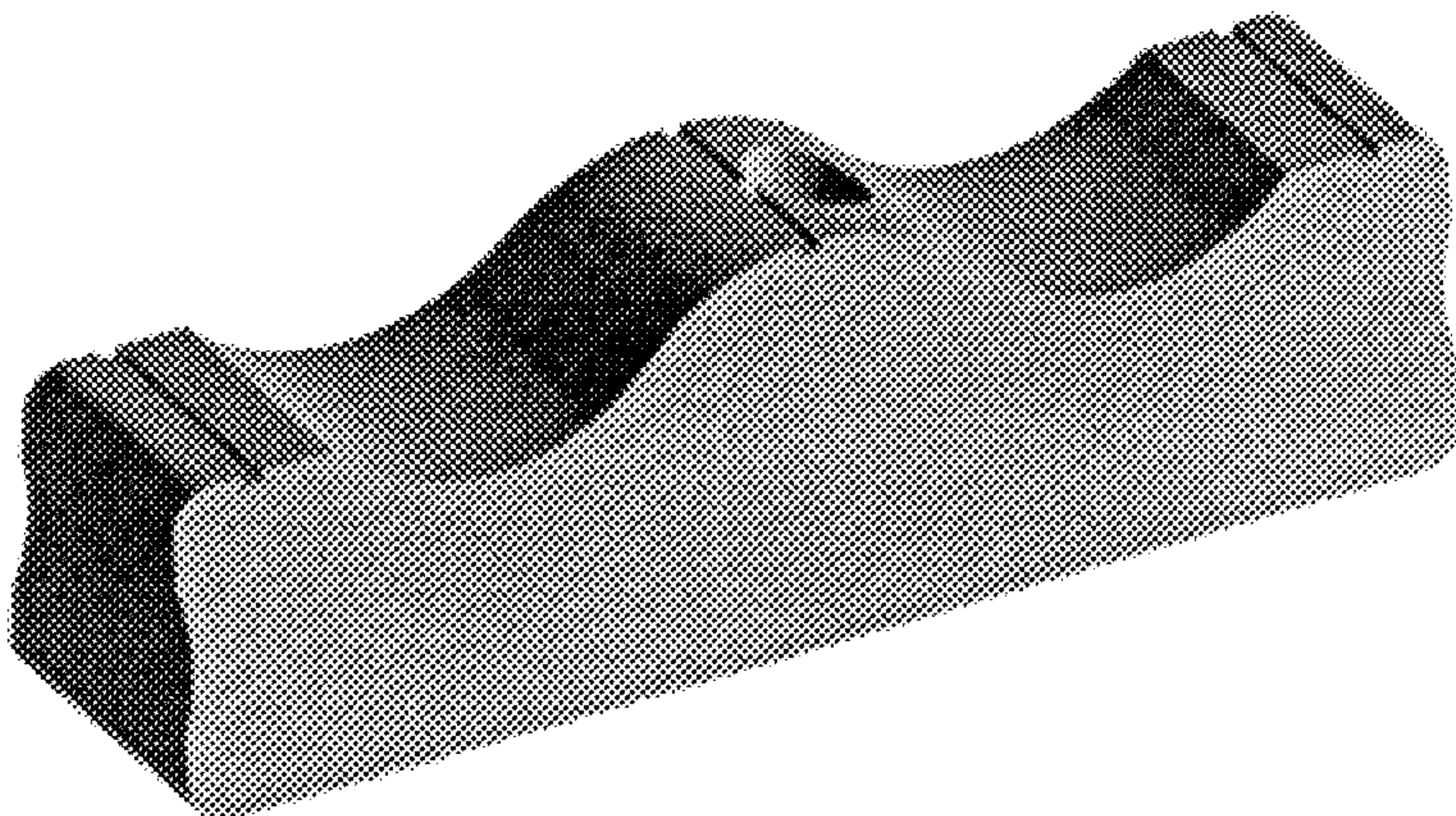

Fig. 14

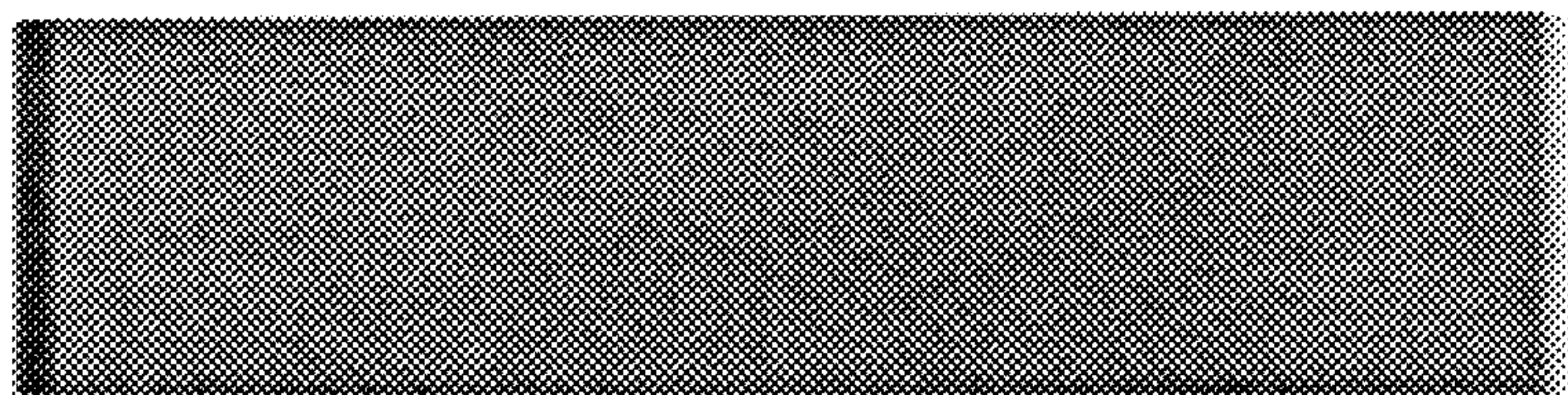

Fig. 15

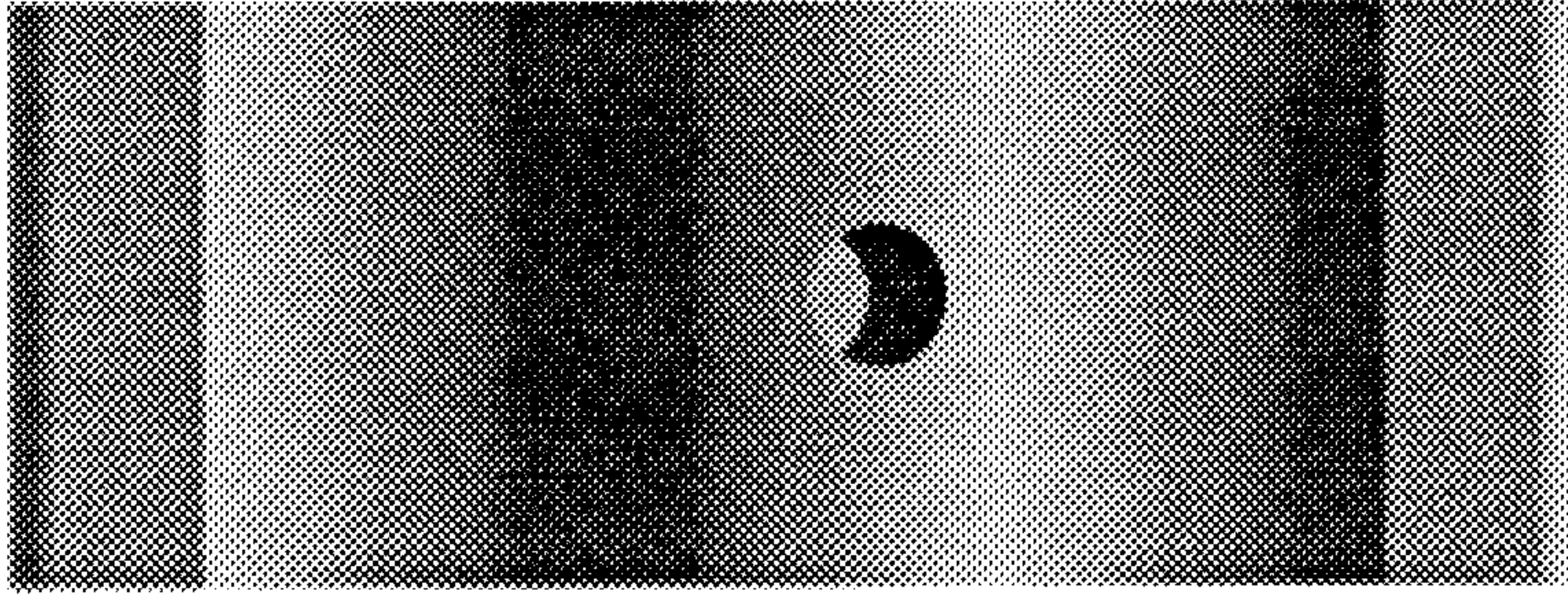

Fig. 16

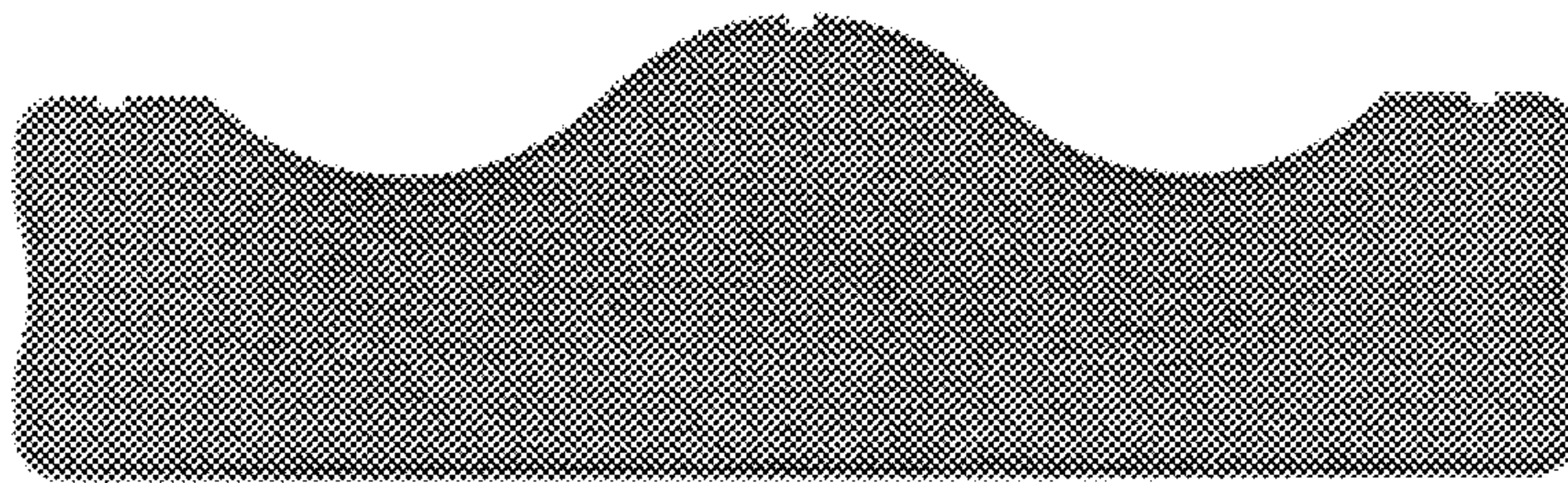

Fig. 17

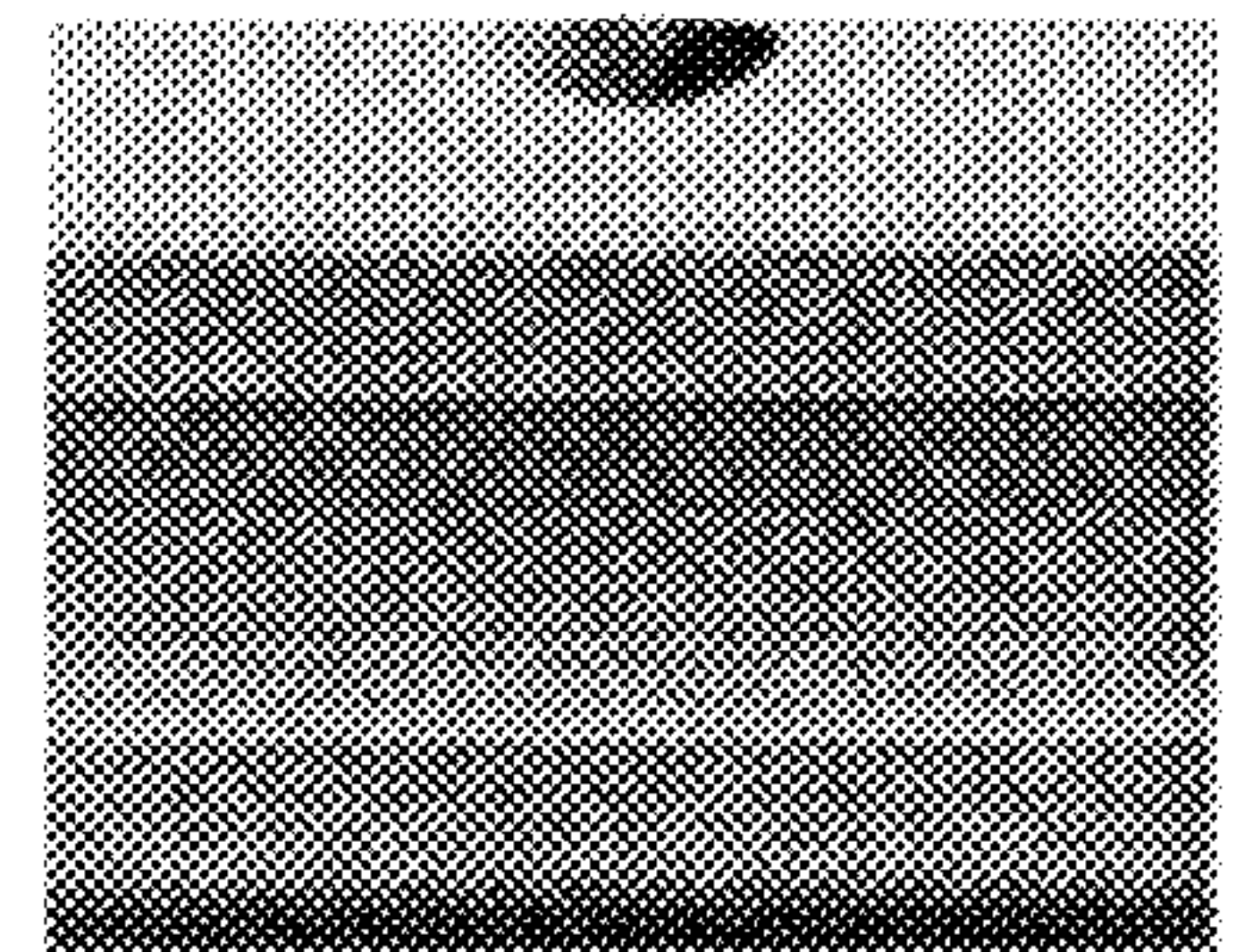

Fig. 18

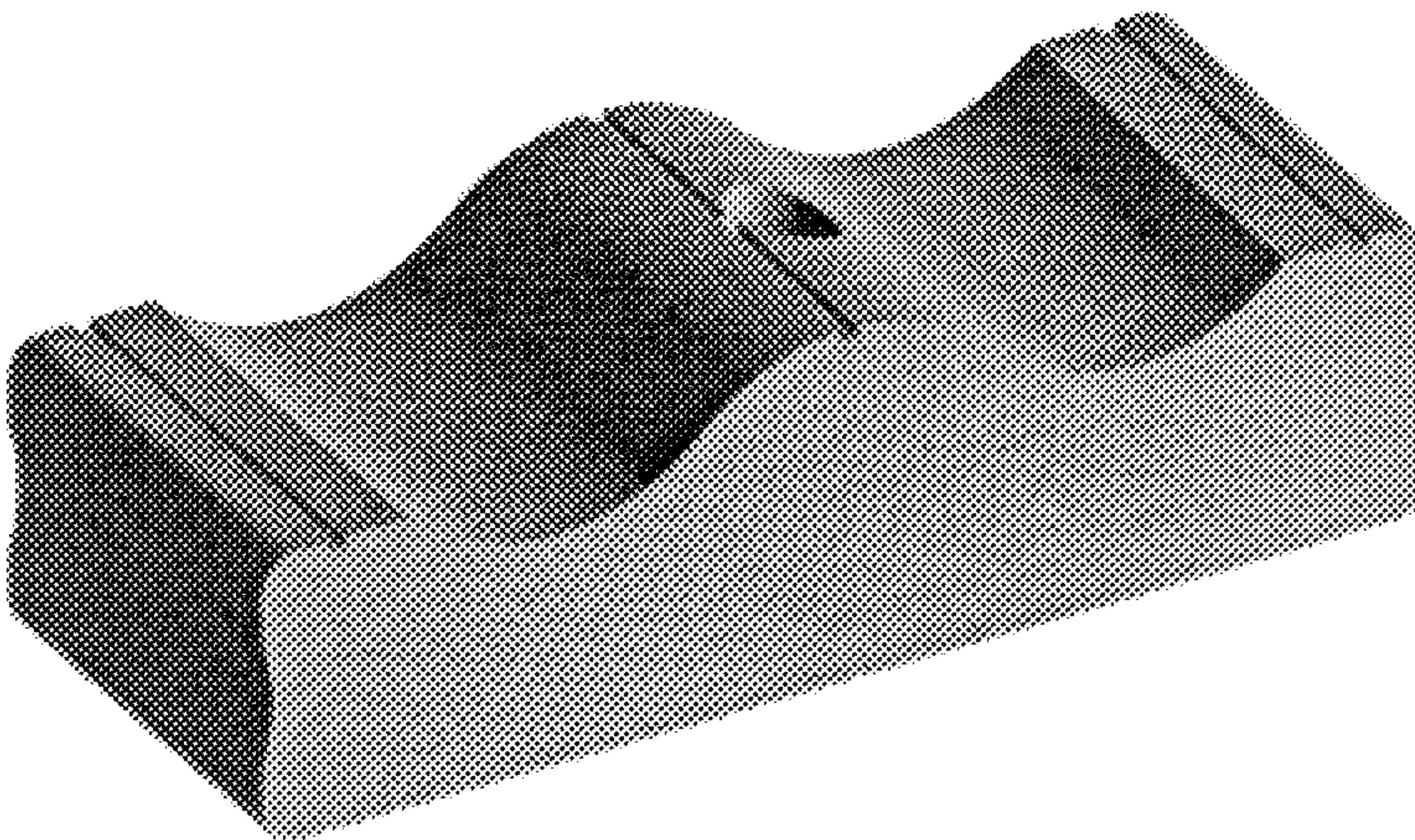

Fig. 19

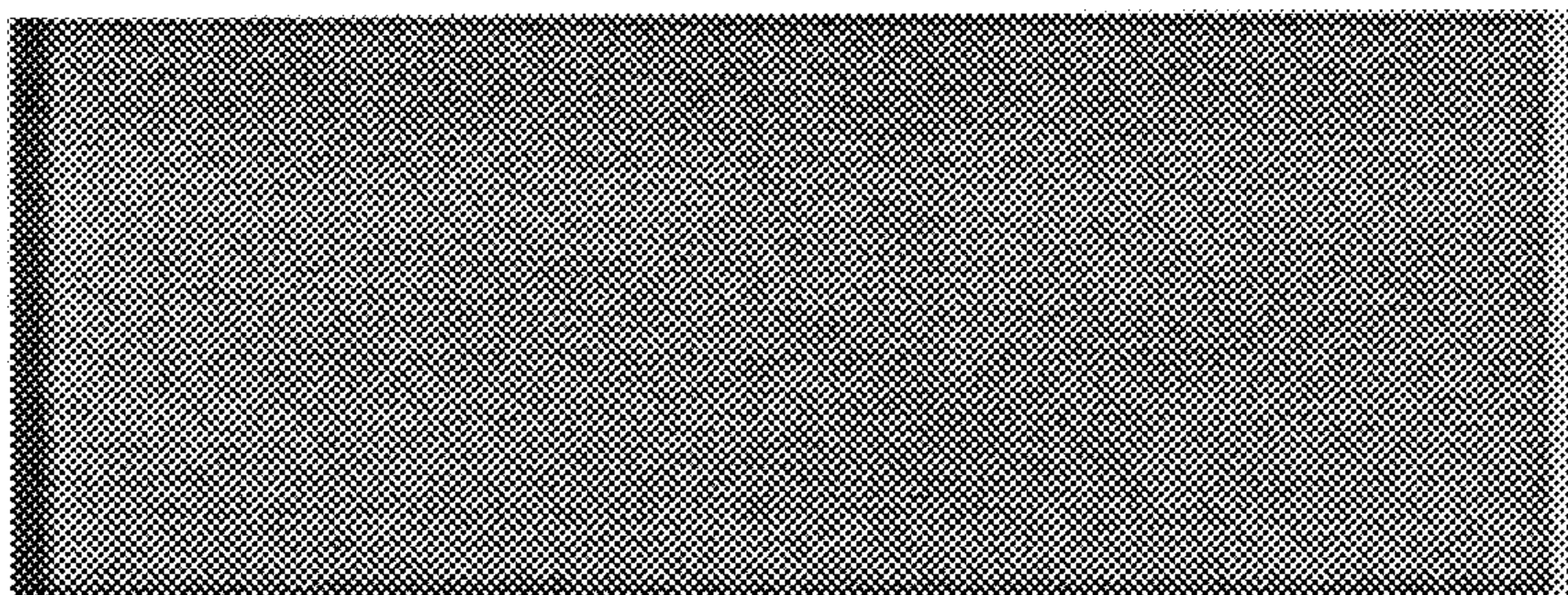

Fig. 20

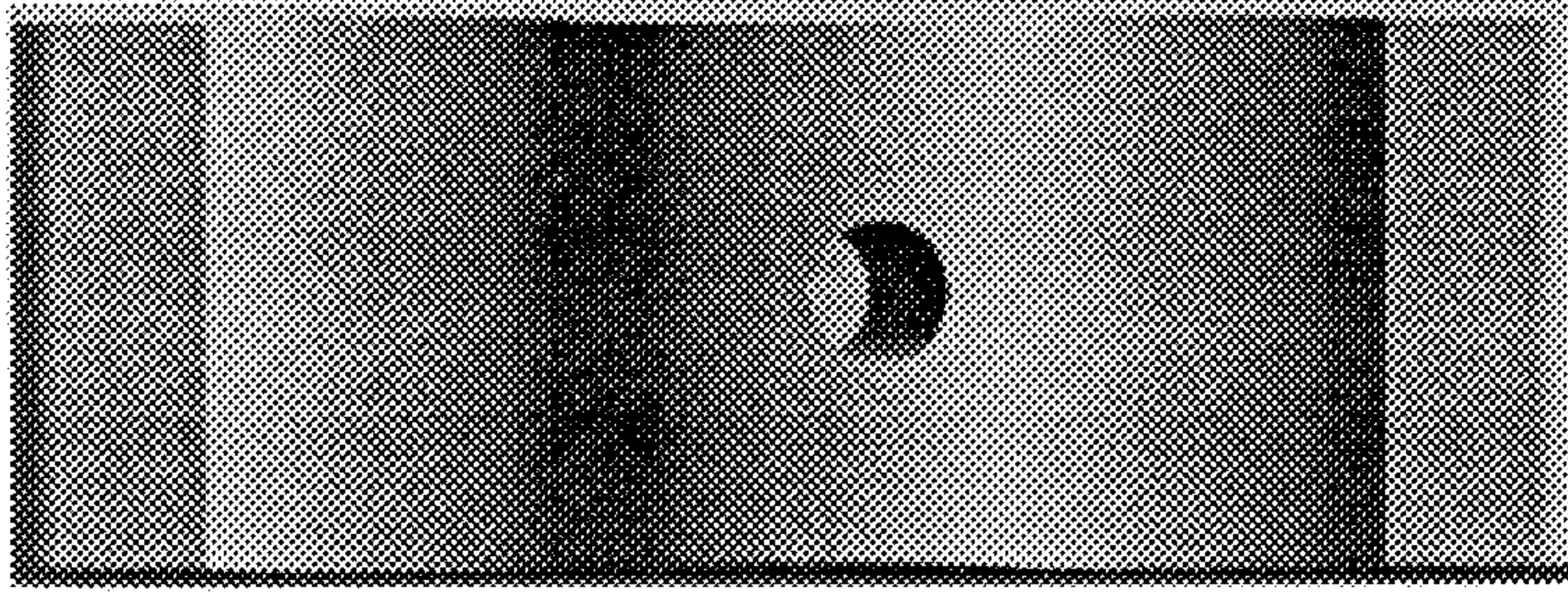

Fig. 21

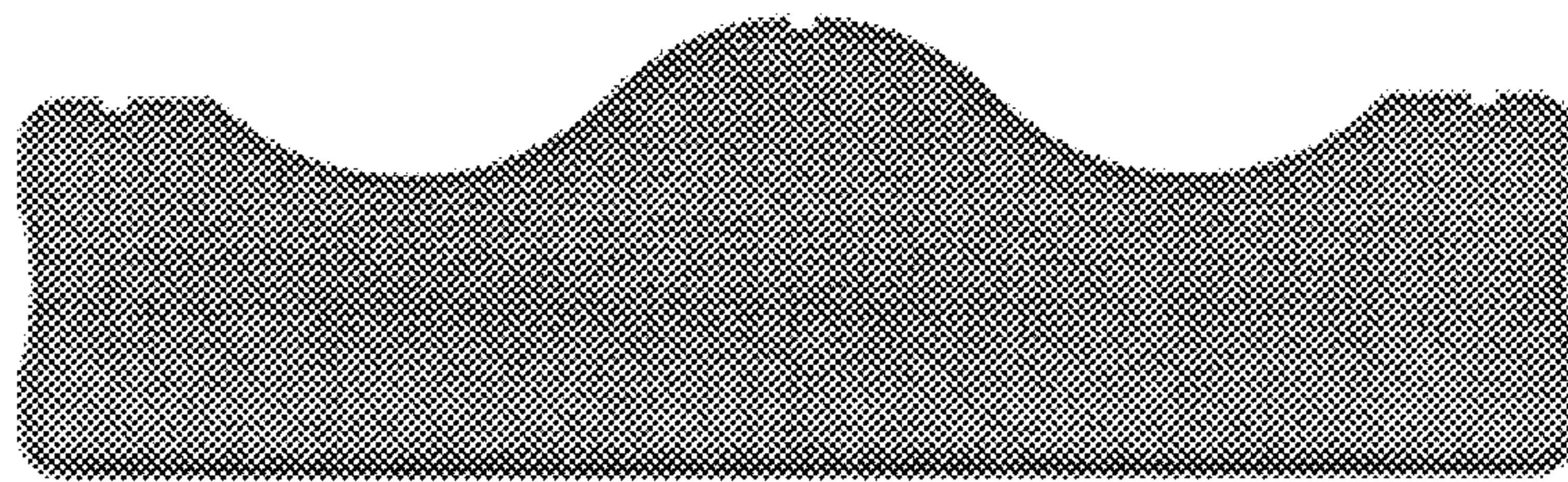

Fig. 22

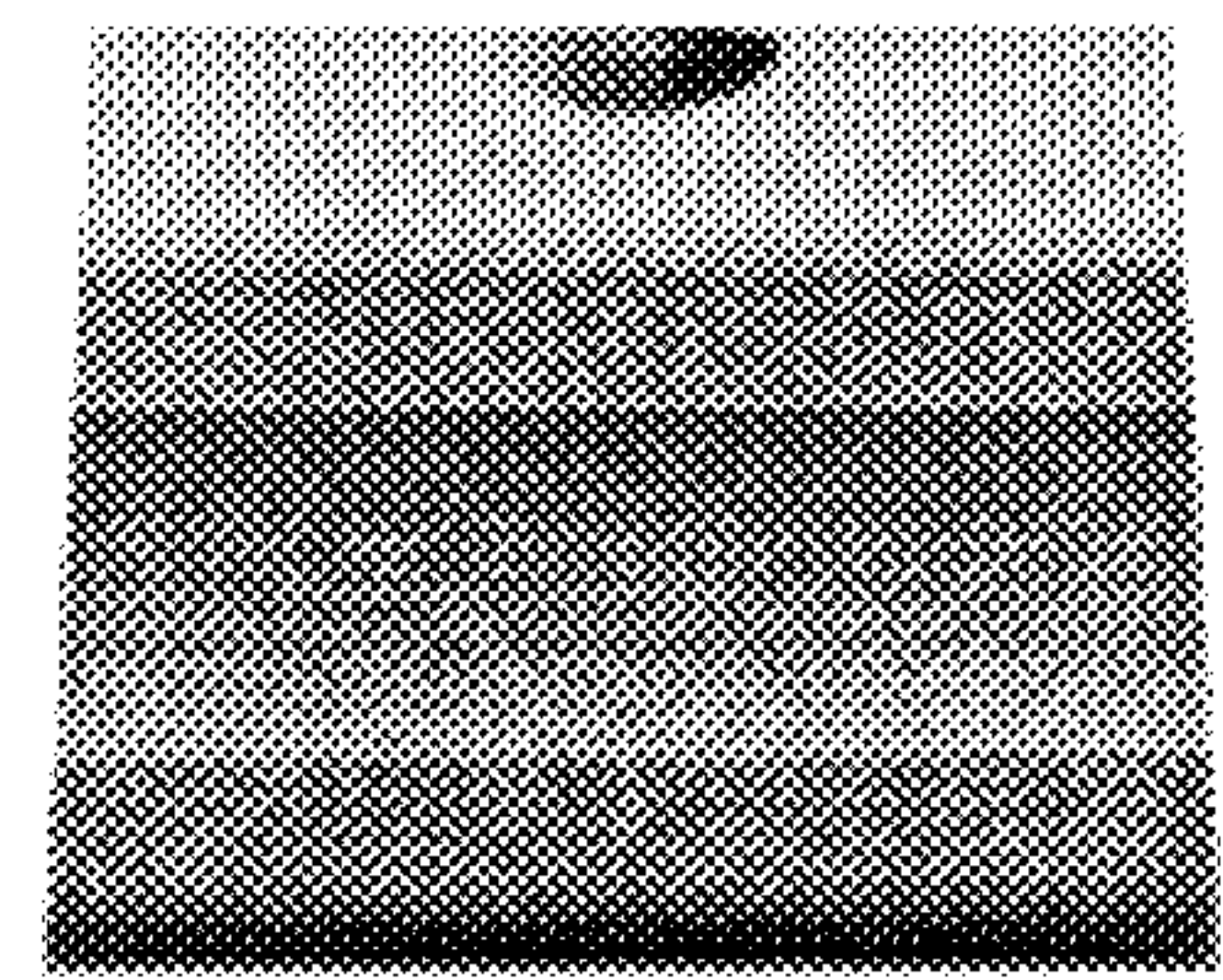

Fig. 23

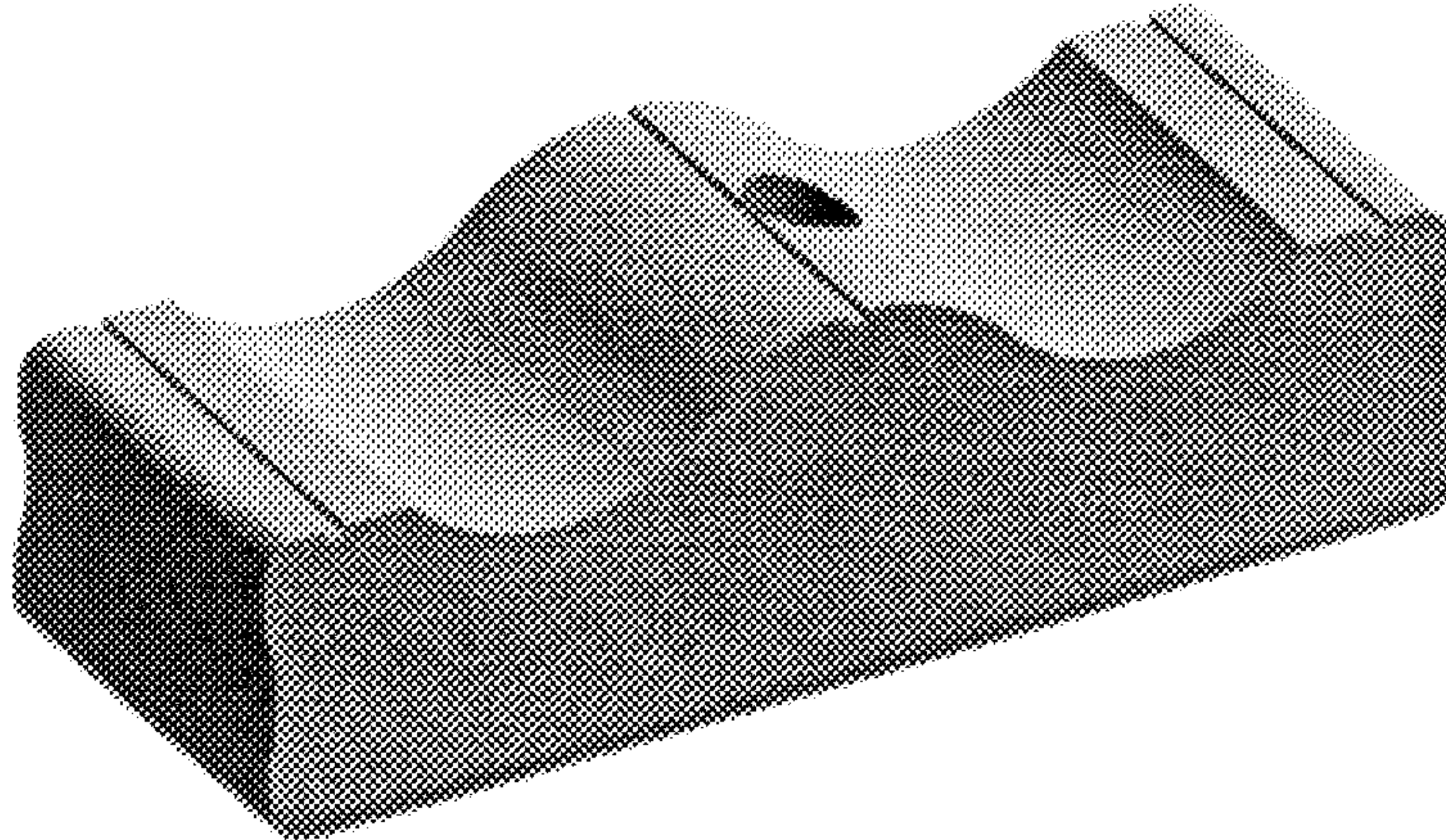

Fig. 24

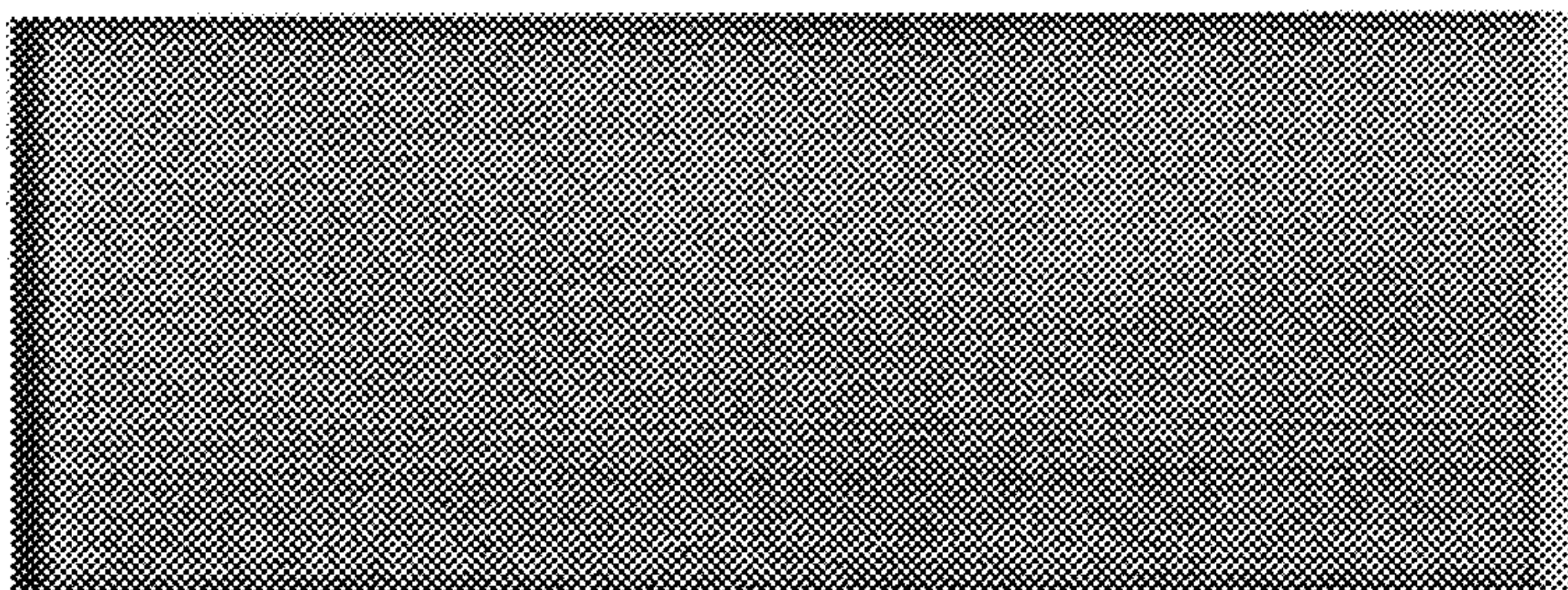

Fig. 25

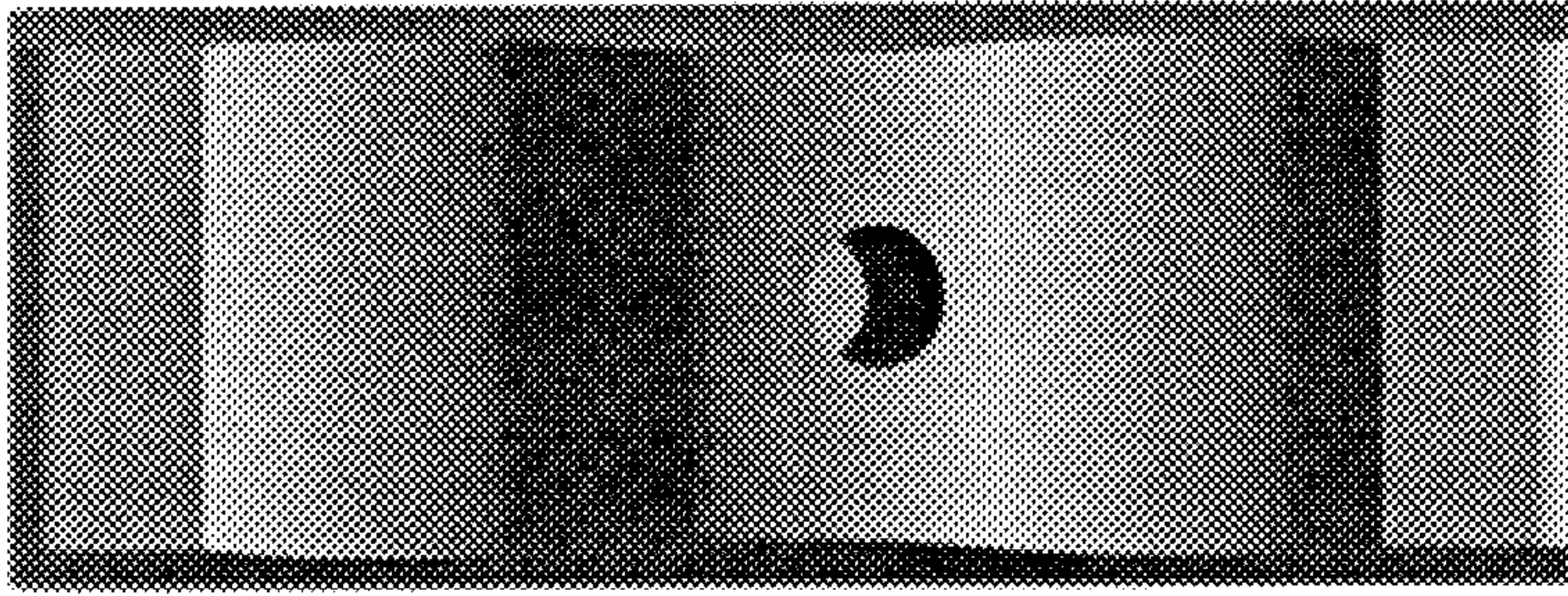

Fig. 26

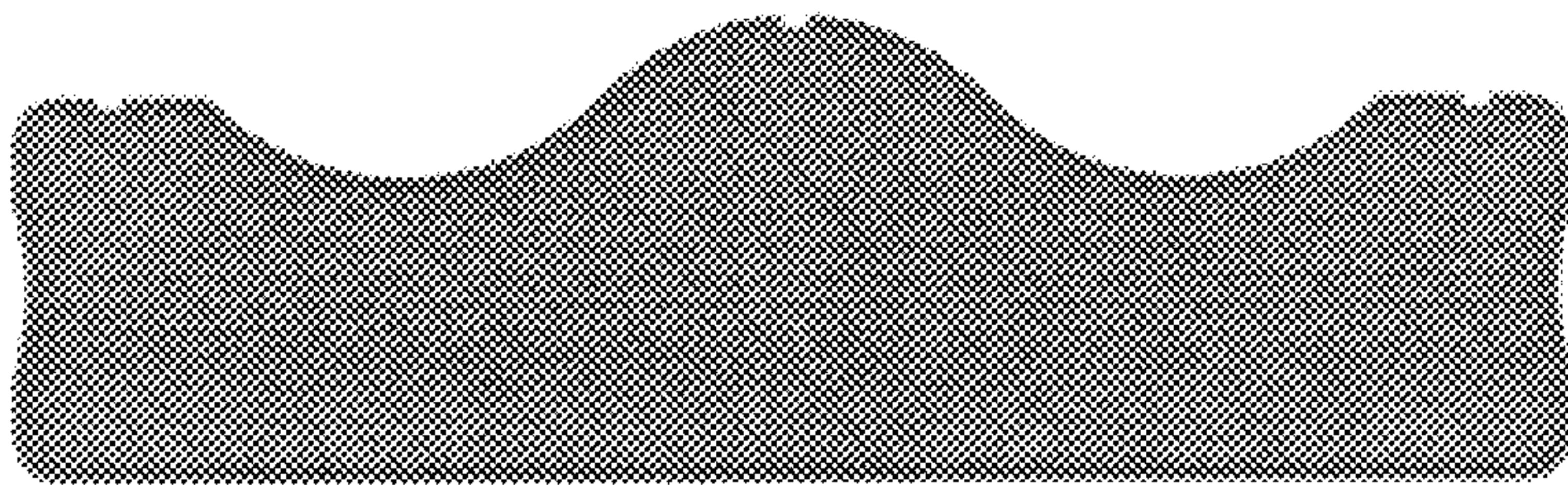

Fig. 27

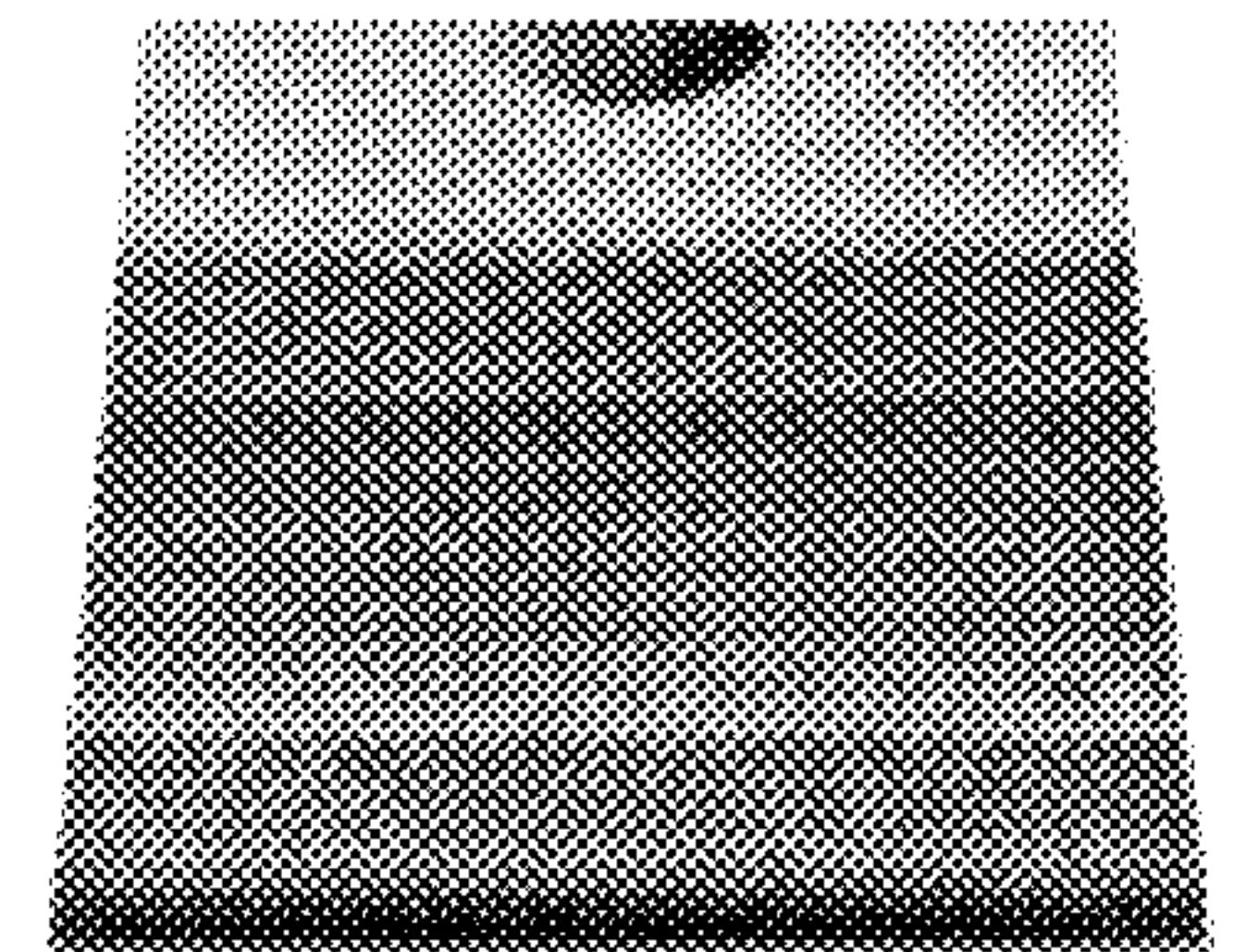

Fig. 28

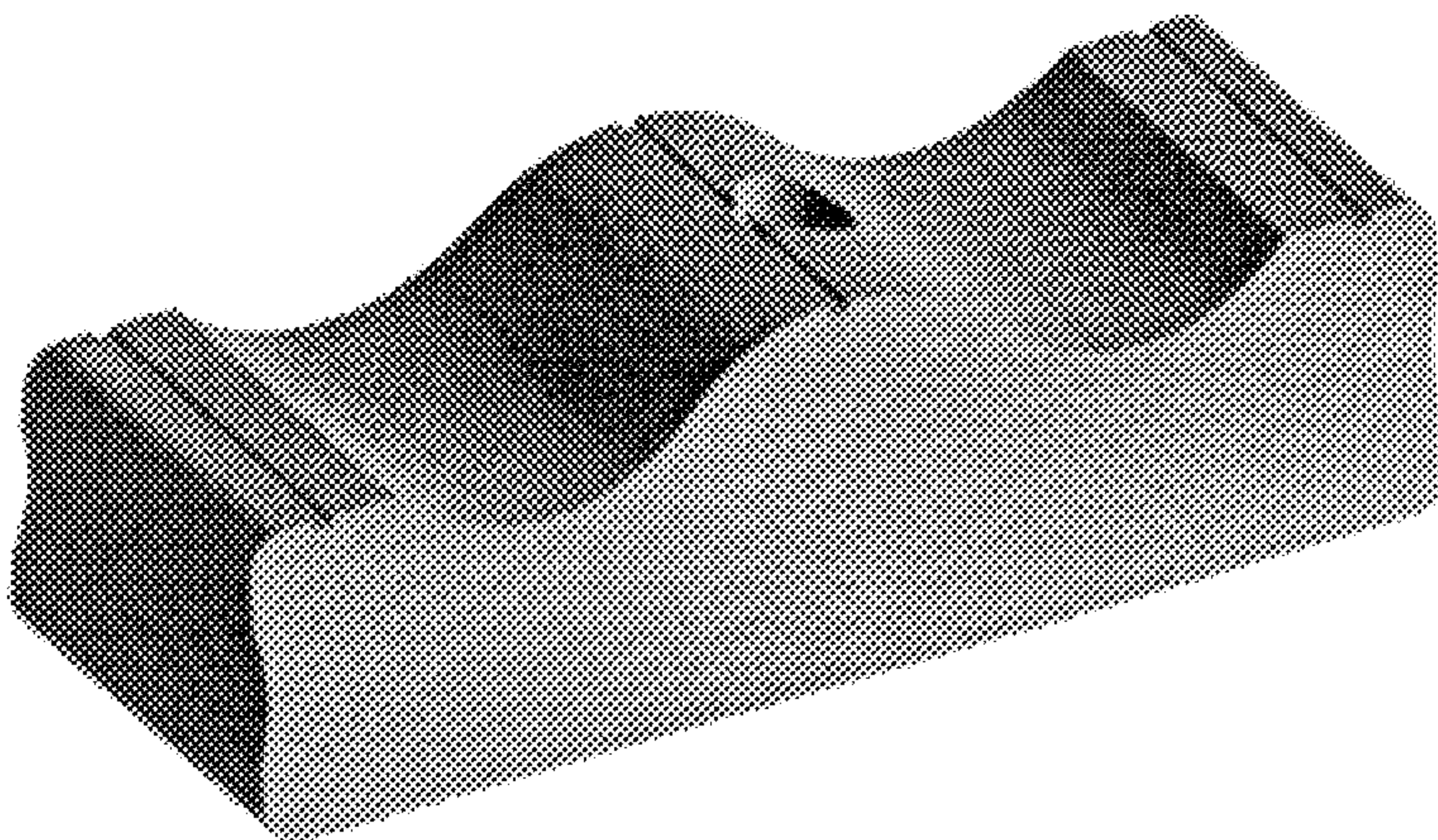

Fig. 29

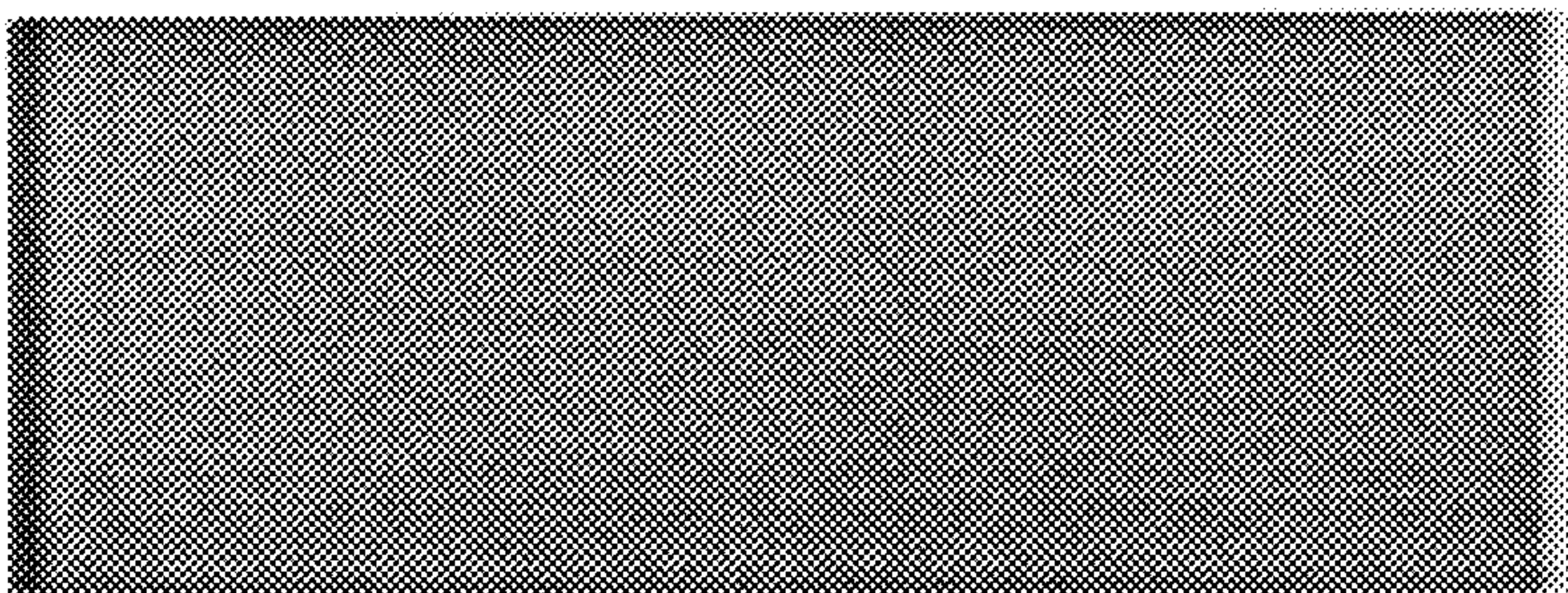

Fig. 30

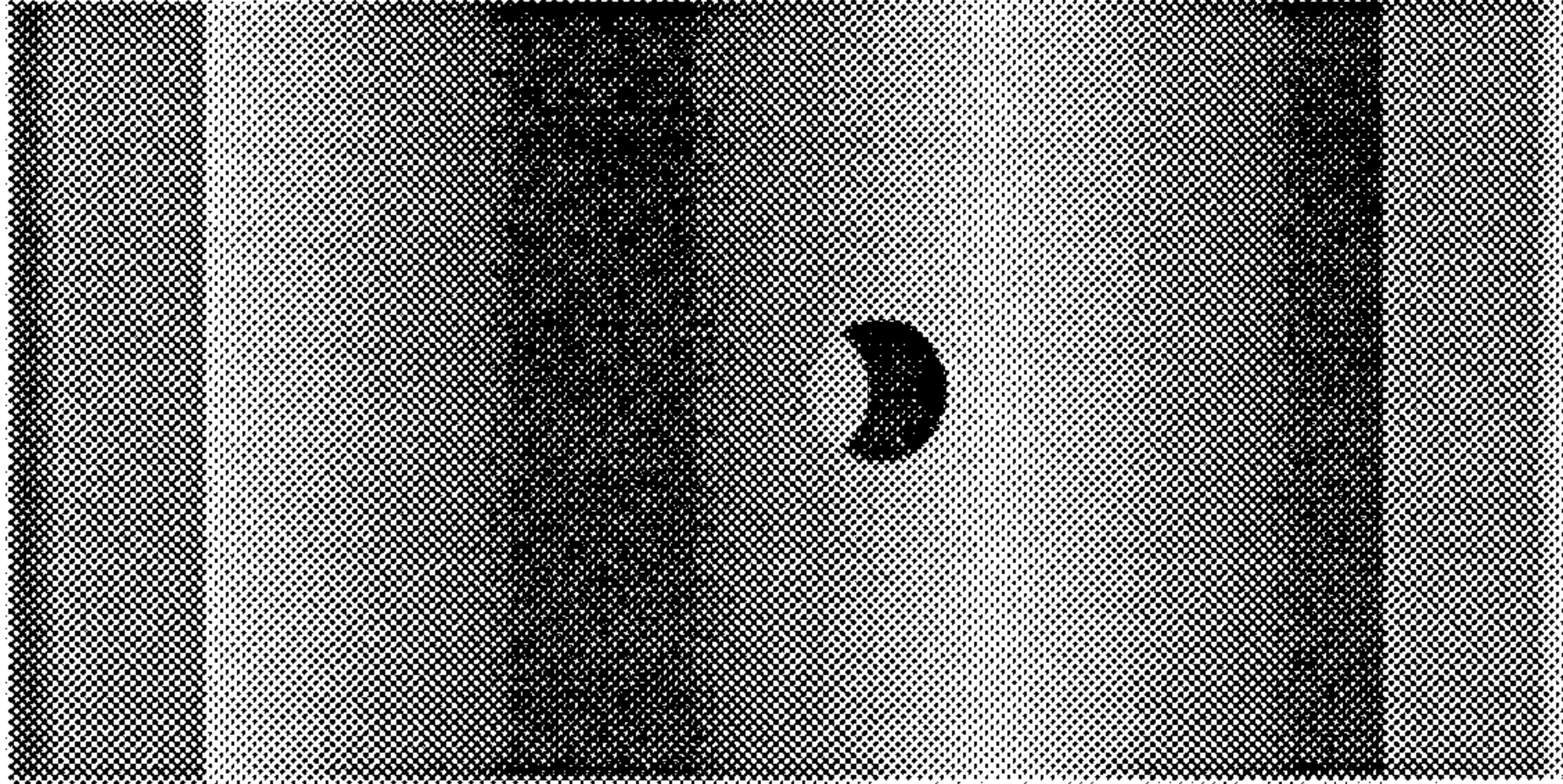

Fig. 31

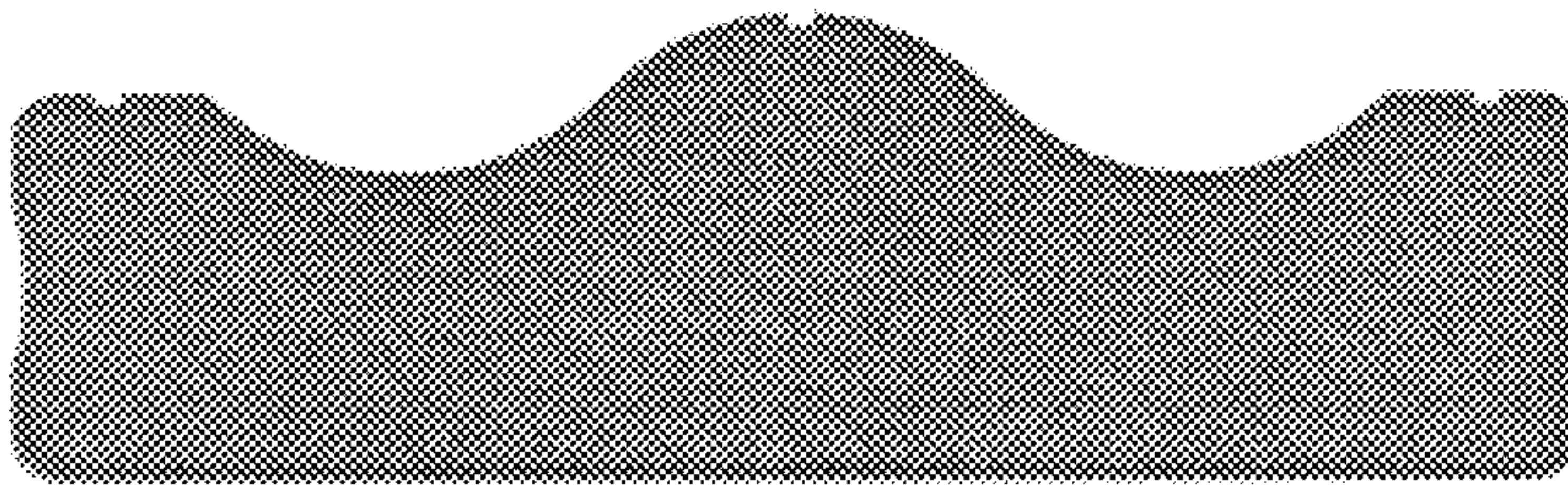

Fig. 32

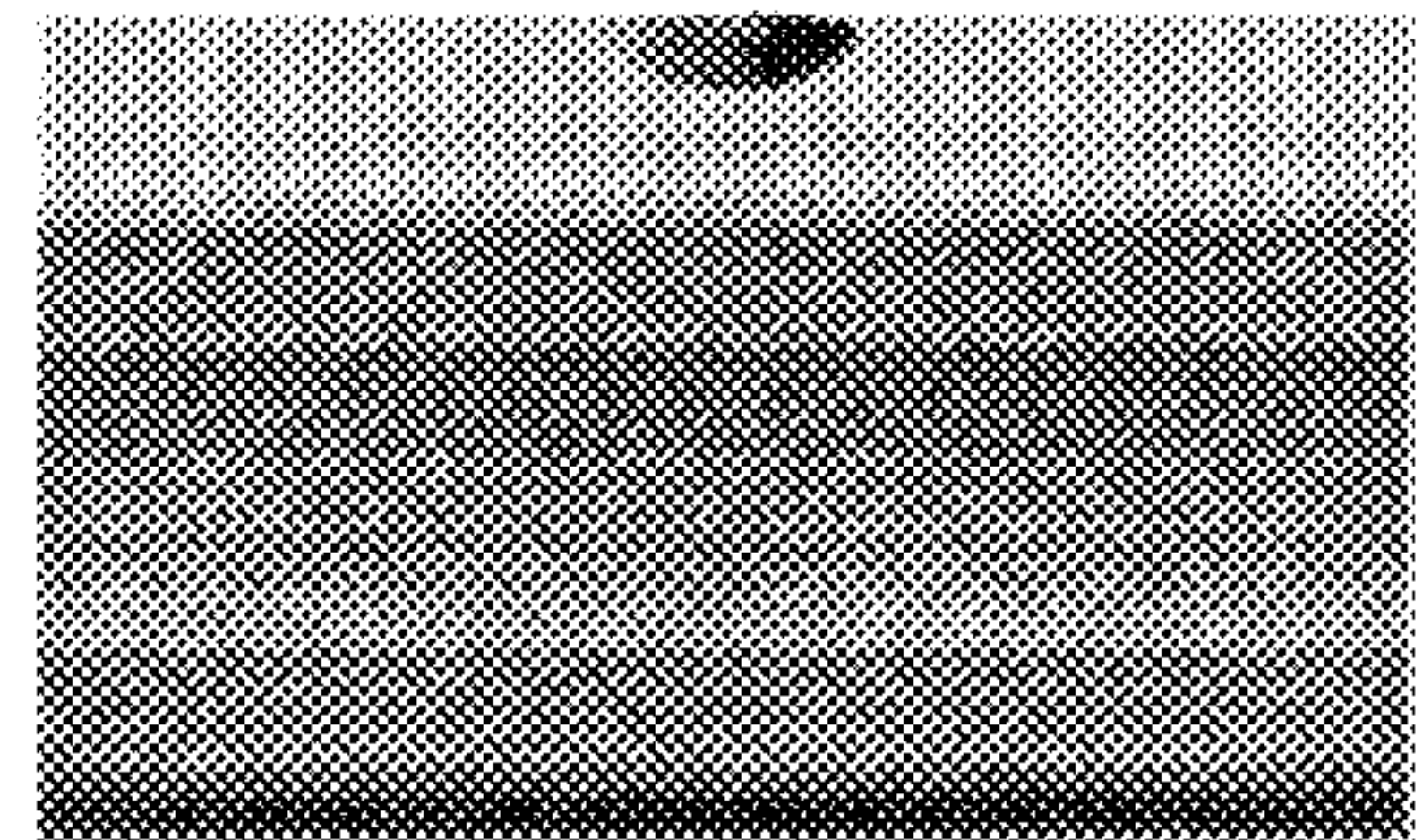

Fig. 33

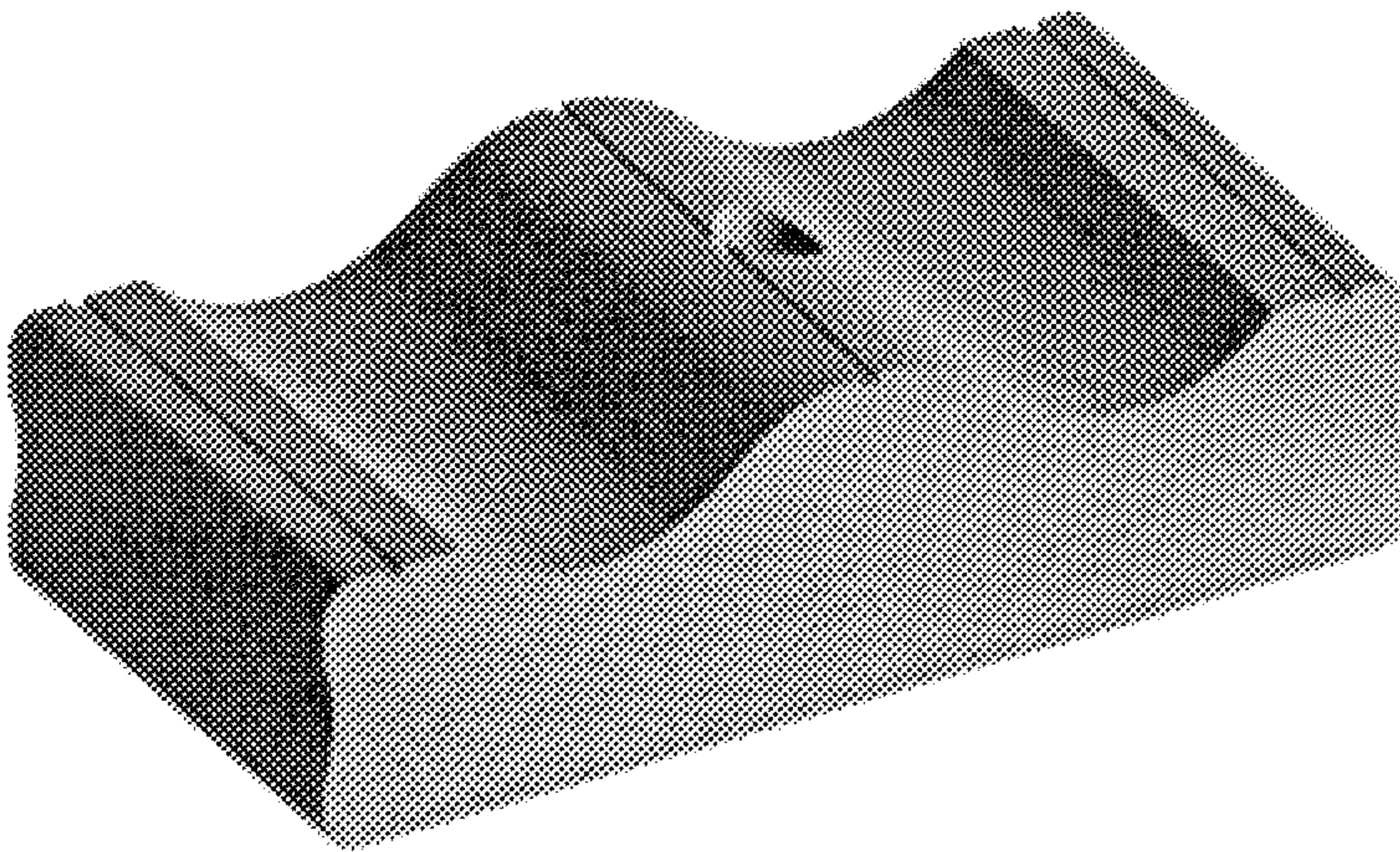

Fig. 34

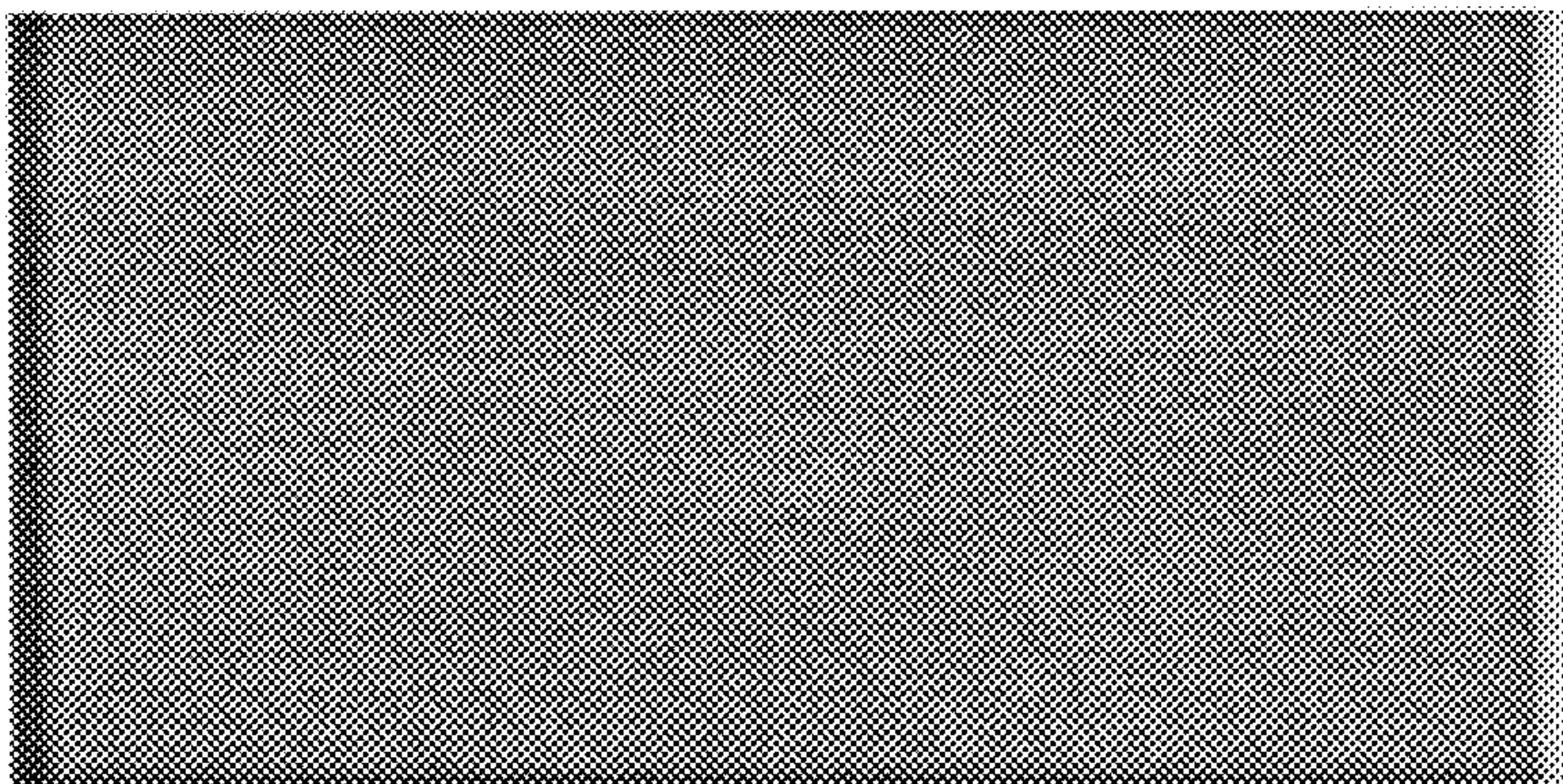

Fig. 35

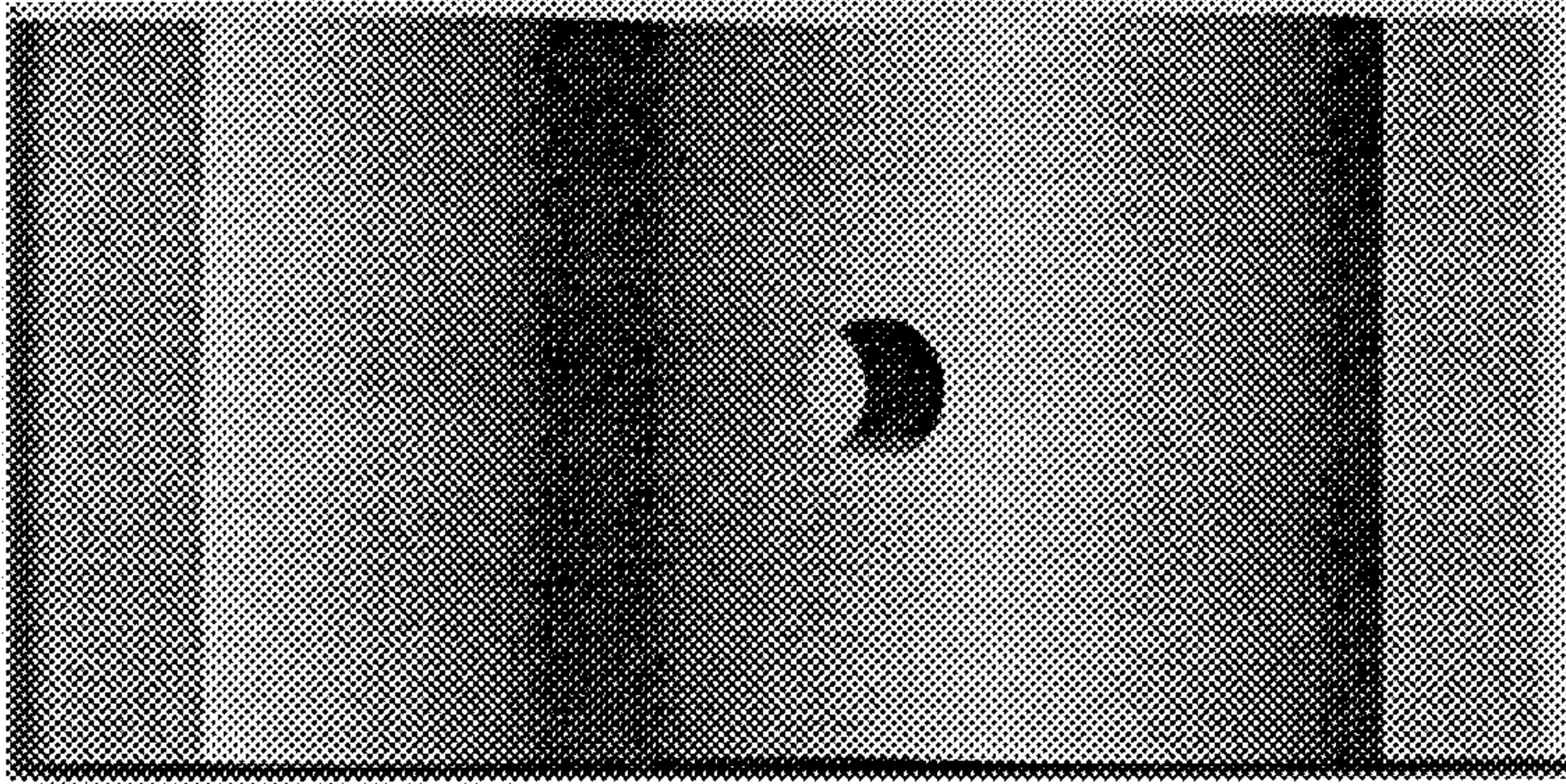

Fig. 36

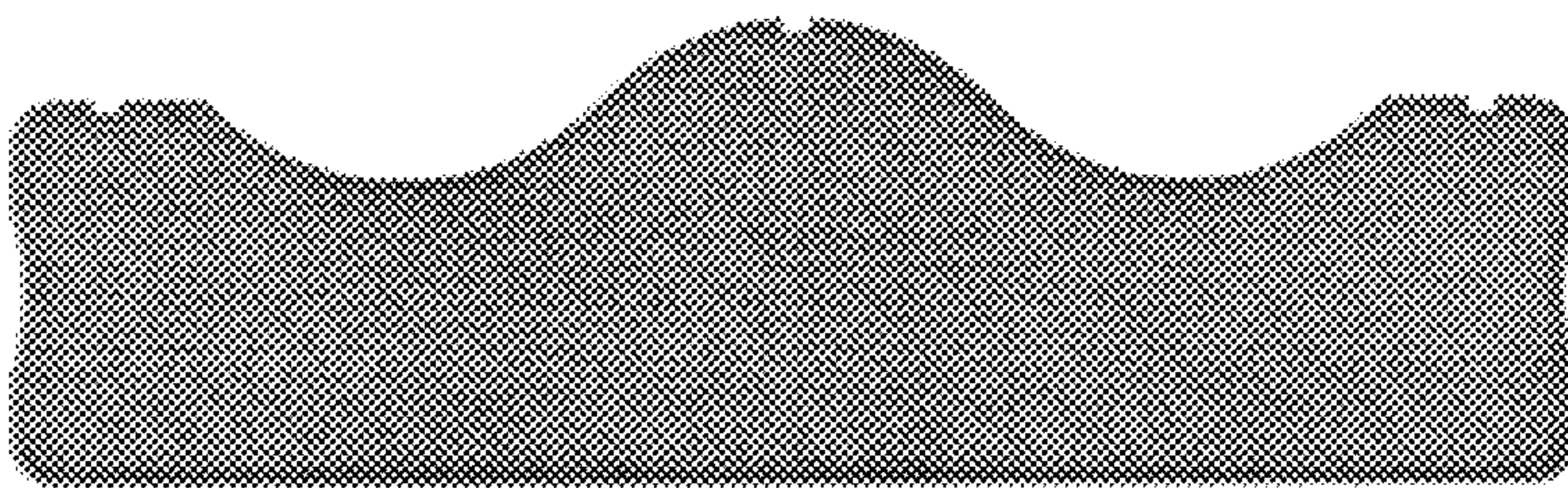

Fig. 37

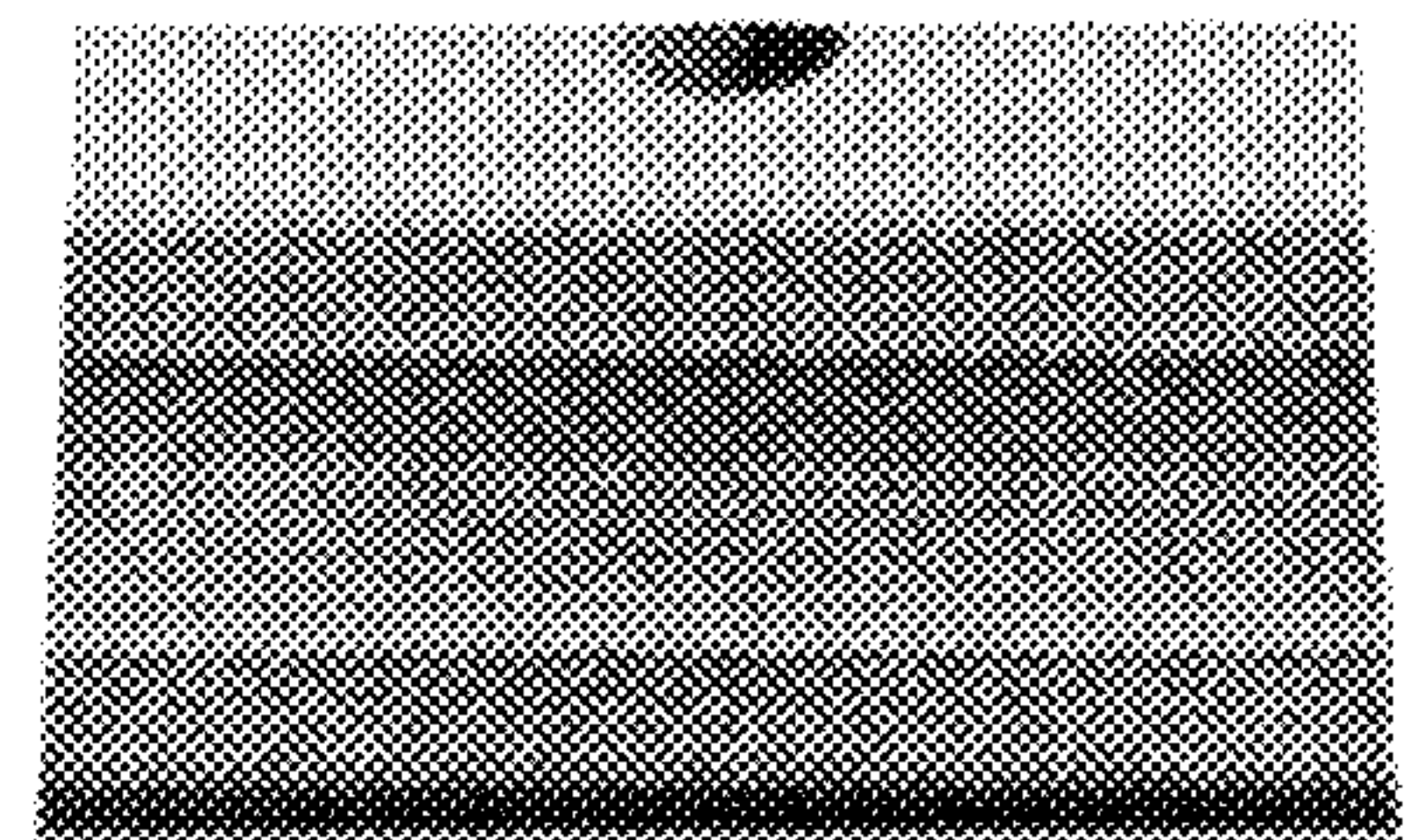

Fig. 38

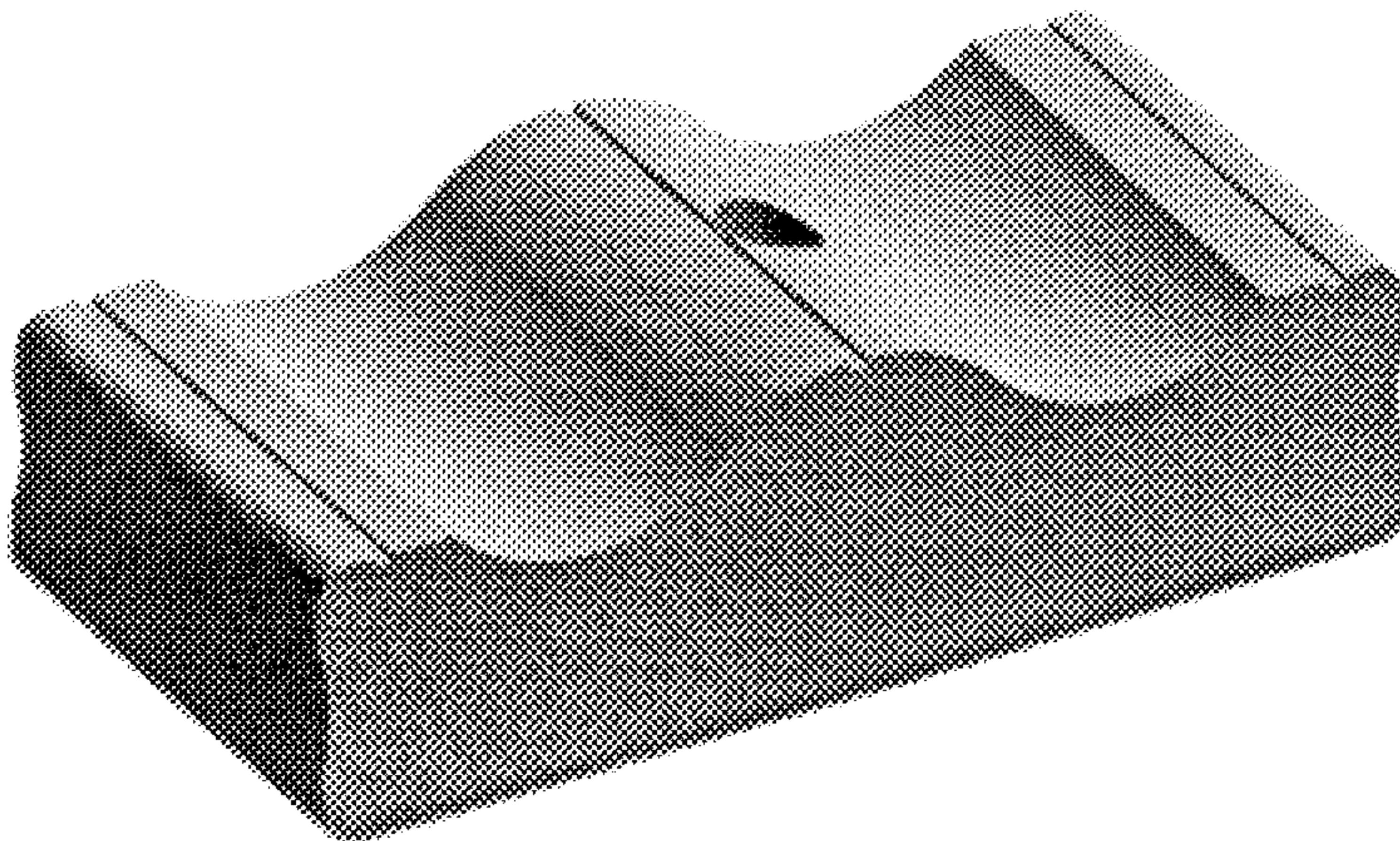

Fig. 39

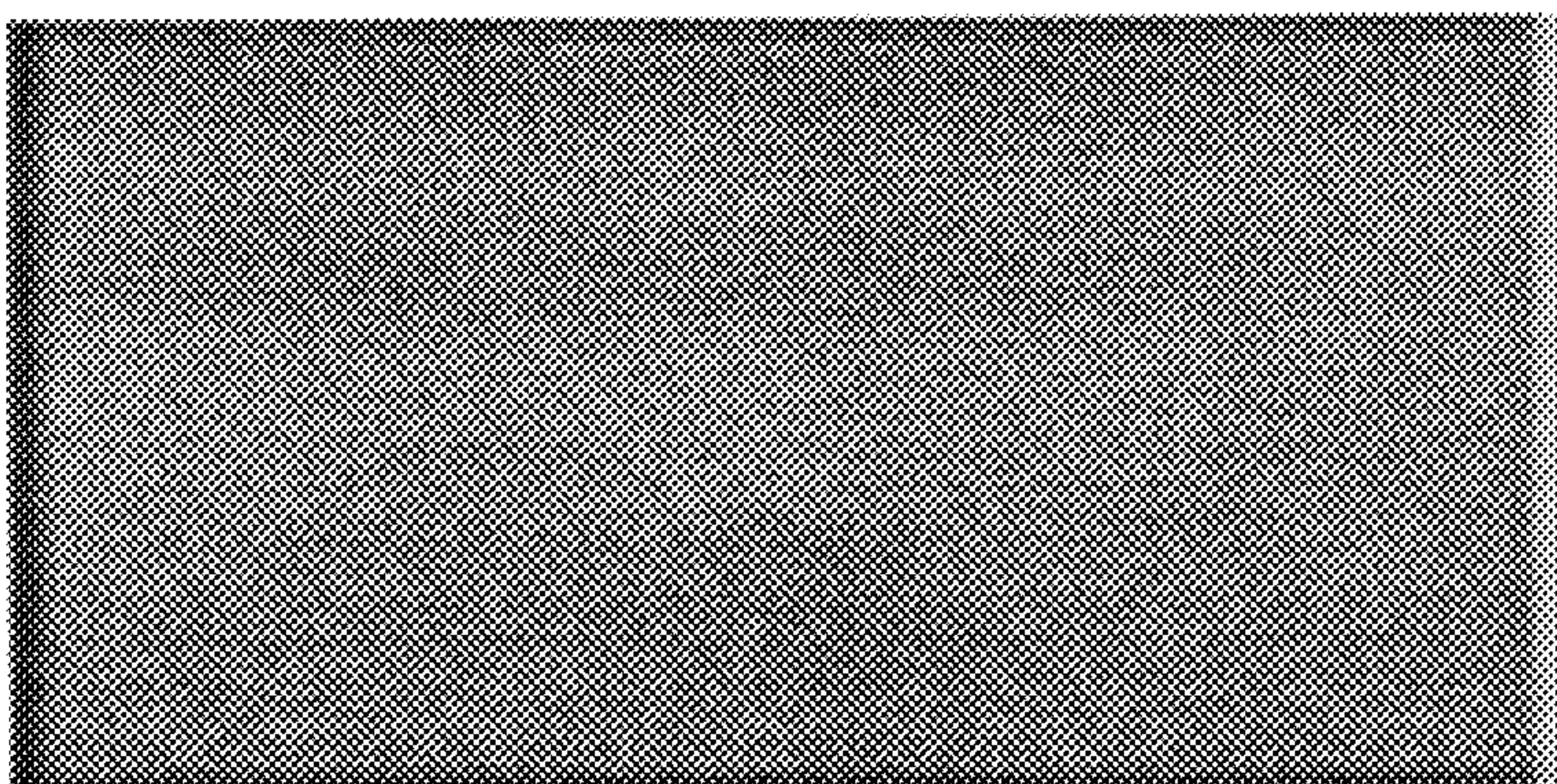

Fig. 40

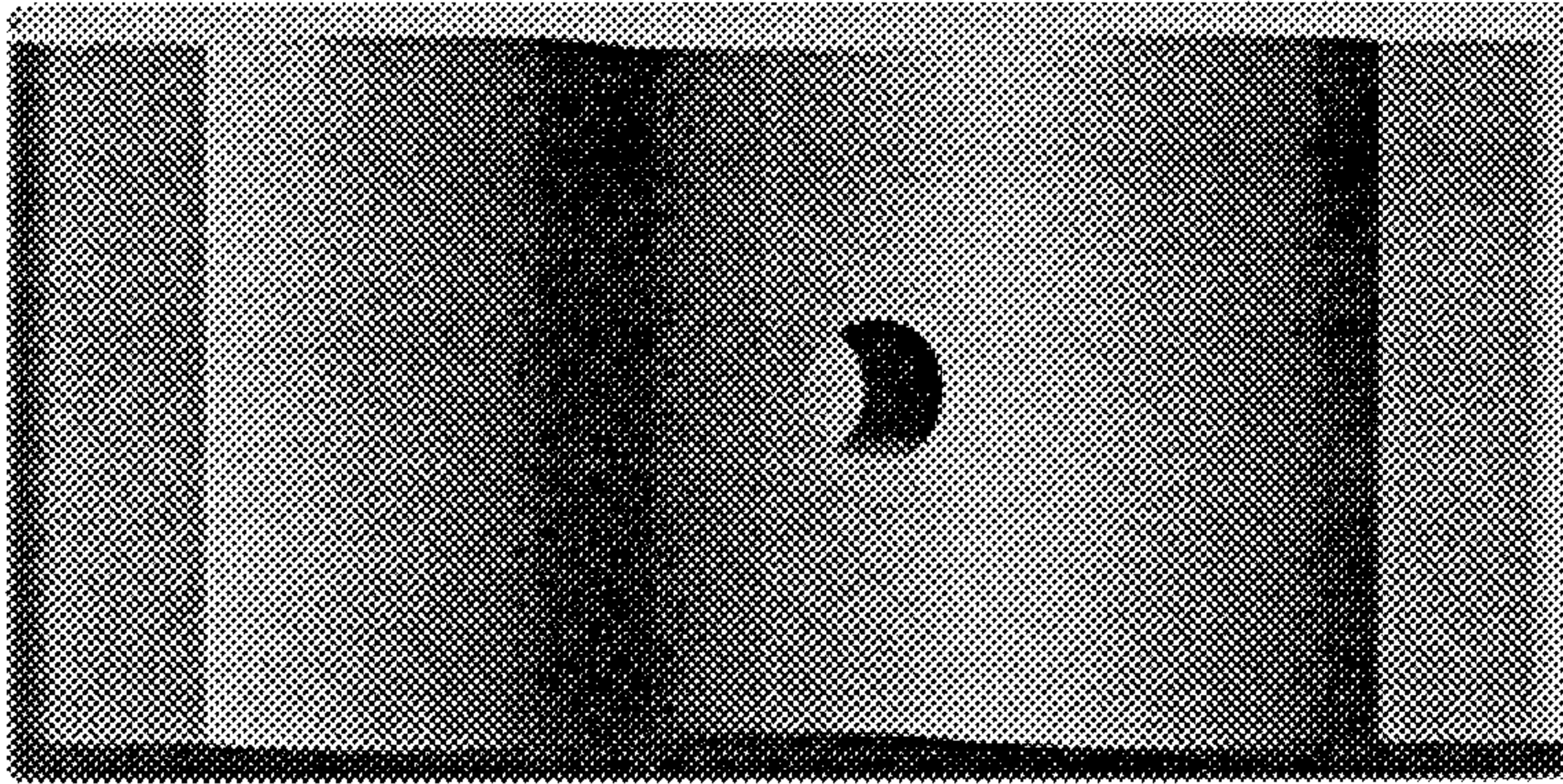

Fig. 41

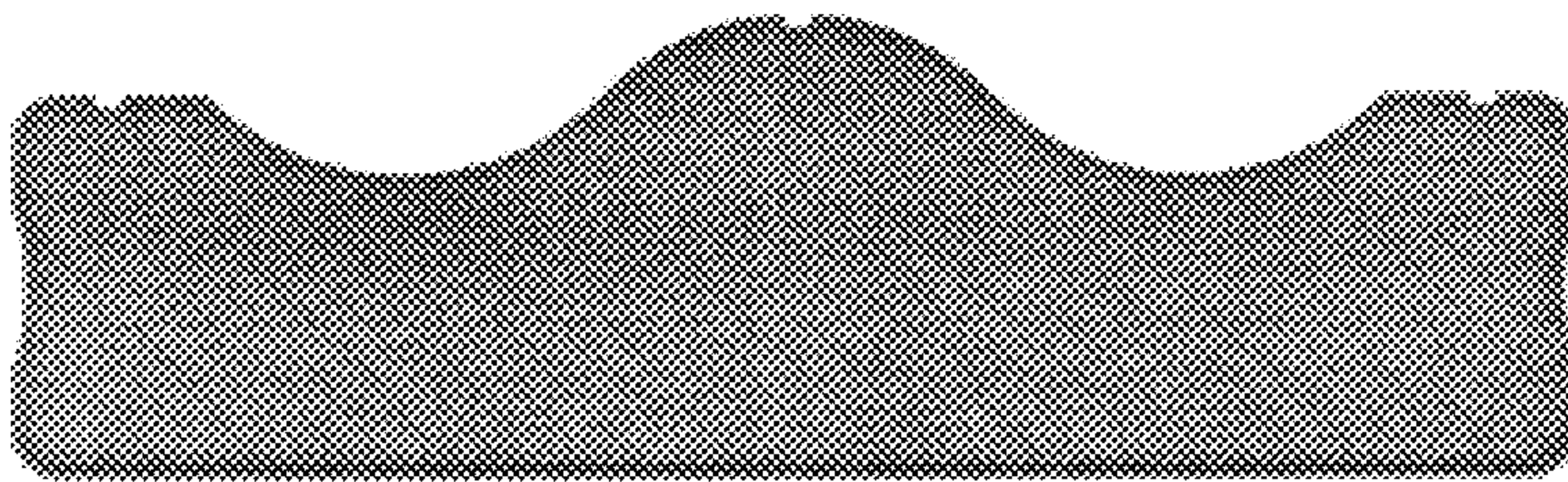

Fig. 42

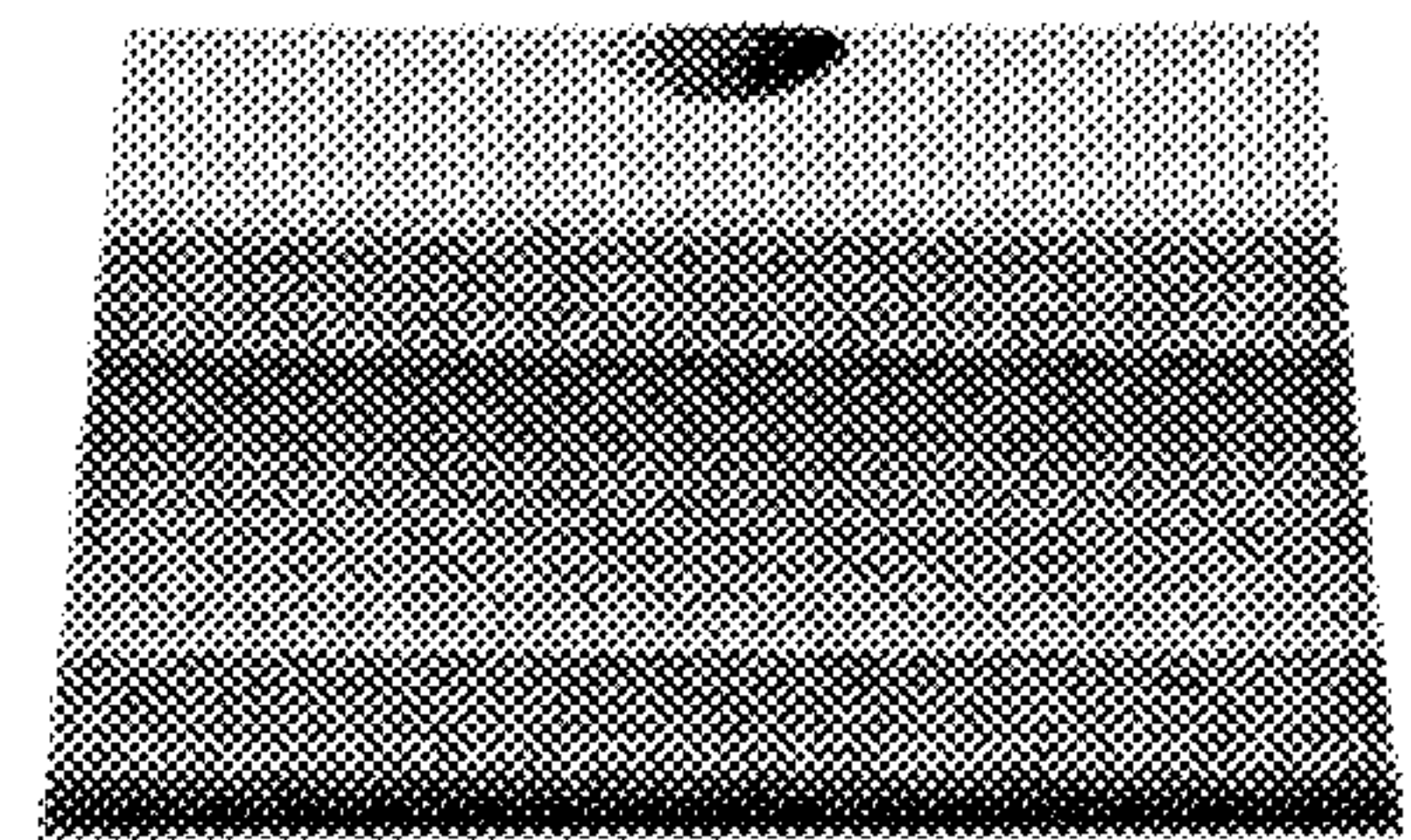

Fig. 43

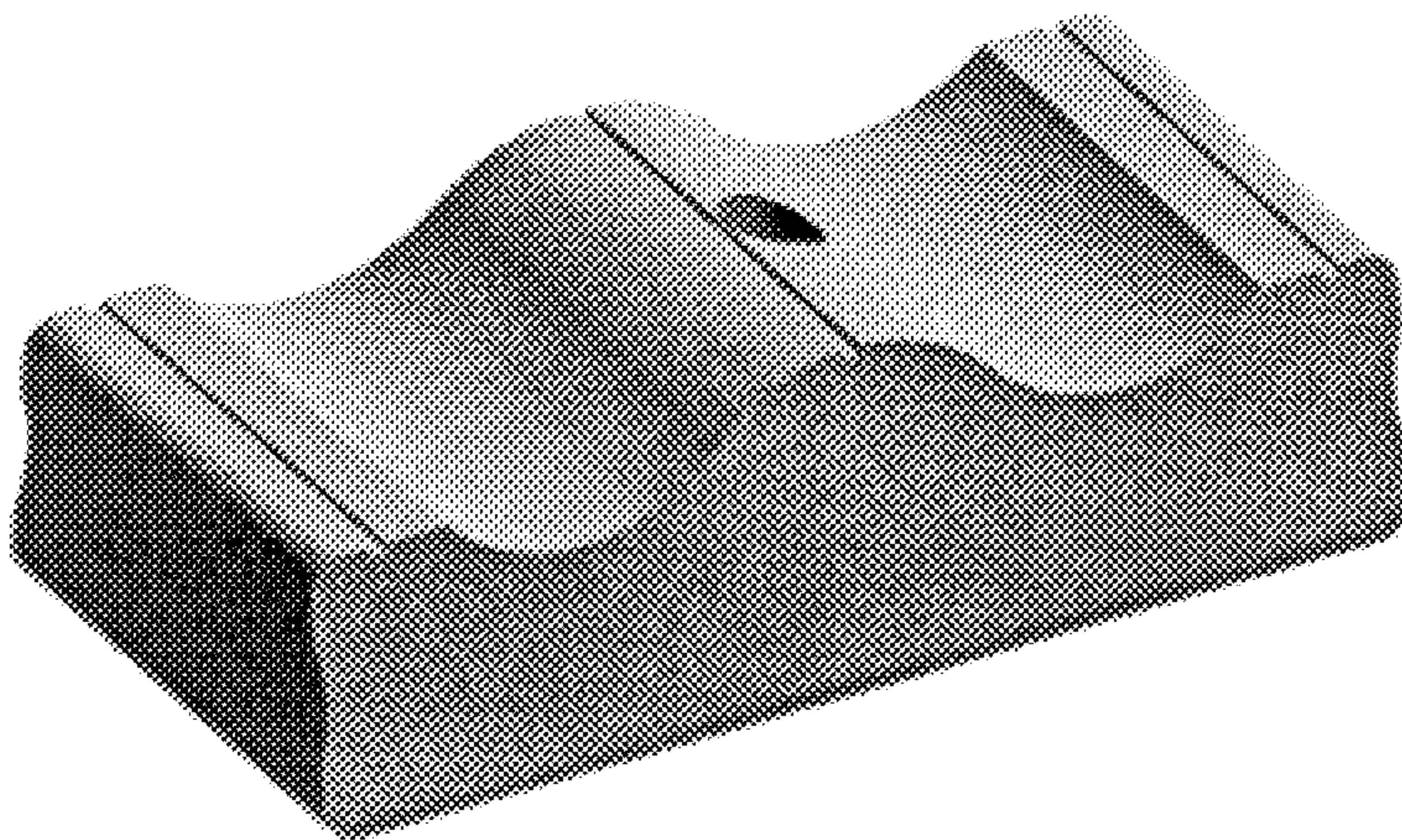

Fig. 44

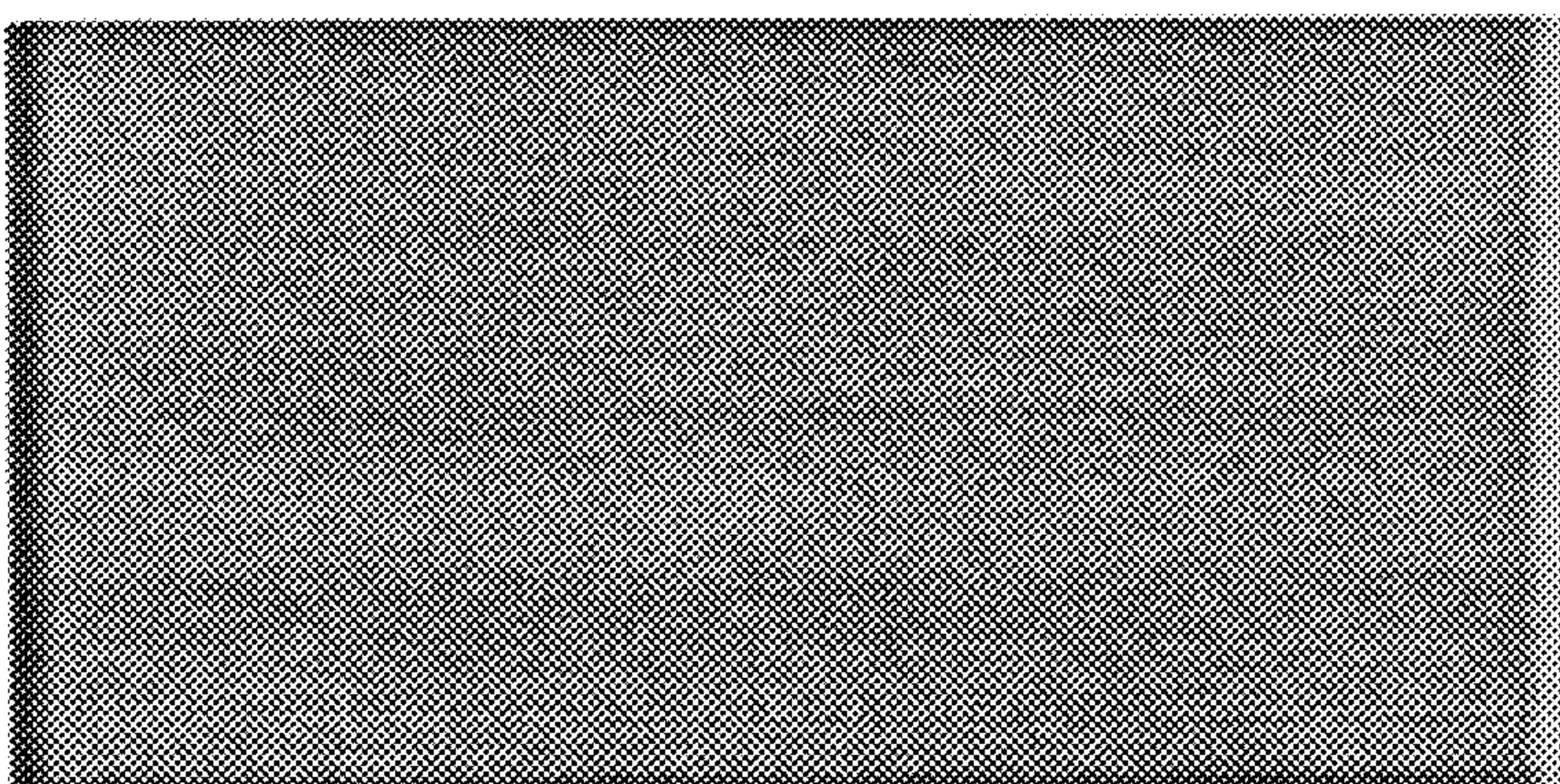

Fig. 45

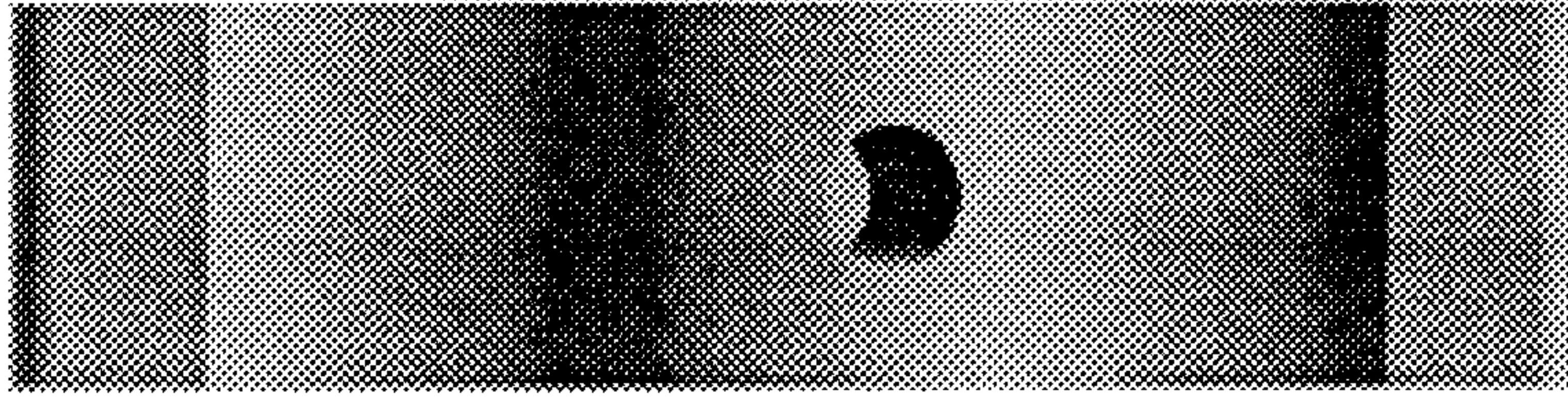

Fig. 46

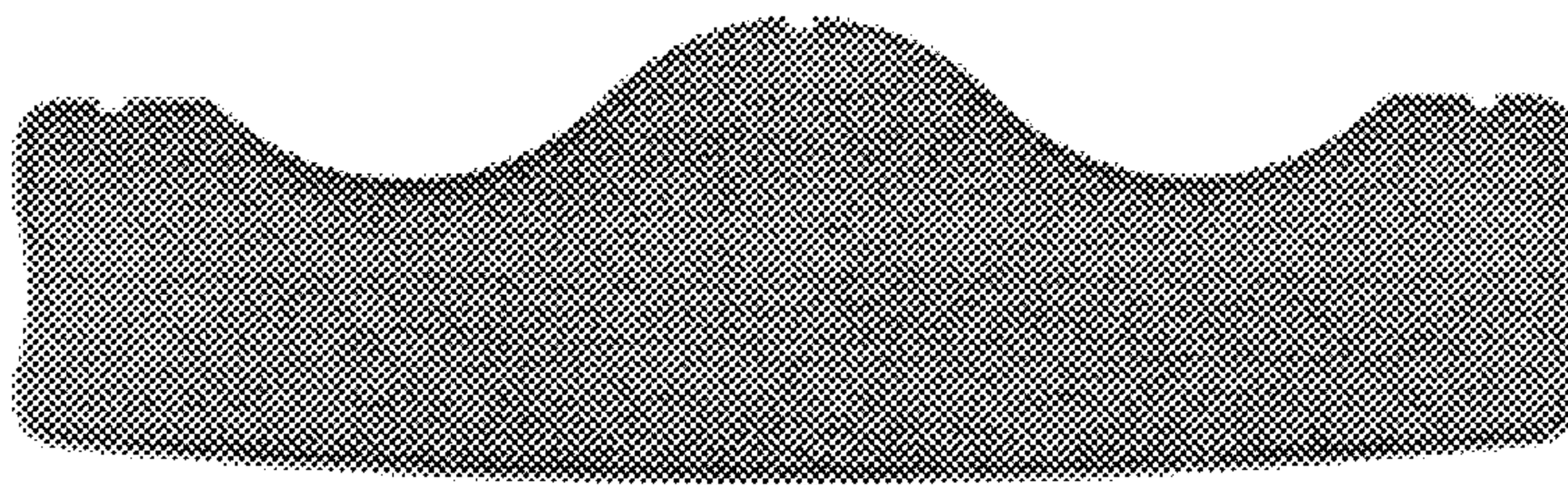

Fig. 47

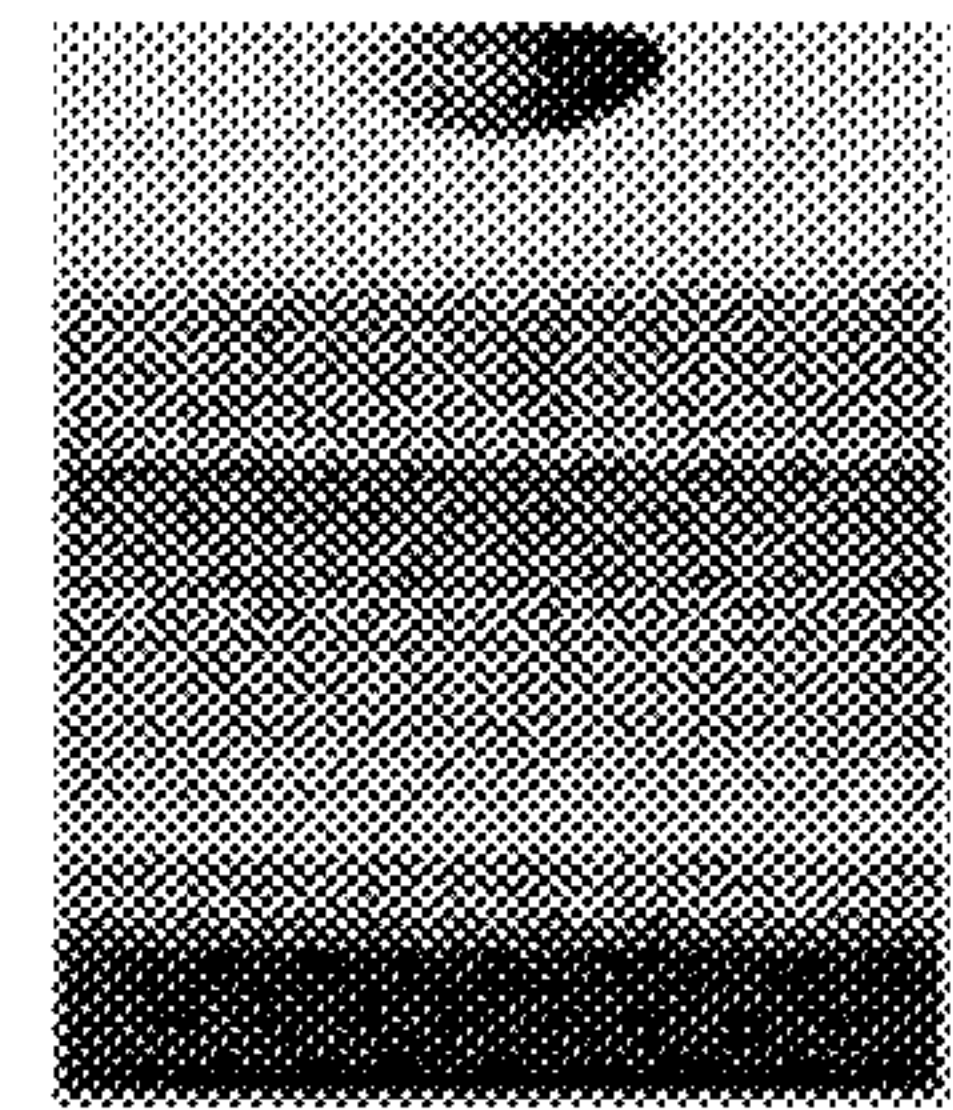

Fig. 48

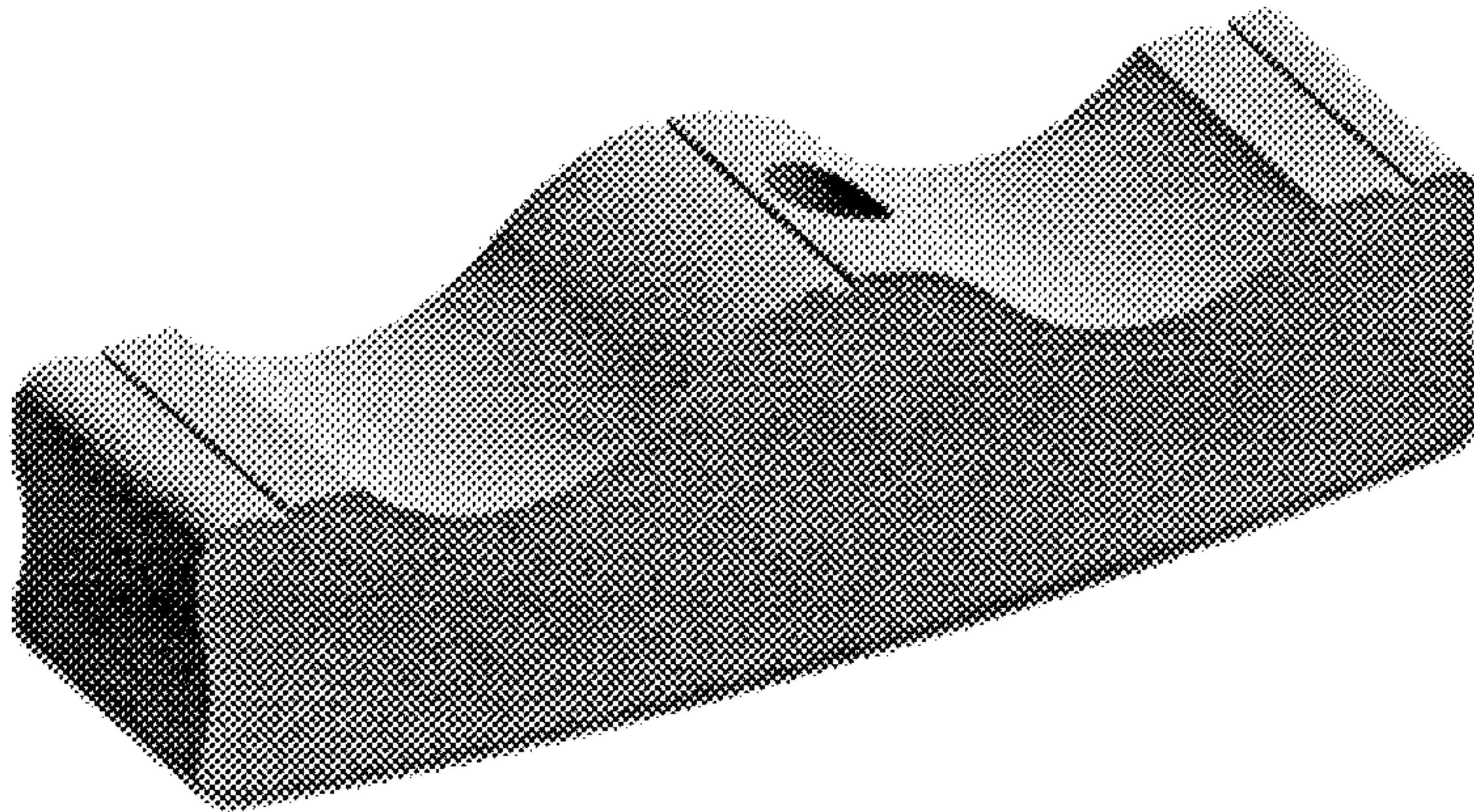

Fig. 49

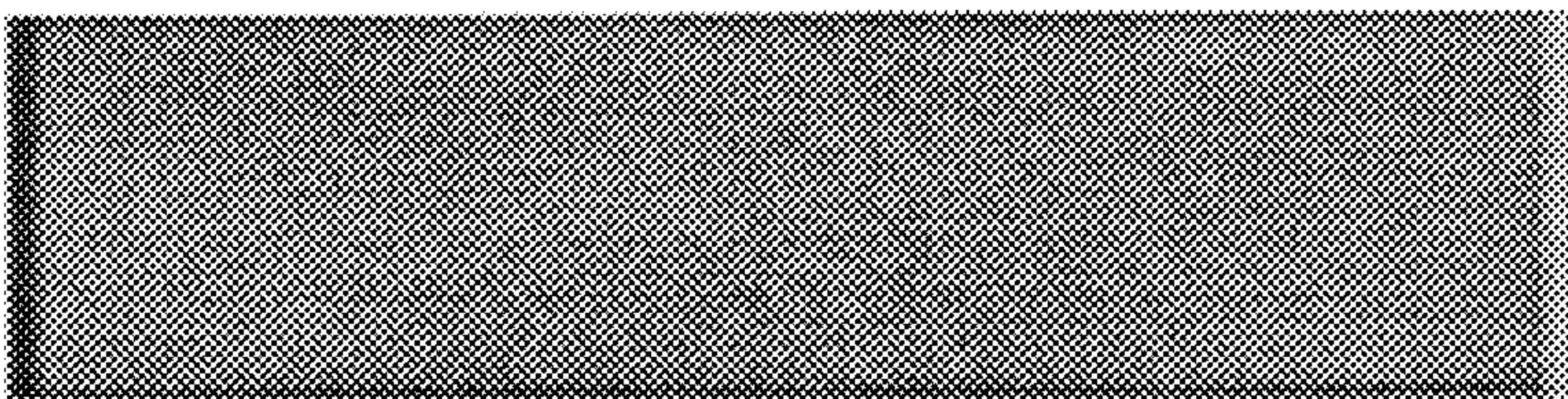

Fig. 50

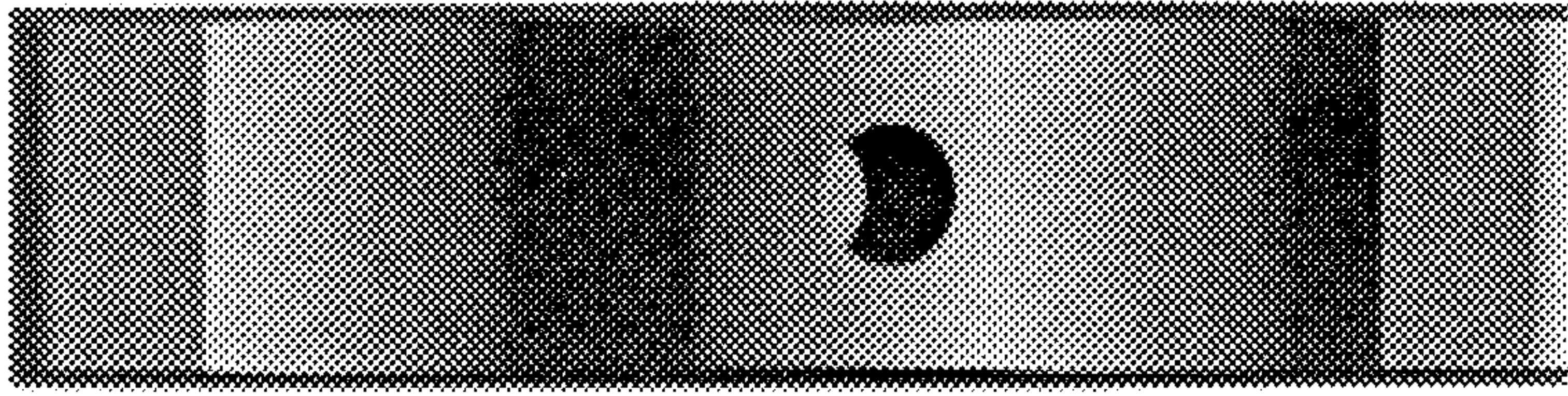

Fig. 51

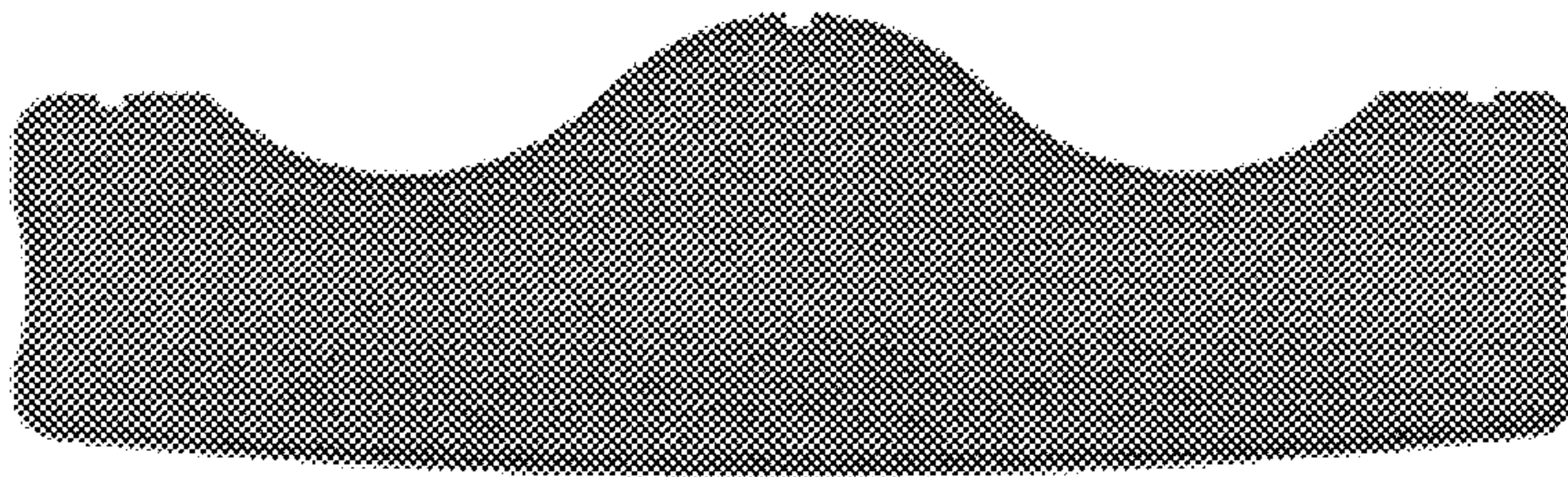

Fig. 52

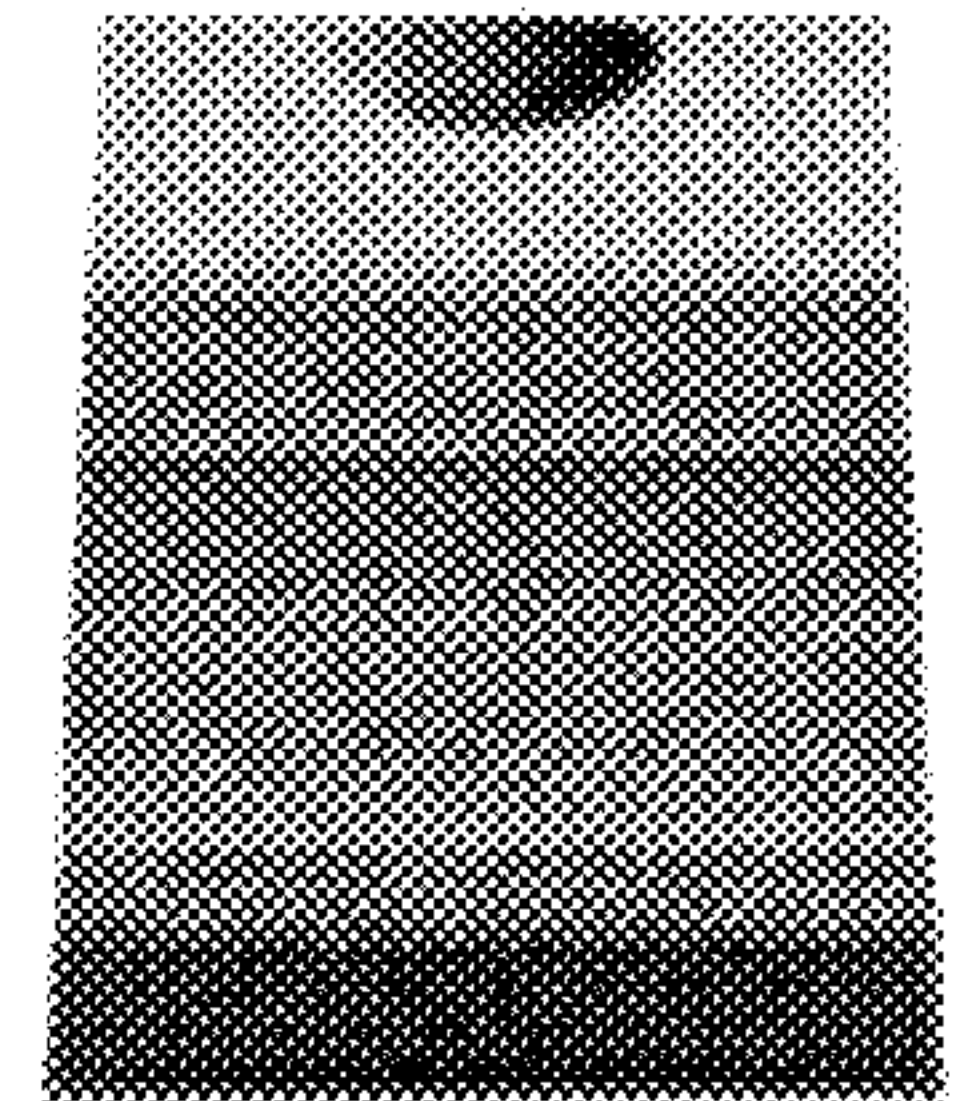

Fig. 53

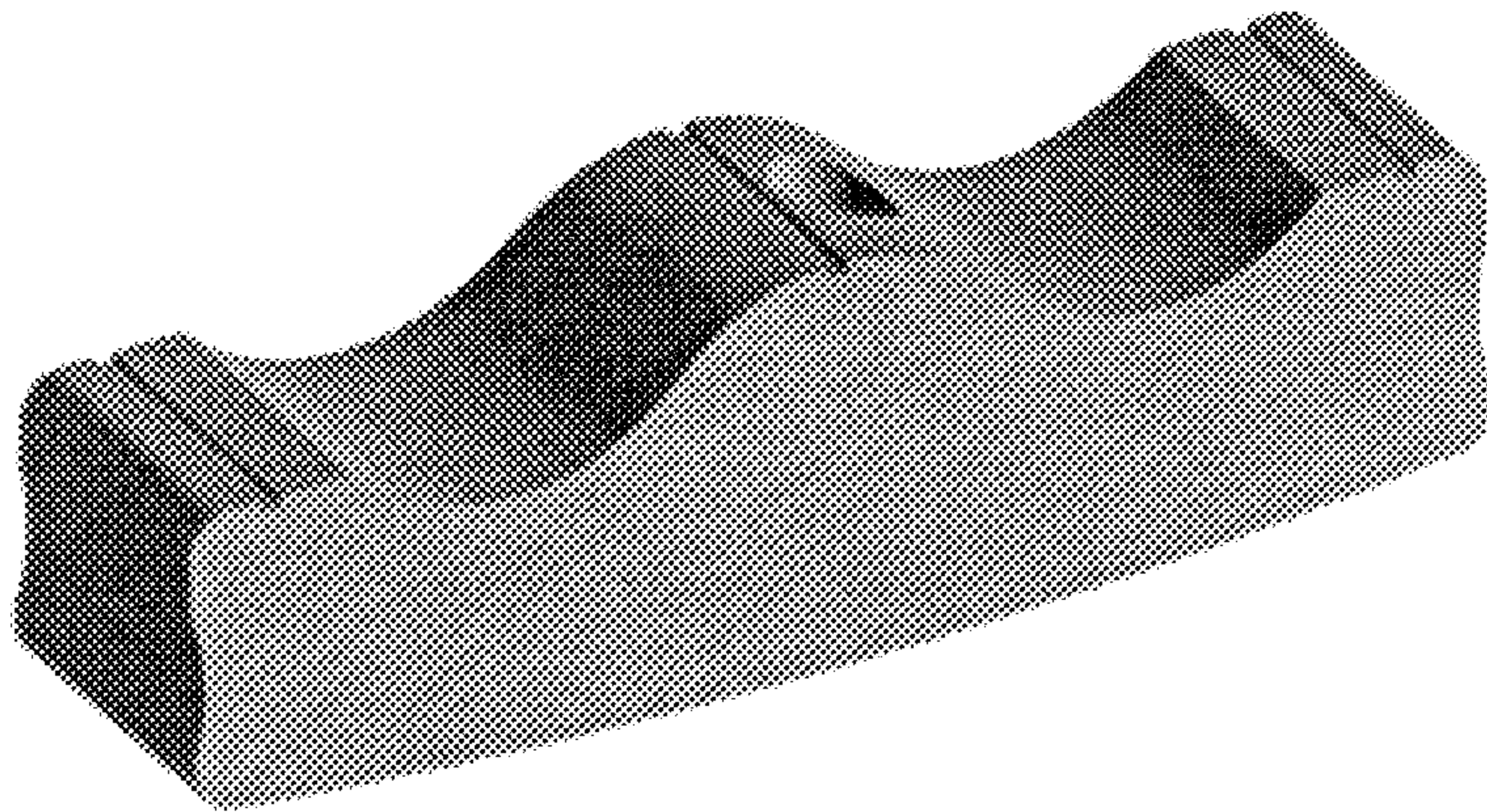

Fig. 54

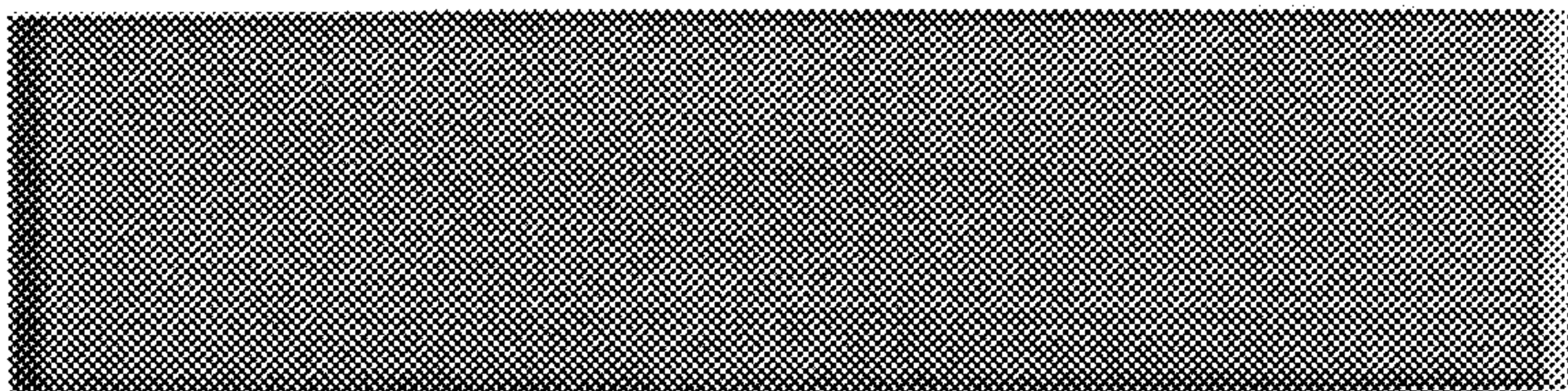

Fig. 55

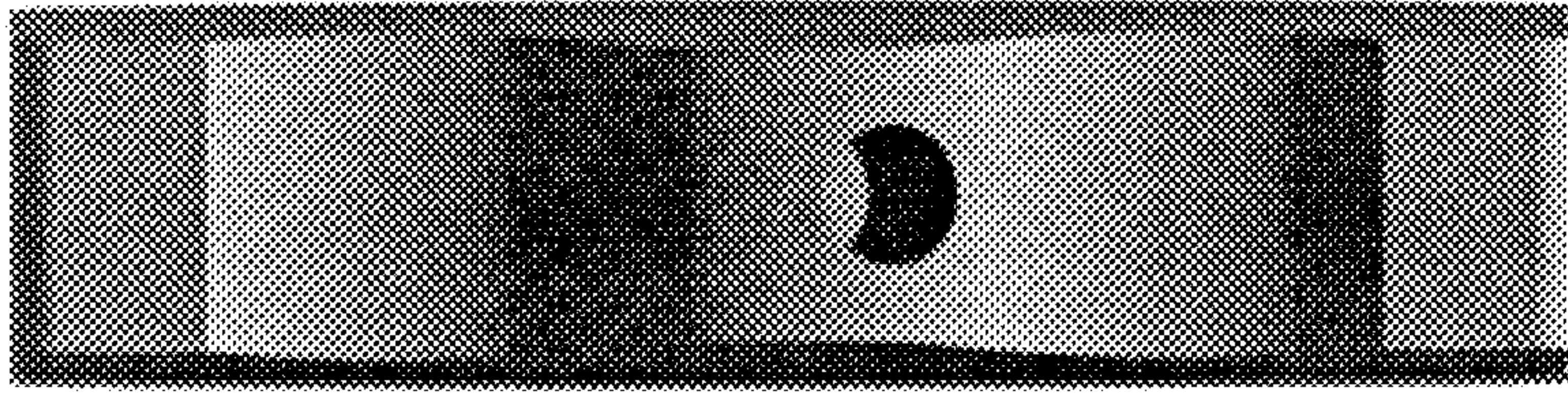

Fig. 56

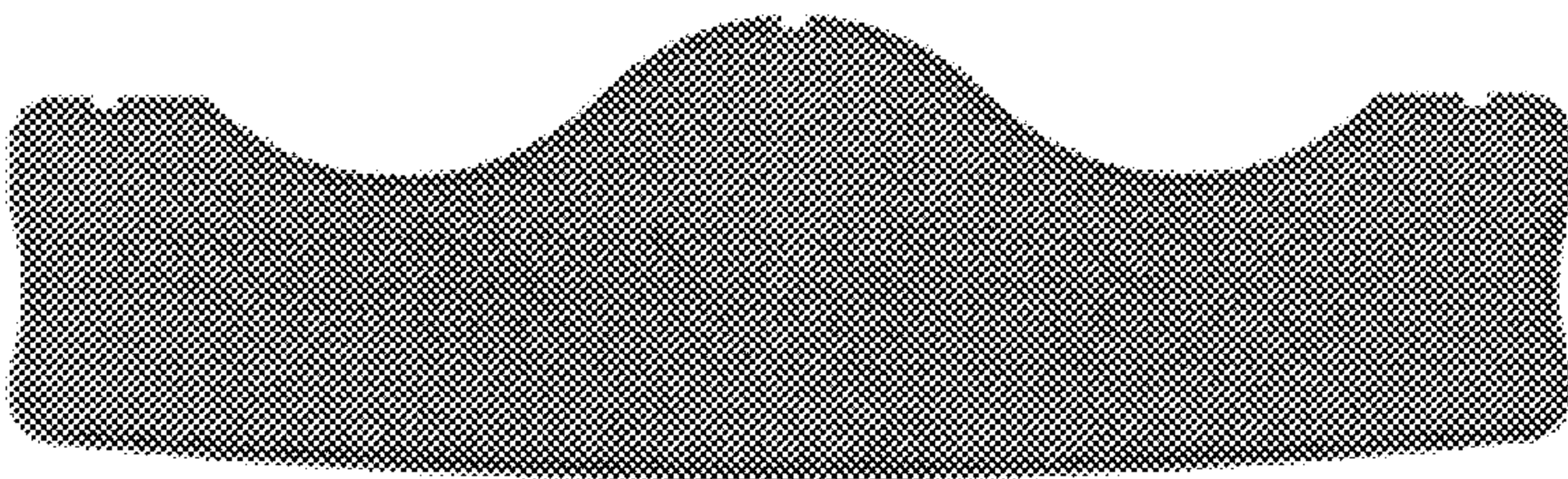

Fig. 57

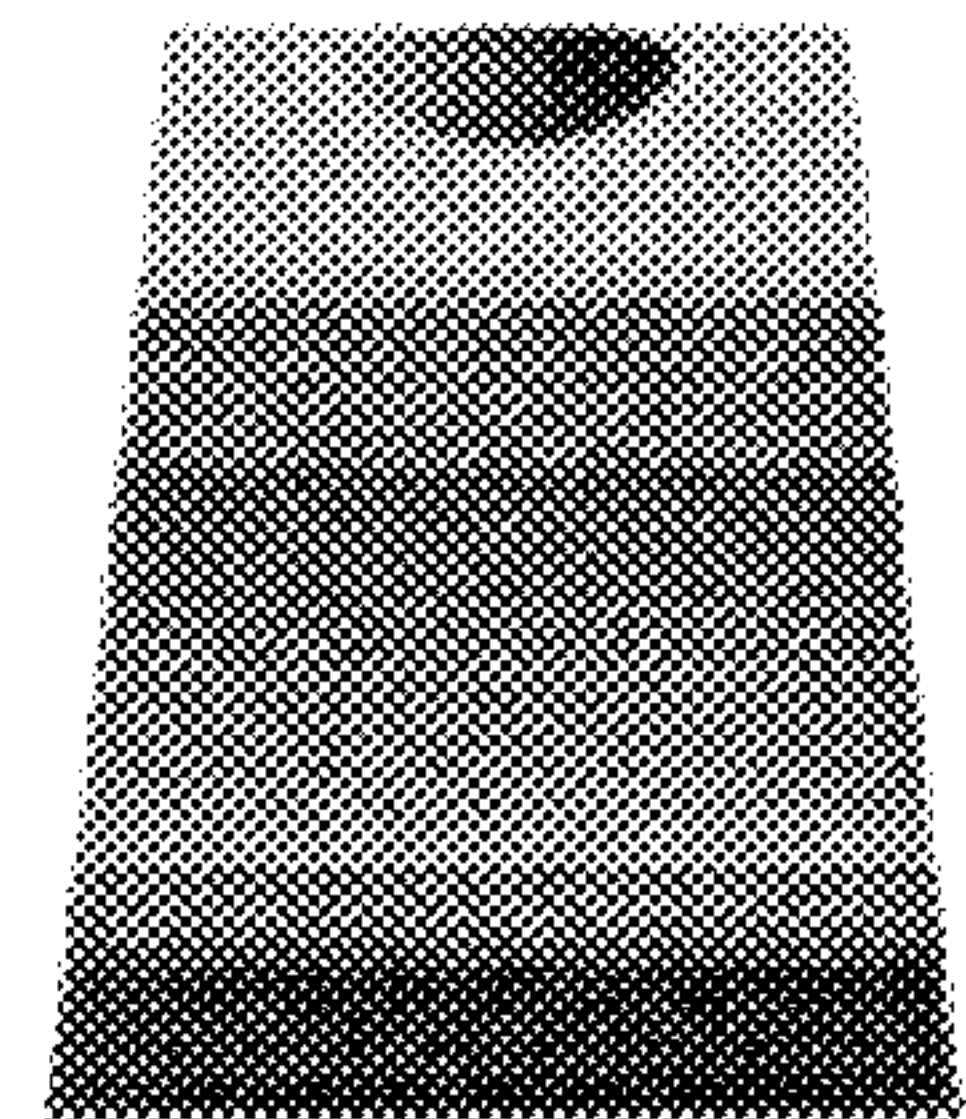

Fig. 58

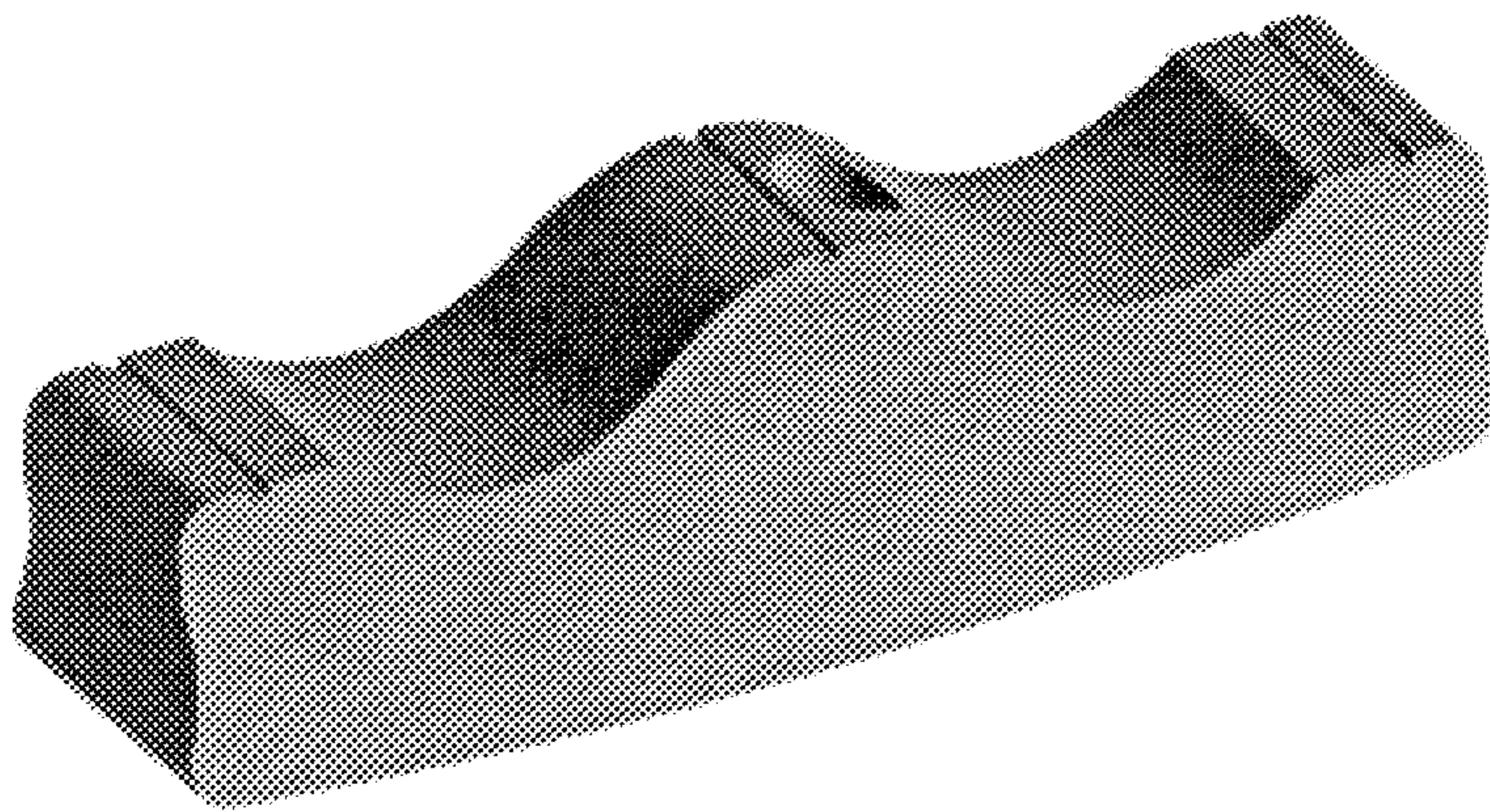

Fig. 59

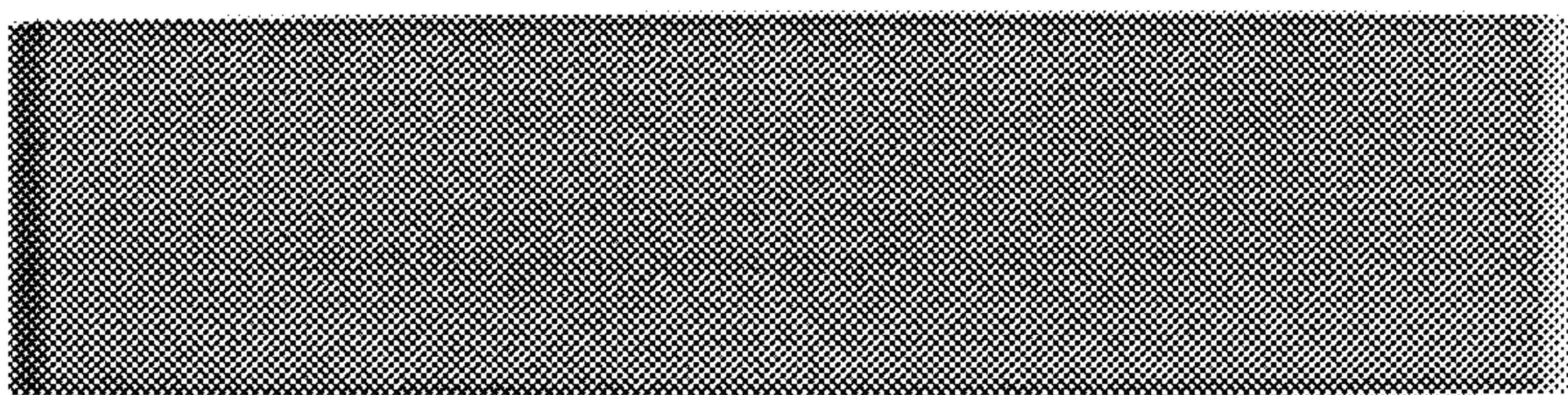

Fig. 60

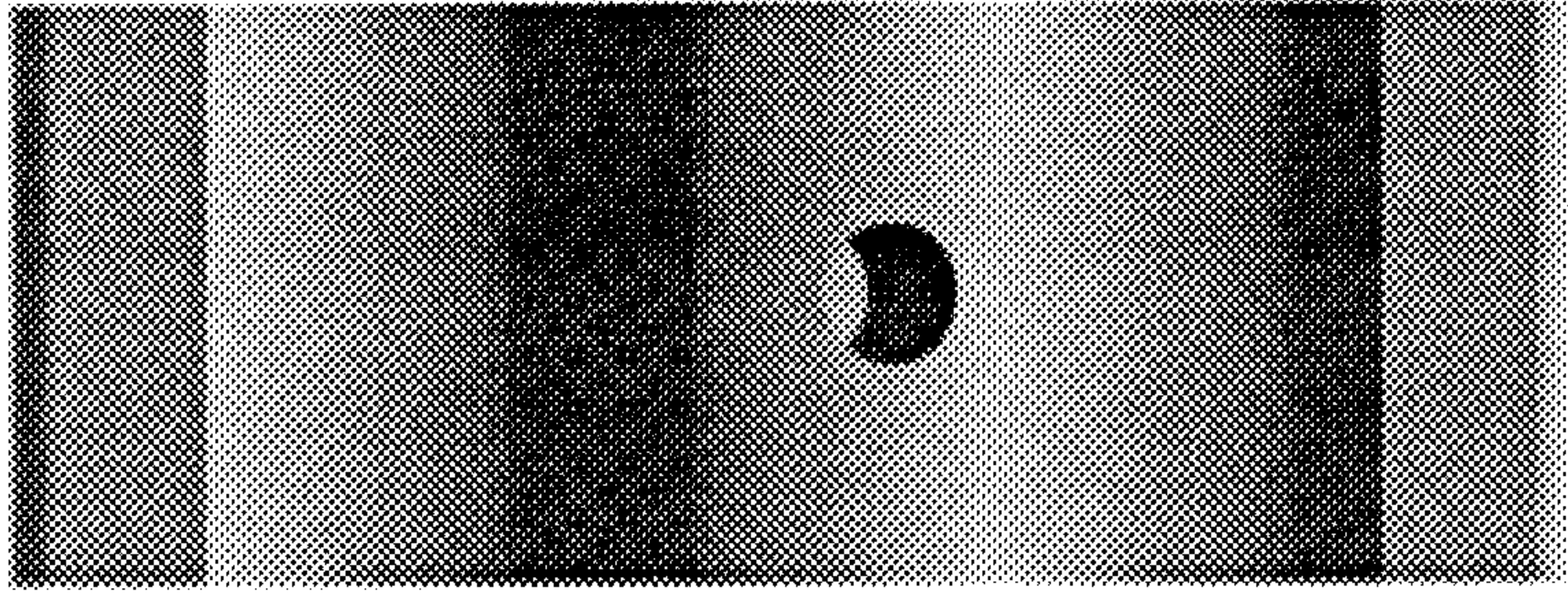

Fig. 61

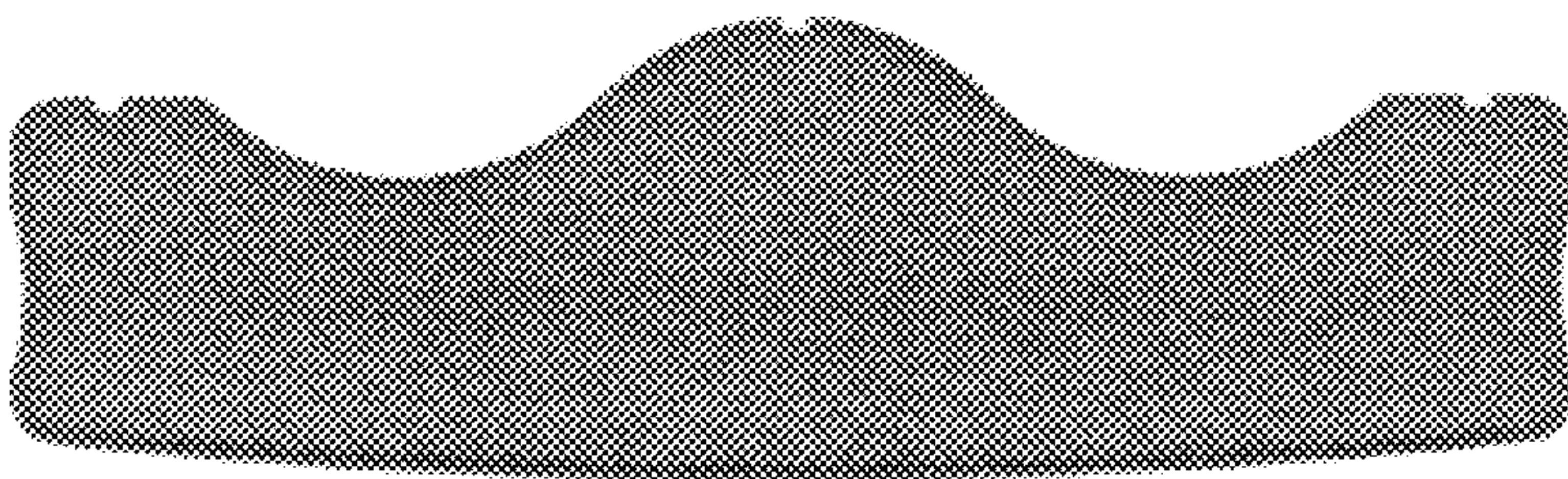

Fig. 62

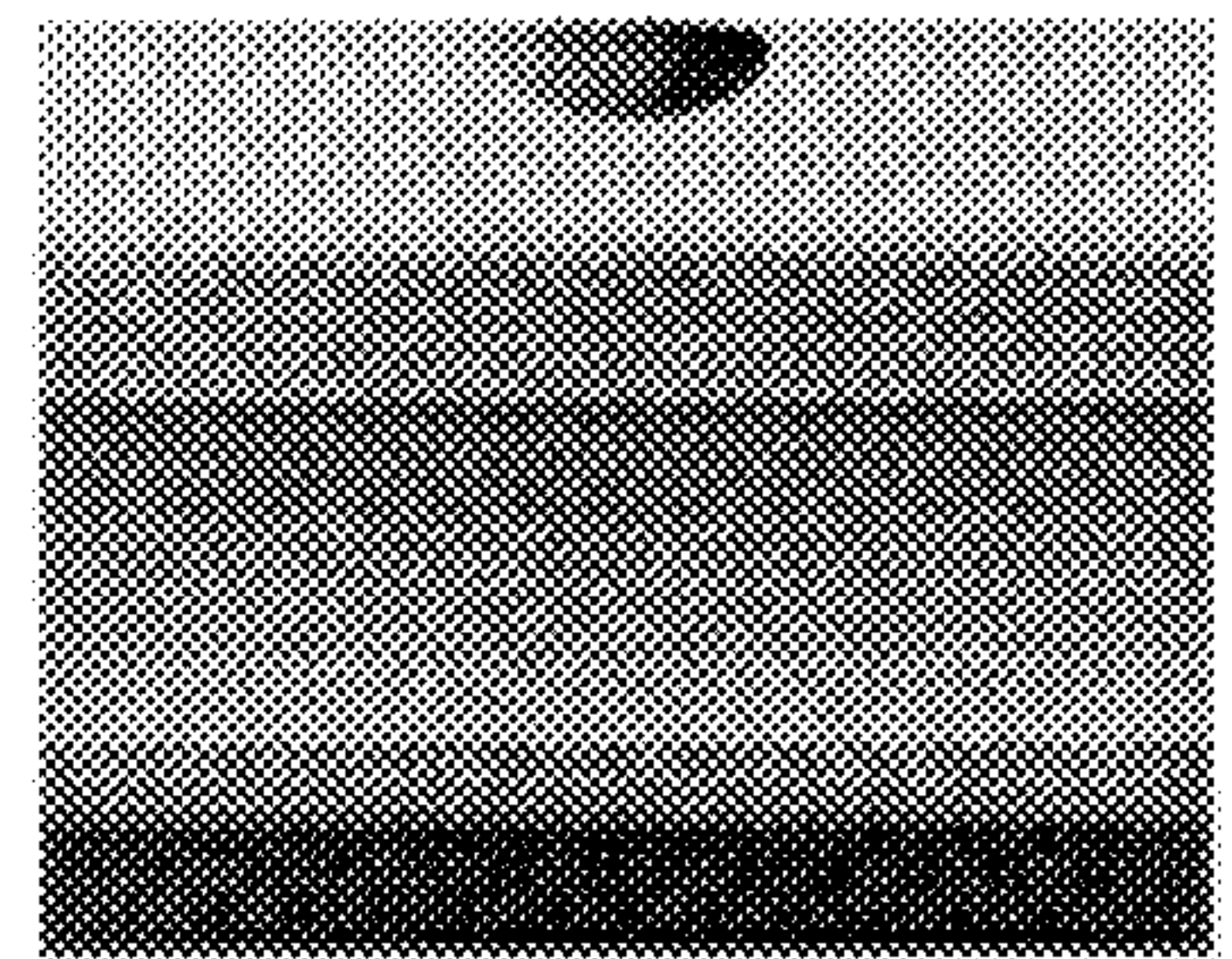

Fig. 63

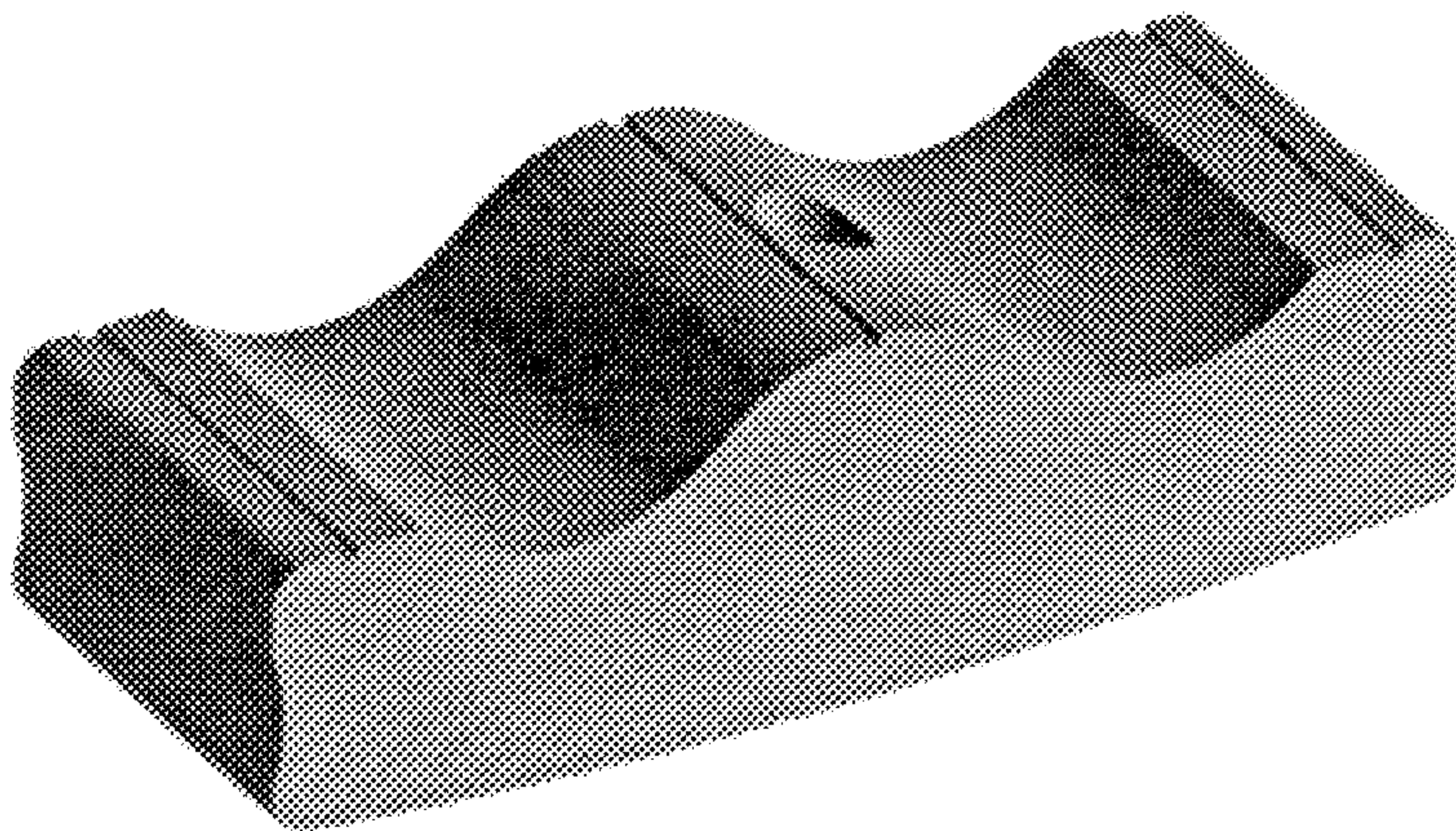

Fig. 64

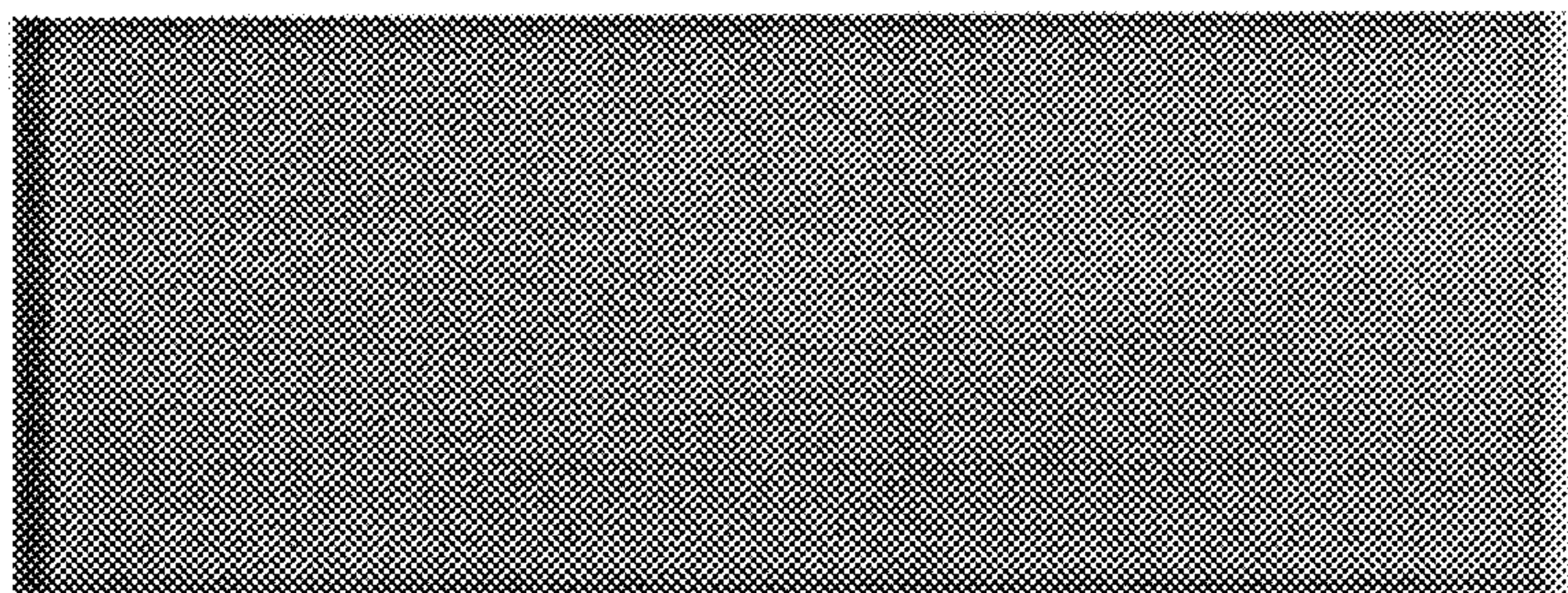

Fig. 65

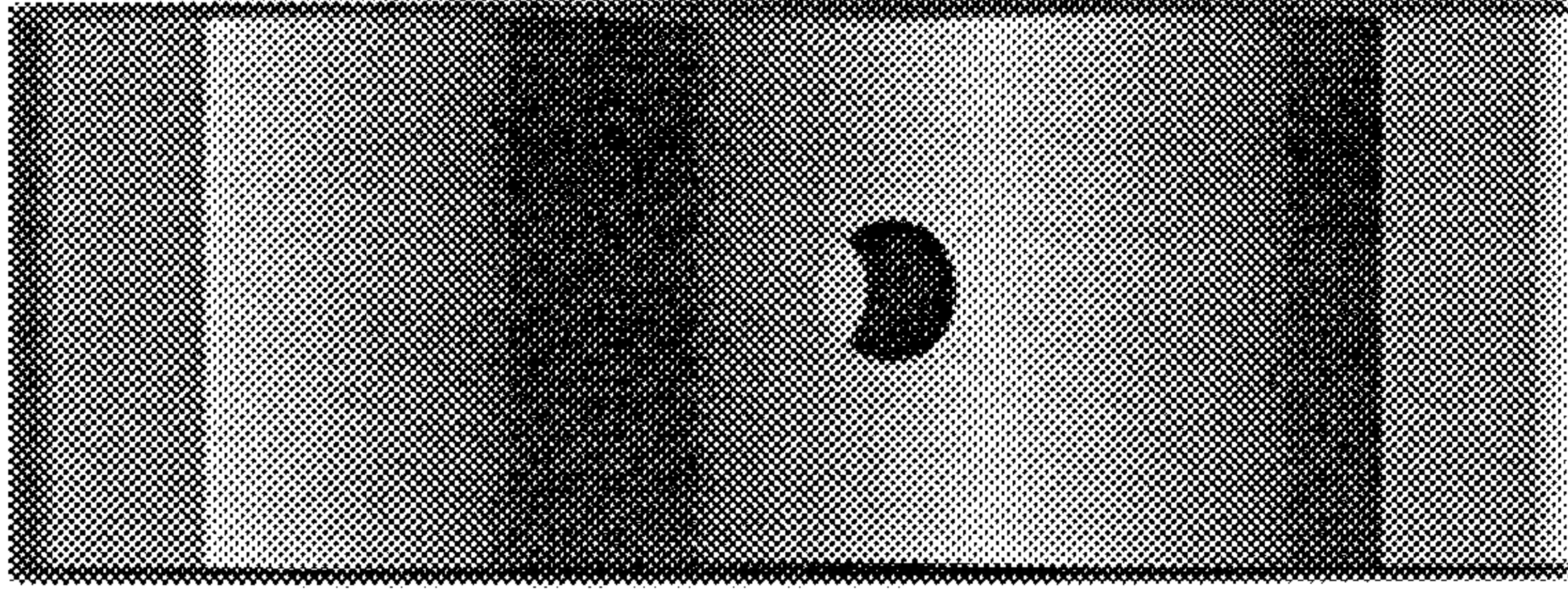

Fig. 66

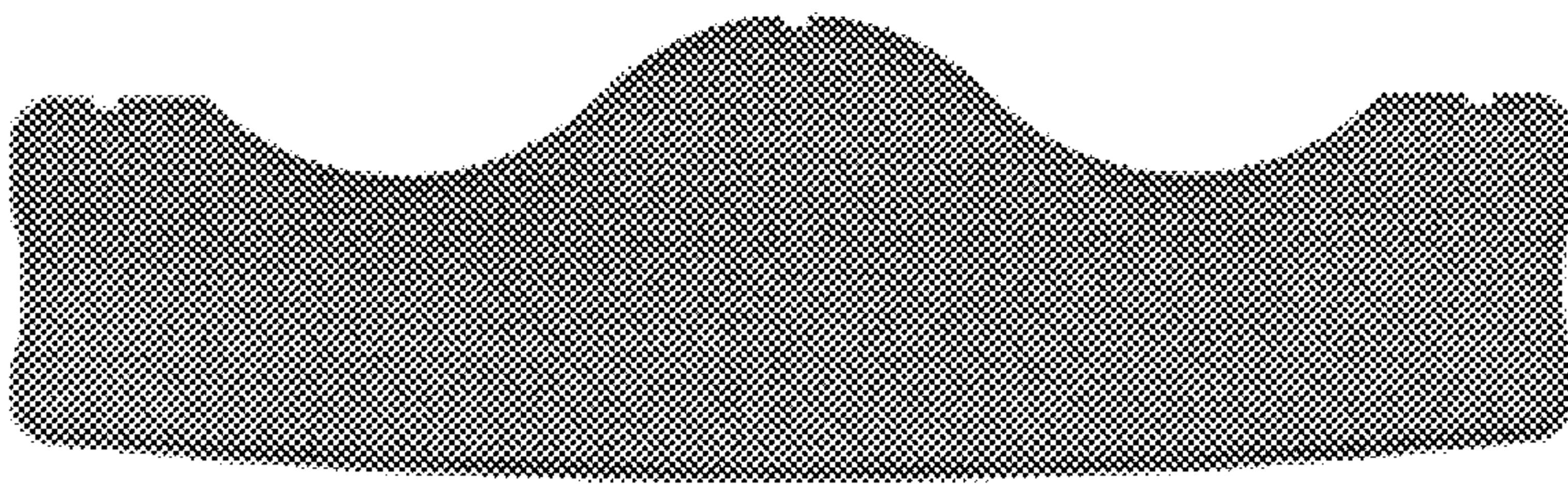

Fig. 67

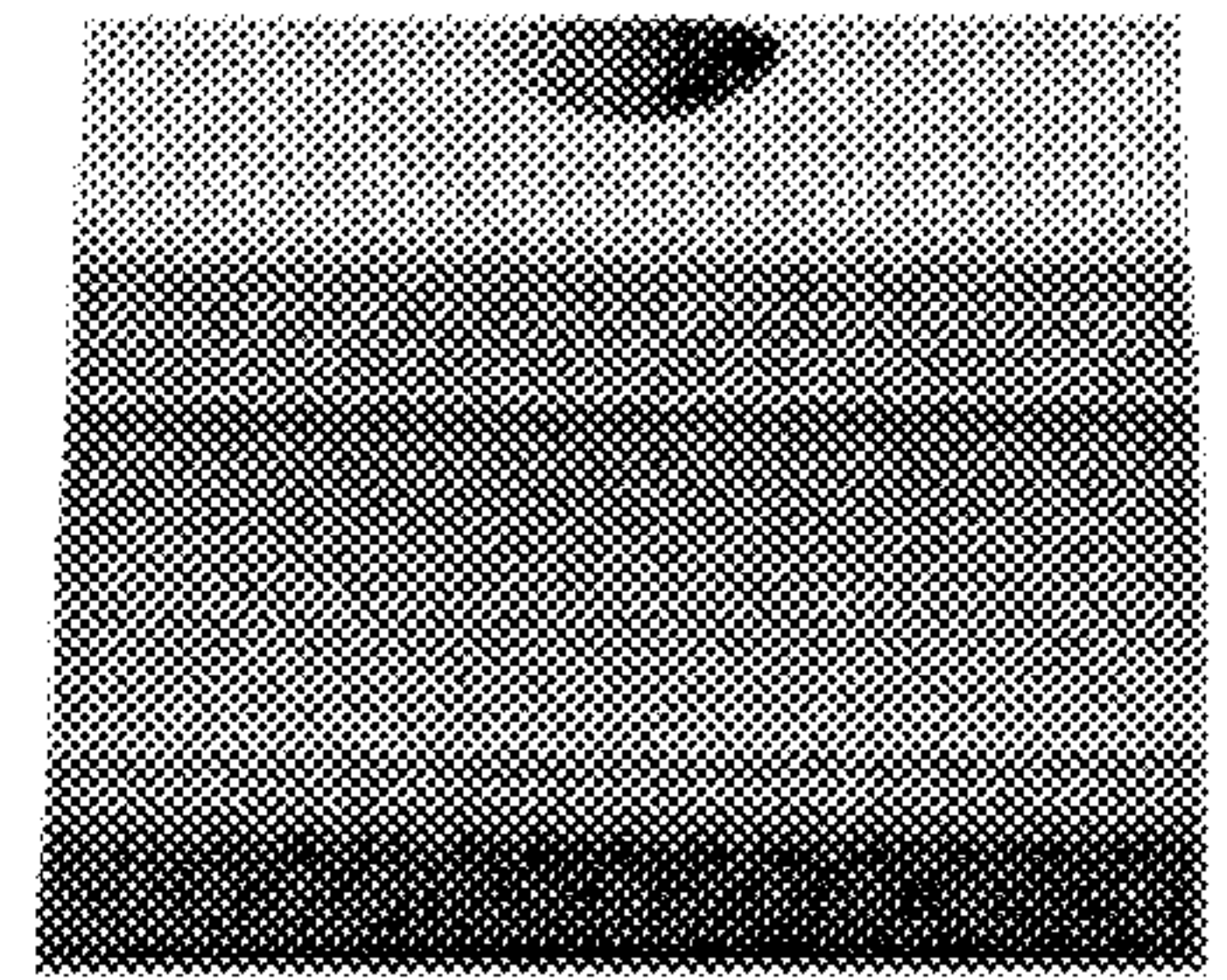

Fig. 68

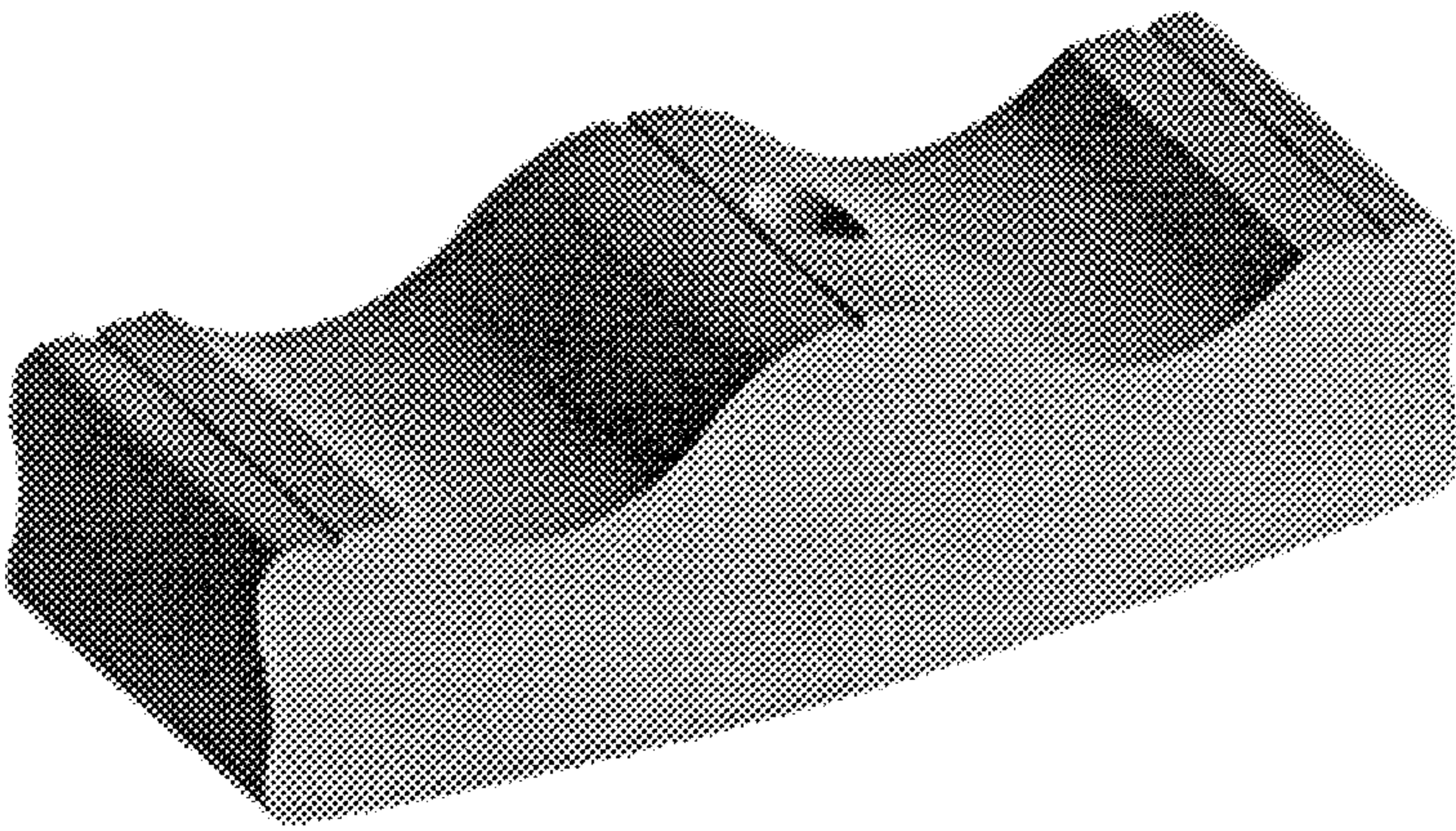

Fig. 69

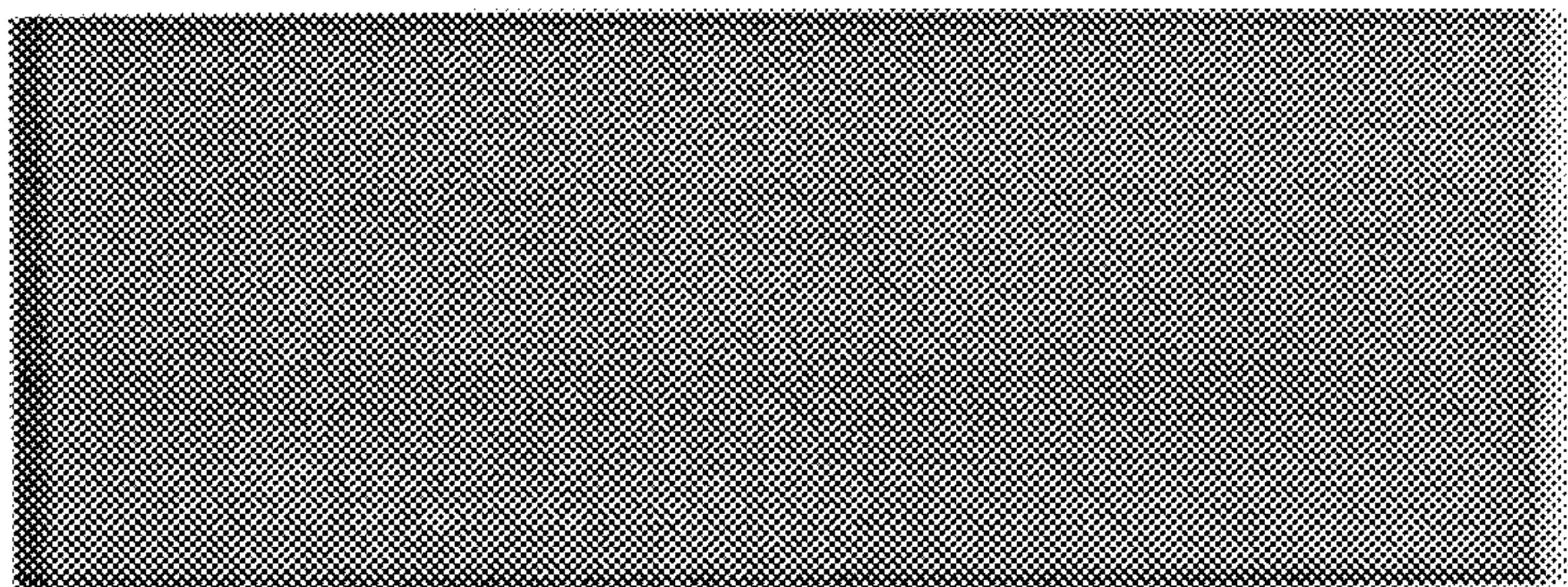

Fig. 70

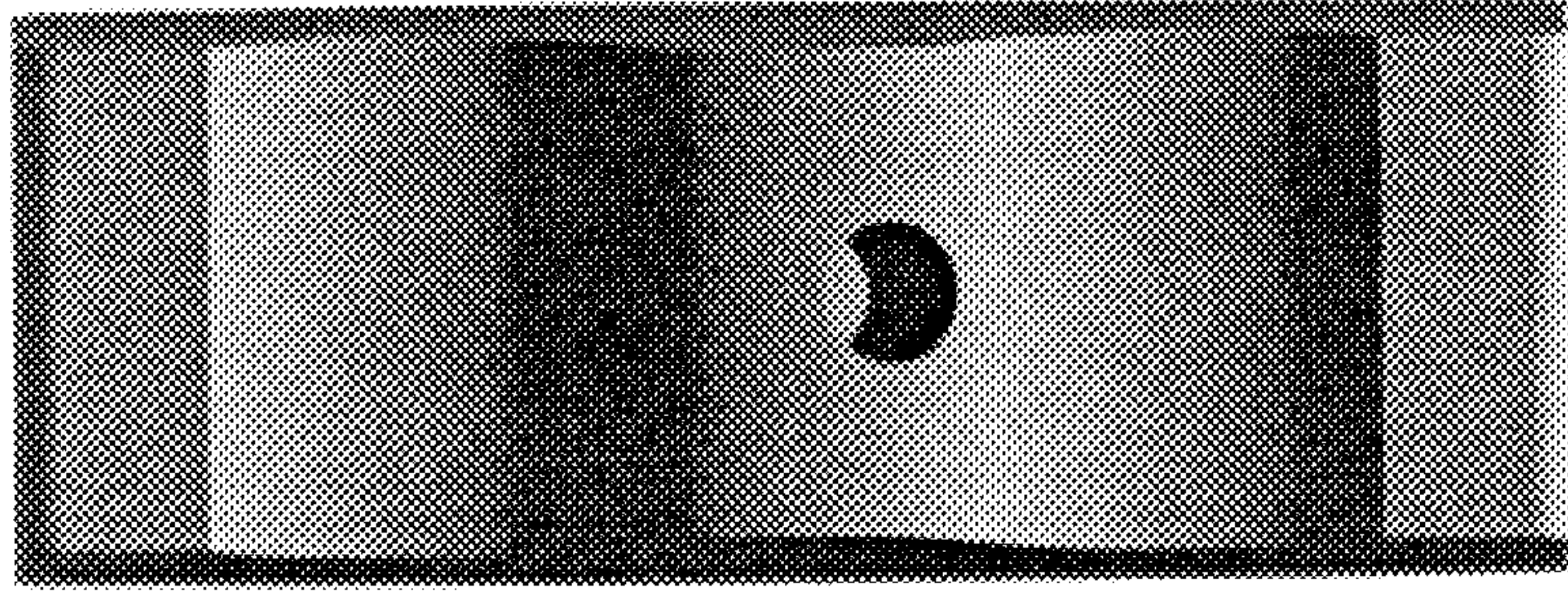

Fig. 71

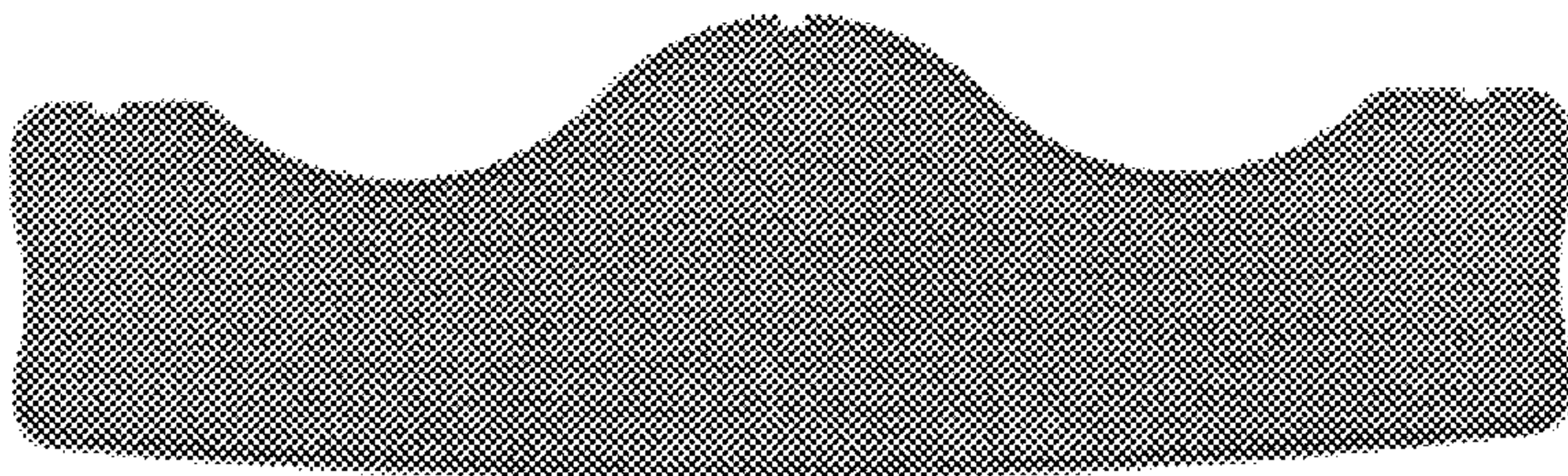

Fig. 72

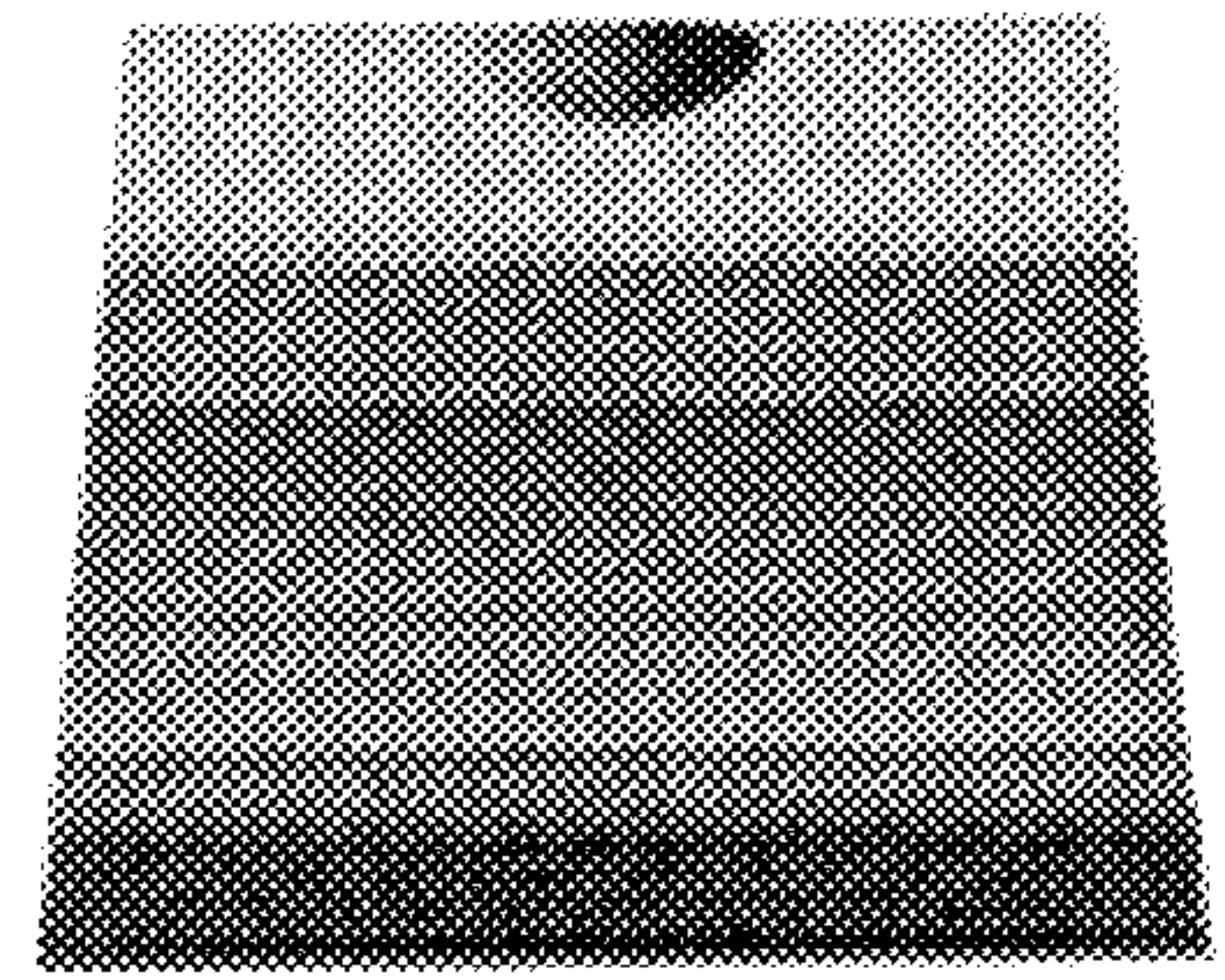

Fig. 73

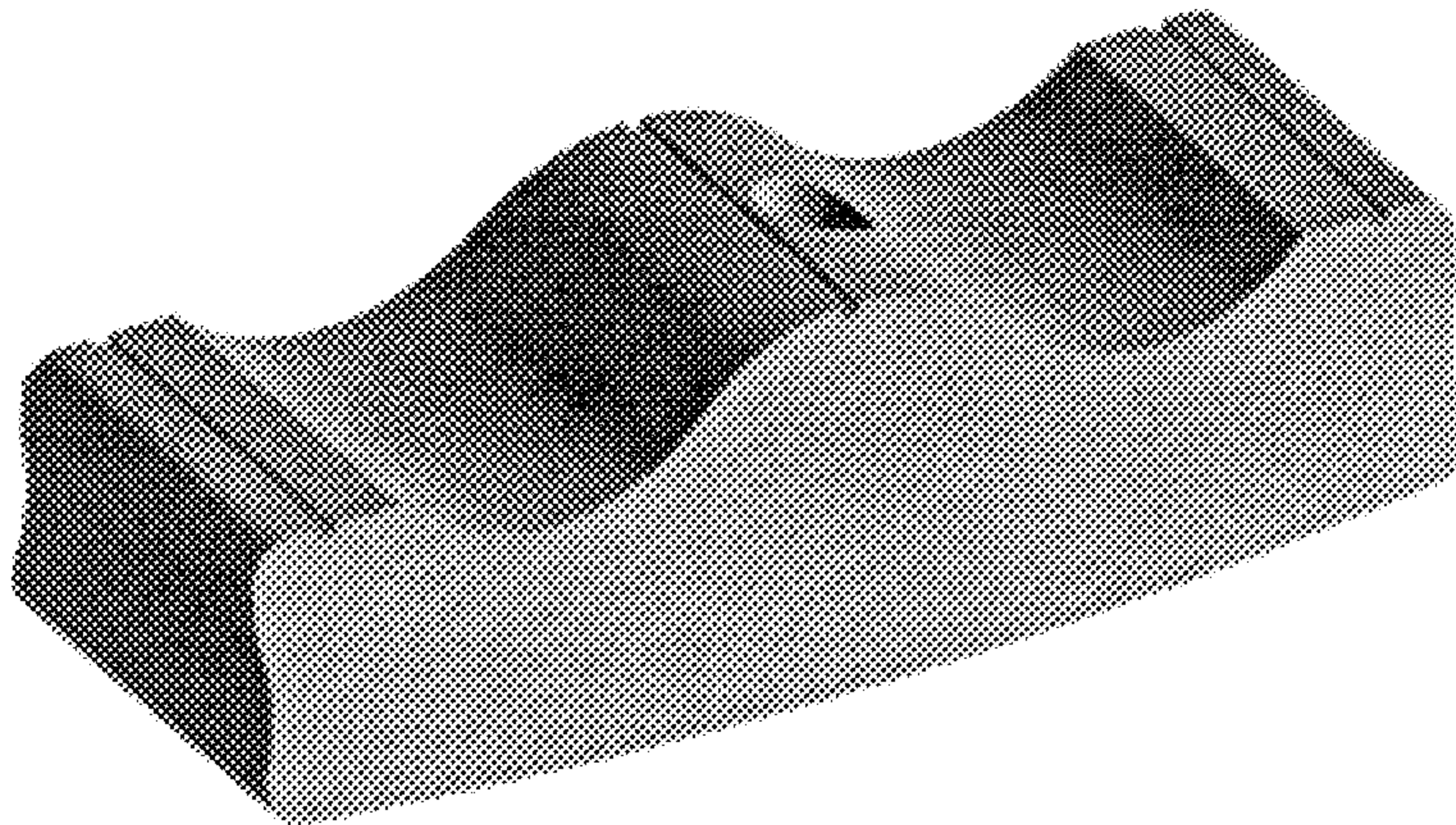

Fig. 74

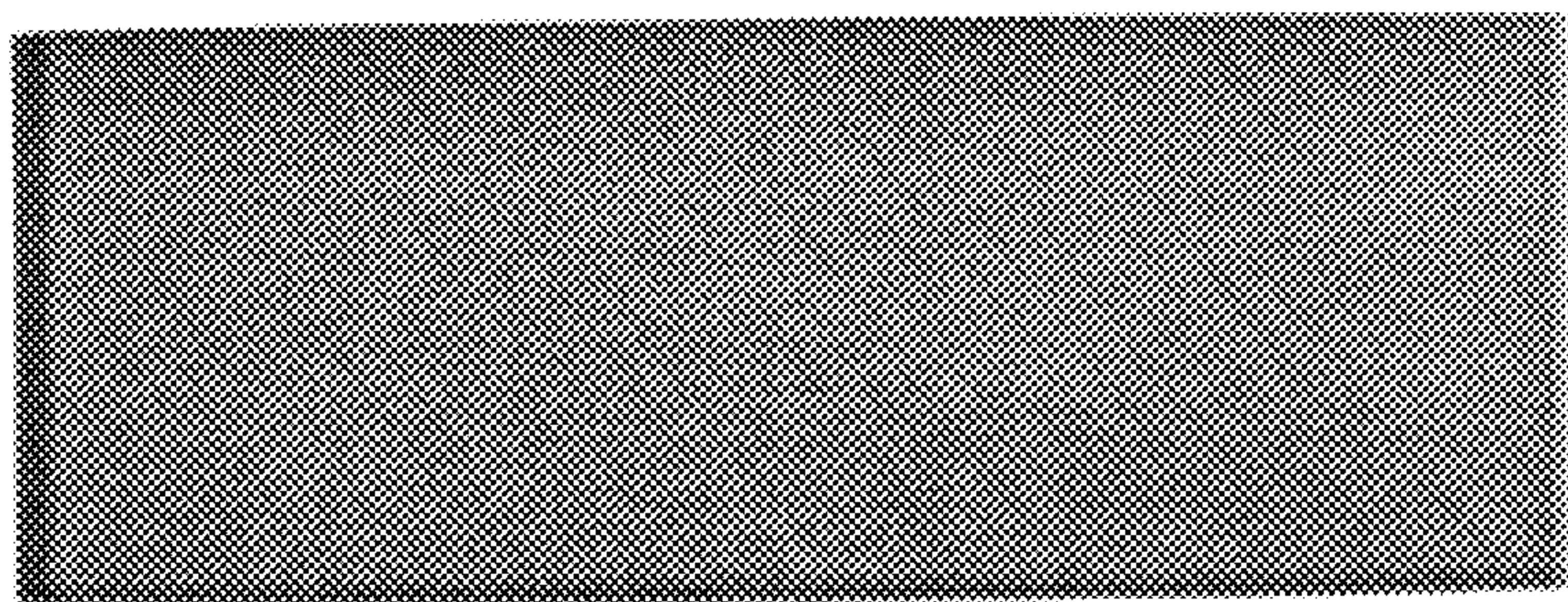

Fig. 75

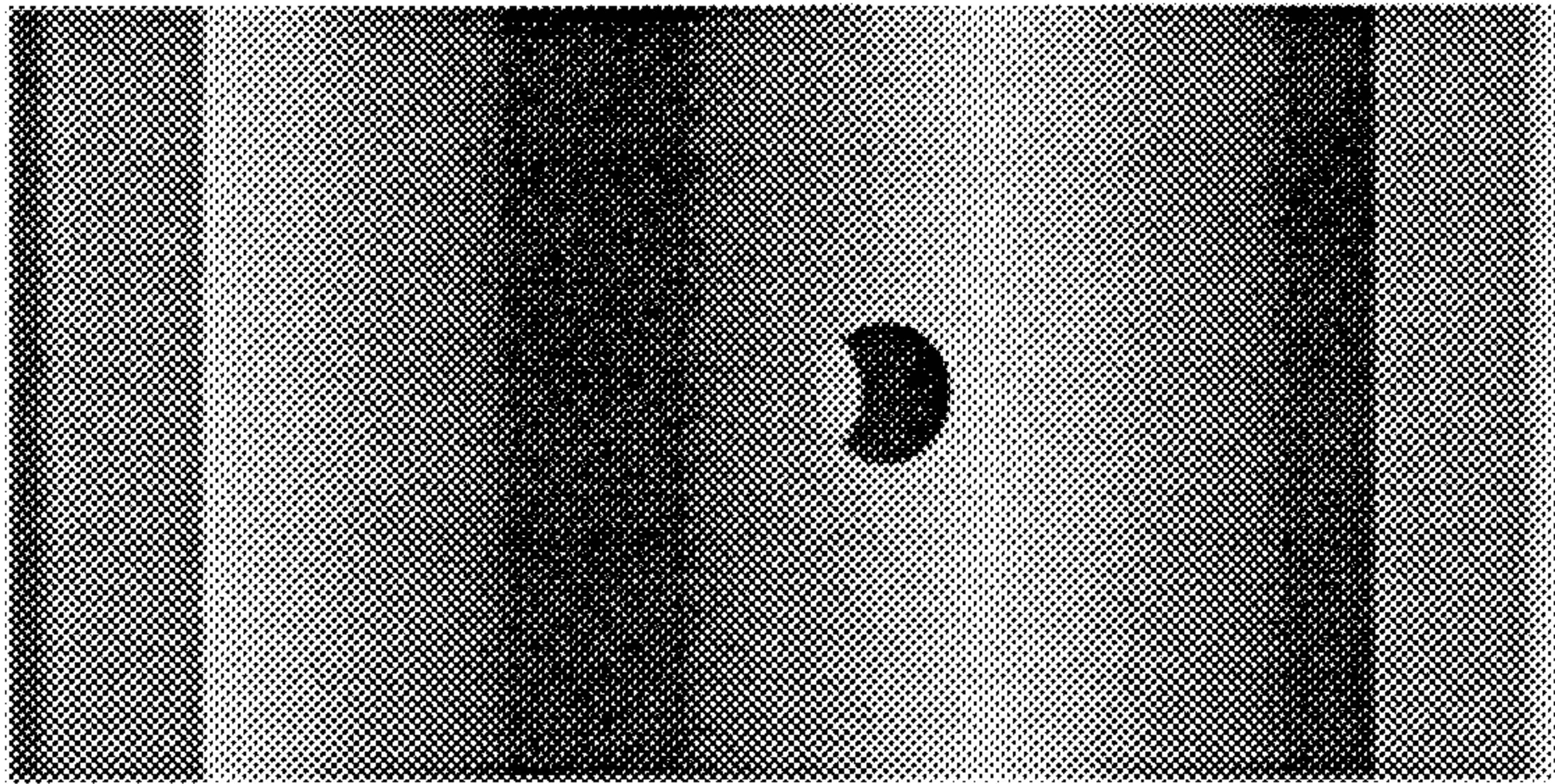

Fig. 76

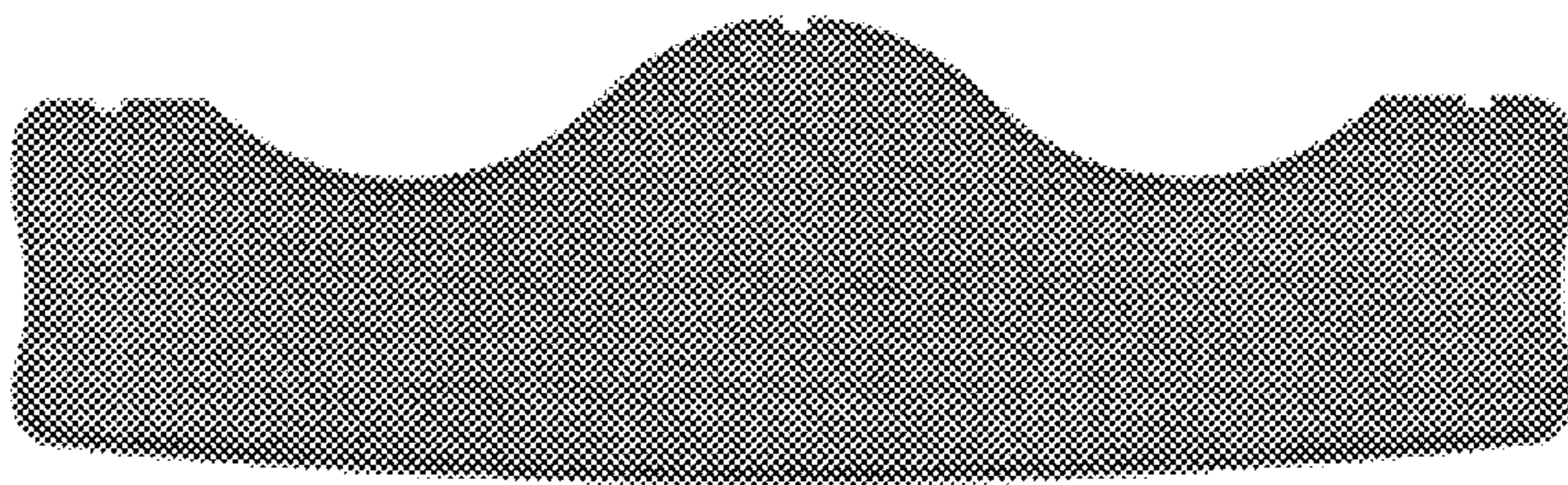

Fig. 77

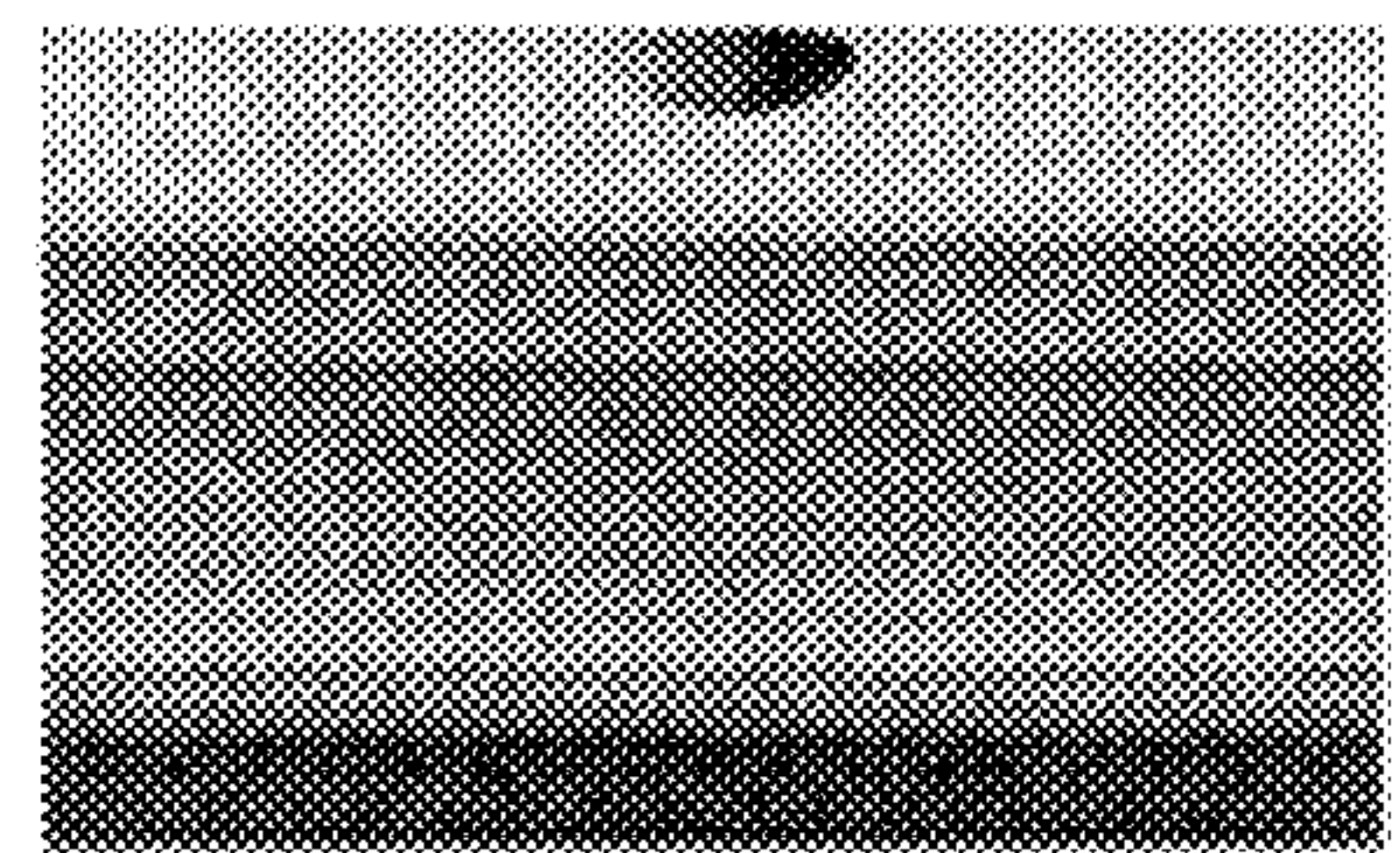

Fig. 78

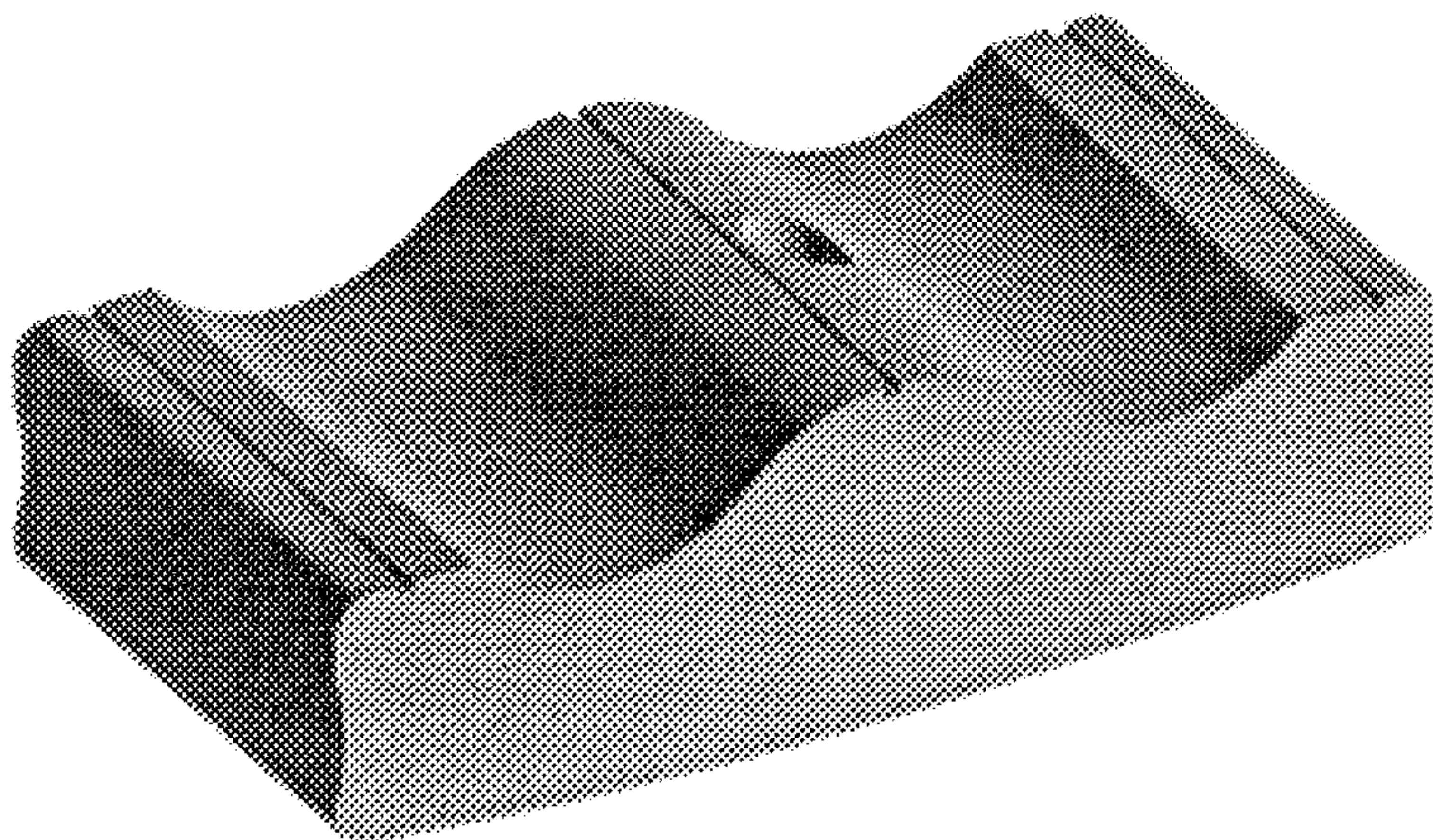

Fig. 79

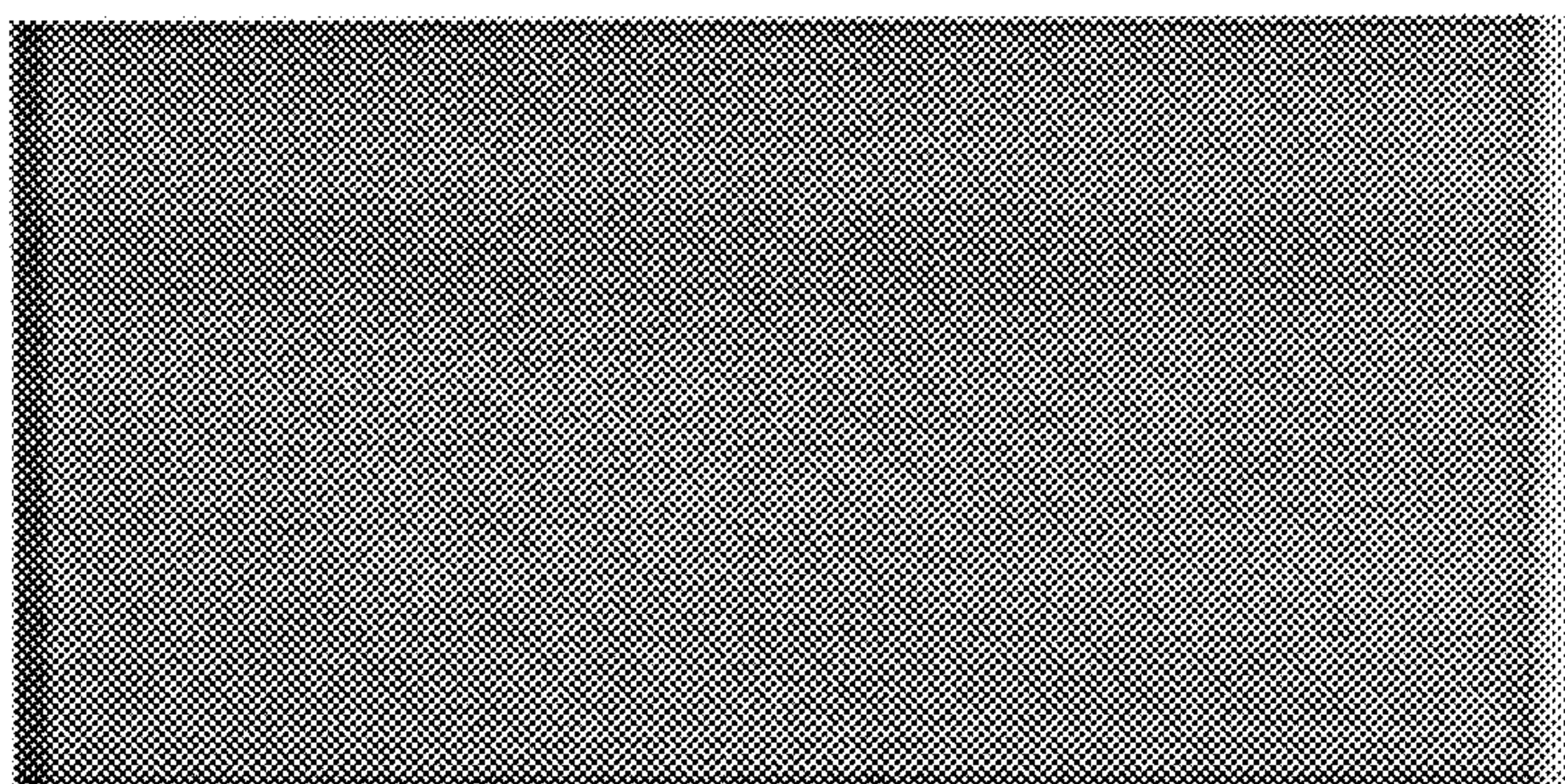

Fig. 80

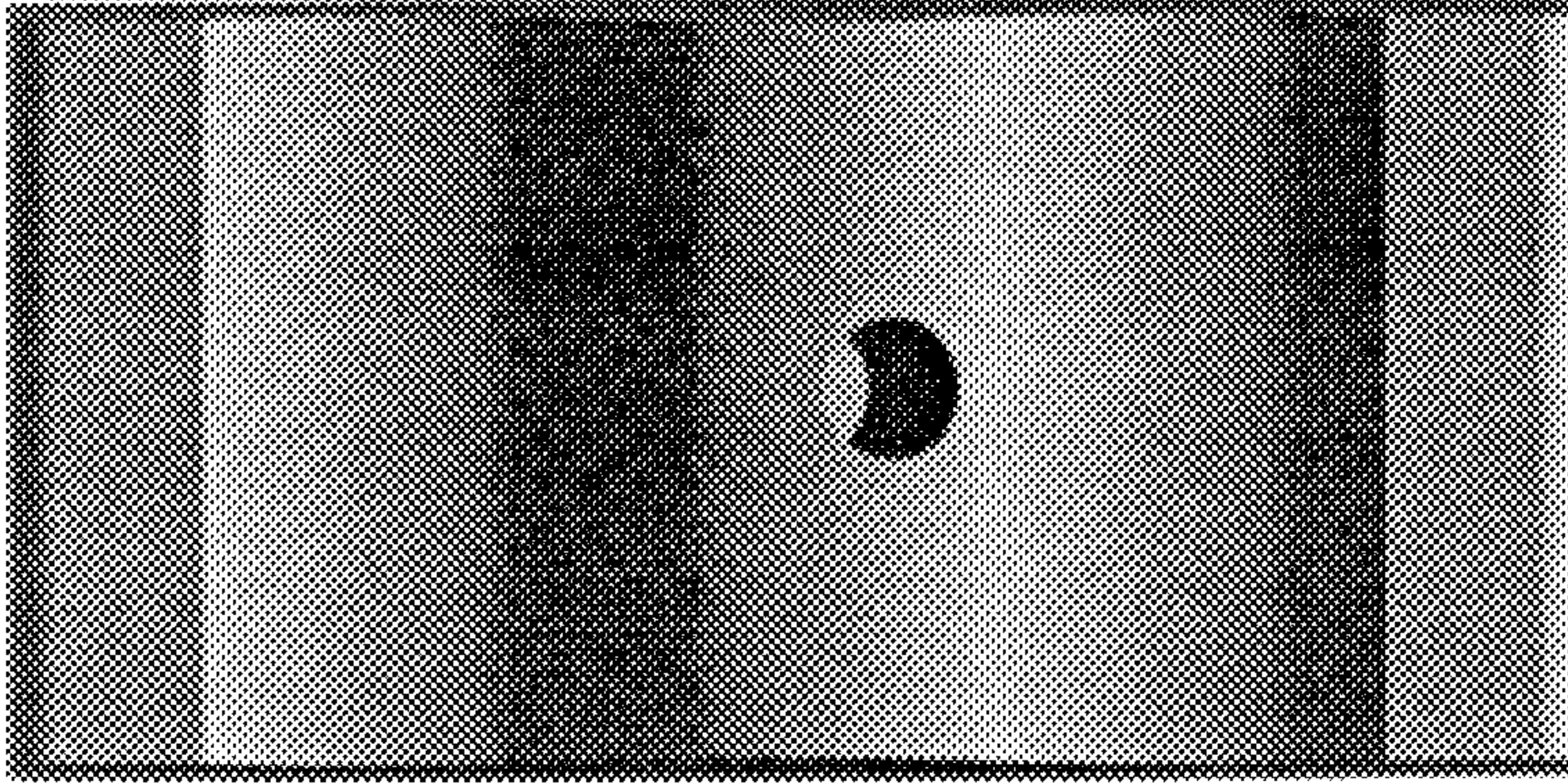

Fig. 81

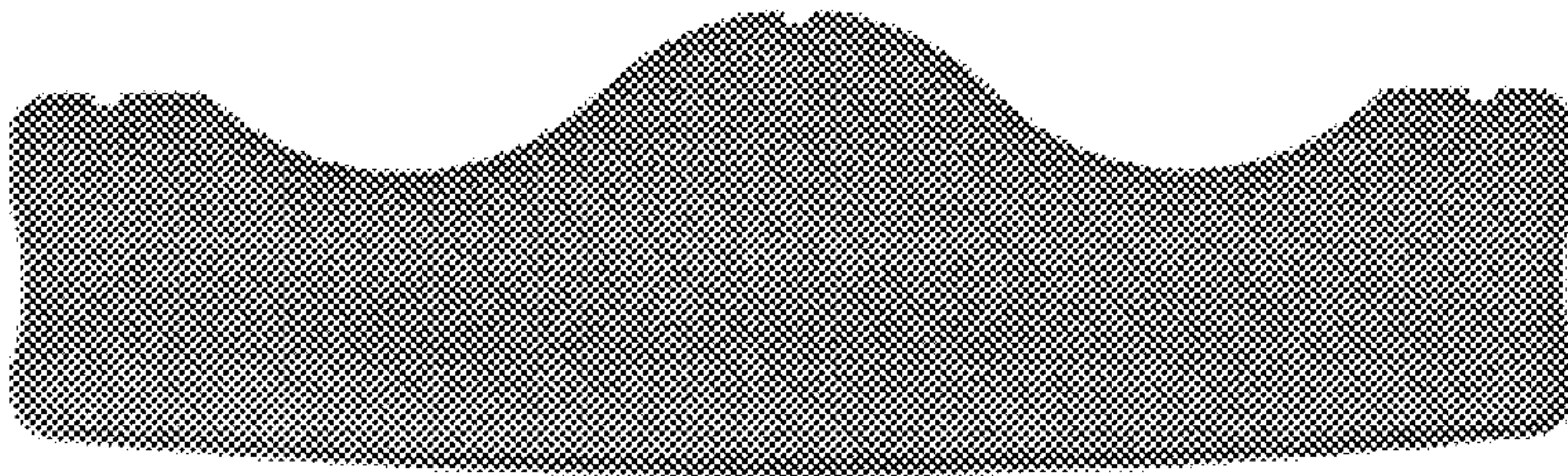

Fig. 82

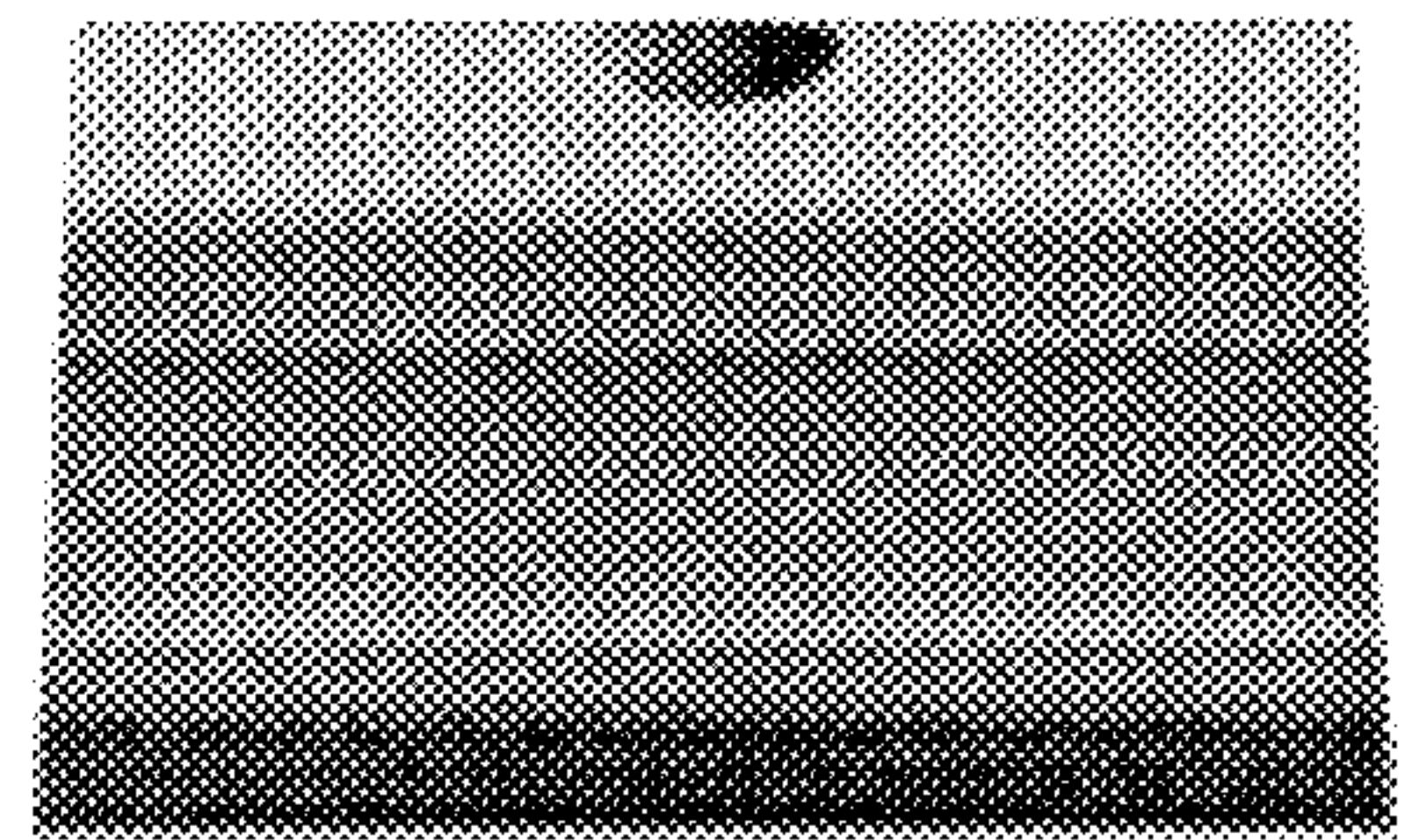

Fig. 83

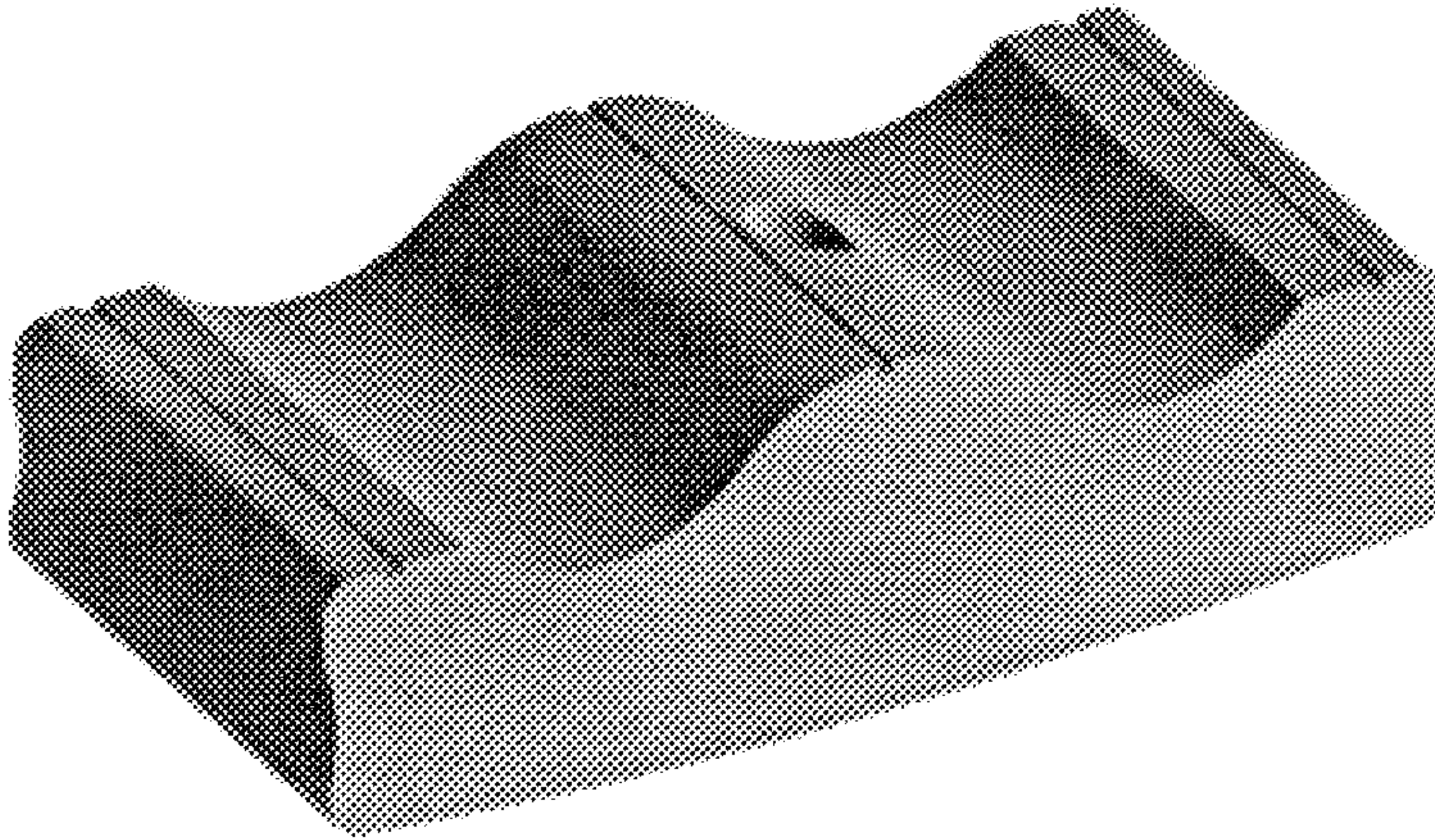

Fig. 84

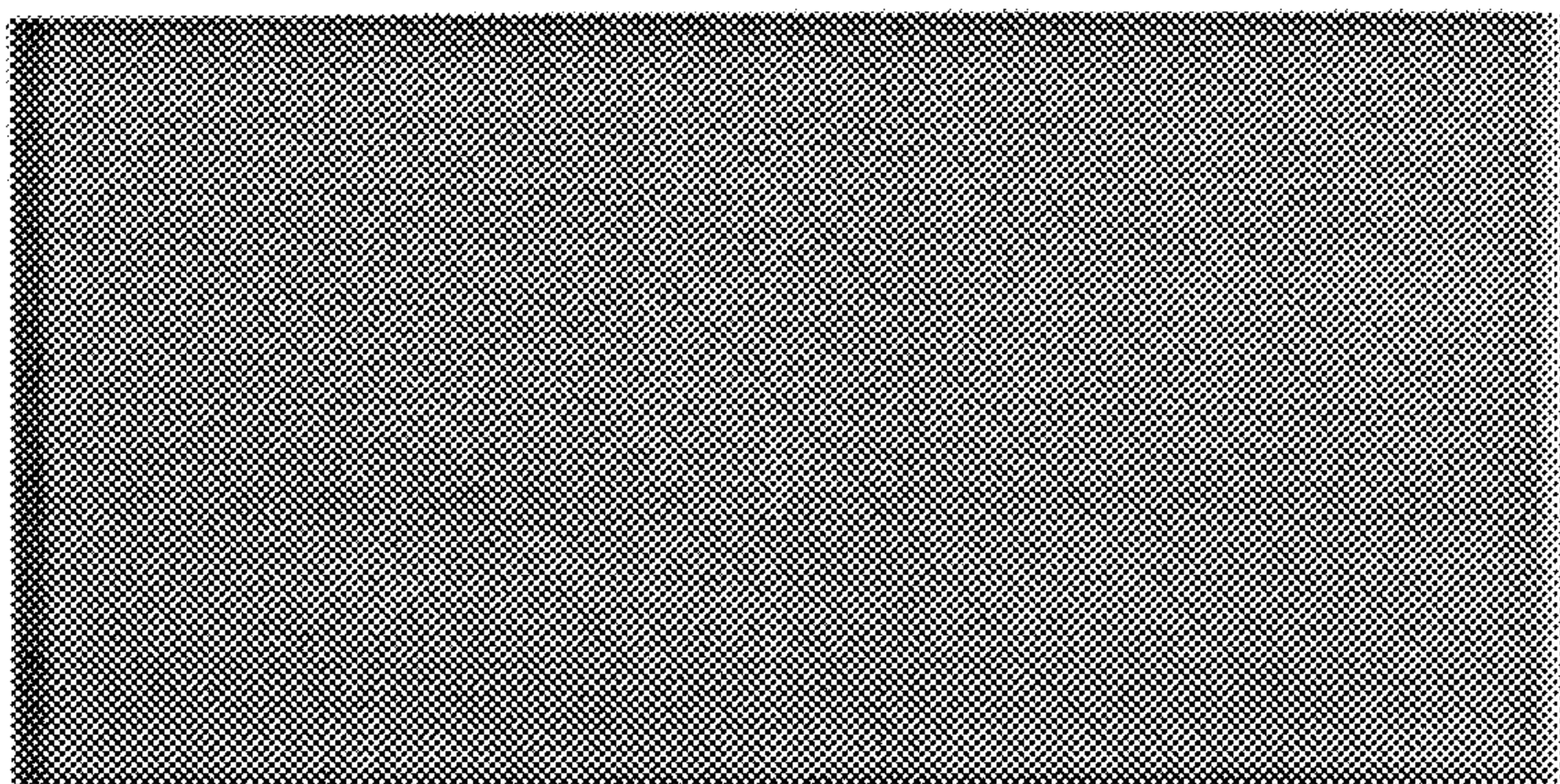

Fig. 85

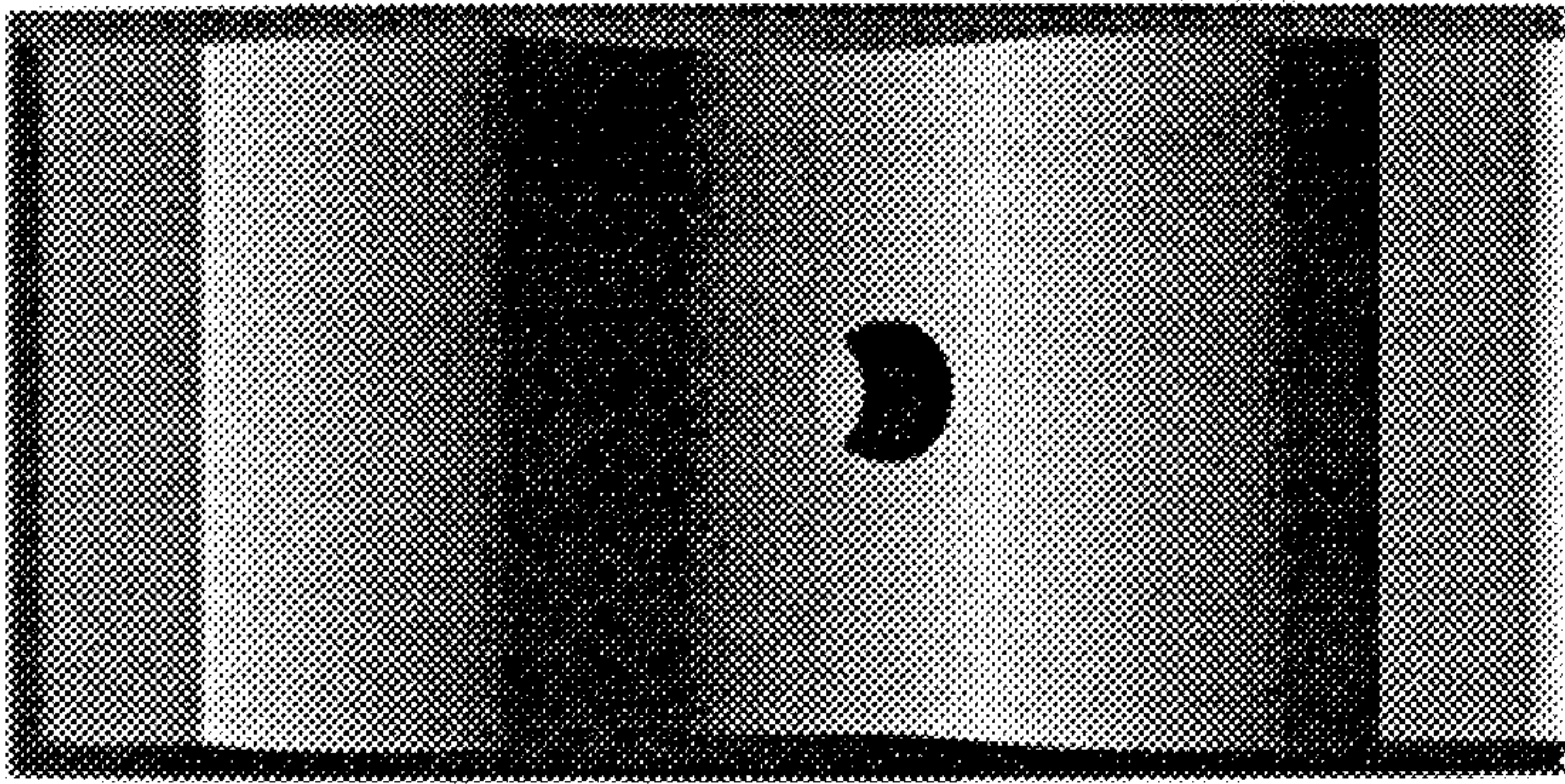

Fig. 86

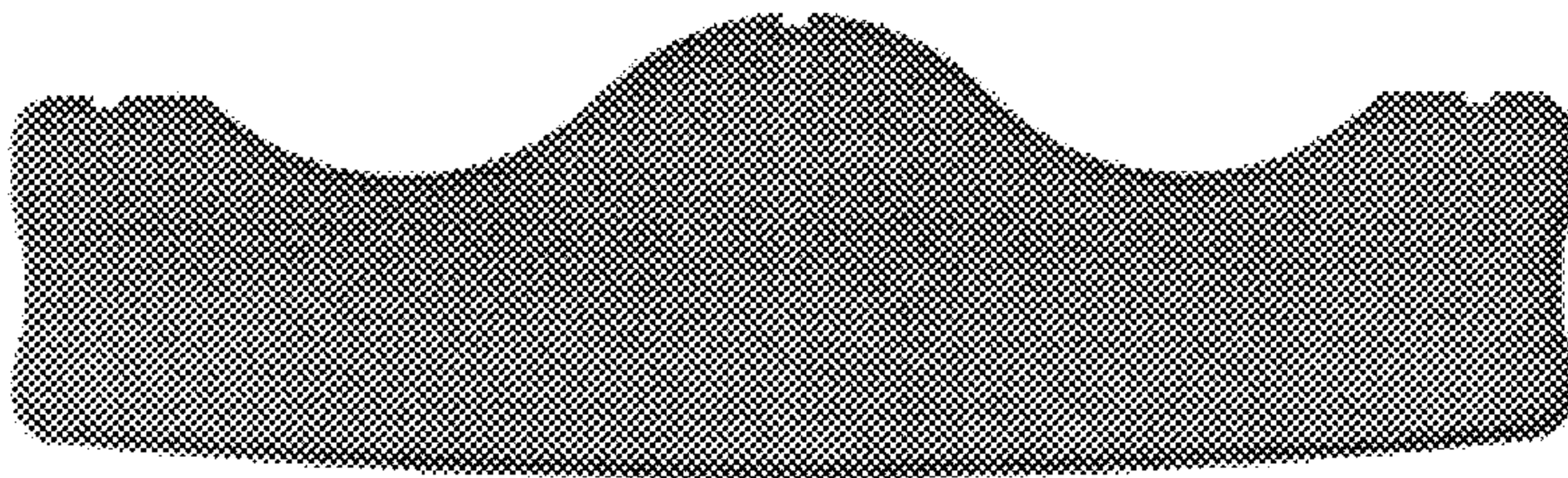

Fig. 87

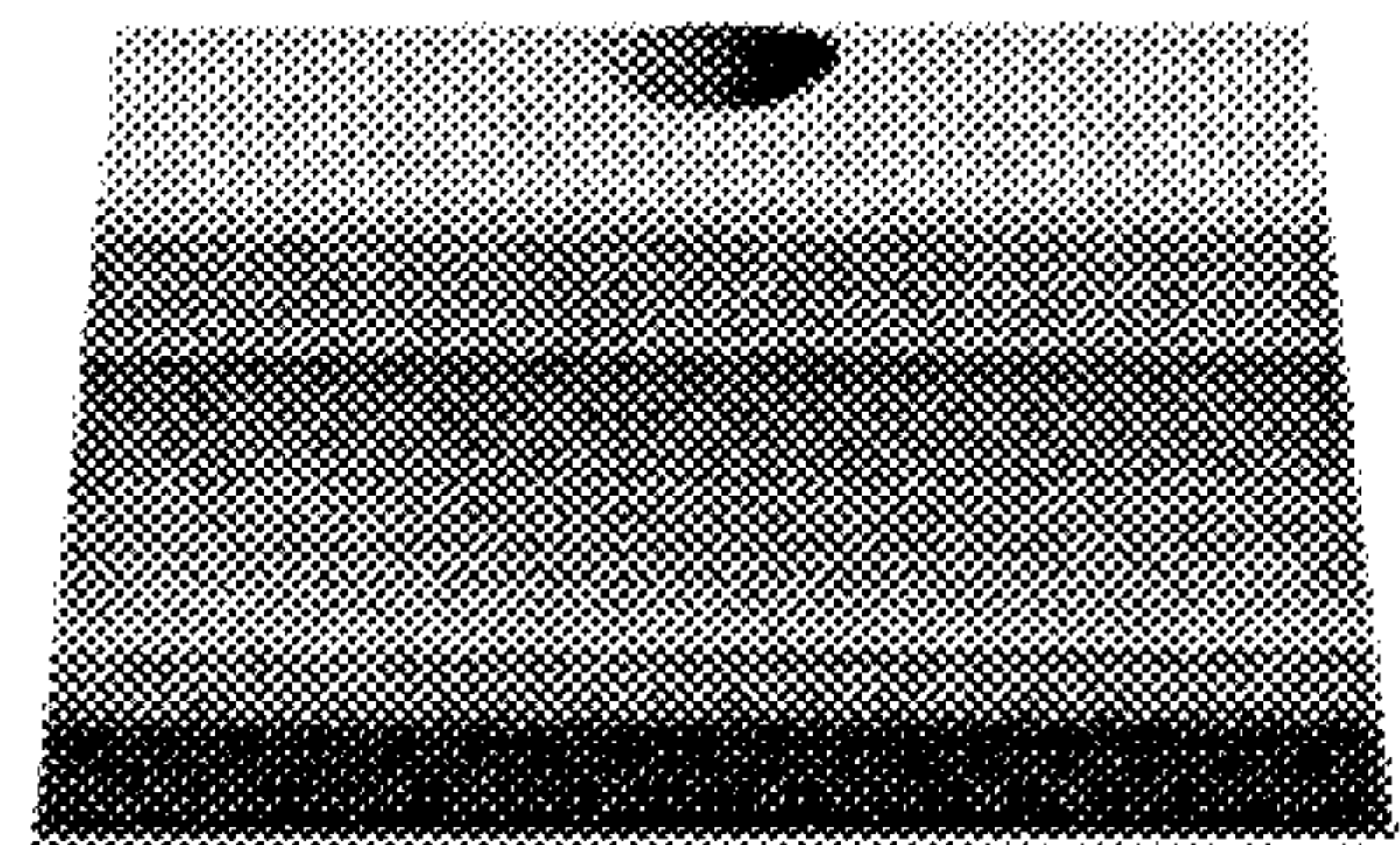

Fig. 88

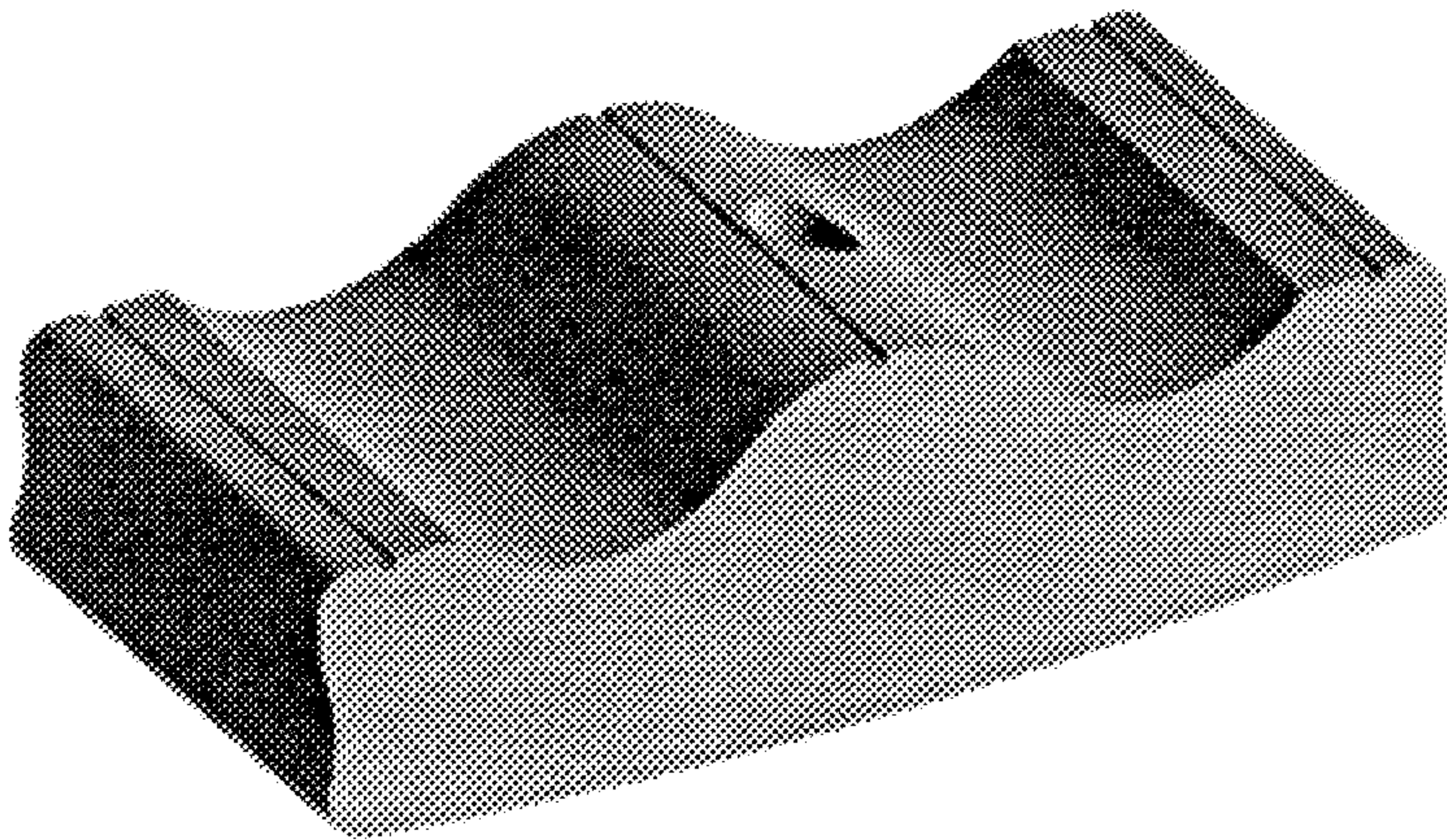

Fig. 89

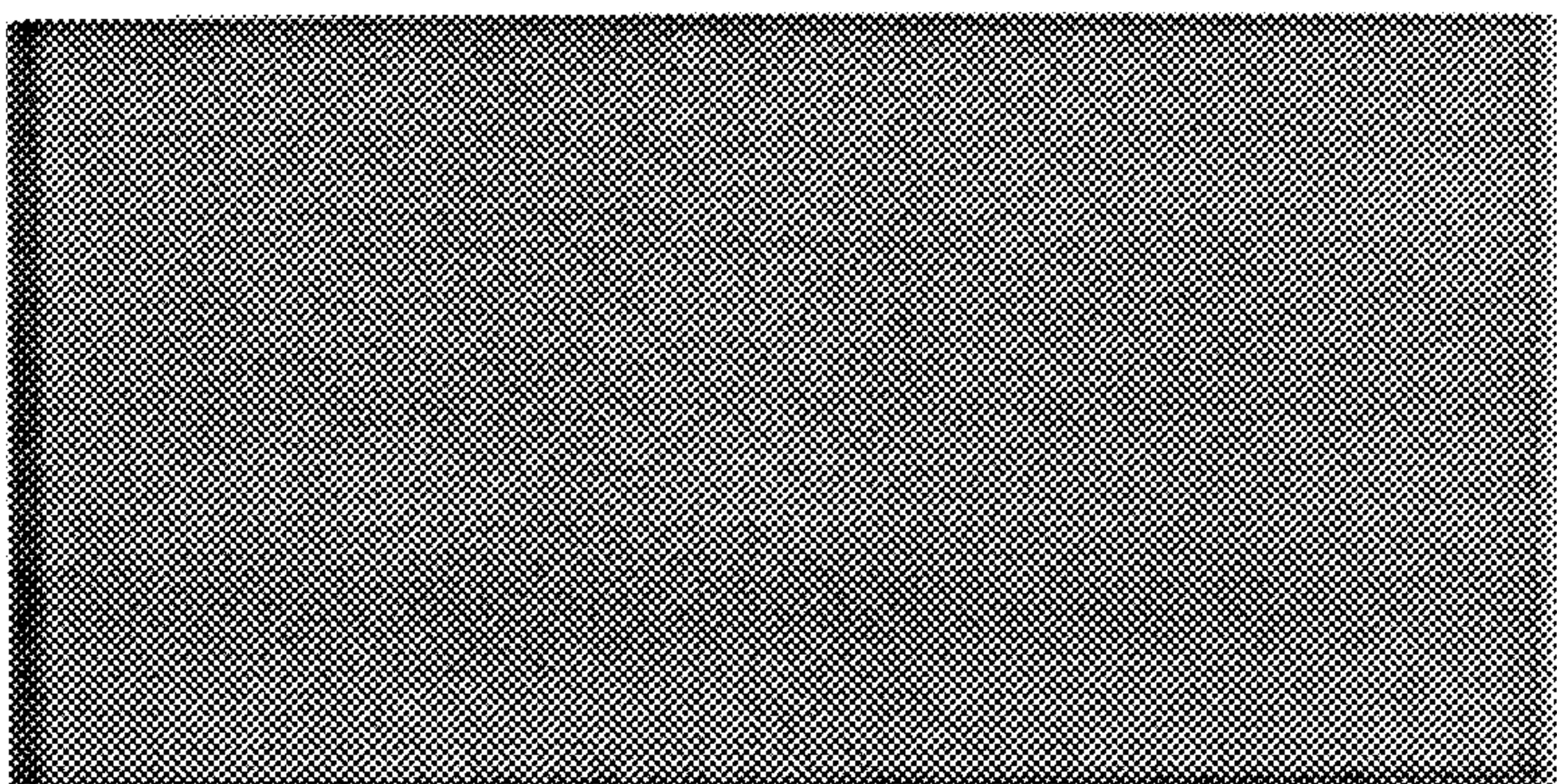

Fig. 90

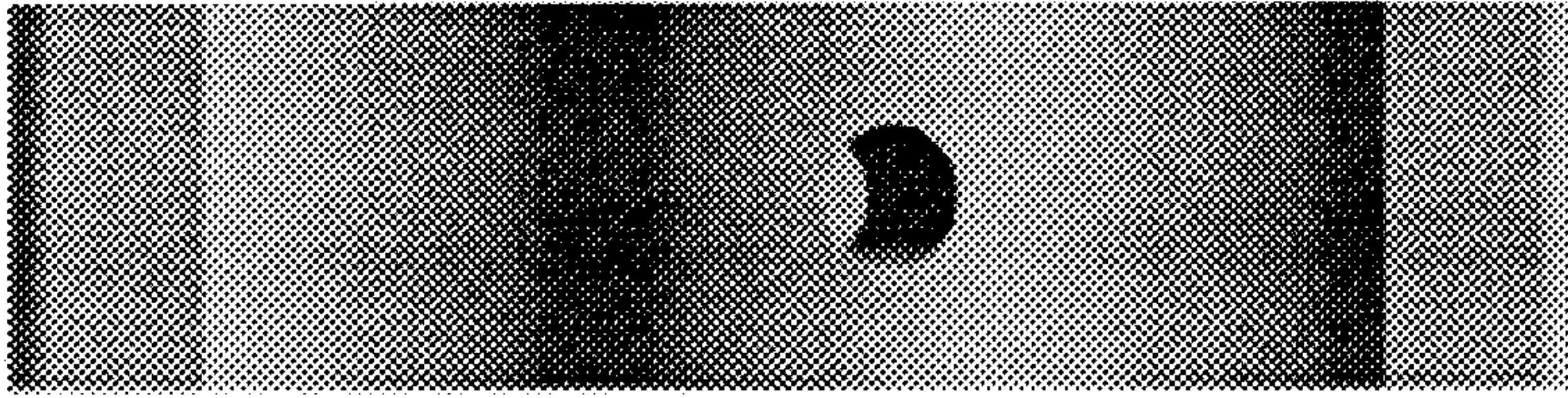

Fig. 91

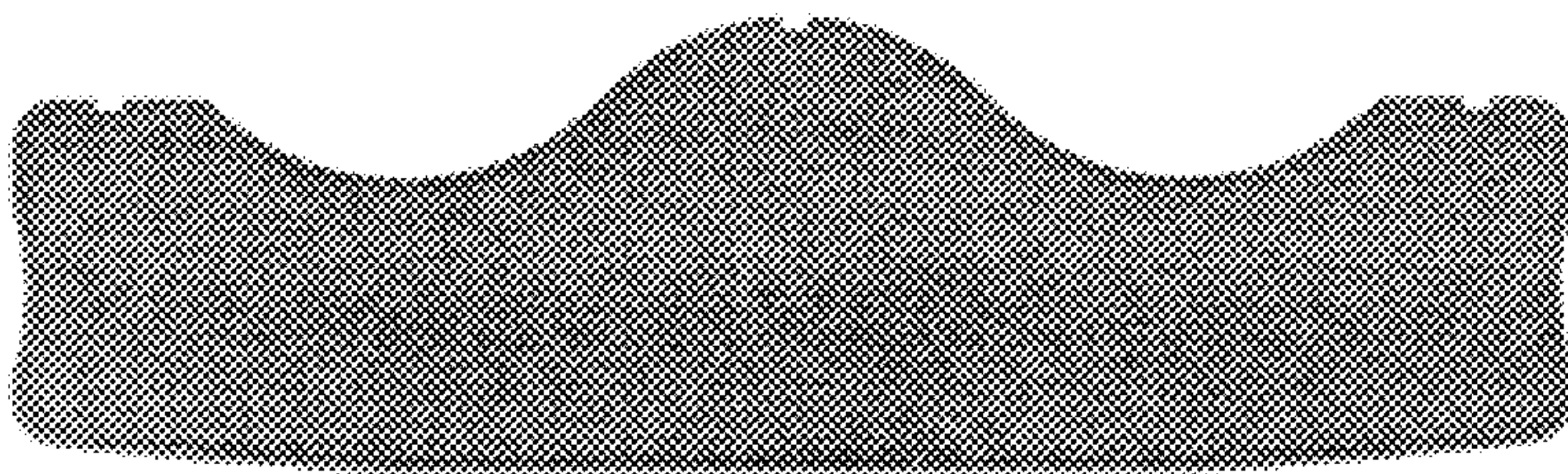

Fig. 92

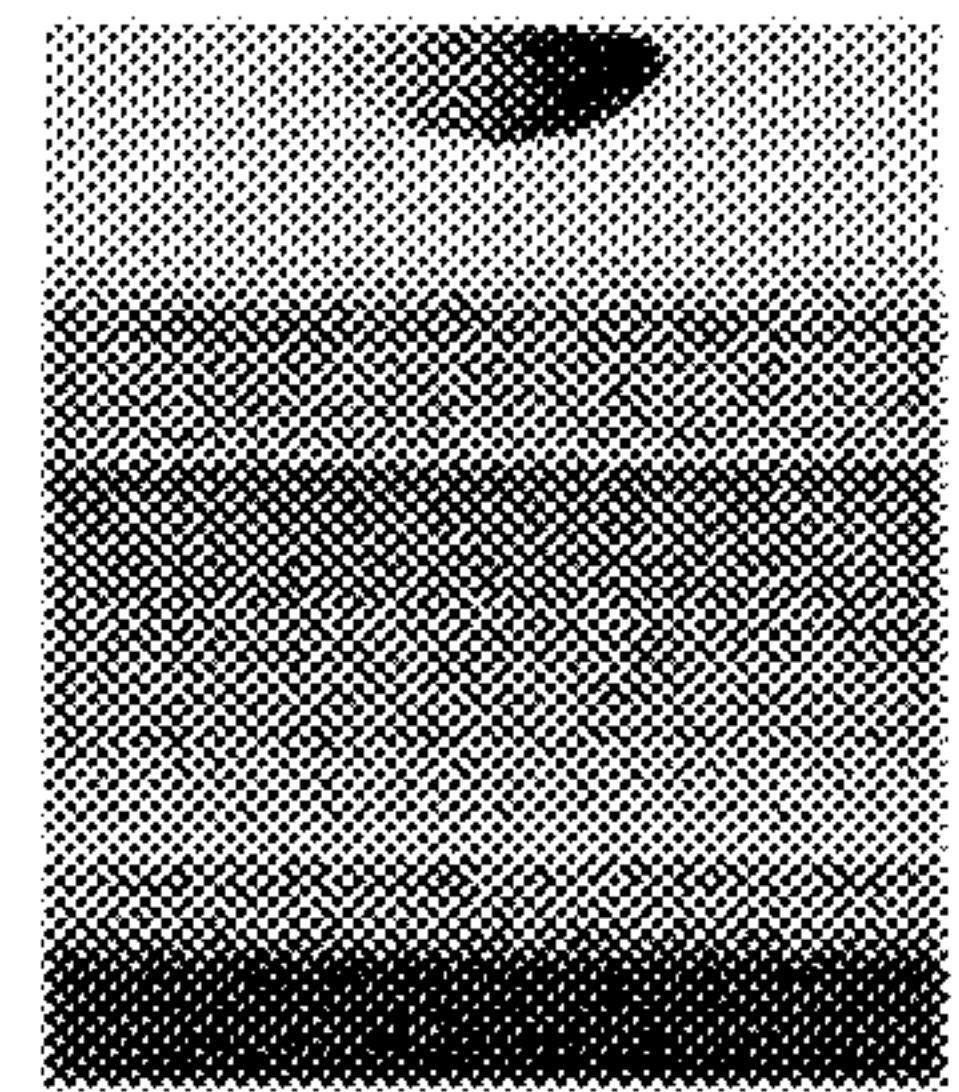

Fig. 93

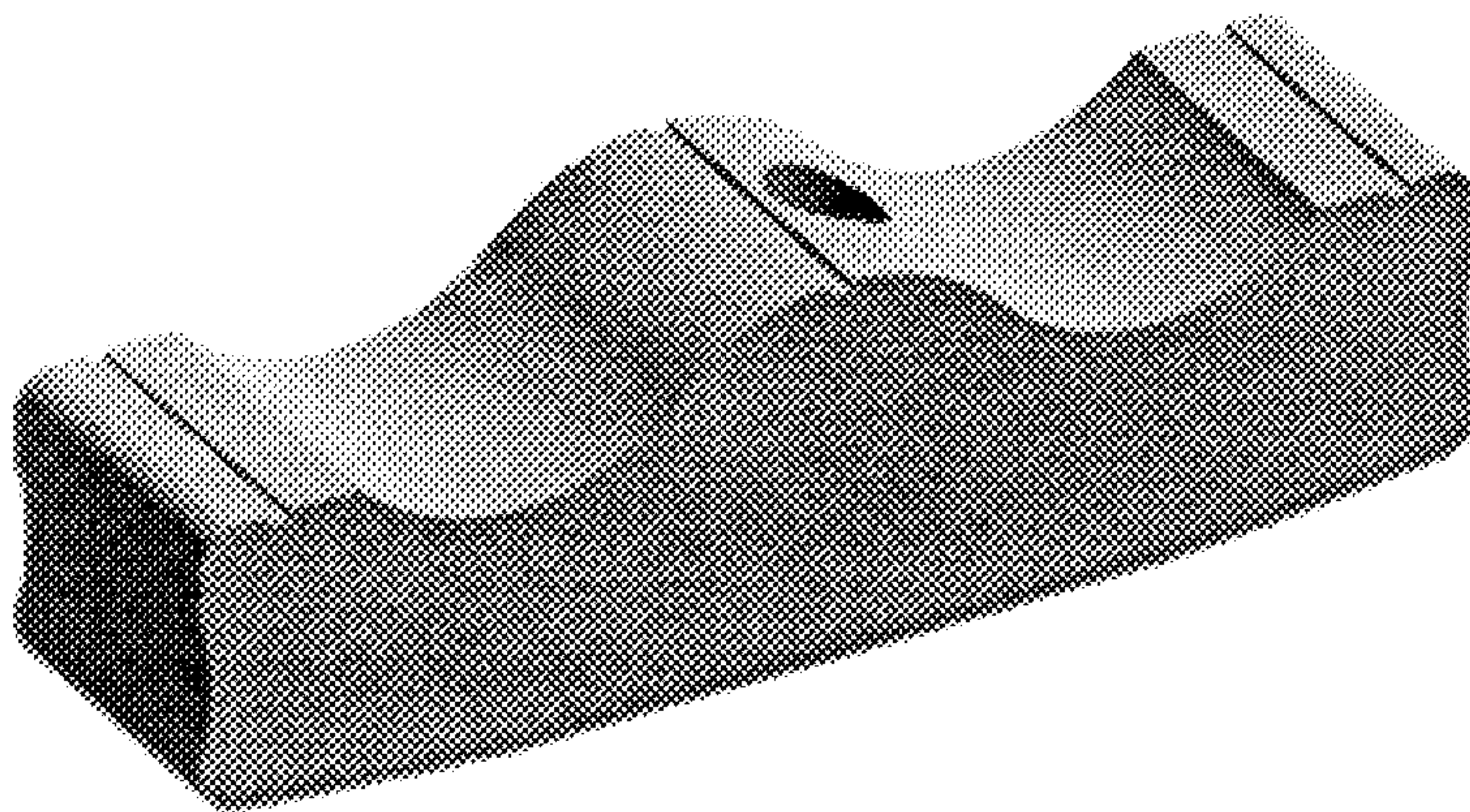

Fig. 94

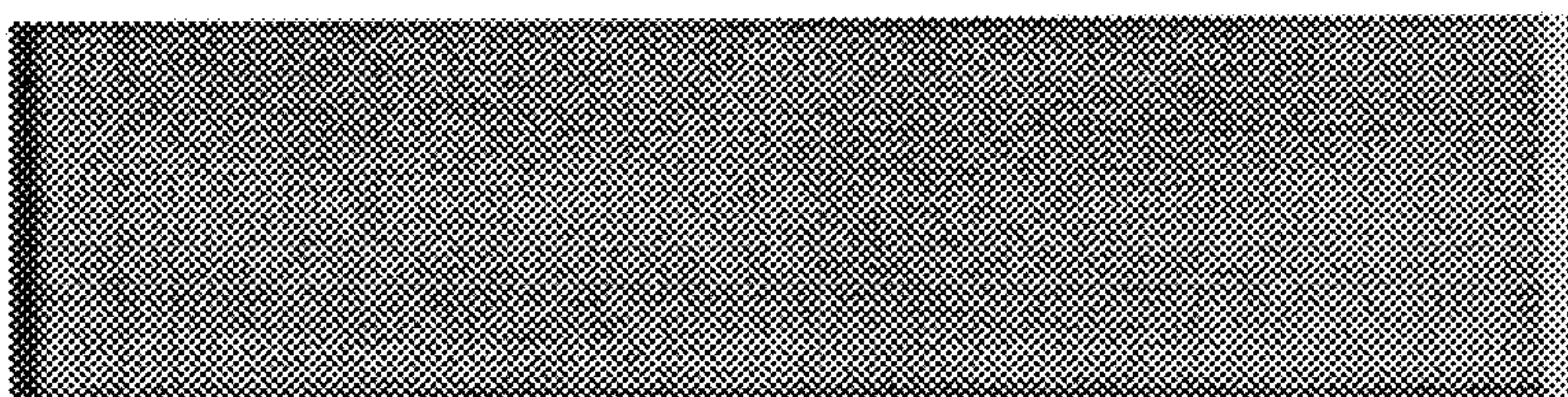

Fig. 95

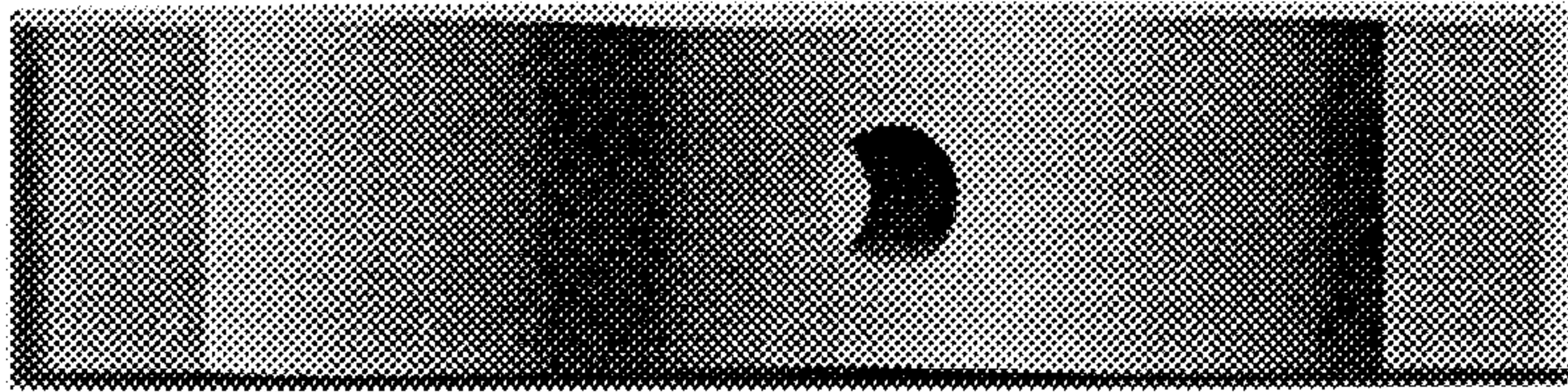

Fig. 96

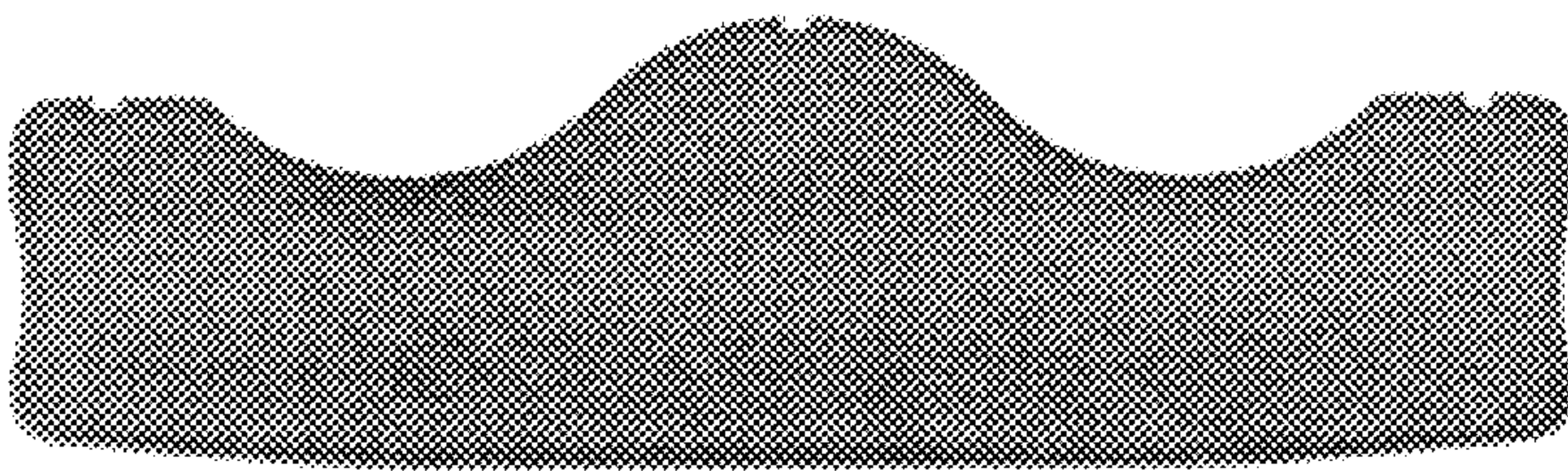

Fig. 97

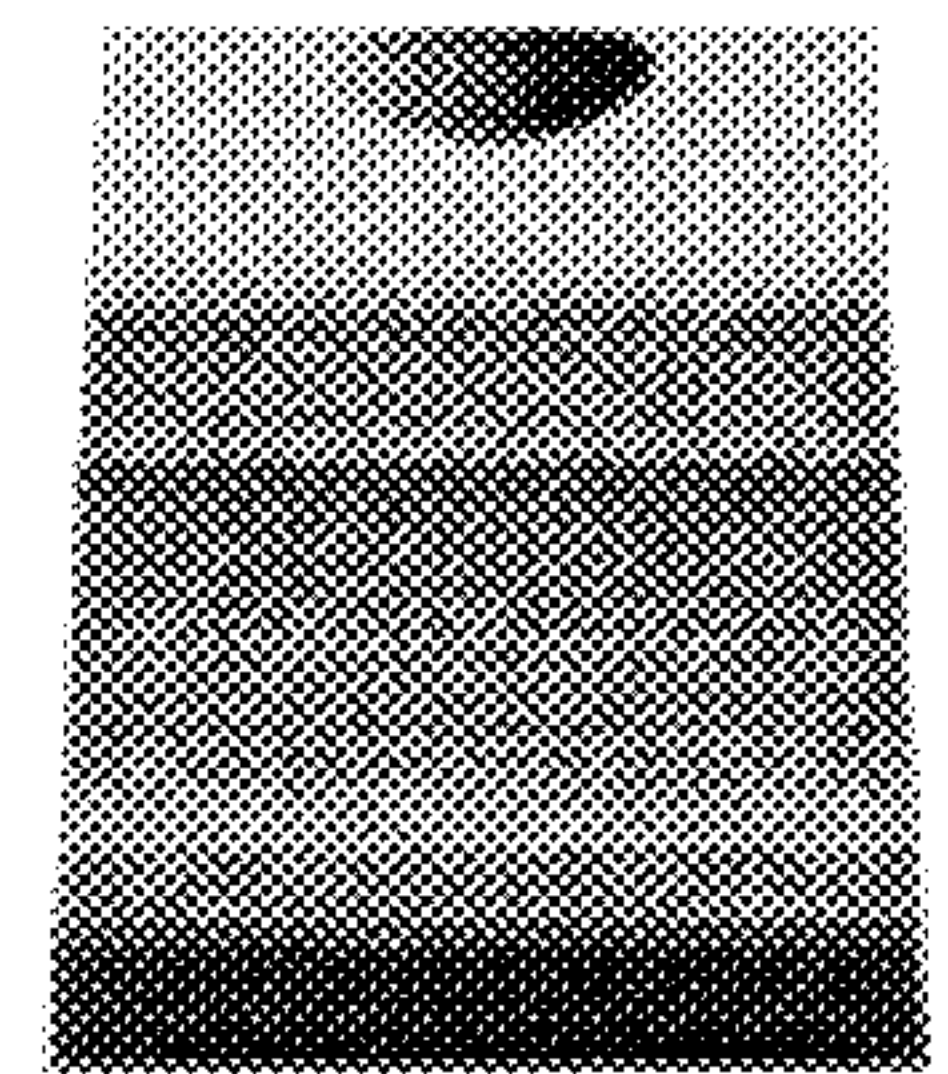

Fig. 98

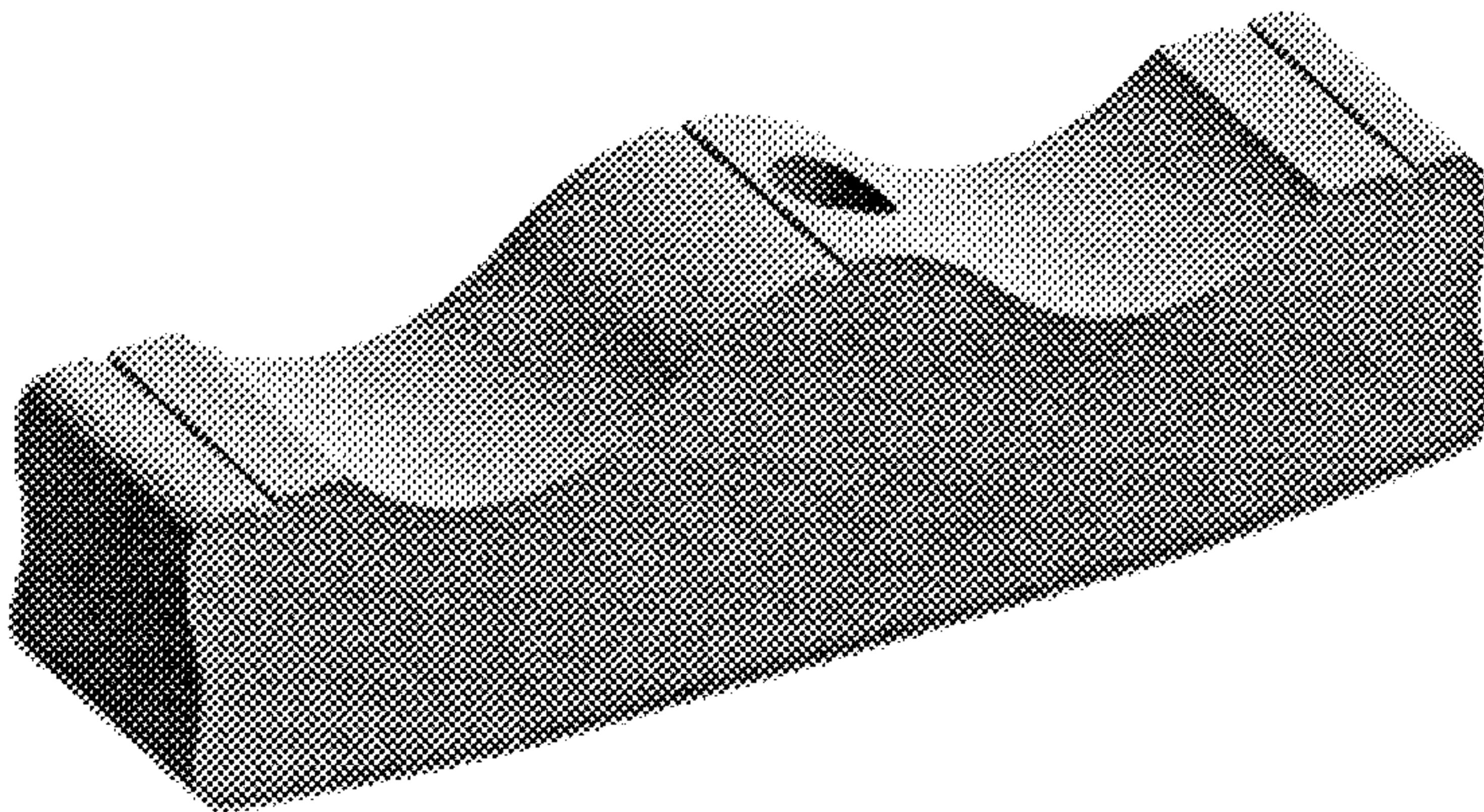

Fig. 99

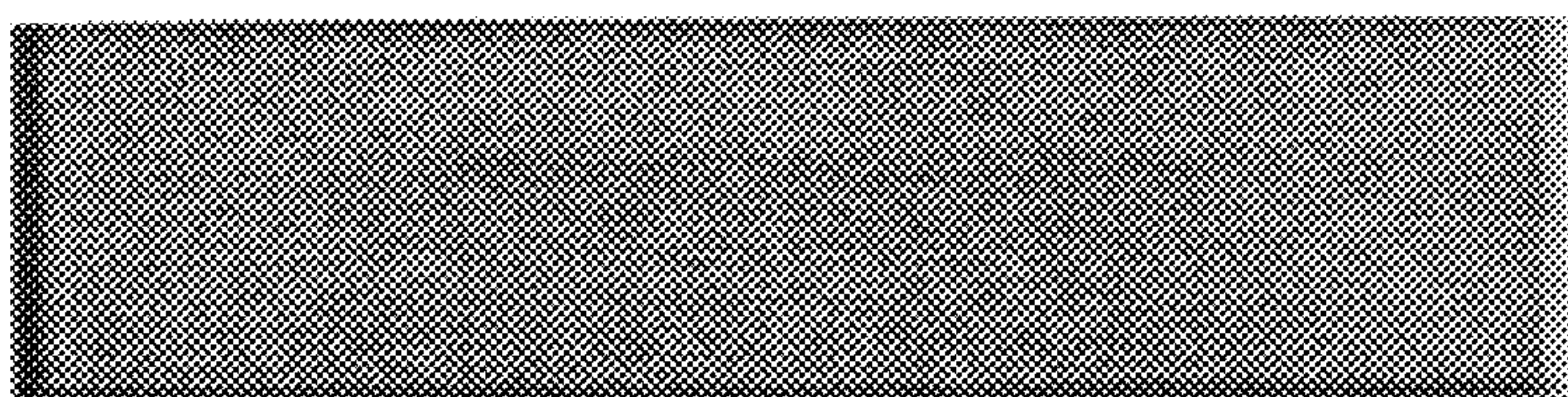

Fig. 100

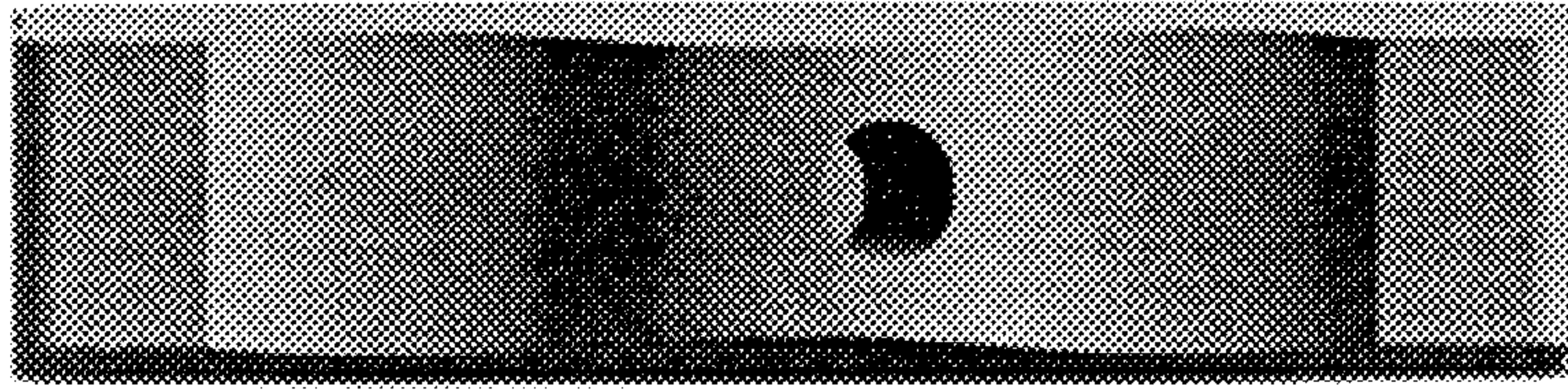

Fig. 101

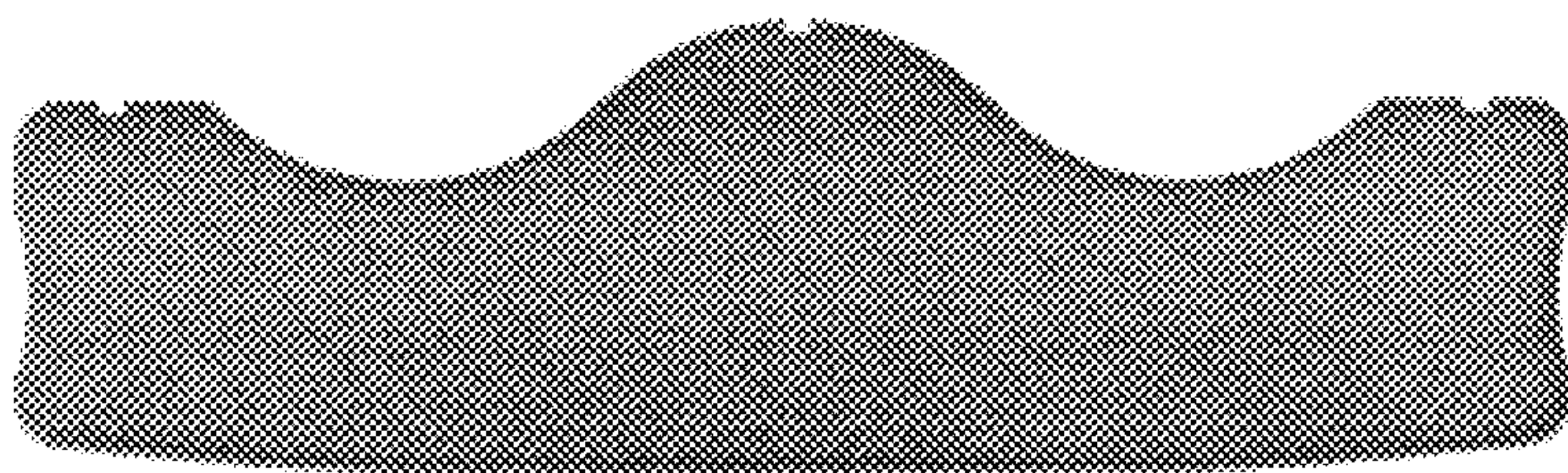

Fig. 102

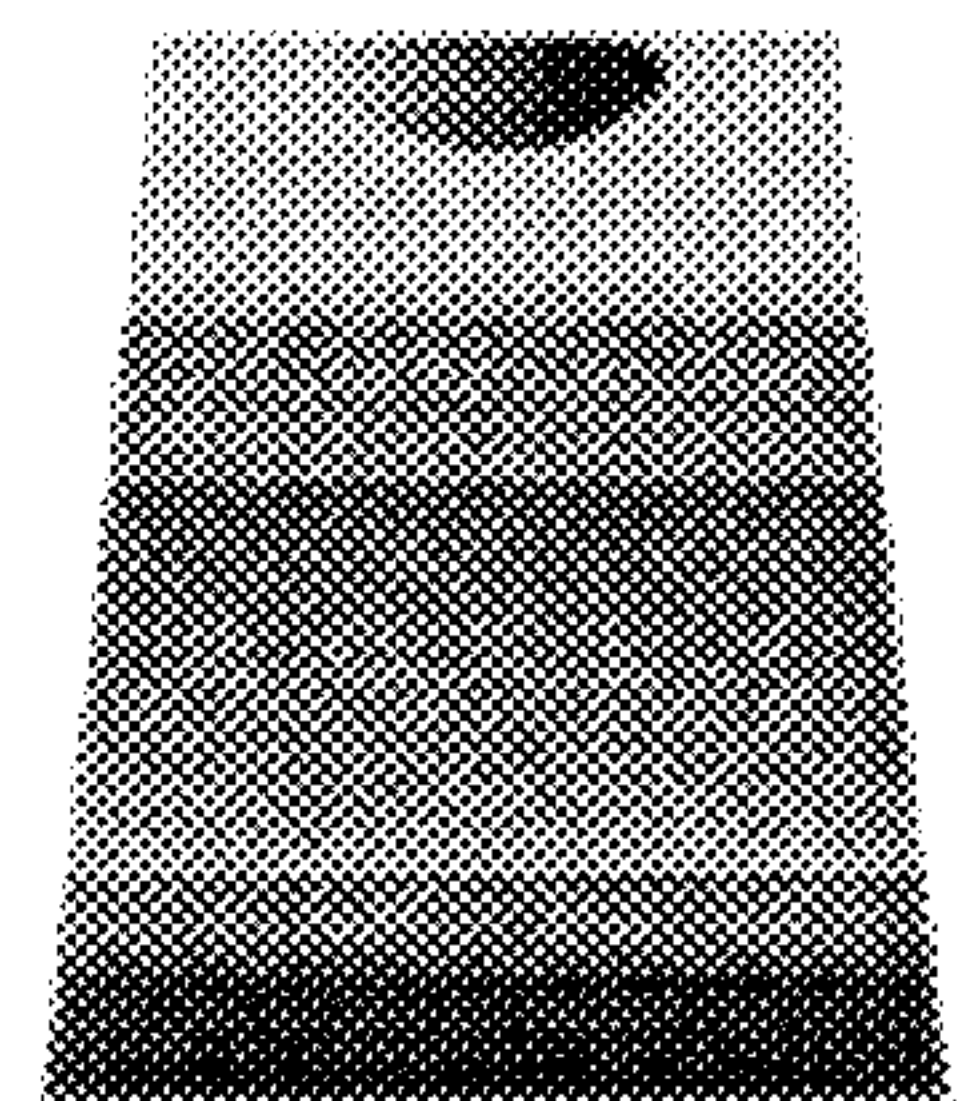

Fig. 103

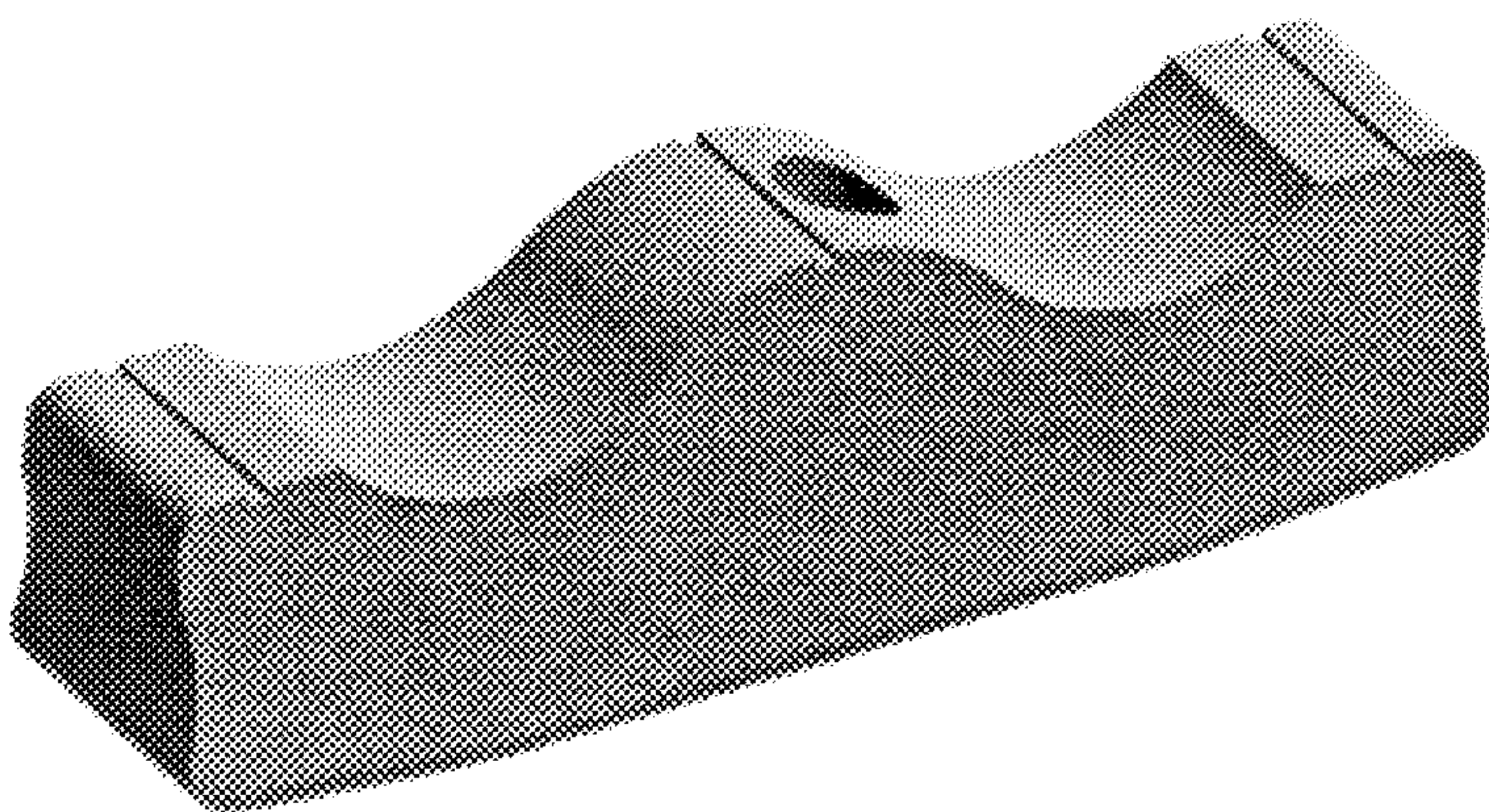

Fig. 104

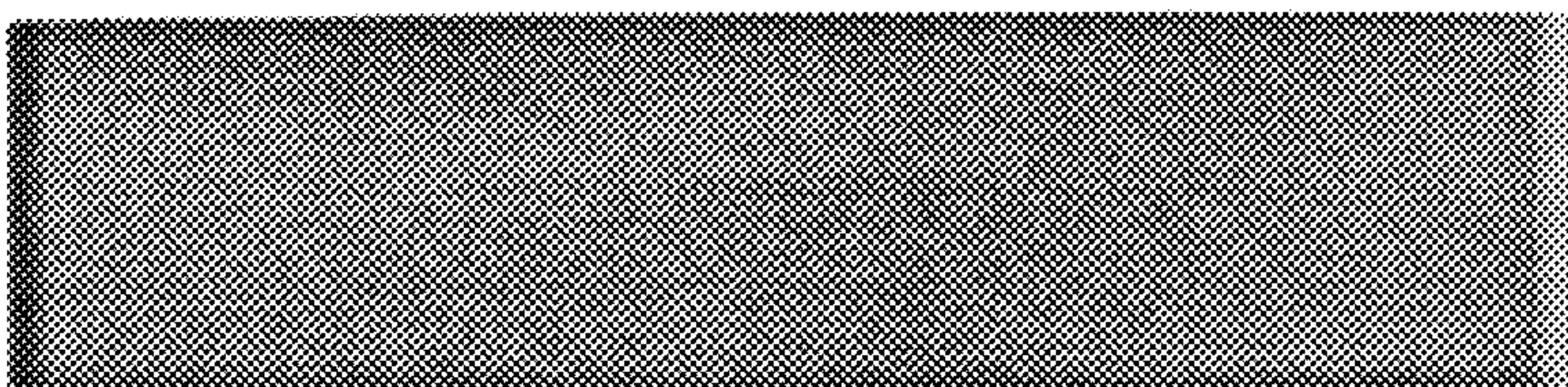

Fig. 105

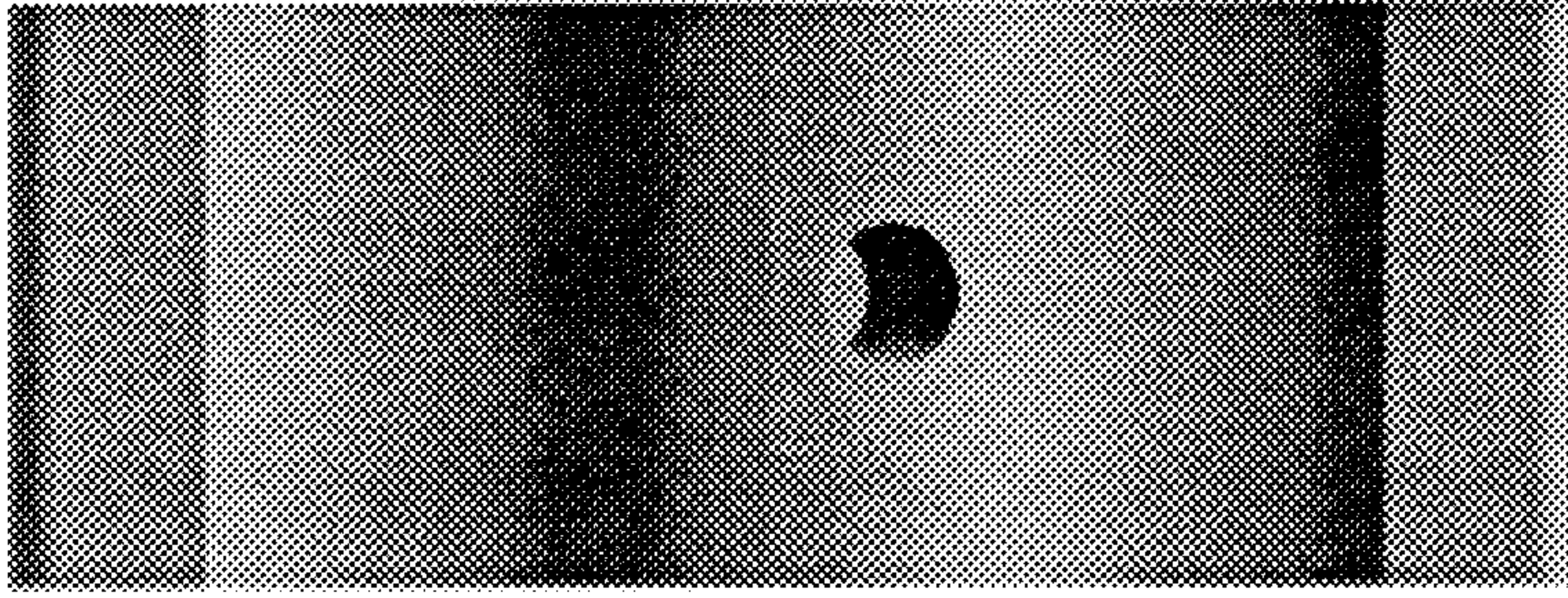

Fig. 106



Fig. 107

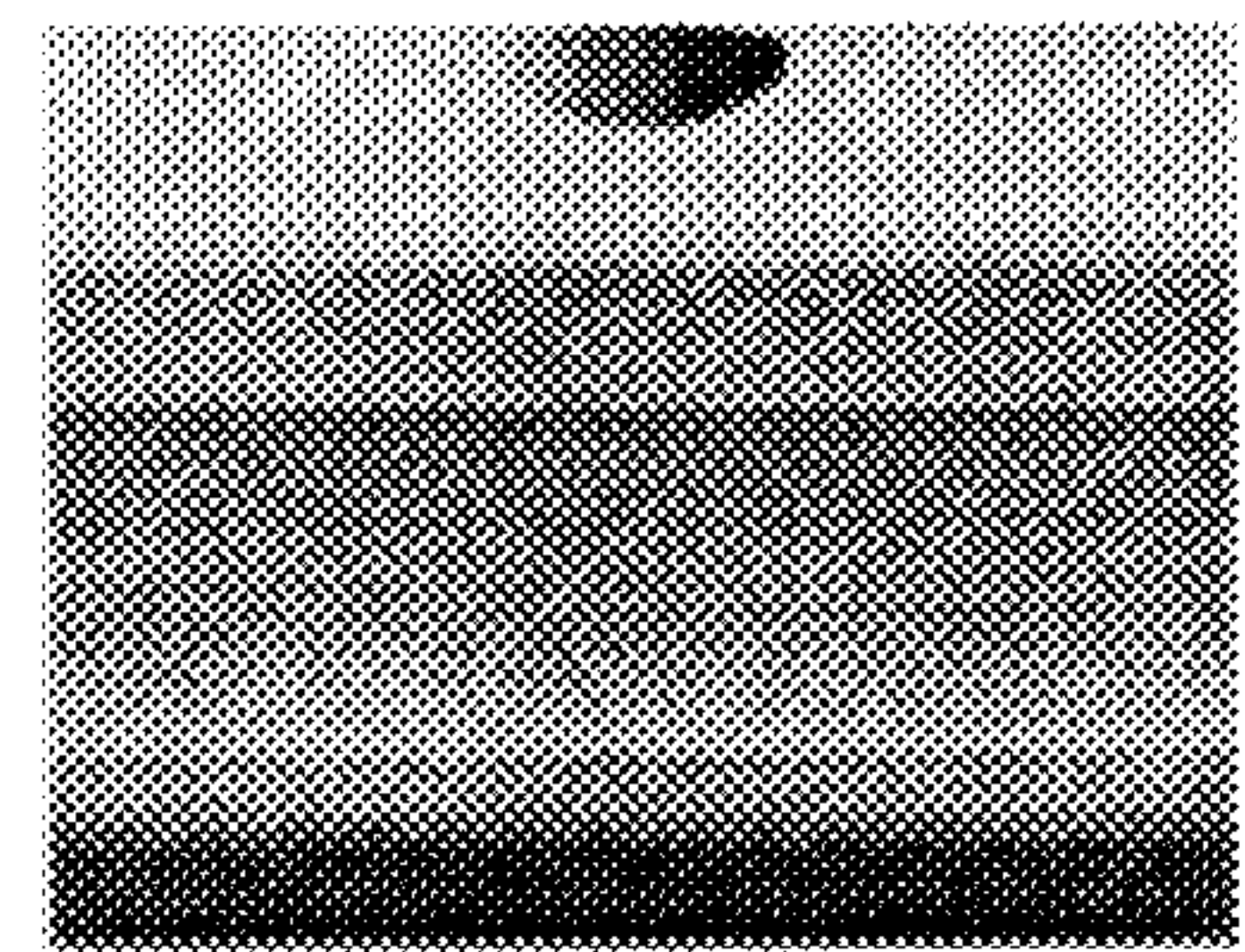

Fig. 108

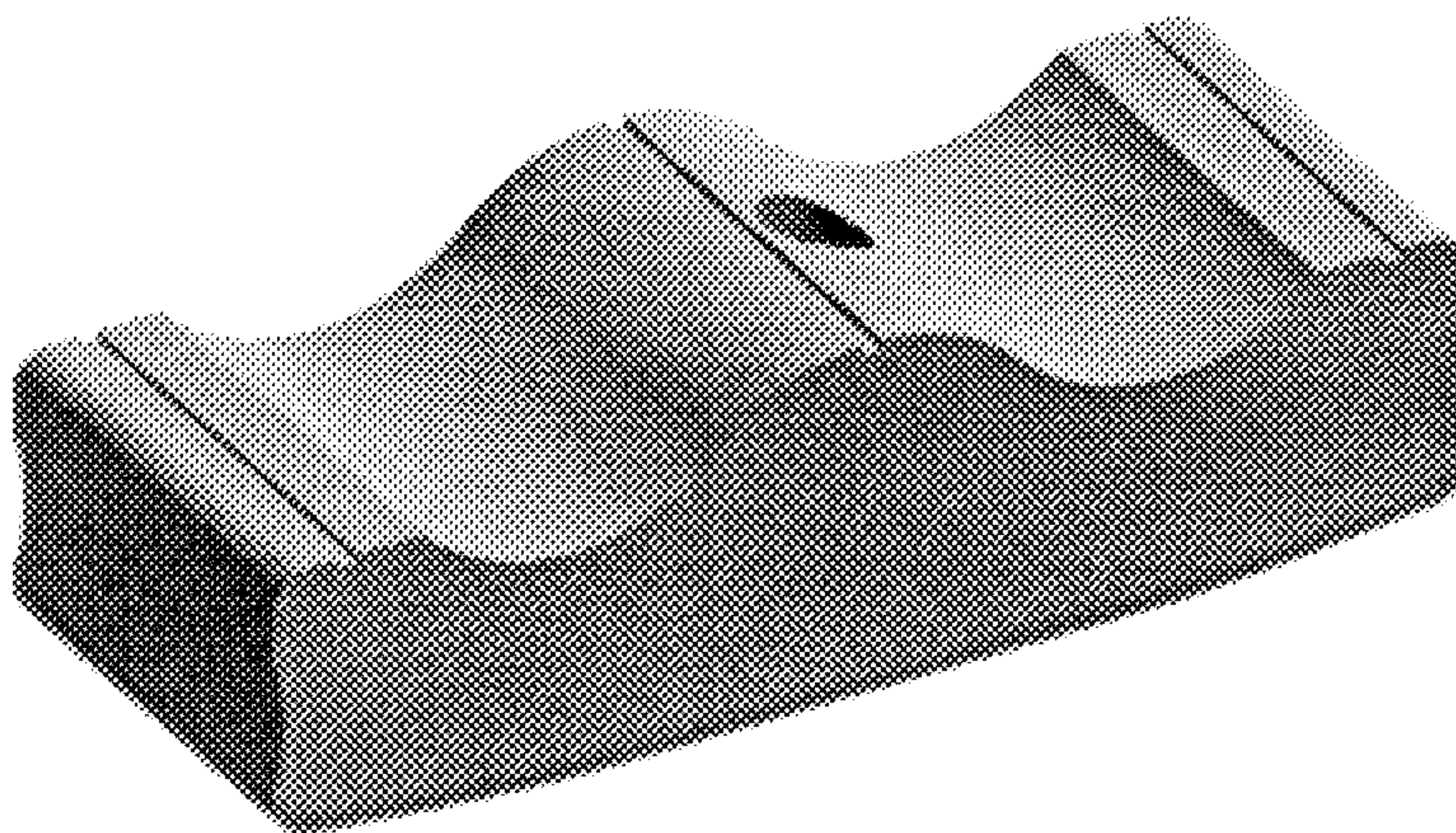

Fig. 109

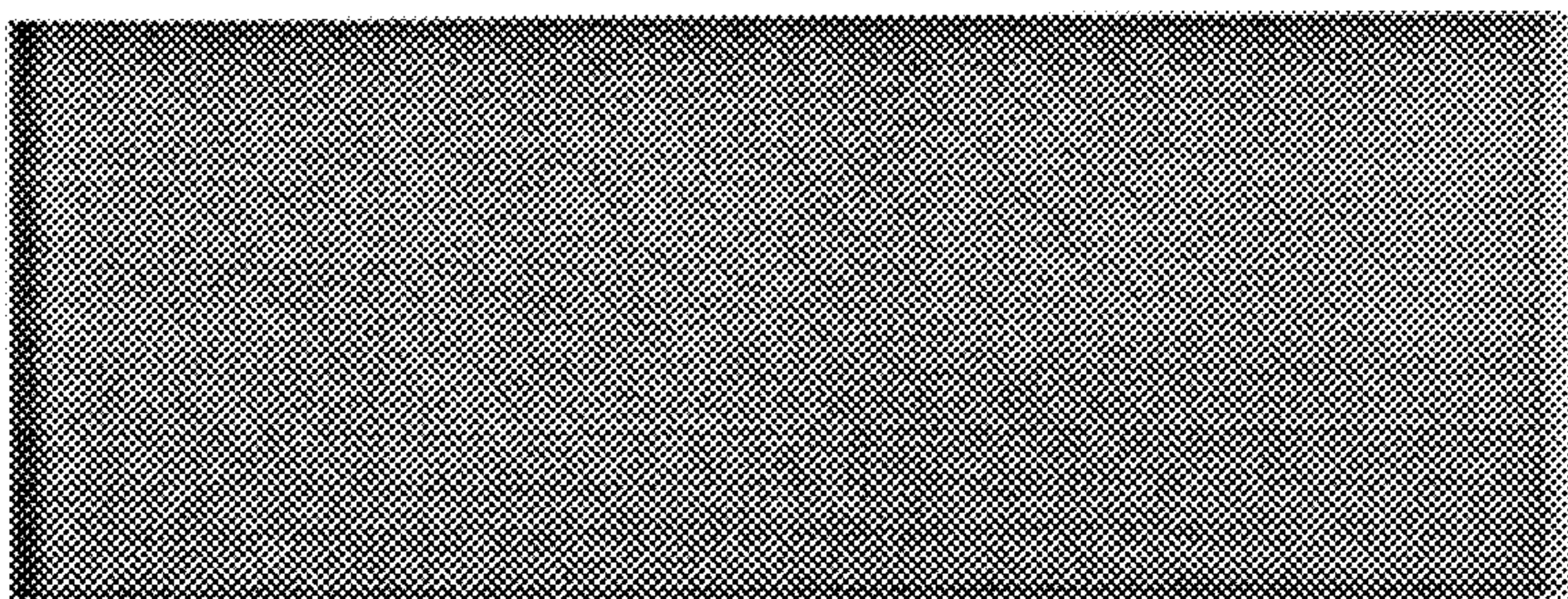

Fig. 110

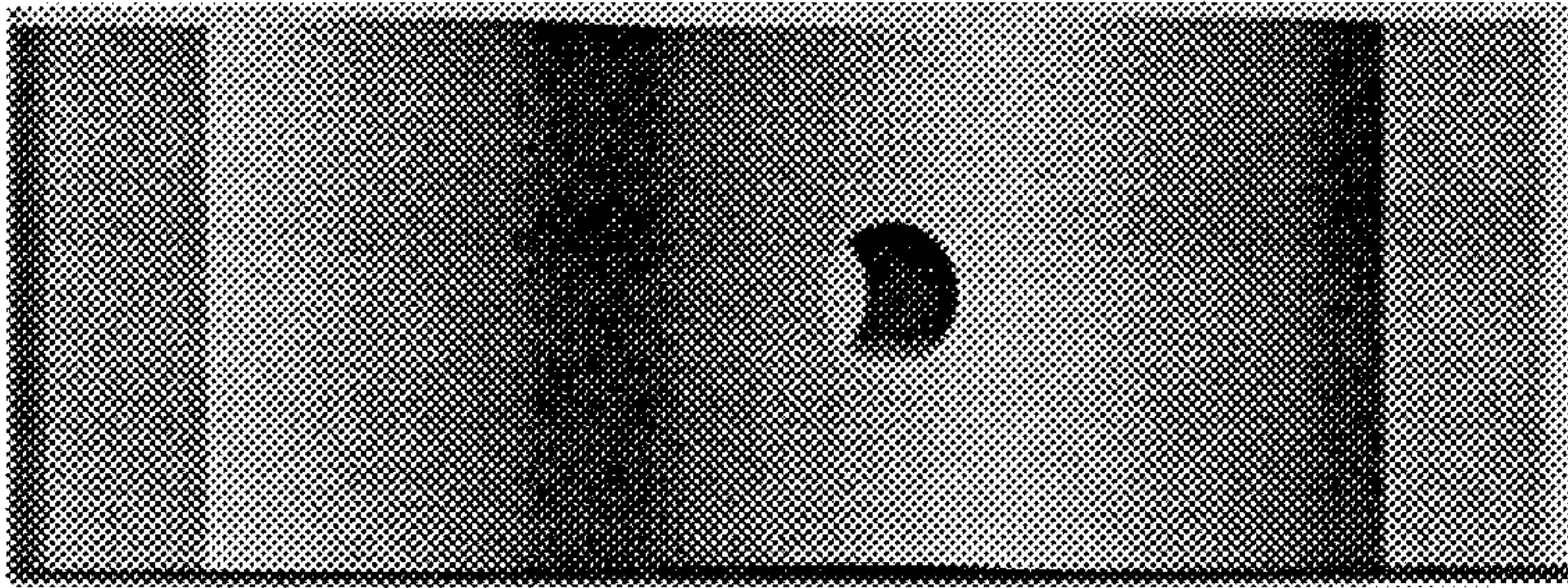

Fig. 111



Fig. 112

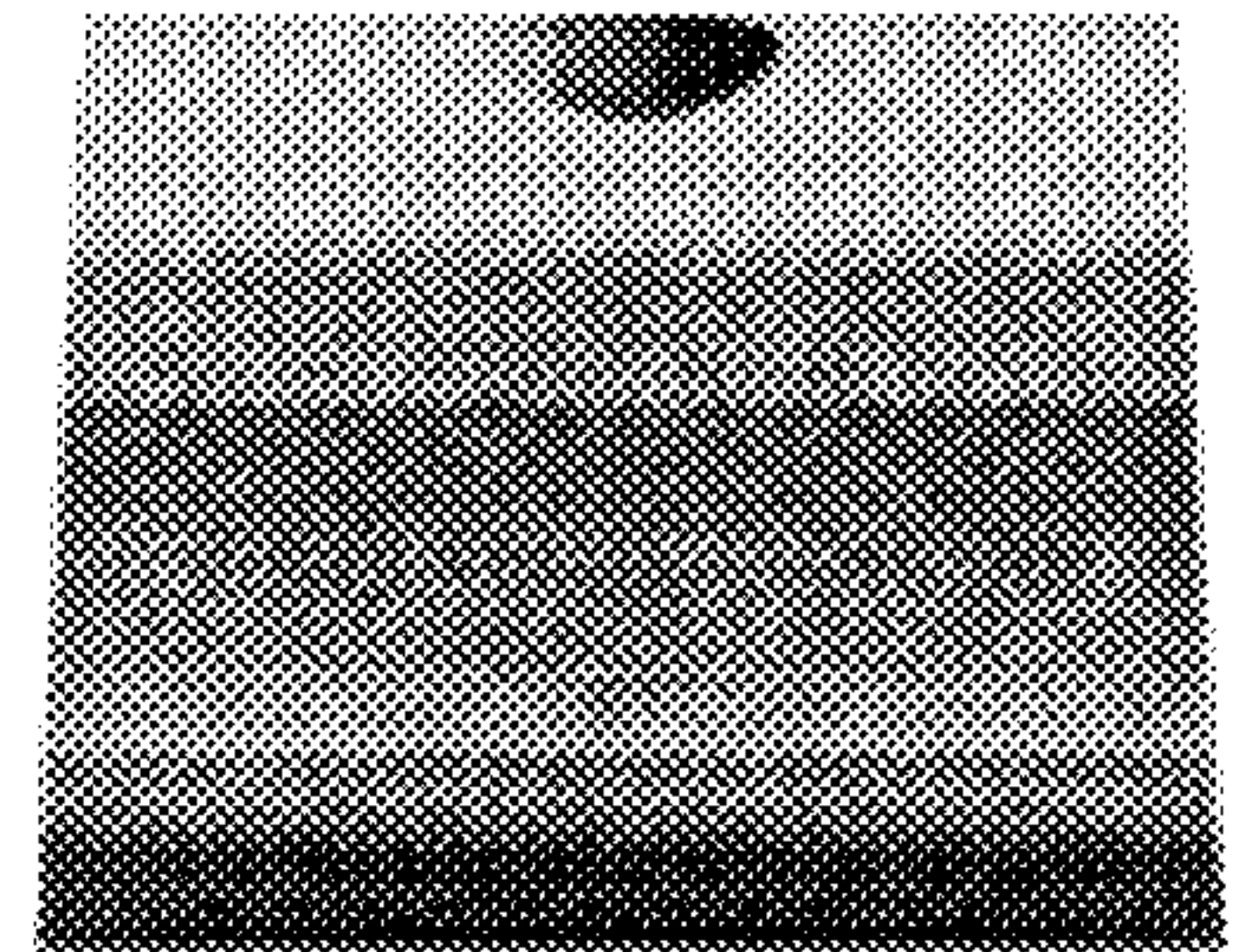

Fig. 113

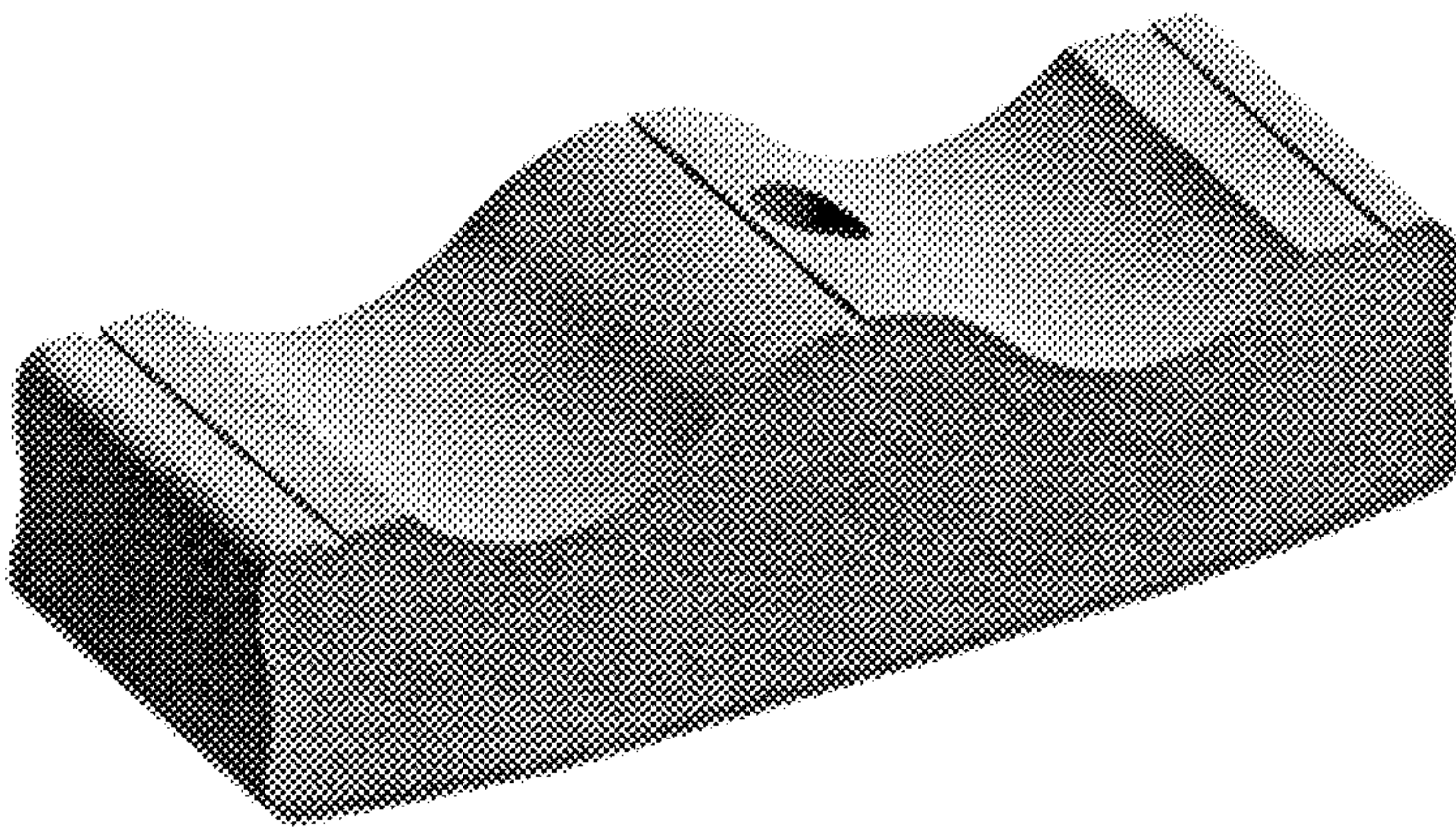

Fig. 114

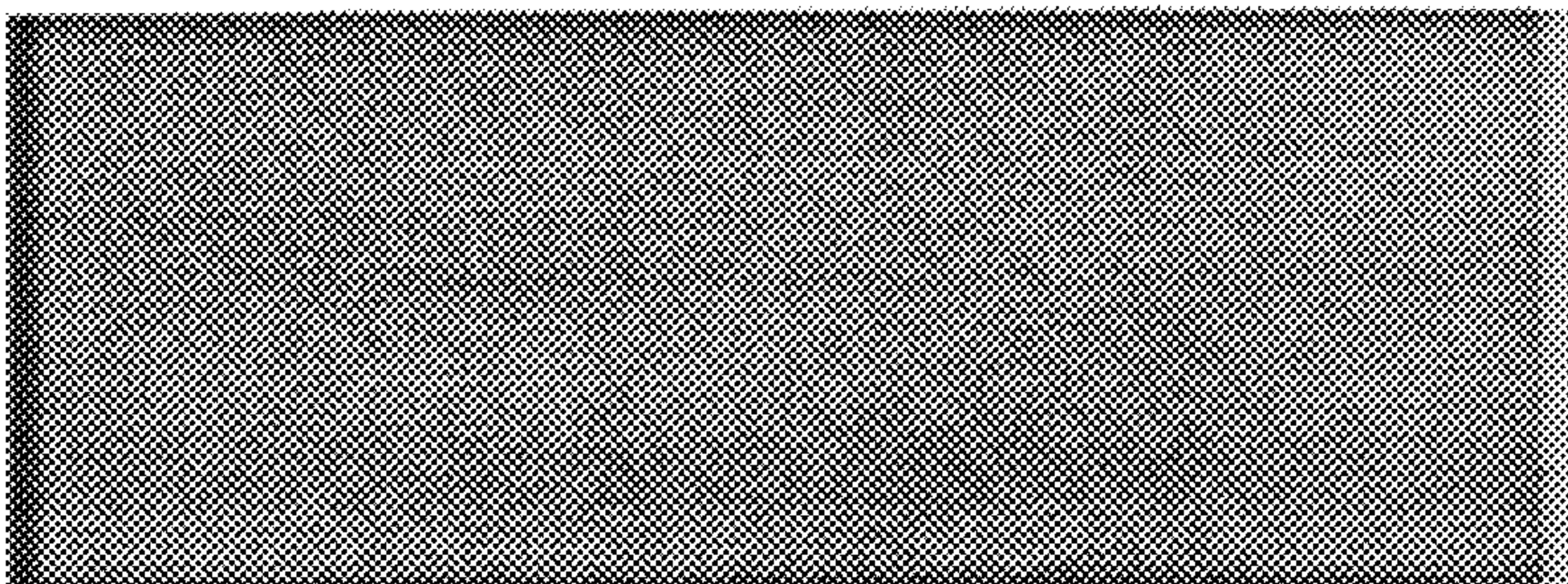

Fig. 115

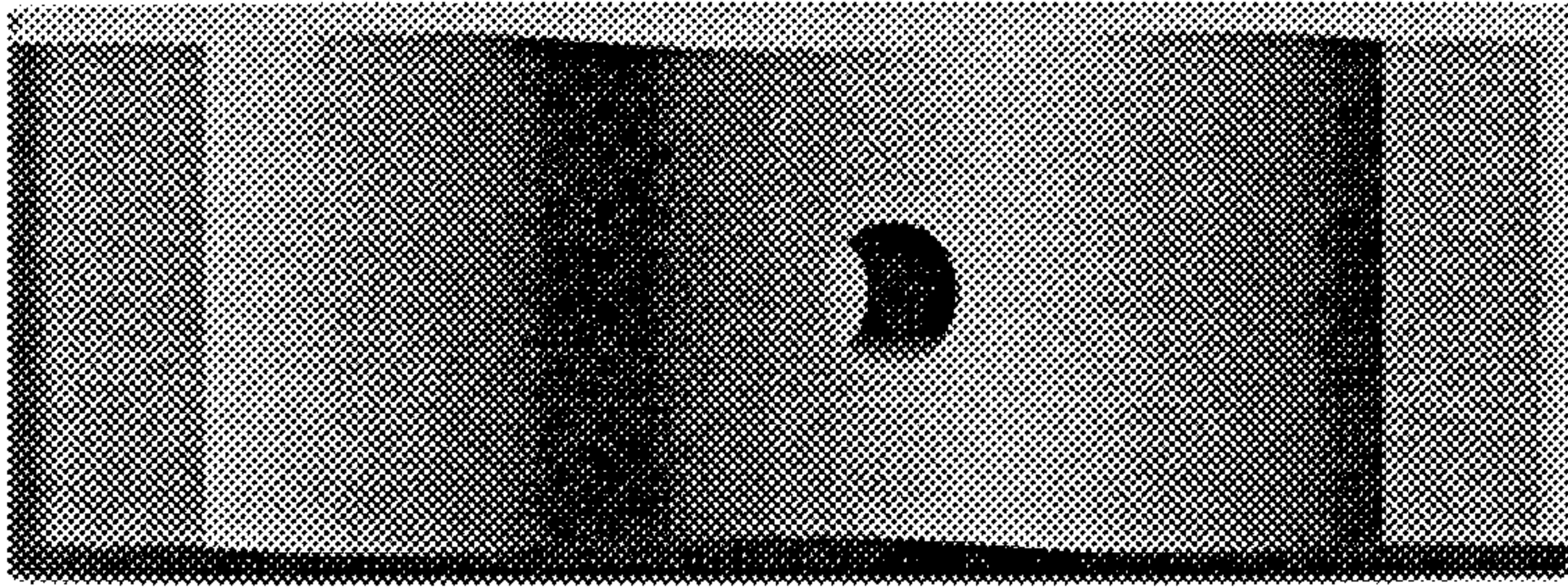

Fig. 116

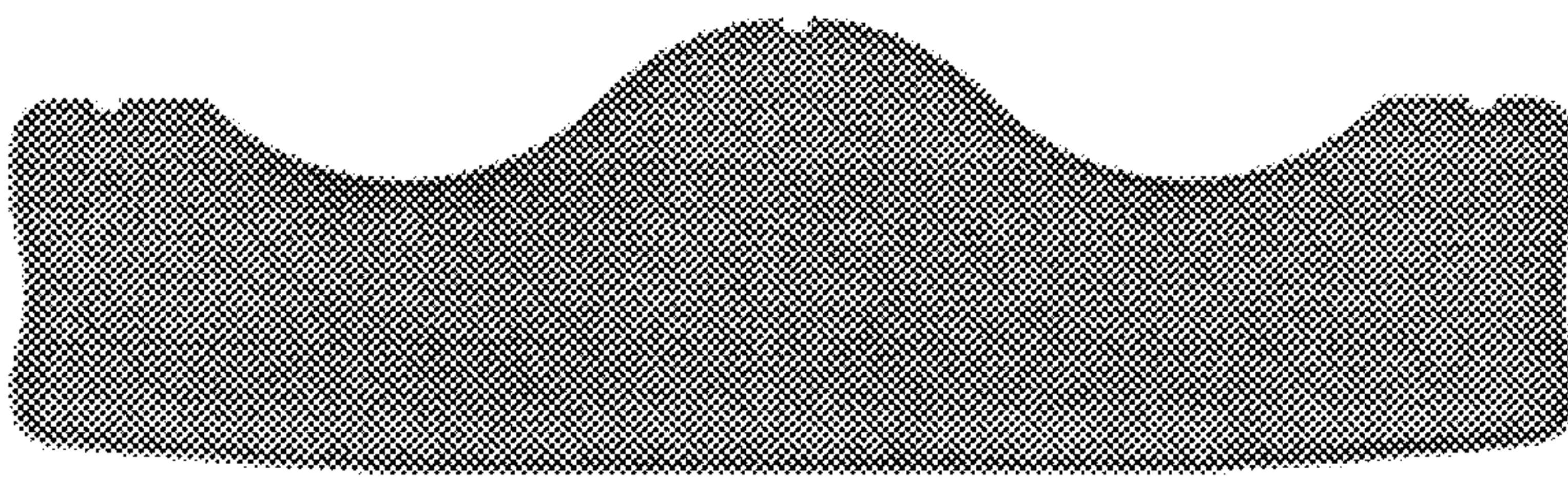

Fig. 117

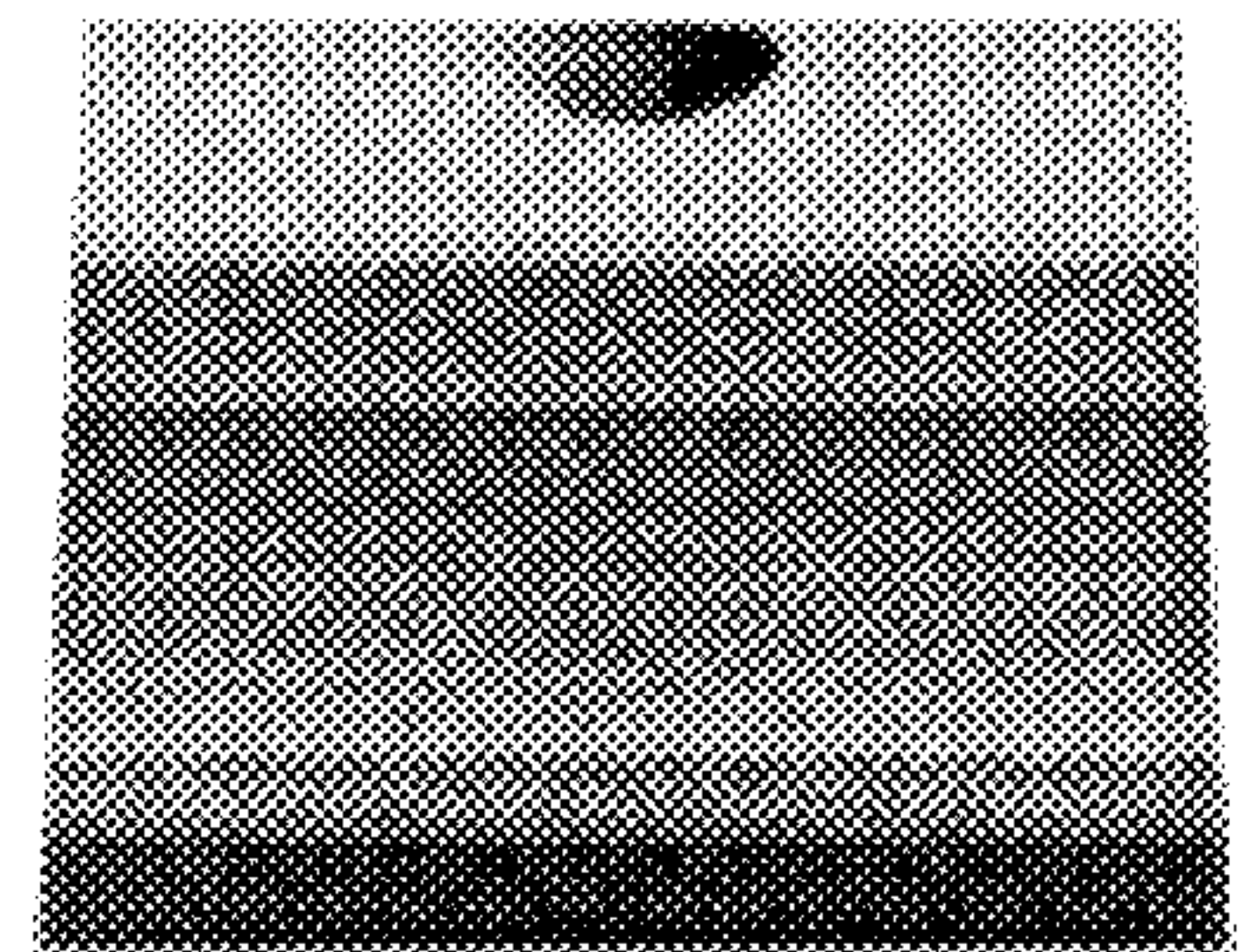

Fig. 118

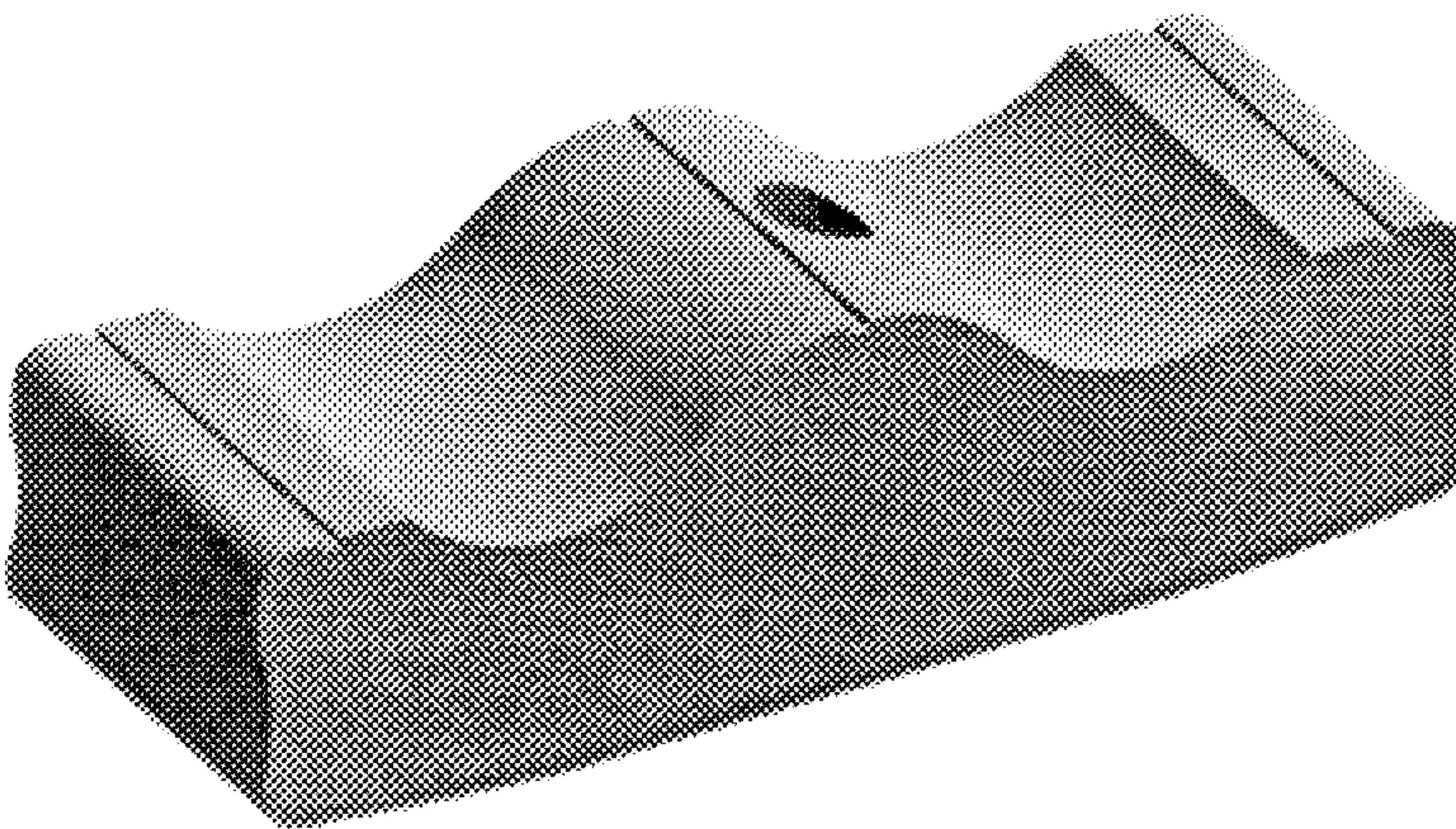

Fig. 119

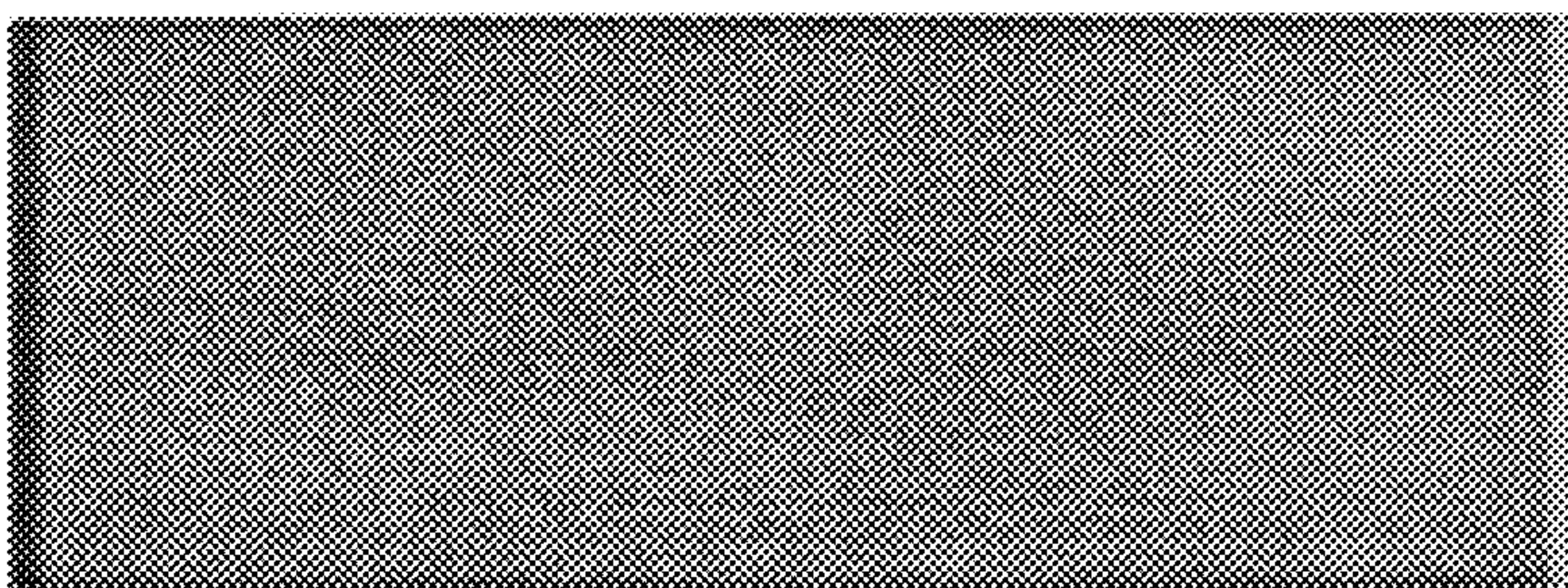

Fig. 120

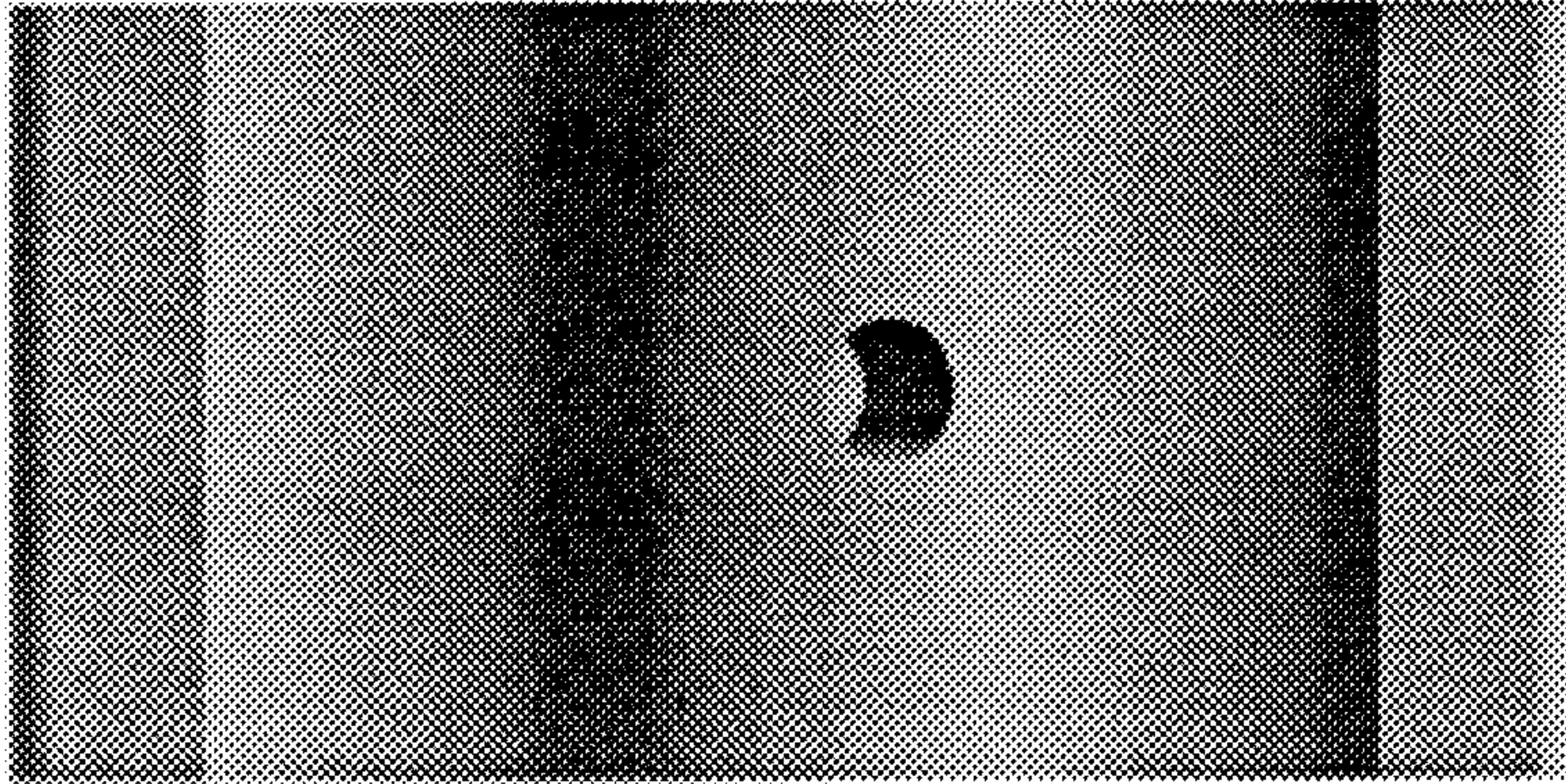

Fig. 121

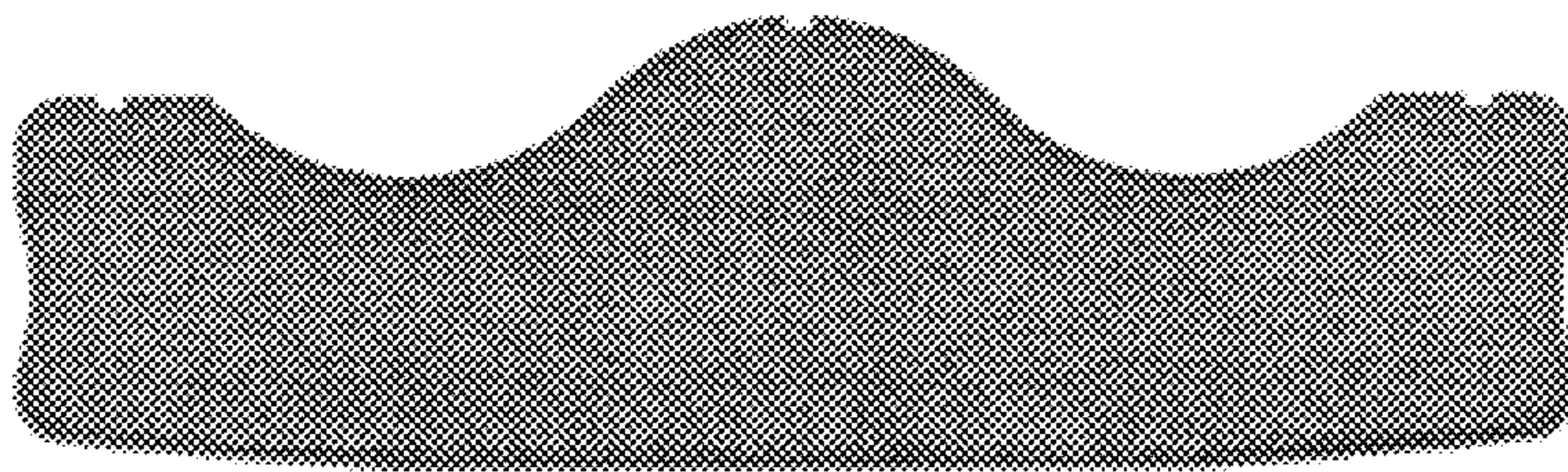

Fig. 122

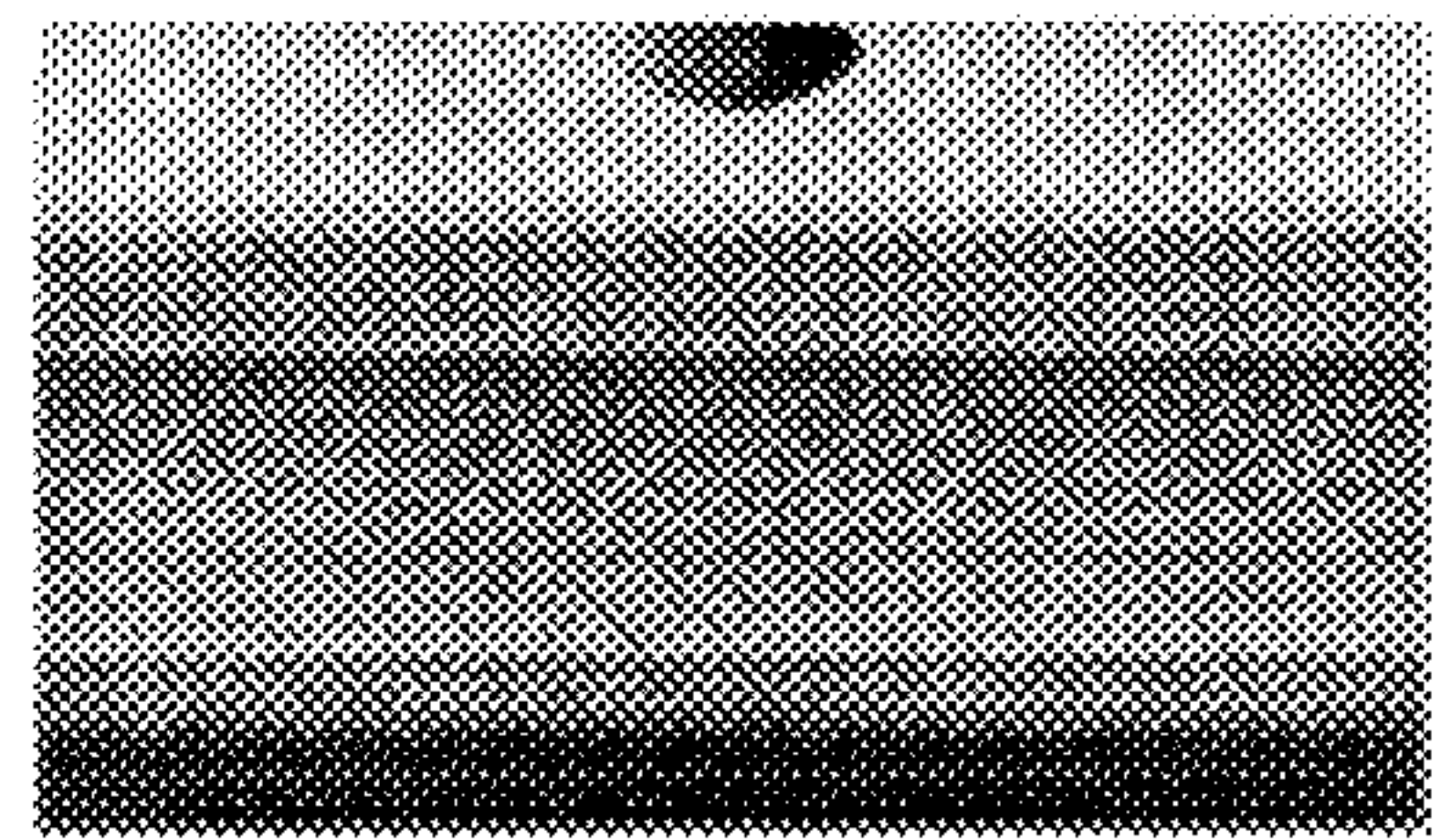

Fig. 123

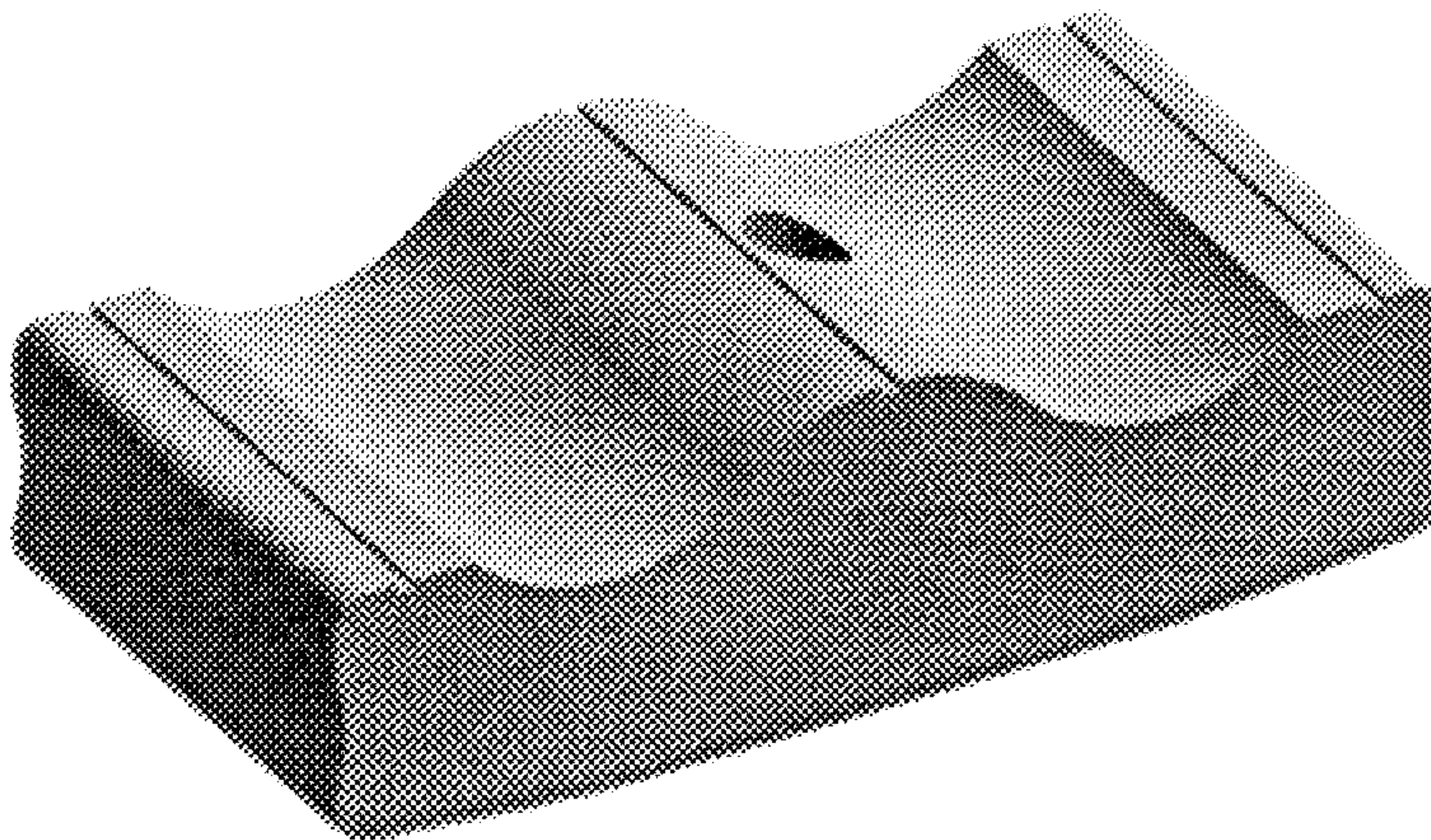

Fig. 124

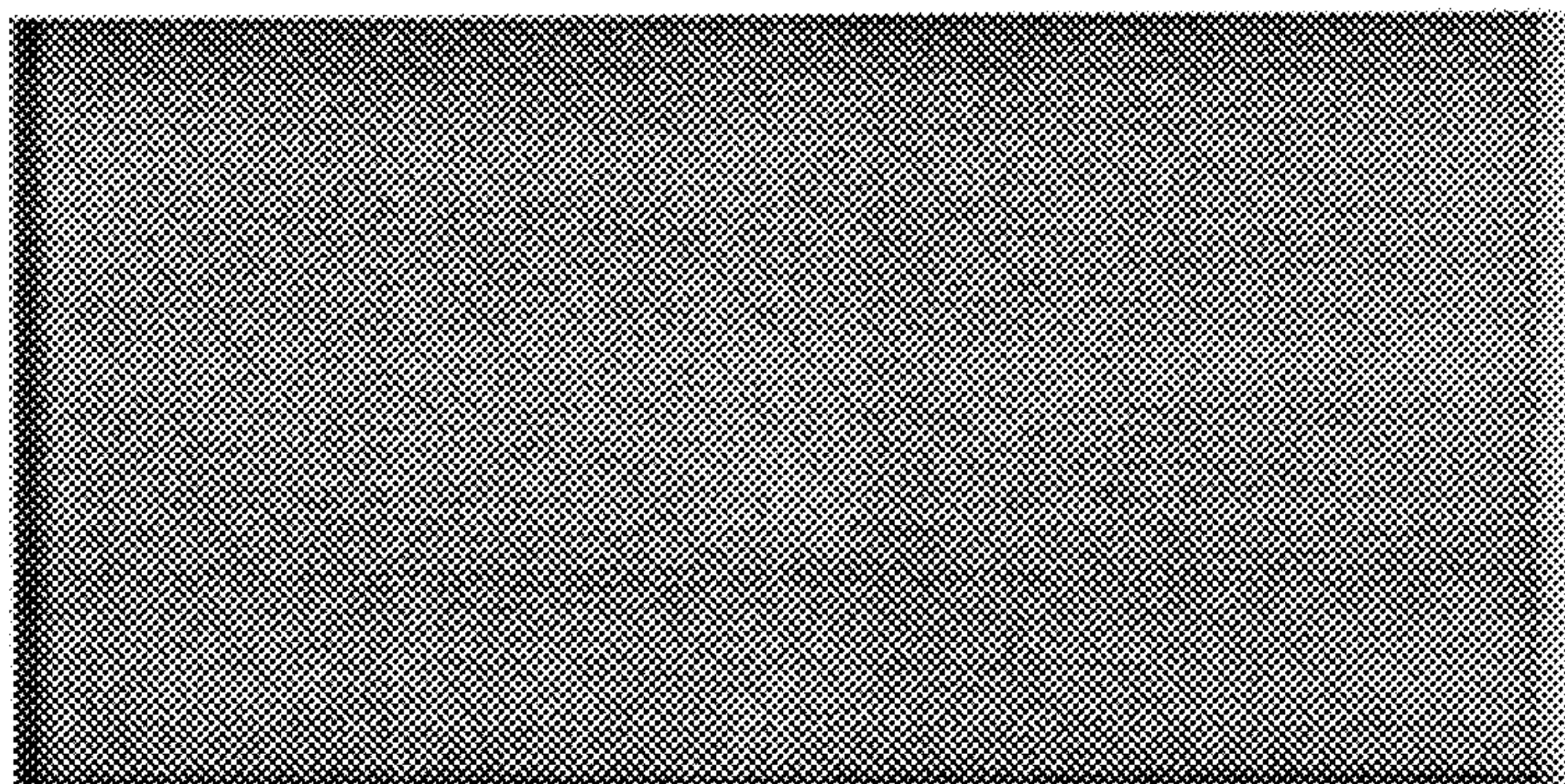

Fig. 125

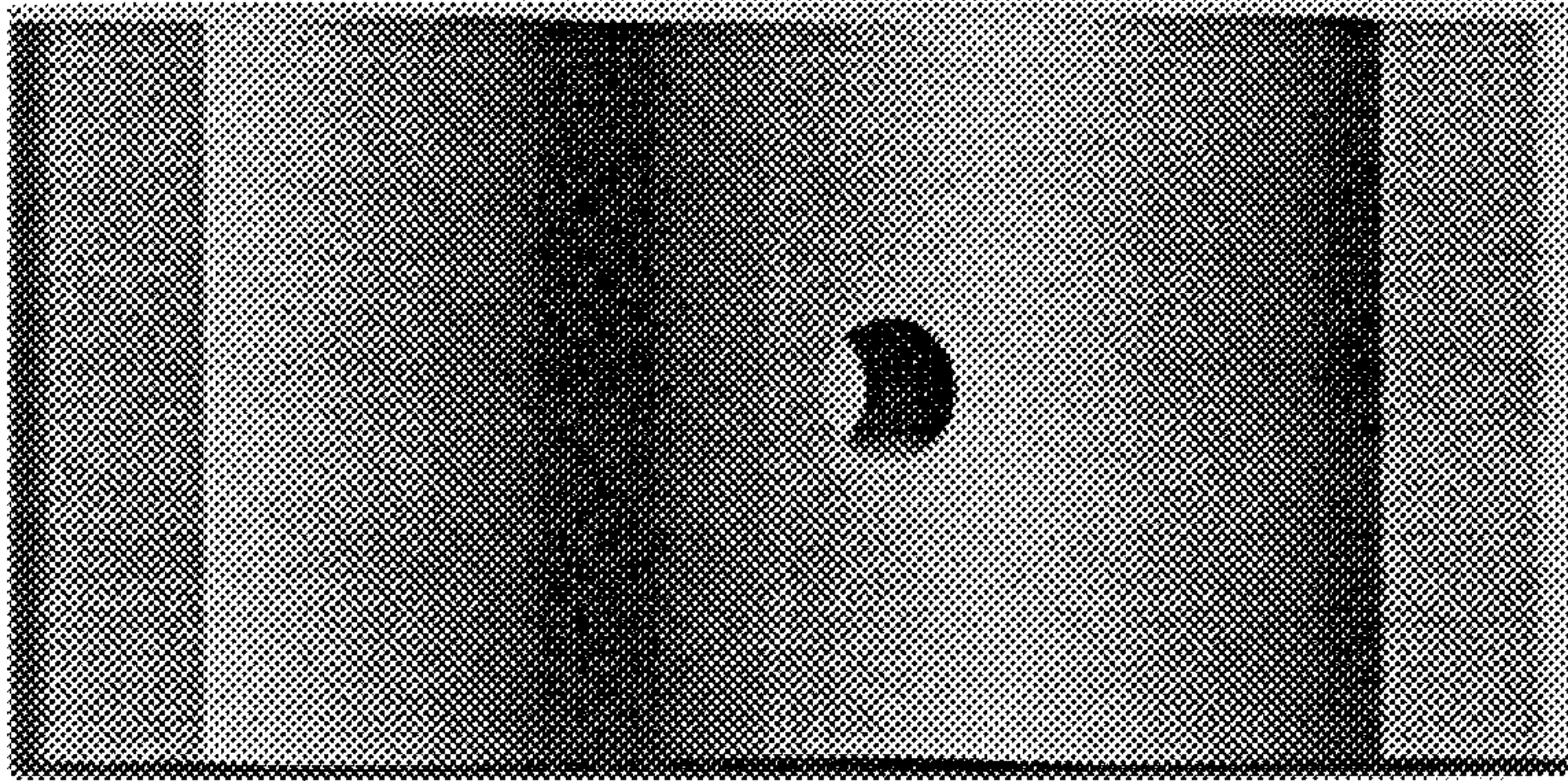

Fig. 126

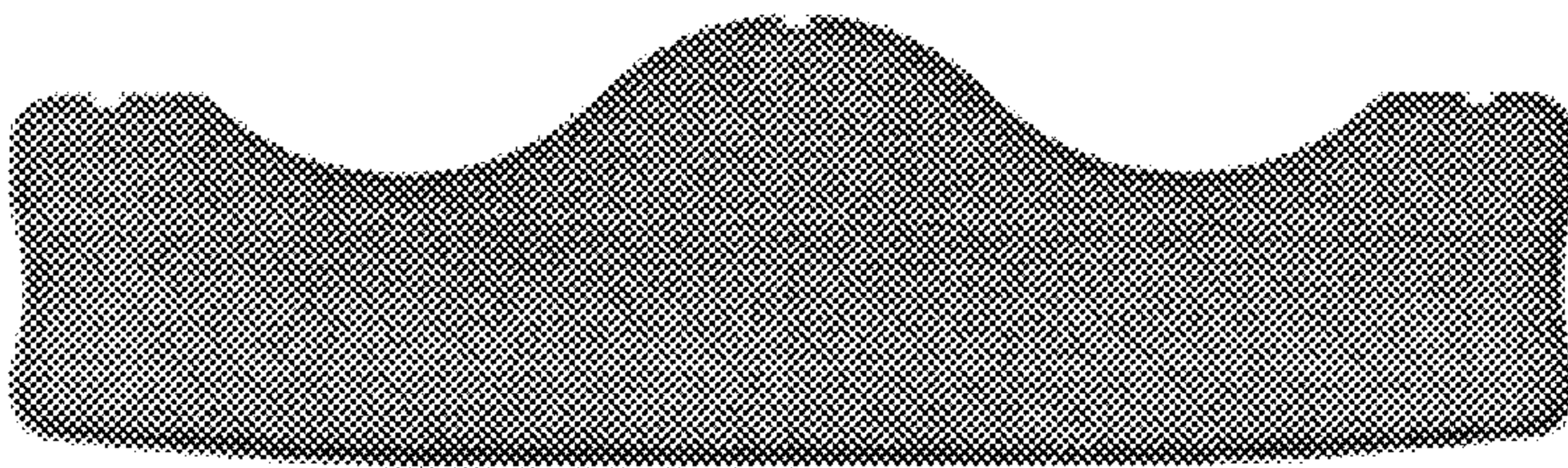

Fig. 127

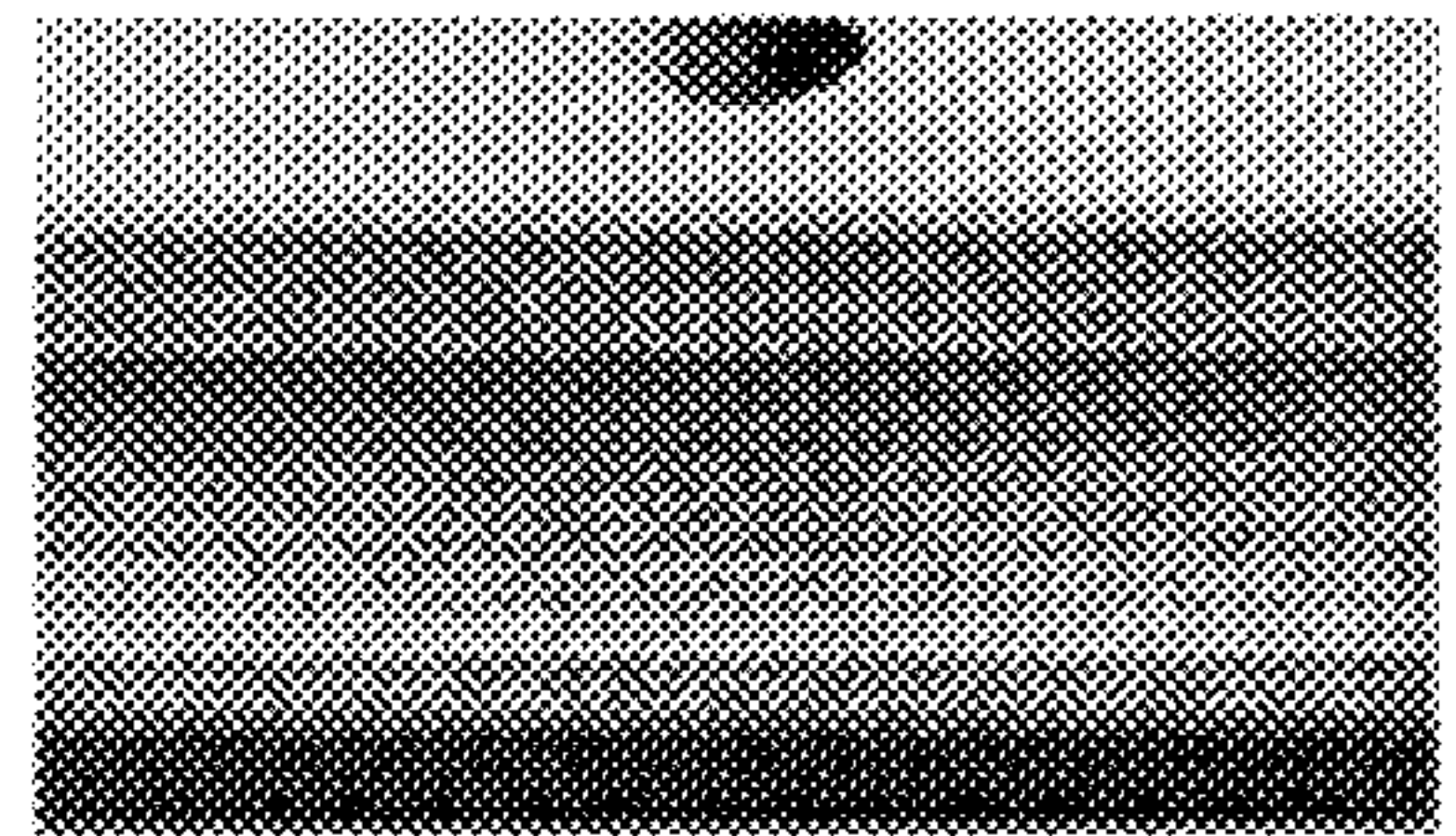

Fig. 128

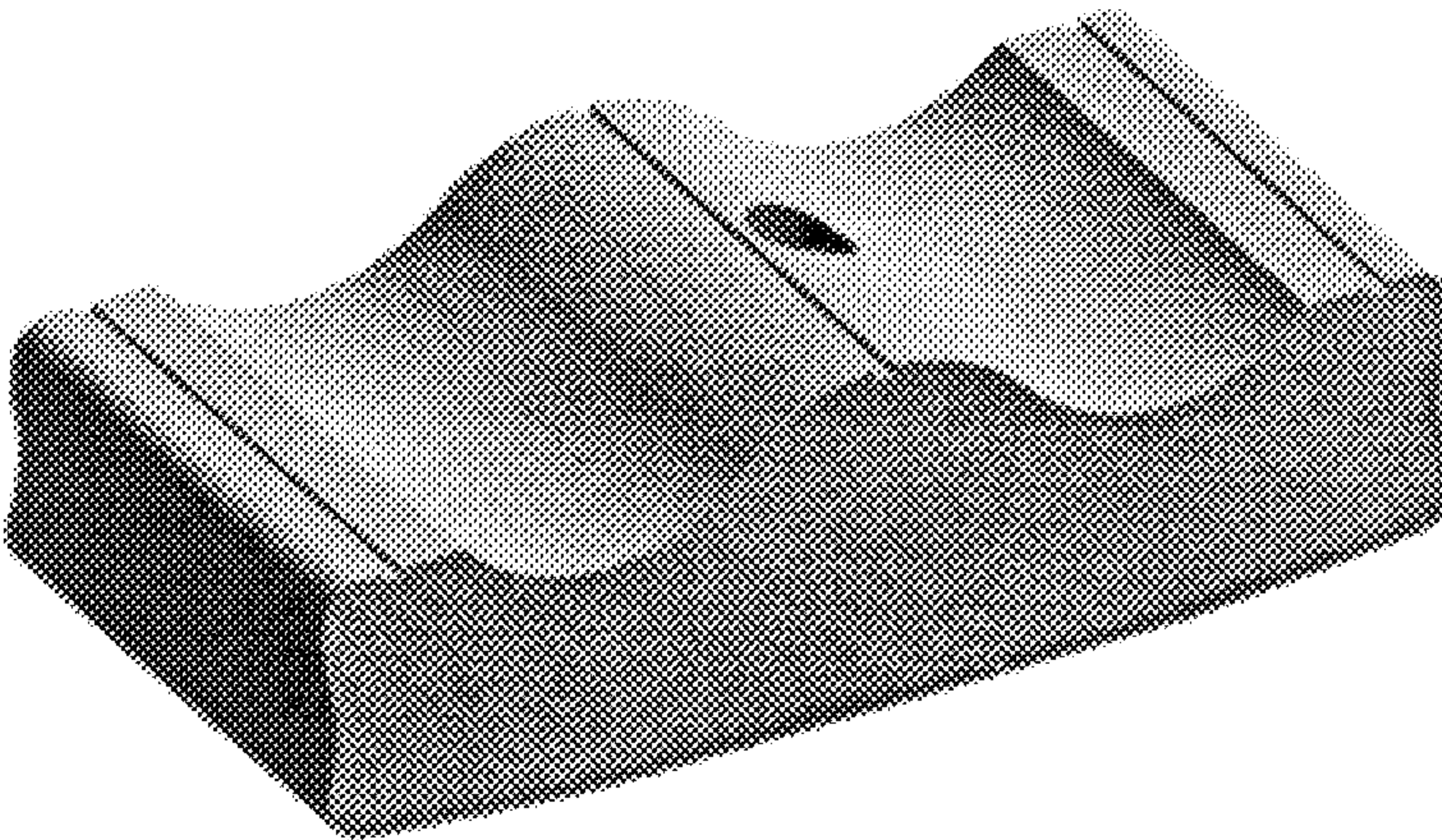

Fig. 129

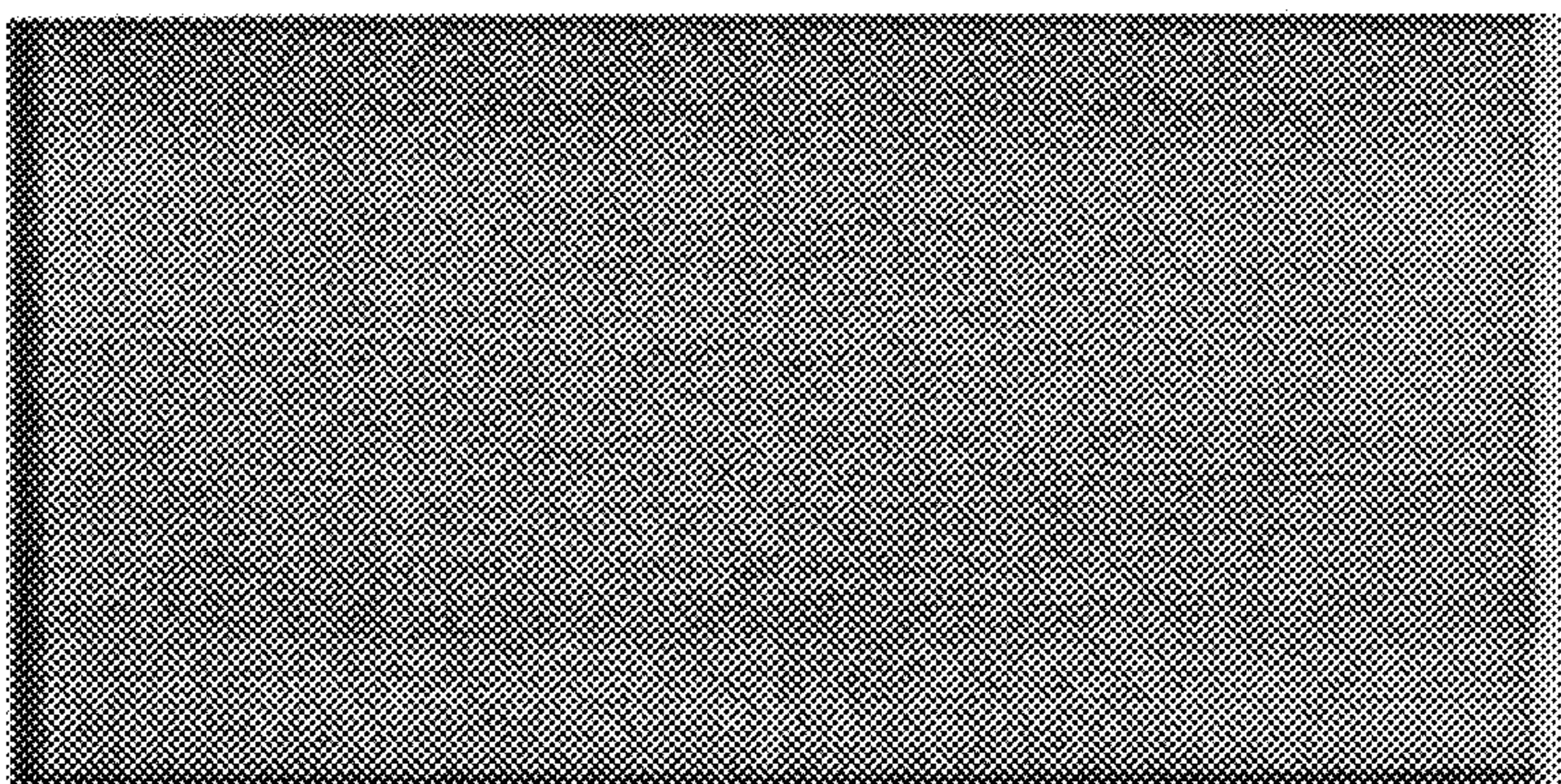

Fig. 130

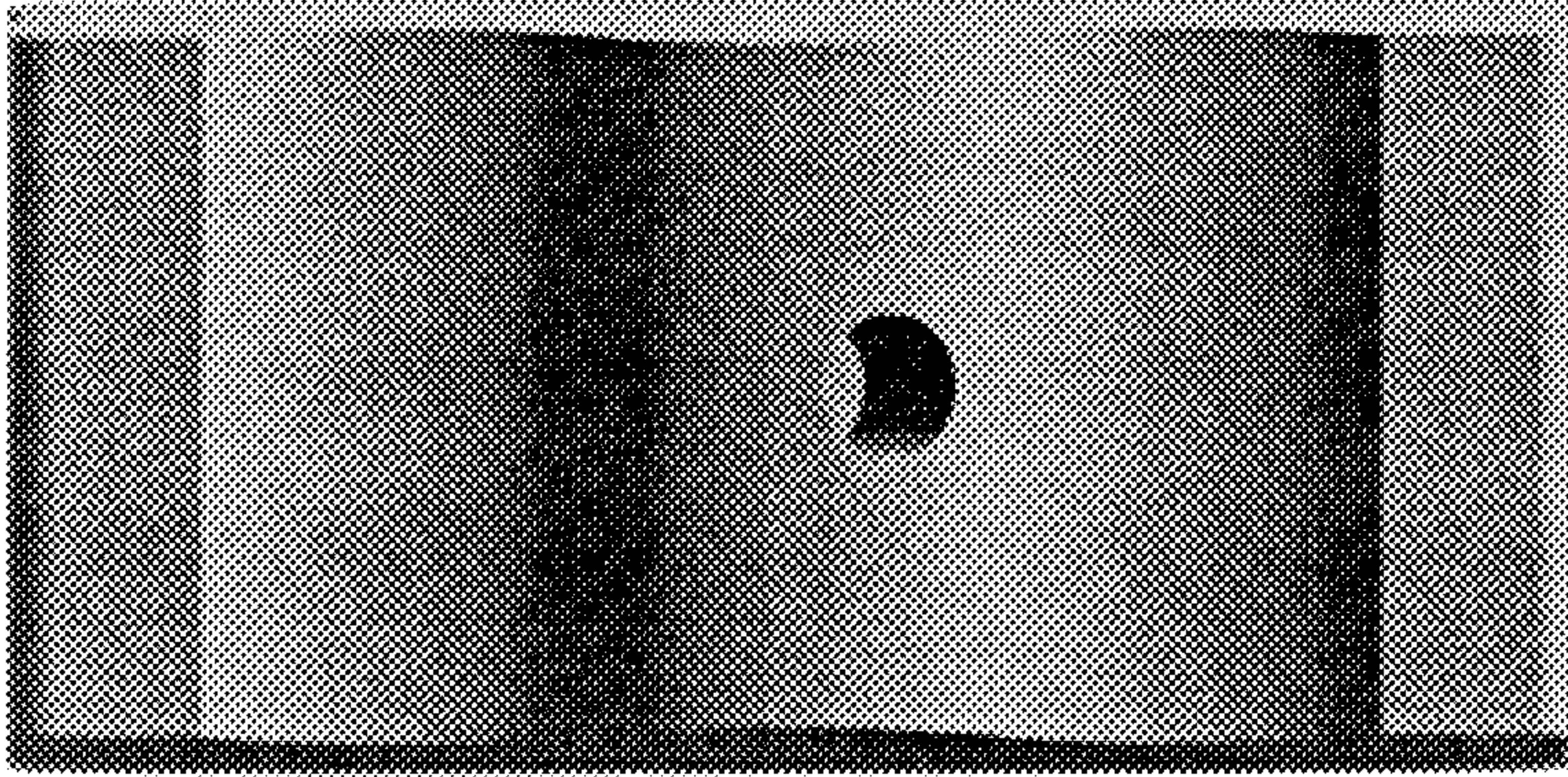

Fig. 131

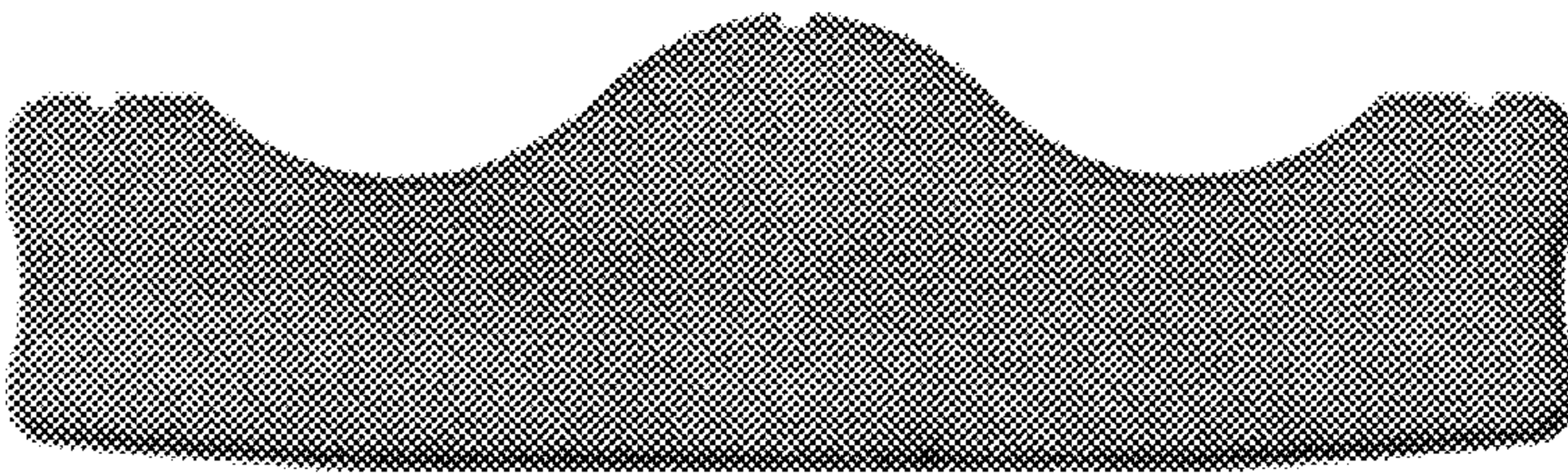

Fig. 132

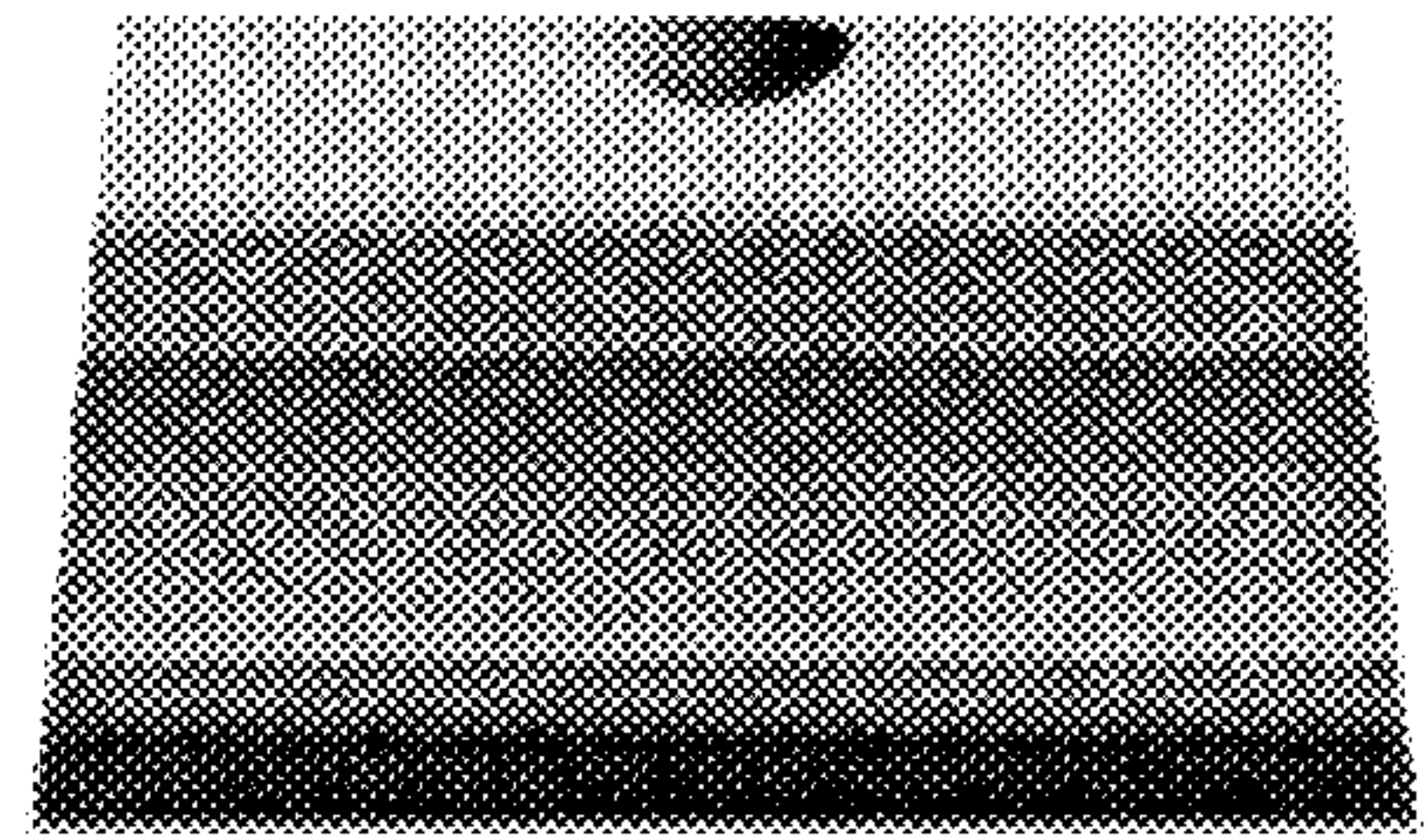

Fig. 133

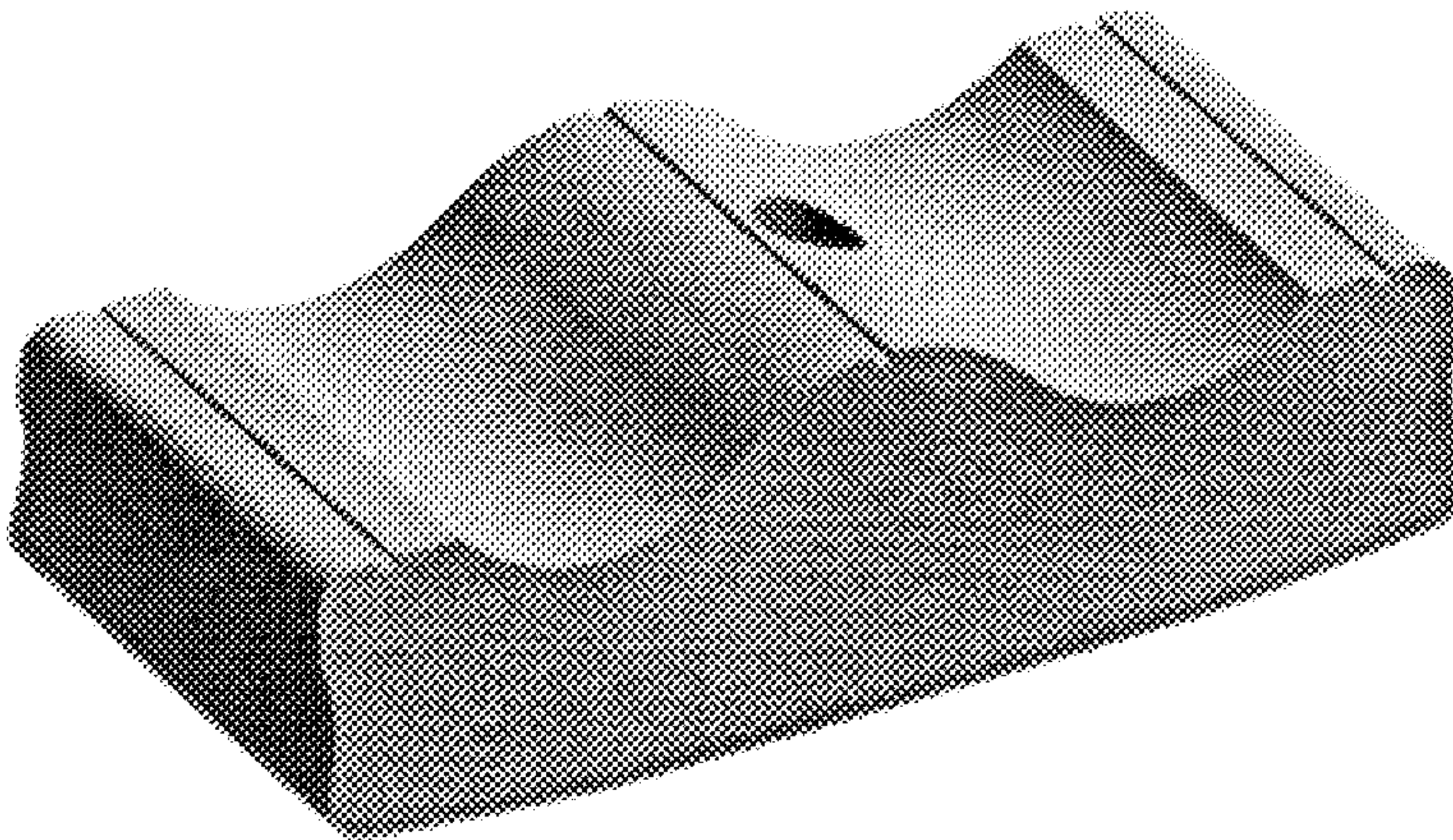

Fig. 134

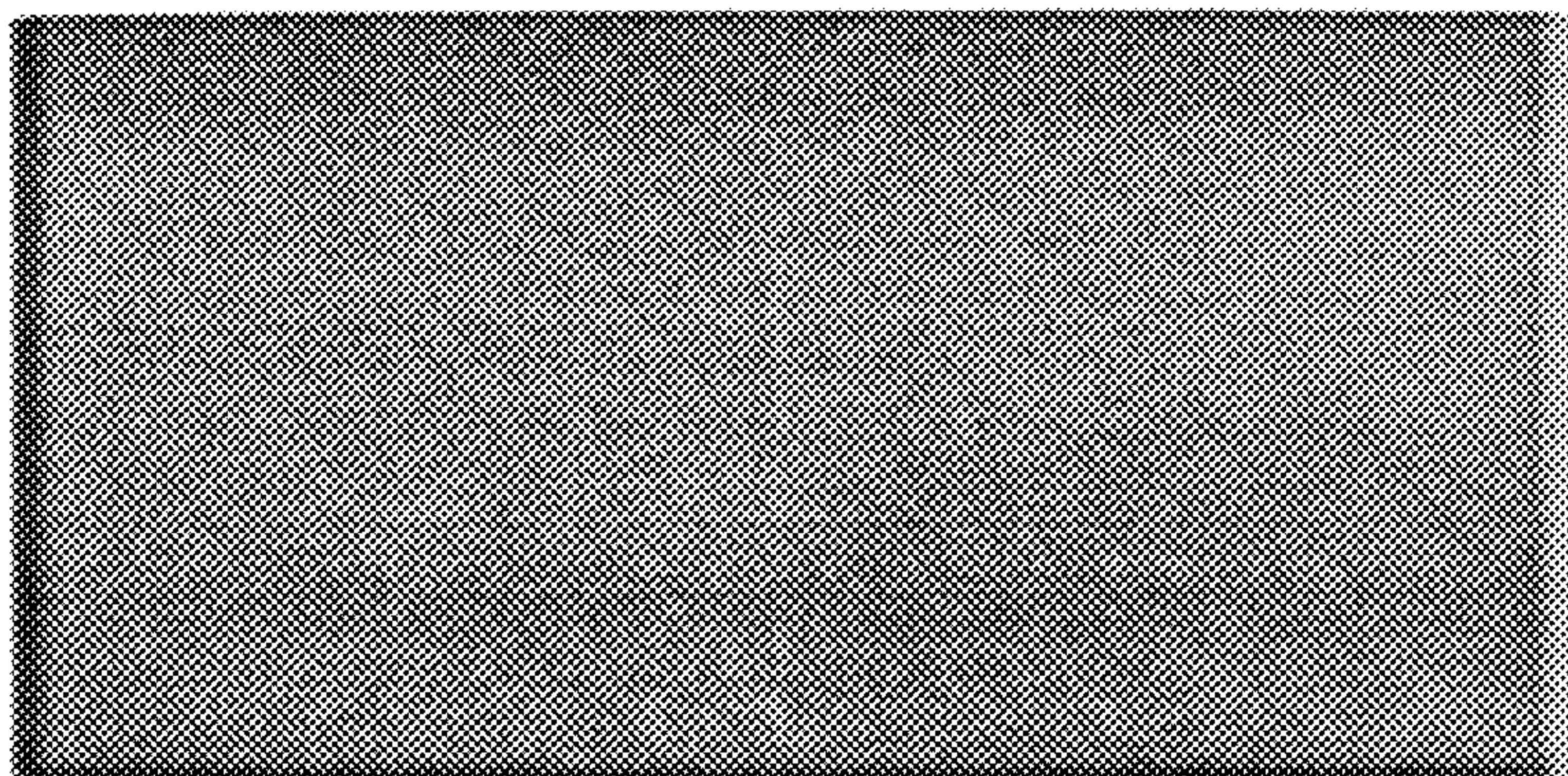

Fig. 135