



US00D406258S

United States Patent [19]
Segers

[11] **Patent Number: Des. 406,258**

[45] **Date of Patent: **Mar. 2, 1999**

[54] **BATTERY PACK FOR A MOBILE RADIOTELEPHONE DEVICE**

[75] Inventor: **Reinhard Segers**, Munich, Germany

[73] Assignee: **Siemens Aktiengesellschaft**, Munich, Germany

[**] Term: **14 Years**

[21] Appl. No.: **81,414**

[22] Filed: **Dec. 31, 1997**

[30] **Foreign Application Priority Data**

Jul. 3, 1997 [DE] Germany M 97 06 204.9

[51] **LOC (6) Cl.** **13-02**

[52] **U.S. Cl.** **D13/103**

[58] **Field of Search** D13/103; D14/138; 429/96-100, 163, 176; 455/127, 343

[56] **References Cited**

U.S. PATENT DOCUMENTS

- D. 283,812 5/1986 Liataud et al. D13/103
- D. 360,184 7/1995 Richards et al. D13/103
- D. 382,536 8/1997 Amero, Jr. D13/103
- D. 386,147 11/1997 Siddoway et al. D13/103
- D. 391,622 3/1998 Huynh et al. D13/103
- 5,436,088 7/1995 Castaneda et al. 429/96

Primary Examiner—Joel Sincavage

Attorney, Agent, or Firm—Hill & Simpson

[57] **CLAIM**

The ornamental design for a battery pack for a mobile radiotelephone device, as shown and described.

DESCRIPTION

FIG. 1 is a perspective view of a battery pack for a mobile radiotelephone device in accordance with the present invention;

FIG. 2 is a front elevational view of the battery pack of FIG. 1;

FIG. 3 is a back elevational view of the battery pack of FIG. 1;

FIG. 4 is a side view of the left side of the battery pack of FIG. 2;

FIG. 5 is a side view of the right side of the battery pack of FIG. 2;

FIG. 6 is an end view of the bottom of the battery pack of FIG. 2;

FIG. 7 is an end view of the top of the battery pack of FIG. 2; and,

FIG. 8 is a perspective view showing the insertion of the battery pack in a mobile radiotelephone device.

The broken line showing the mobile telephone device in FIG. 8 is included for the purposes of illustrating the environmental elements only and forms no part of the claimed design.

1 Claim, 3 Drawing Sheets

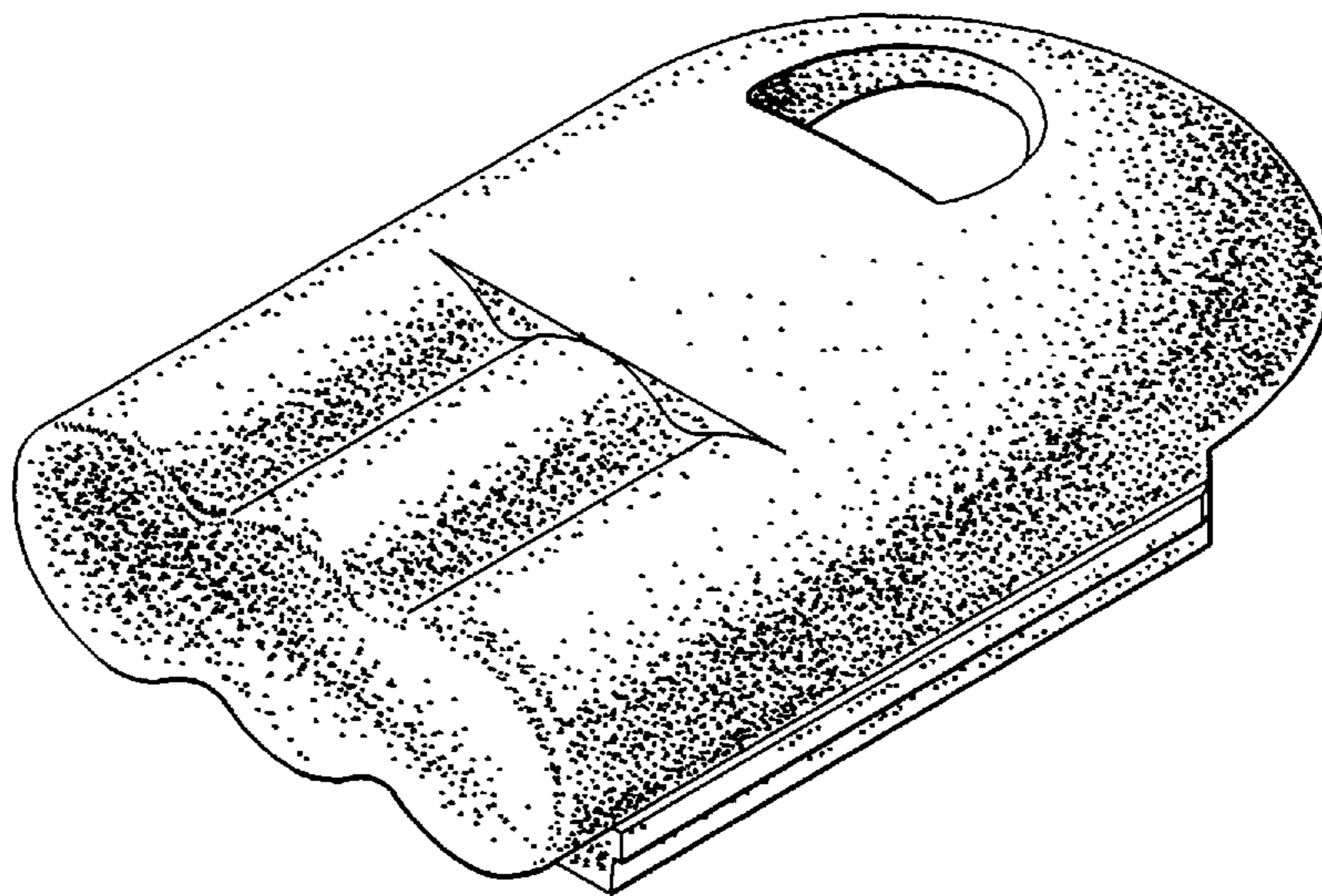

FIG. 1

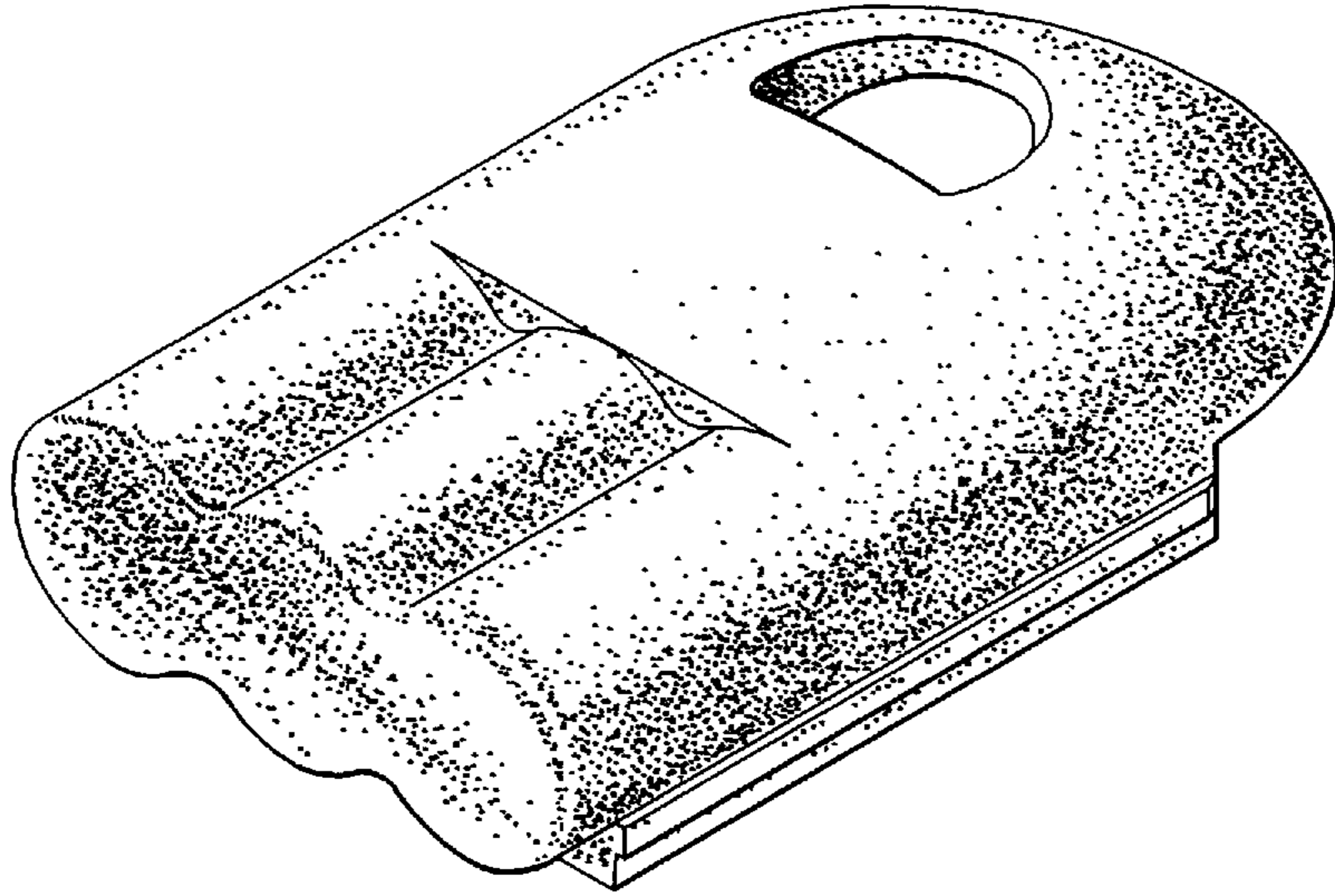

FIG. 2

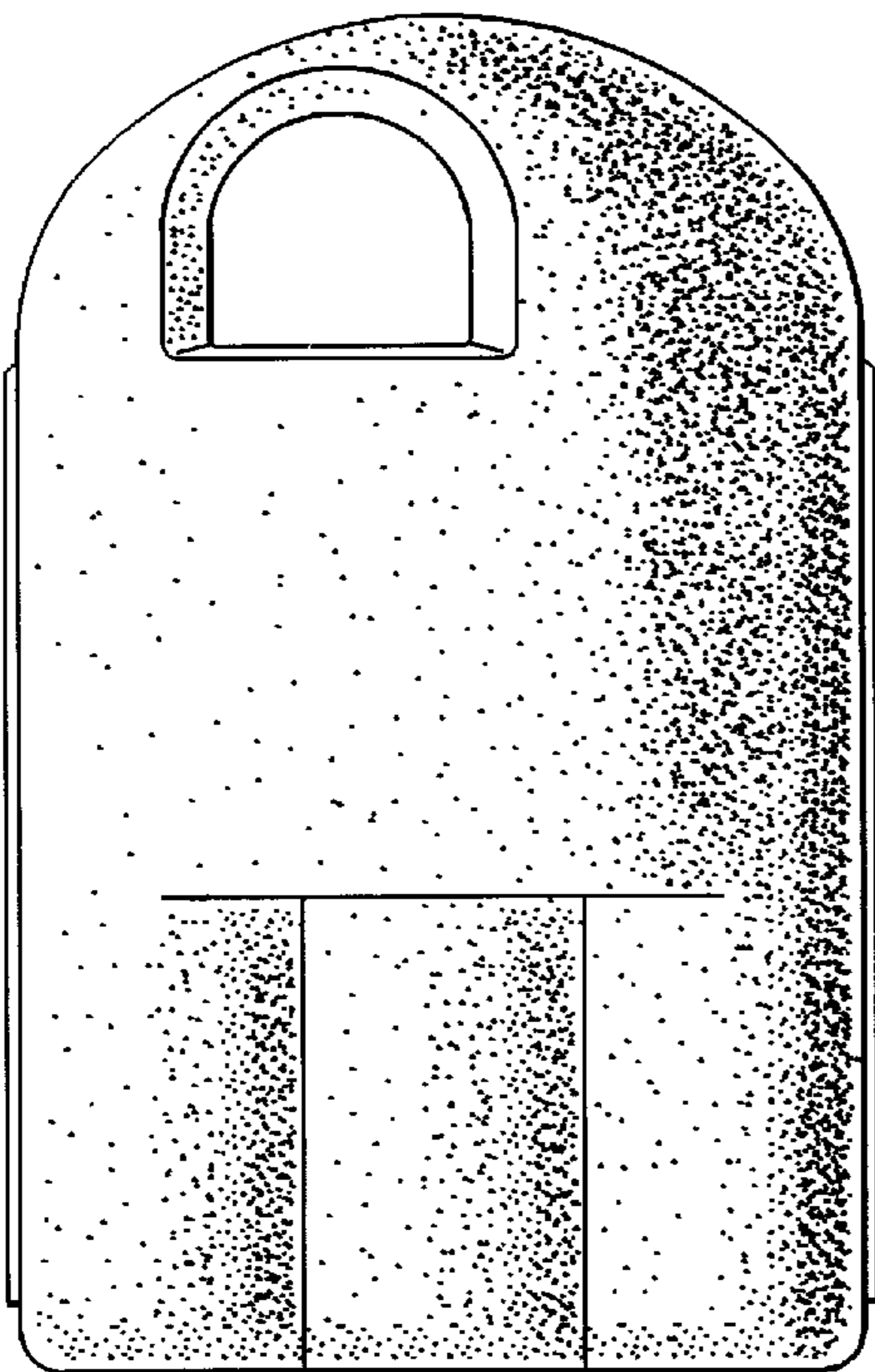

FIG. 3

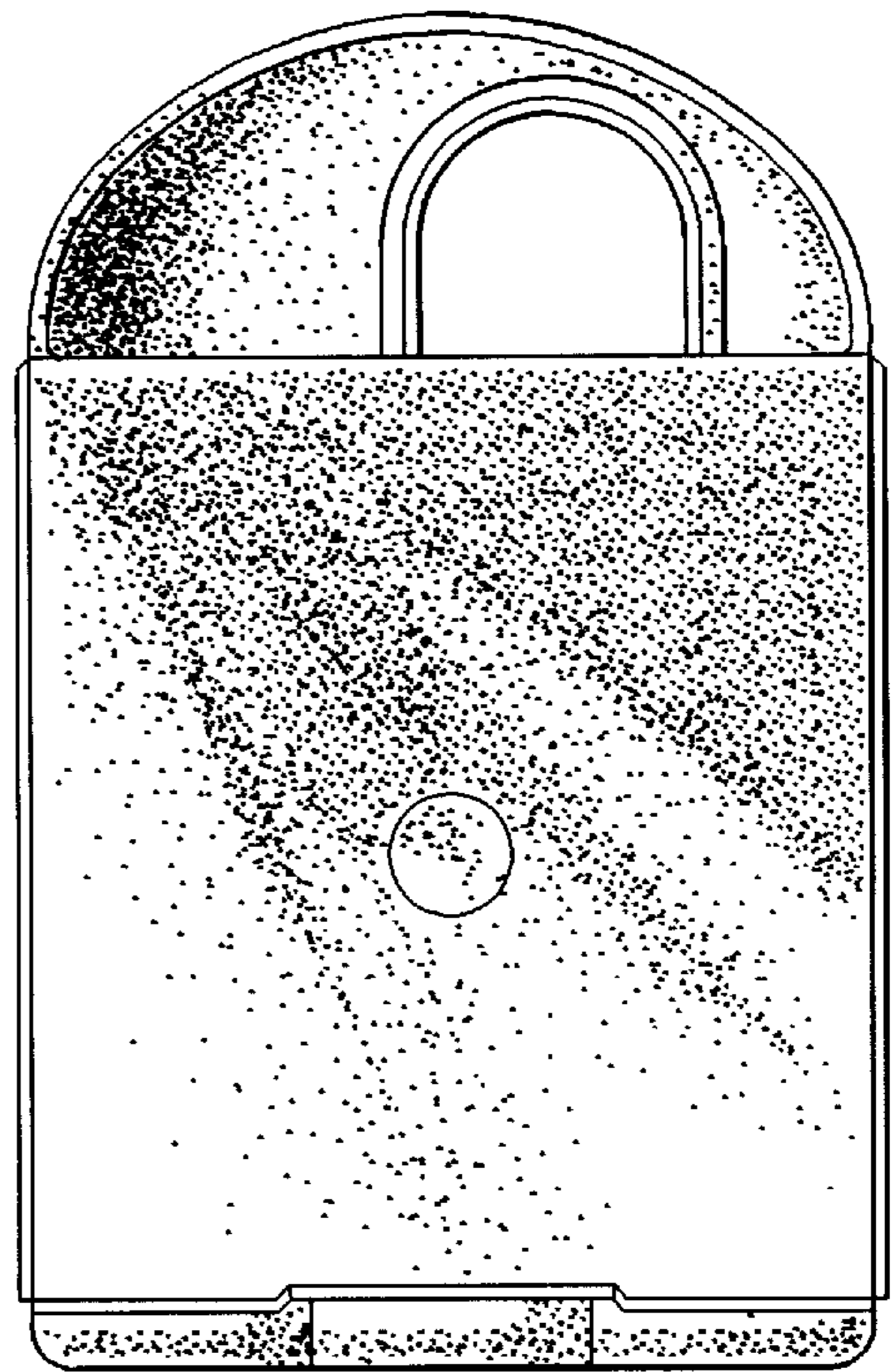

FIG. 4

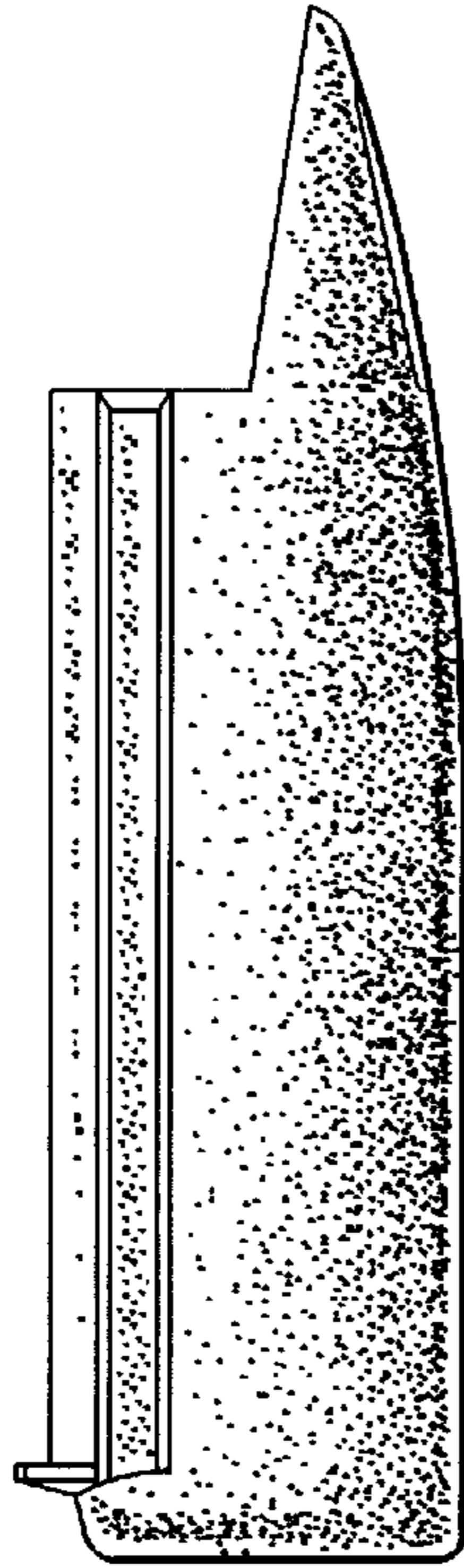

FIG. 5

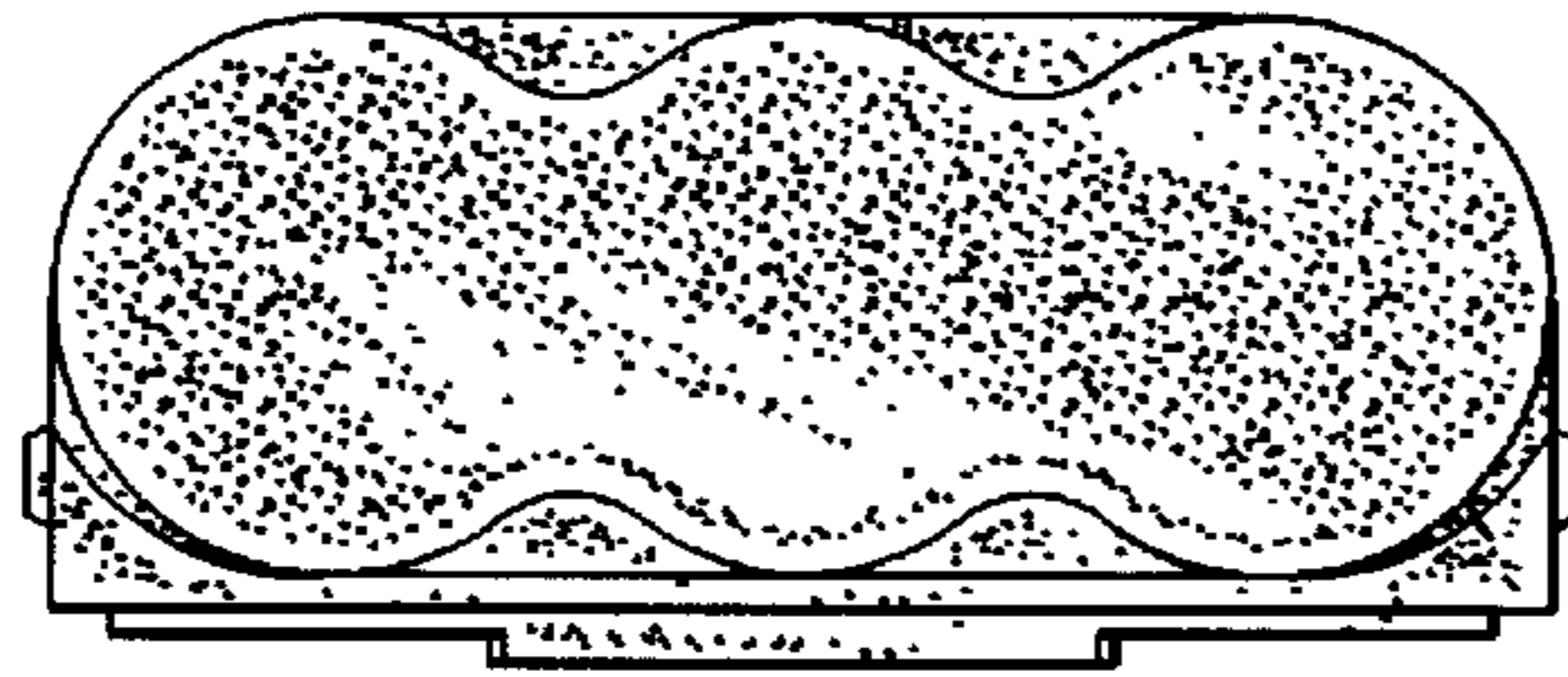
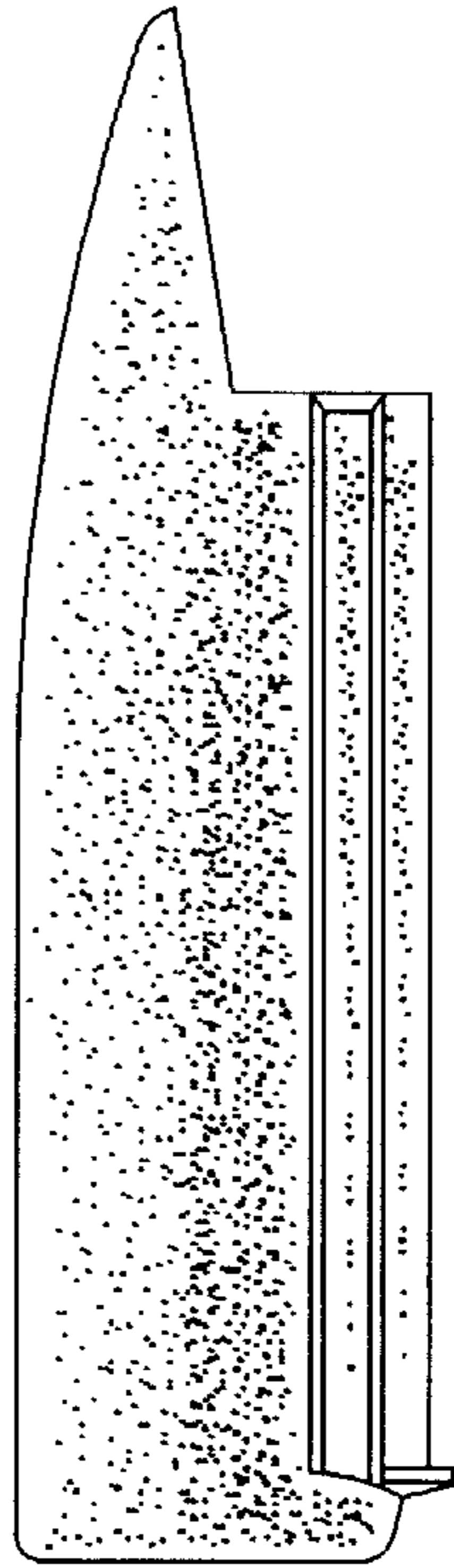
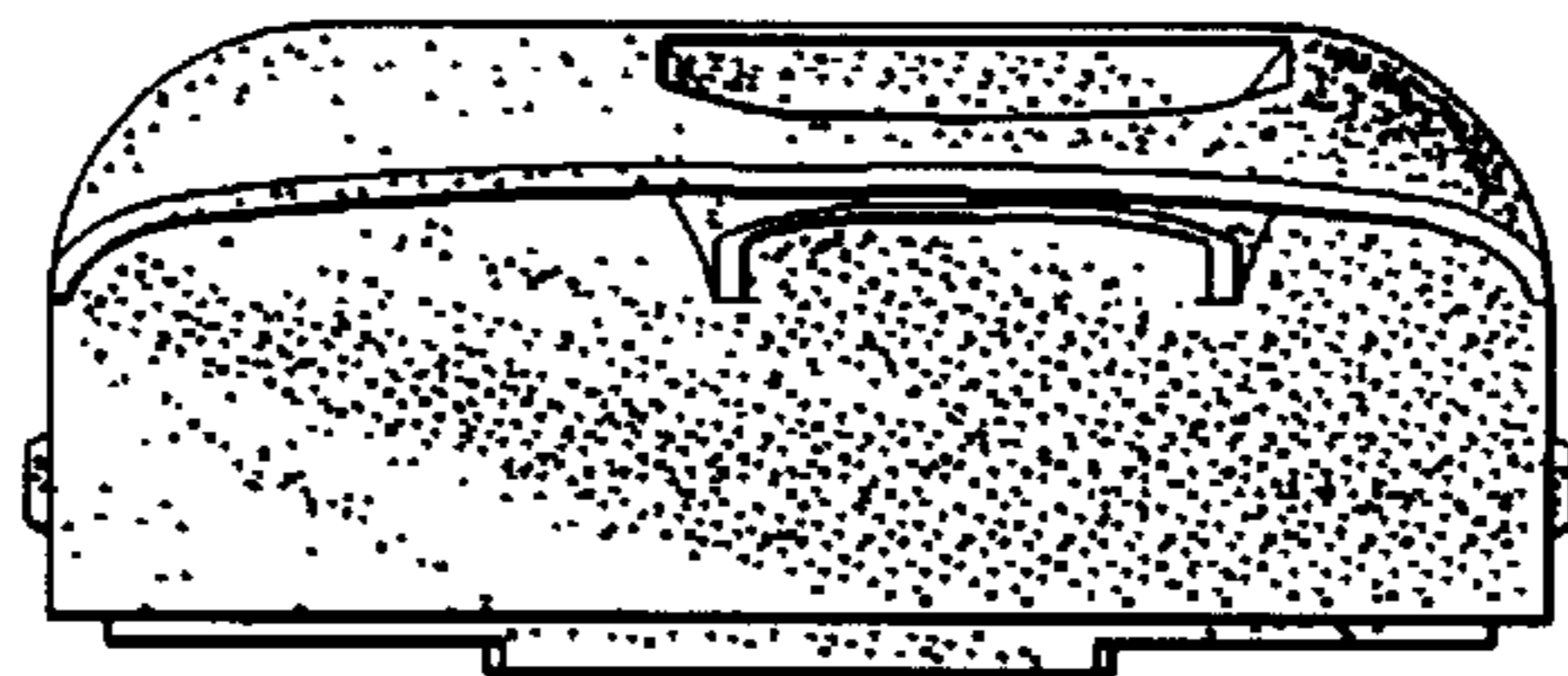

FIG. 6

FIG. 7



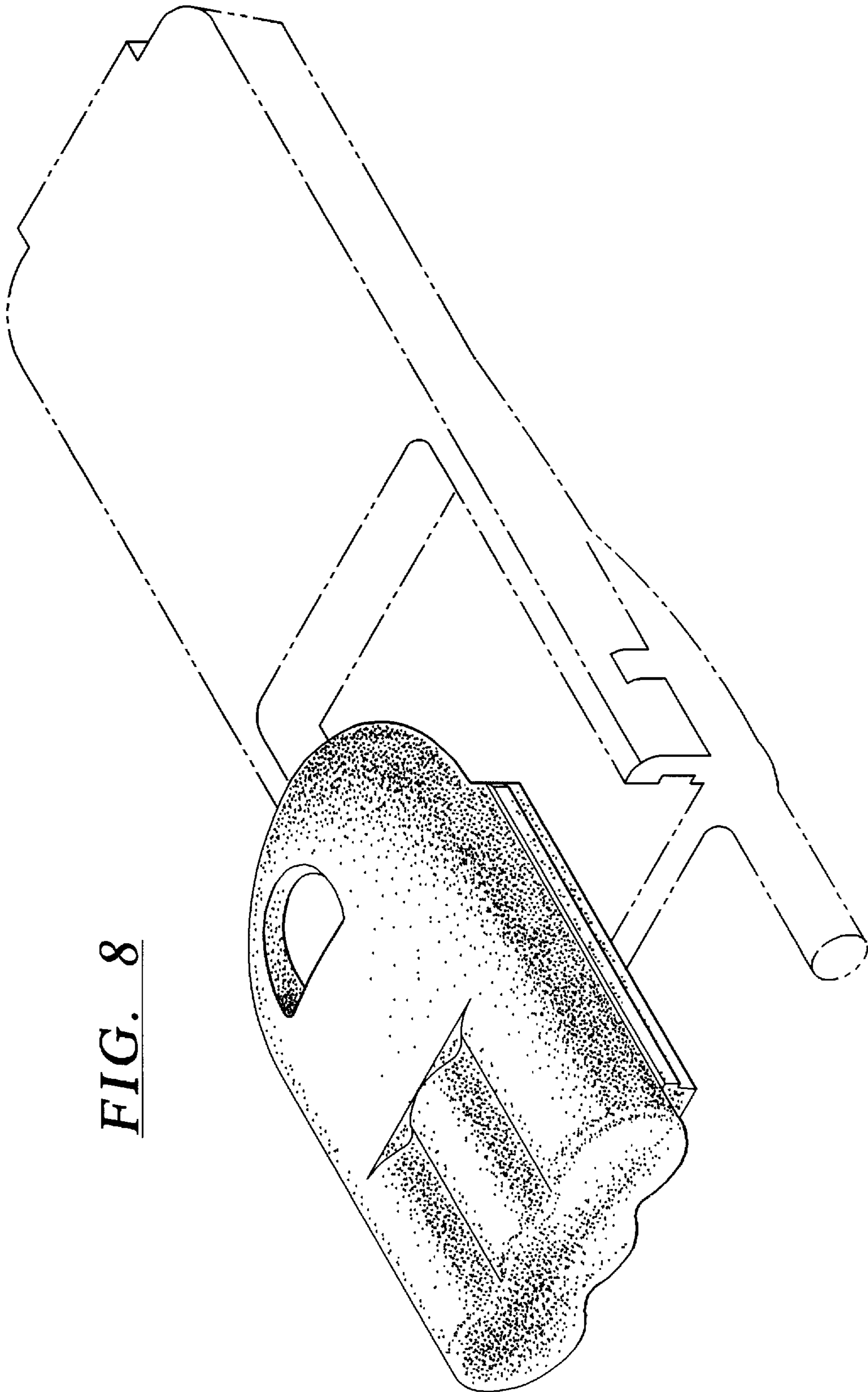

FIG. 8