



US00D406236S

United States Patent [19]

Brifcani et al.

[11] Patent Number: Des. 406,236

[45] Date of Patent: **Mar. 2, 1999

[54] CAN END

[75] Inventors: **Mouayed Mamdooh Brifcani**,
Oxfordshire; **Peter James Hinton**,
Wiltshire; **Mark Christopher Kysh**,
Oxfordshire, all of Great Britain

[73] Assignee: **Crown Cork & Seal Technologies Corporation**, Alsip, Ind.

[**] Term: **14 Years**

[21] Appl. No.: **52,695**

[22] Filed: **Apr. 4, 1996**

[30] Foreign Application Priority Data

Oct. 5, 1995 [GB] United Kingdom 2050968
Oct. 5, 1995 [GB] United Kingdom 2050969

[51] LOC (6) Cl. **09-07**

[52] U.S. Cl. **D9/438**

[58] Field of Search D9/434, 435, 438,
D9/499, 518; 215/255; 220/269-271; 222/541.9

[56] References Cited

U.S. PATENT DOCUMENTS

D. 279,265 6/1985 Turner et al. D9/438
D. 285,661 9/1986 Brownbill D9/438 X
D. 300,608 4/1989 Taylor et al. D9/438
D. 304,302 10/1989 Dalli et al. D9/438
D. 337,521 7/1993 McNulty D9/438
D. 347,172 5/1994 Heynan et al. D9/518 X
D. 352,898 11/1994 Vacher D9/438
4,217,843 8/1980 Kraska .
4,286,728 9/1981 Frazee et al. 220/270
4,674,649 6/1987 Pavely 220/271
4,685,582 8/1987 Pulciani et al. D9/518 X
4,893,725 1/1990 Ball et al. 220/271 X
5,494,184 2/1996 Noguchi et al. 220/271 X

FOREIGN PATENT DOCUMENTS

0 153 115 A3 8/1985 European Pat. Off. .

2 196 891 5/1988 United Kingdom .
2 218 024 11/1989 United Kingdom .
WO 93/17864 9/1993 WIPO .

Primary Examiner—Jeffrey Asch
Assistant Examiner—Cathron B. Matta
Attorney, Agent, or Firm—Burns Doane Swecker & Mathis L.L.P.

[57] CLAIM

The ornamental design for a can end, as shown and described.

DESCRIPTION

FIG. 1 is a front top perspective view of our new design for a can end;

FIG. 2 is a top plan view of FIG. 1;

FIG. 3 is a bottom plan view of FIG. 1;

FIG. 4 is a side view of FIG. 1 (all side views correspond to FIG. 4);

FIG. 5 is a front top perspective view of a second embodiment of the can end of FIG. 1 showing the can tab in broken lines;

FIG. 6 is a top plan view of FIG. 5;

FIG. 7 is a bottom plan view of FIG. 5;

FIG. 8 is a side view of FIG. 5 (all side views correspond to FIG. 8); and

FIG. 9 is a front top perspective view of the can end of FIG. 5, shown in a final position of use when attached to a can body;

FIG. 10 is a top plan view of FIG. 9;

FIG. 11 is a side view of FIG. 9; and,

FIG. 12 is a fragmentary sectional view taken along the line 12—12 in FIG. 10.

The broken line showing of a can tab in FIGS. 5–12 and the broken line showing of a can body in FIGS. 9–12 are for illustrative purposes only and forms no part of the claimed design.

1 Claim, 6 Drawing Sheets

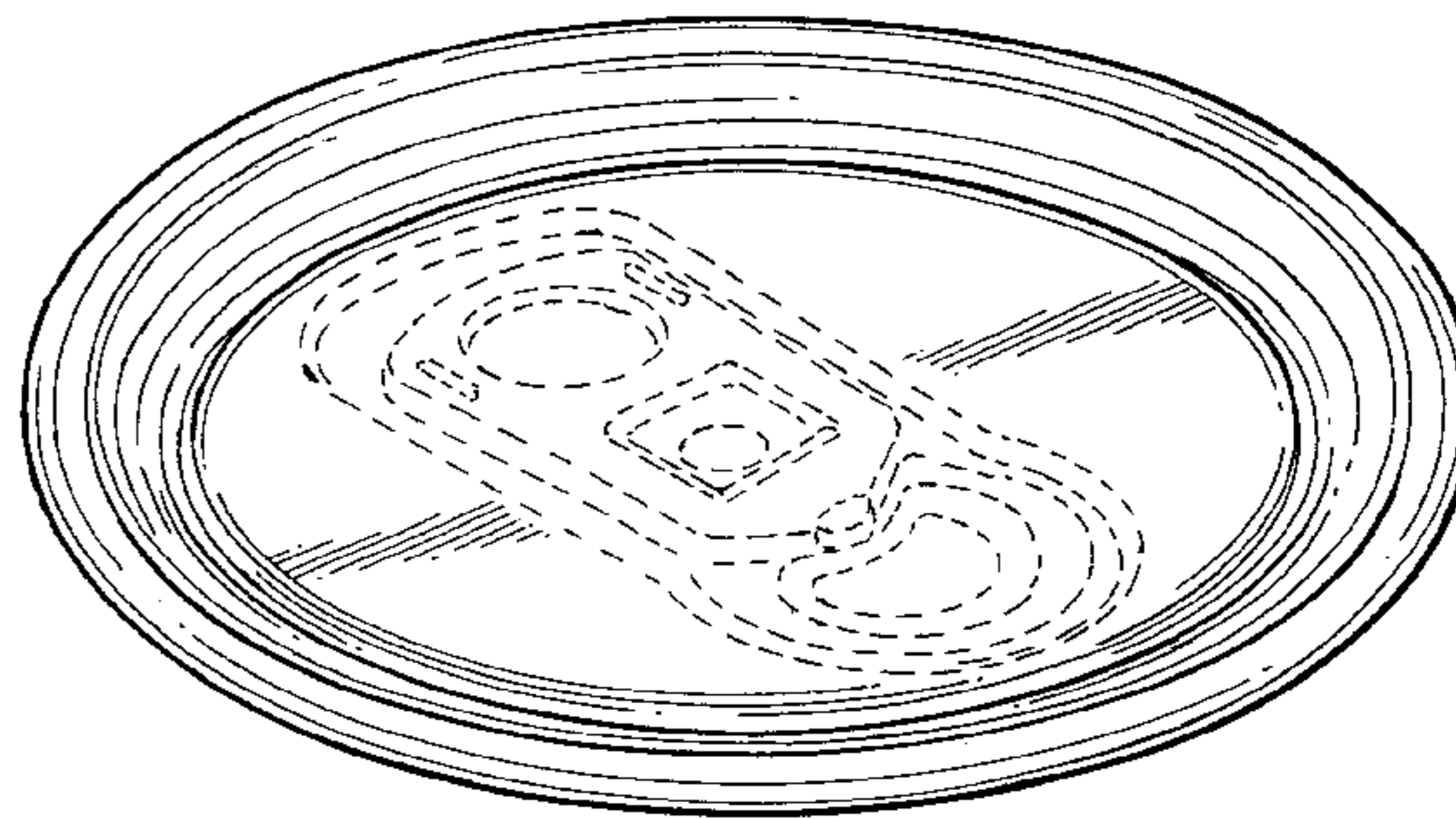
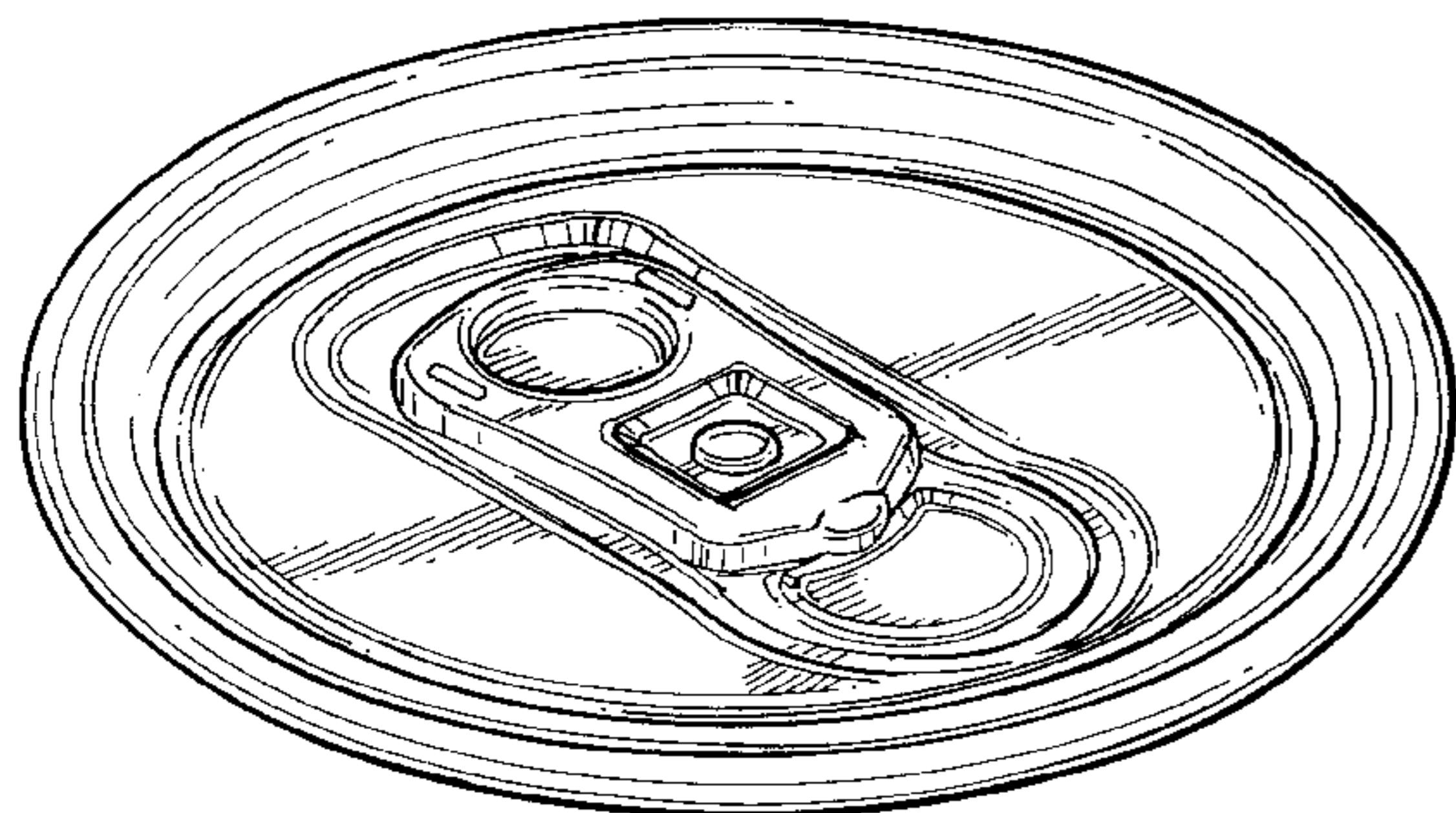

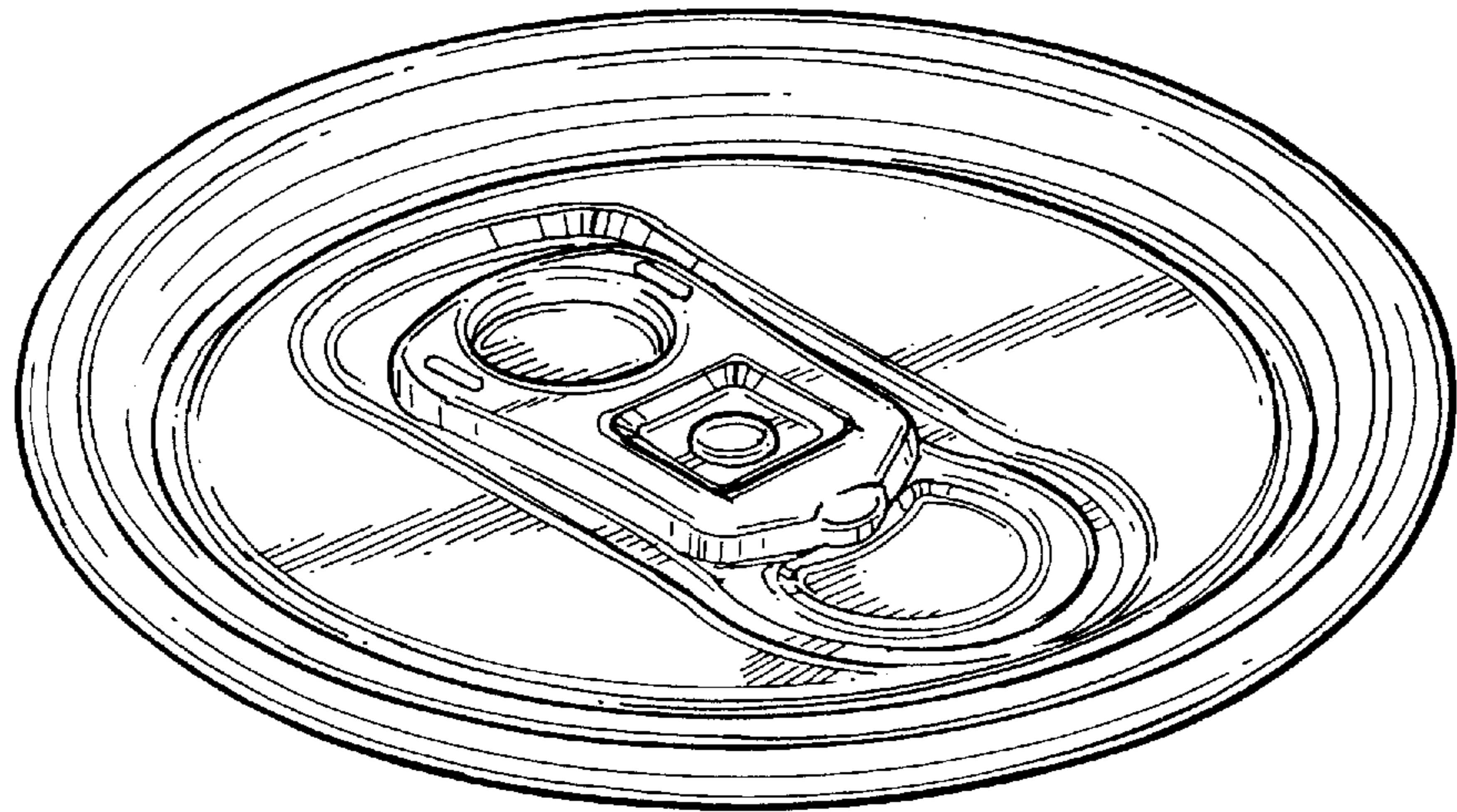

FIG. 1

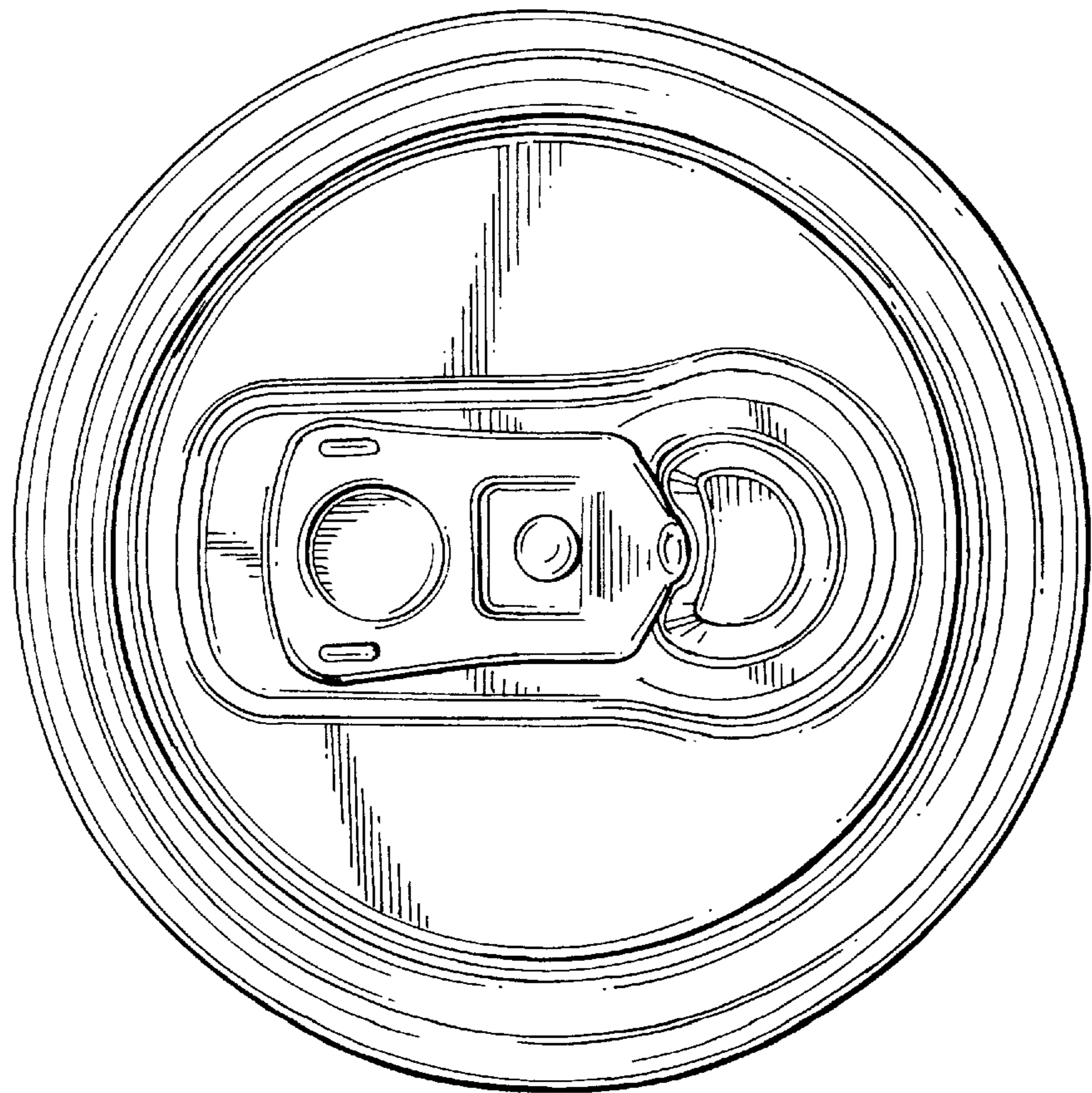

FIG. 2

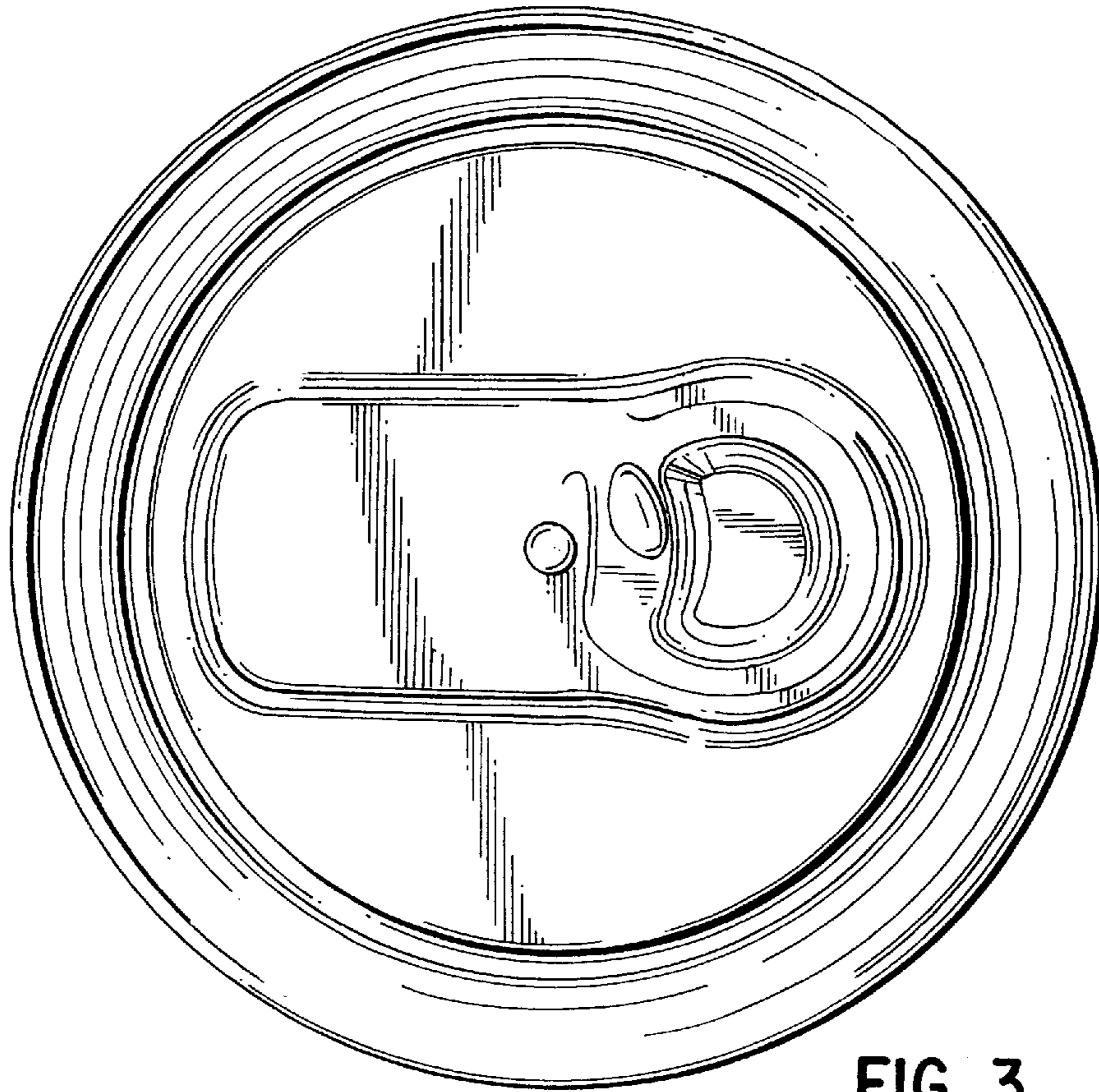

FIG. 3

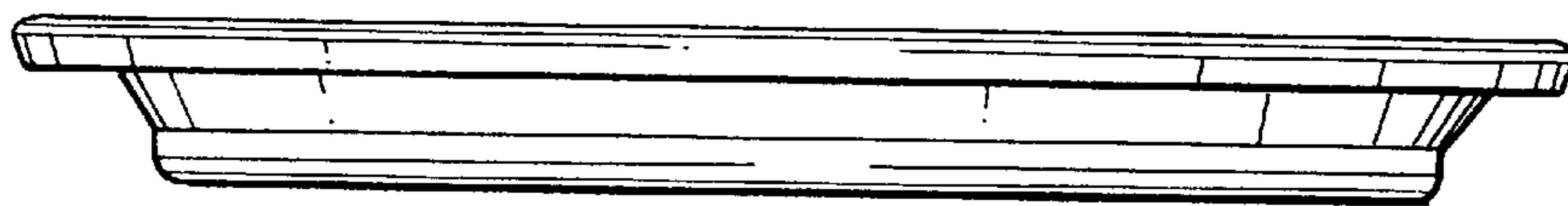

FIG. 4

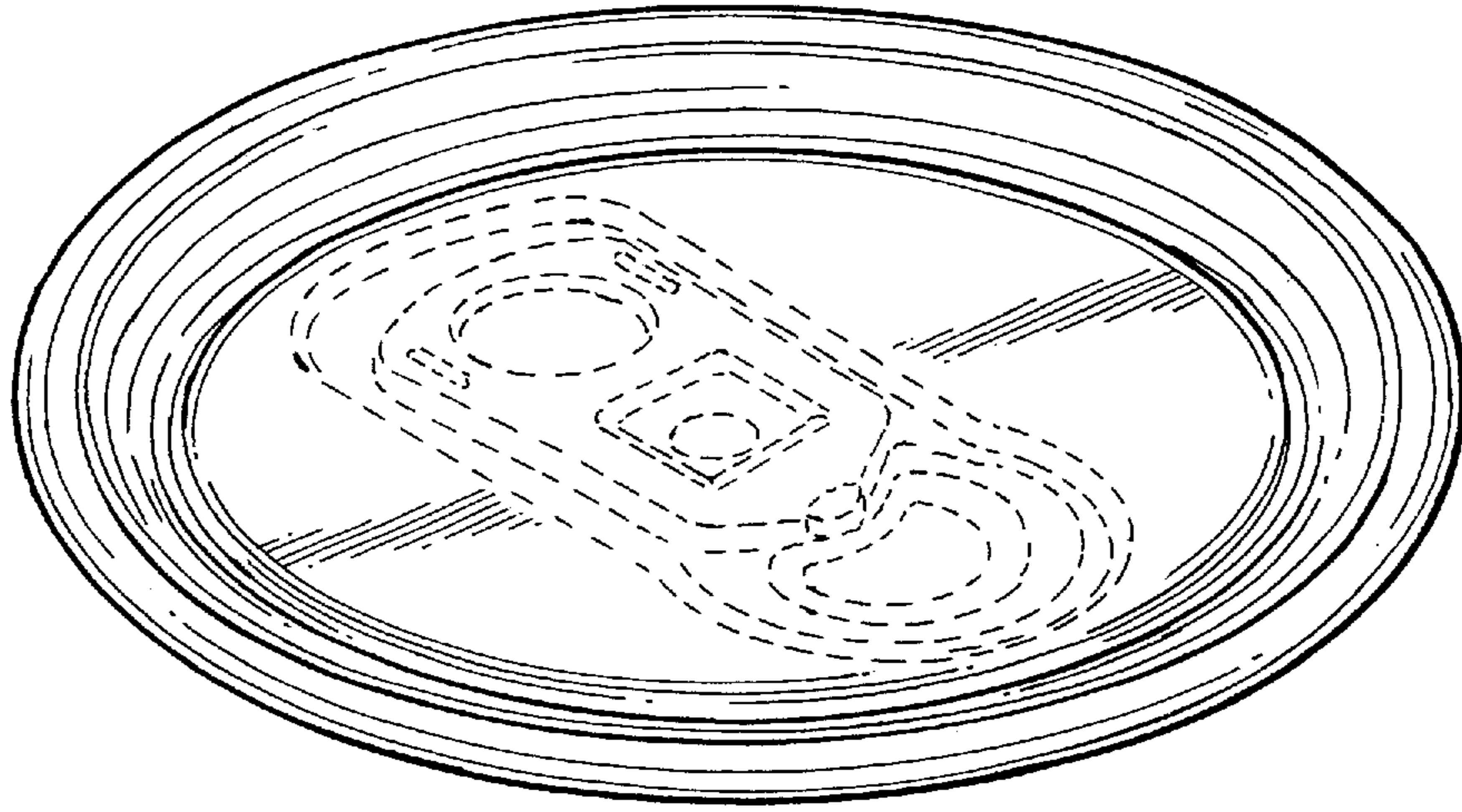

FIG. 5

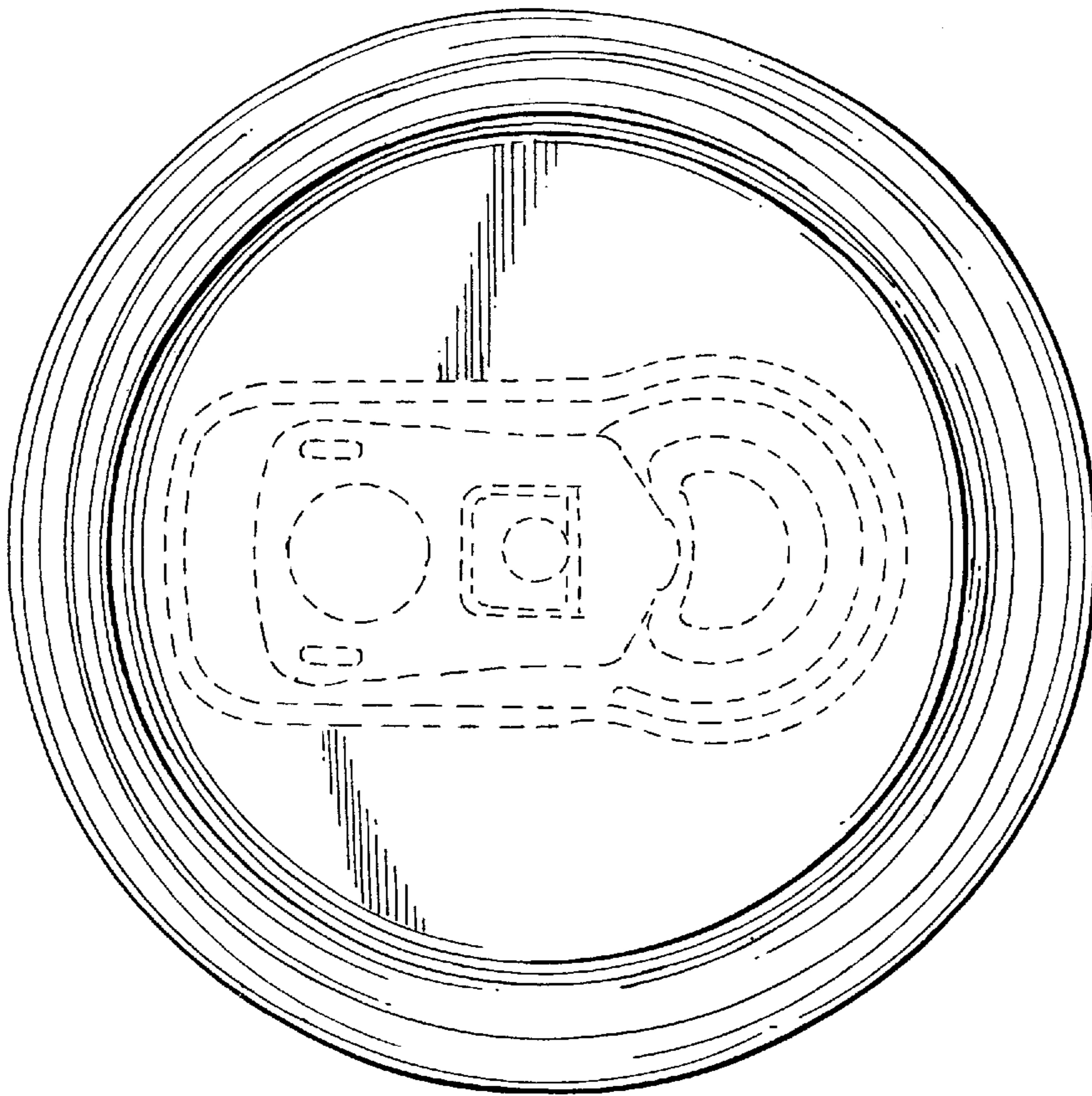

FIG. 6

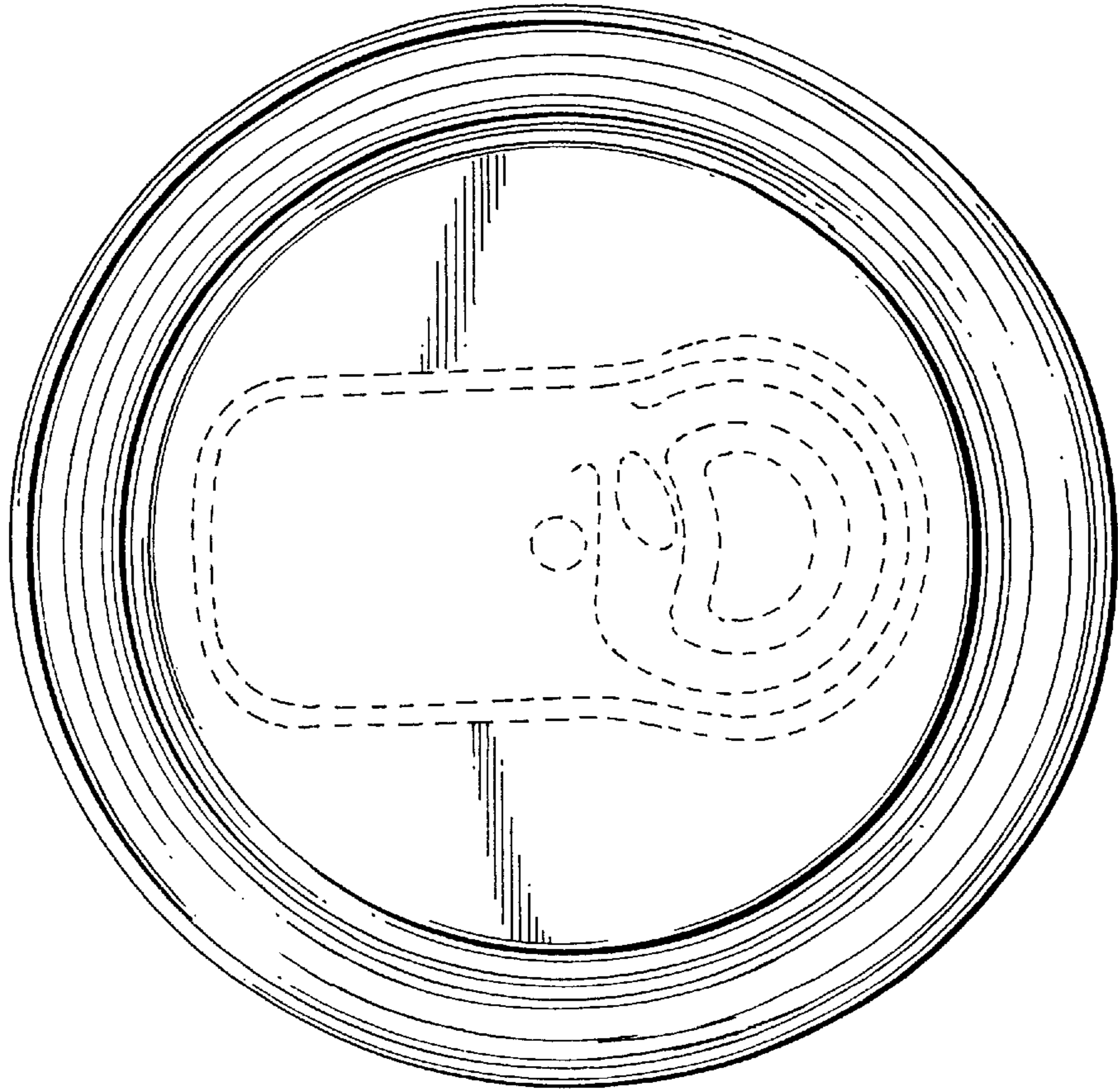

FIG. 7

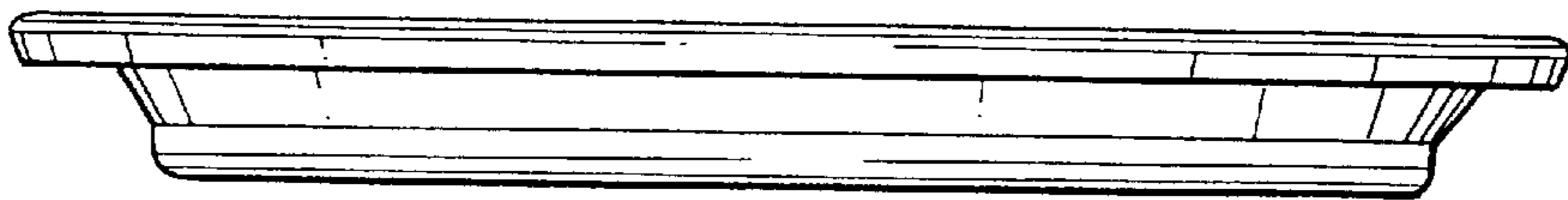

FIG. 8

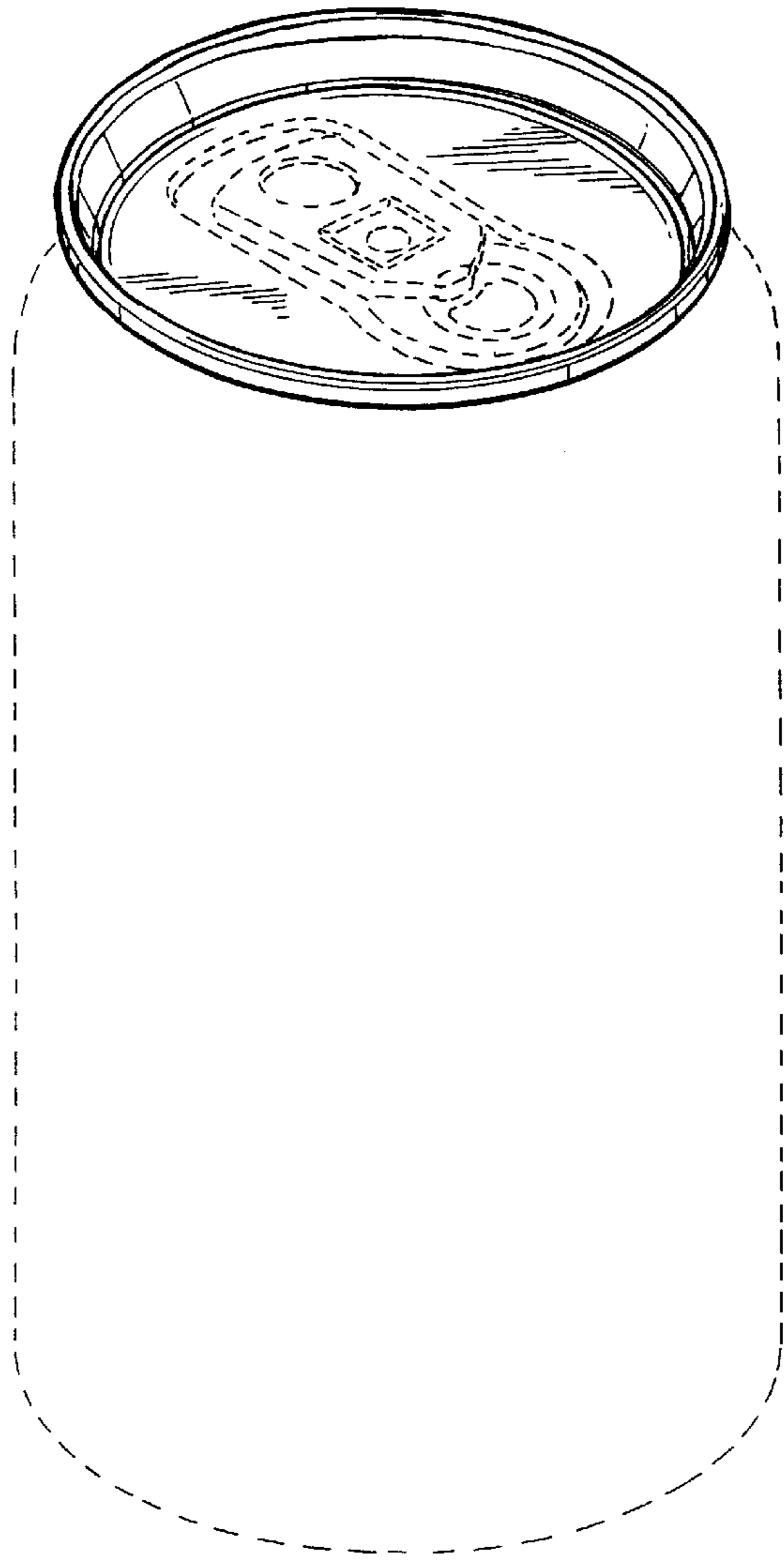

FIG. 9

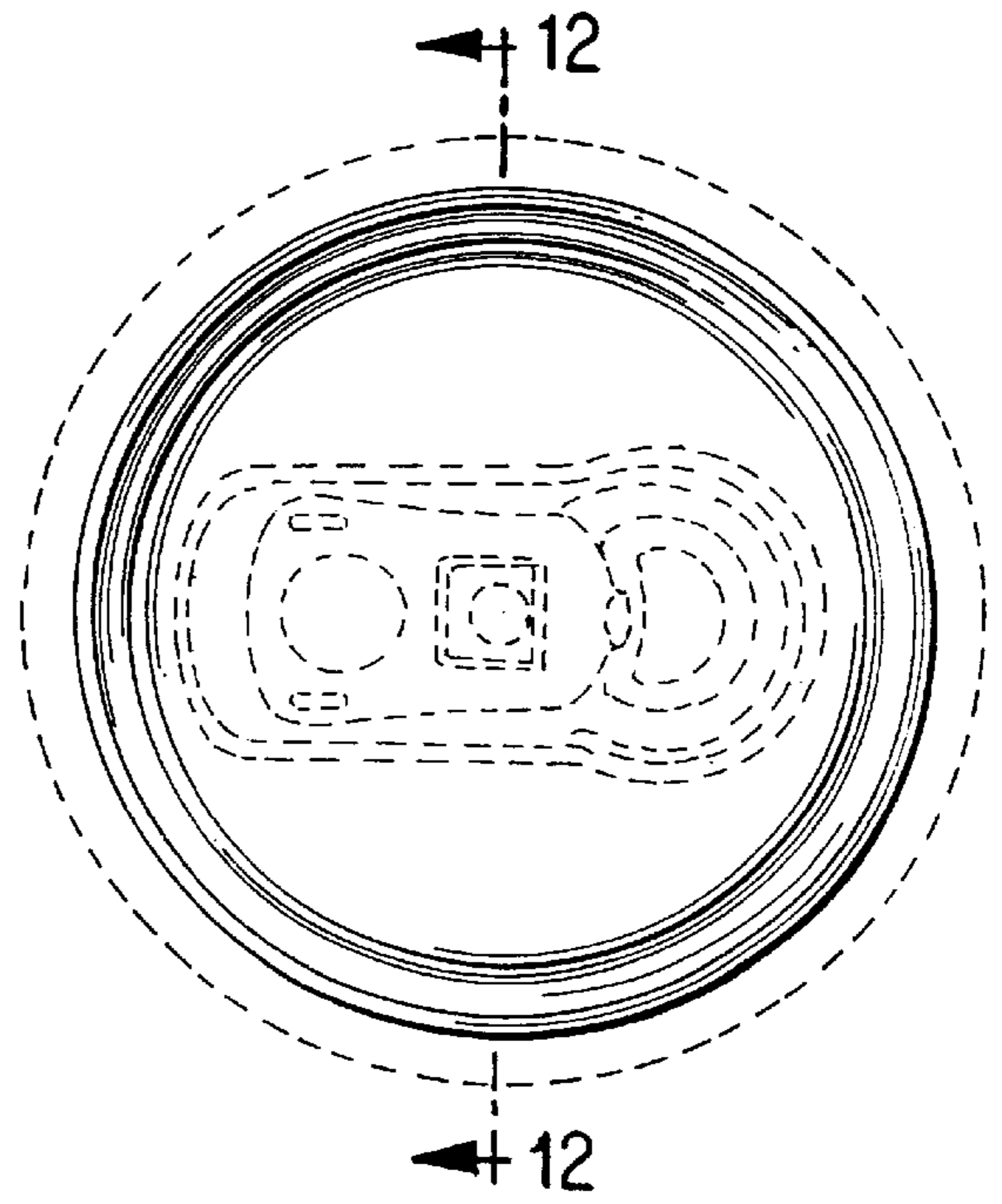

FIG. 10

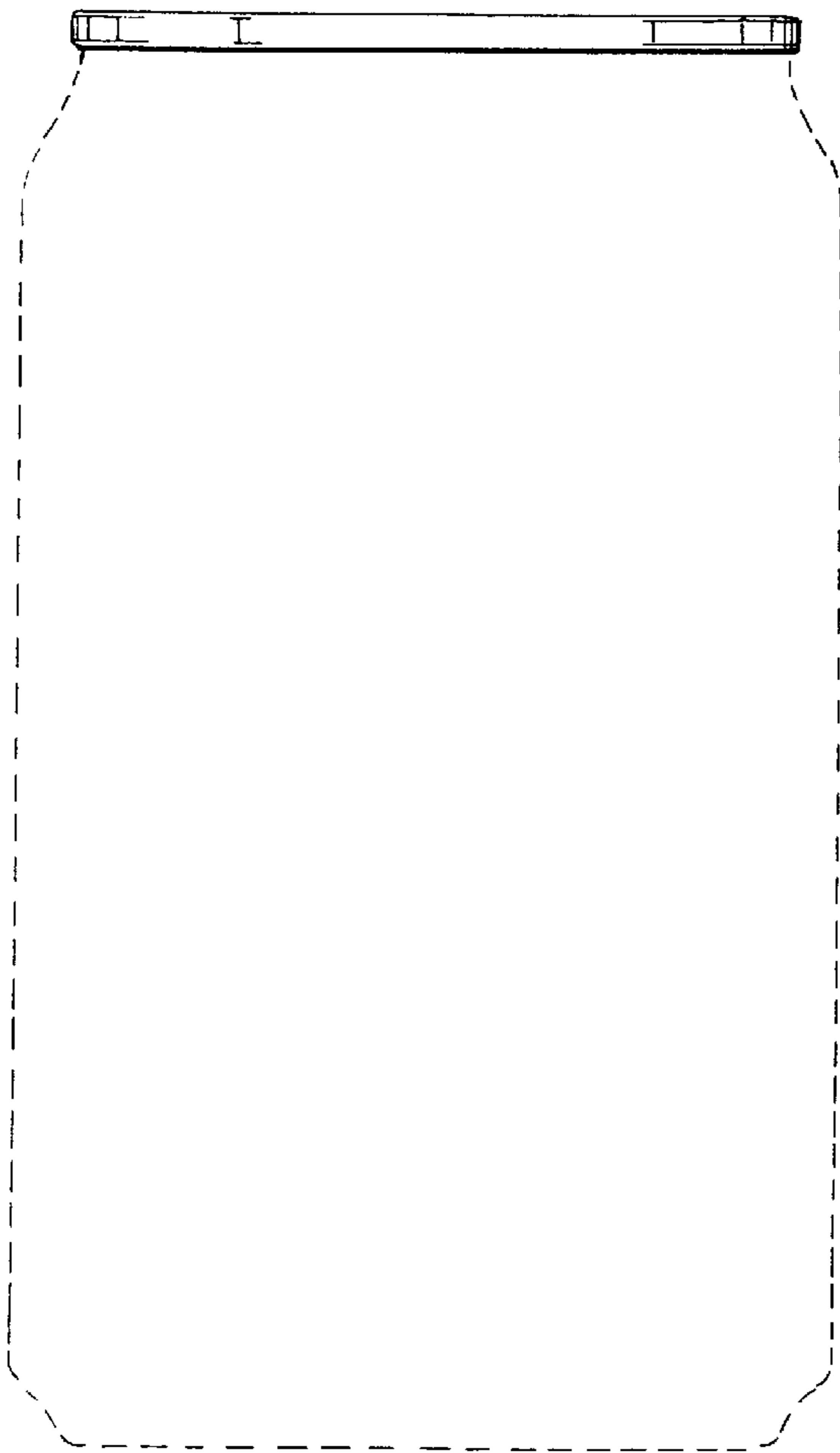

FIG. 11

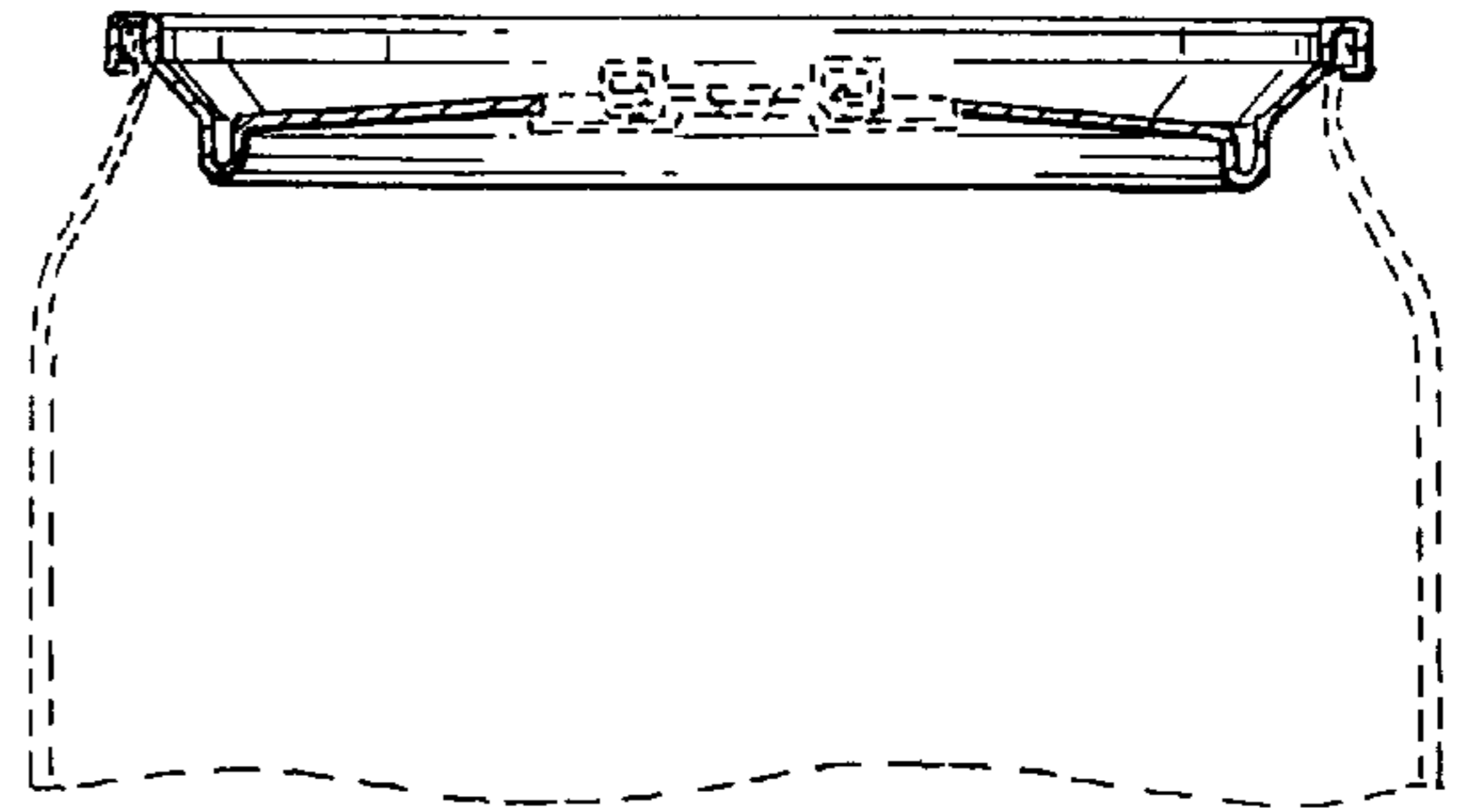

FIG. 12