



US00D406196S

United States Patent [19]
Lyons

[11] **Patent Number: Des. 406,196**

[45] **Date of Patent: **Mar. 2, 1999**

[54] **STACKING CHAIR**

D. 368,383 4/1996 Danko D6/374

[76] Inventor: **Richard Lyons**, Hartwell, Kill, County Kildare, Ireland

Primary Examiner—Gary D. Watson
Attorney, Agent, or Firm—Bacon & Thomas, PLLC

[**] Term: **14 Years**

[57] **CLAIM**

[21] Appl. No.: **74,344**

The ornamental design for a stacking chair, as shown and described.

[22] Filed: **Jul. 31, 1997**

DESCRIPTION

[51] **LOC (6) Cl.** **06-01**

[52] **U.S. Cl.** **D6/375**

[58] **Field of Search** D6/334, 374, 375, D6/376, 380, 500, 501, 502; 297/239, DIG. 2

FIG. 1 is a front perspective view taken from above of a stacking chair showing my new design;
FIG. 2 is a left side elevation view thereof, the right side being a mirror image thereof;
FIG. 3 is a top right perspective view thereof;
FIG. 4 is a lower right perspective view of the bottom thereof;
FIG. 5 is a bottom view thereof;
FIG. 6 is a rear elevation view thereof; and,
FIG. 7 is a front elevation view thereof.

[56] **References Cited**

U.S. PATENT DOCUMENTS

- D. 199,902 12/1964 Petersen D6/374
- D. 256,970 9/1980 Cassina D6/334
- D. 336,795 6/1993 Rowe et al. D6/380
- D. 341,038 11/1993 Danko D6/375
- D. 348,788 7/1994 Starck D6/375

1 Claim, 7 Drawing Sheets

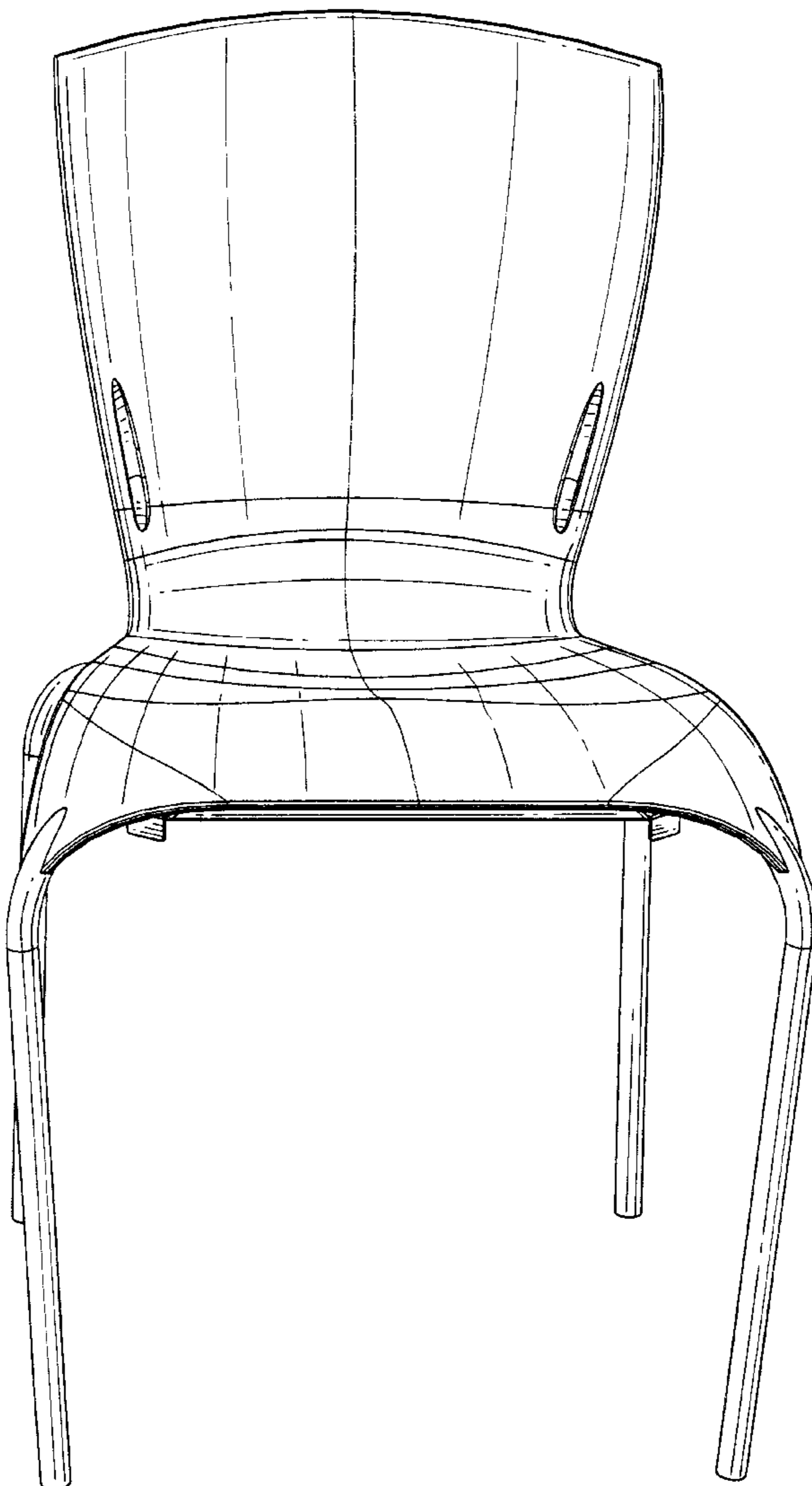

FIG. 1

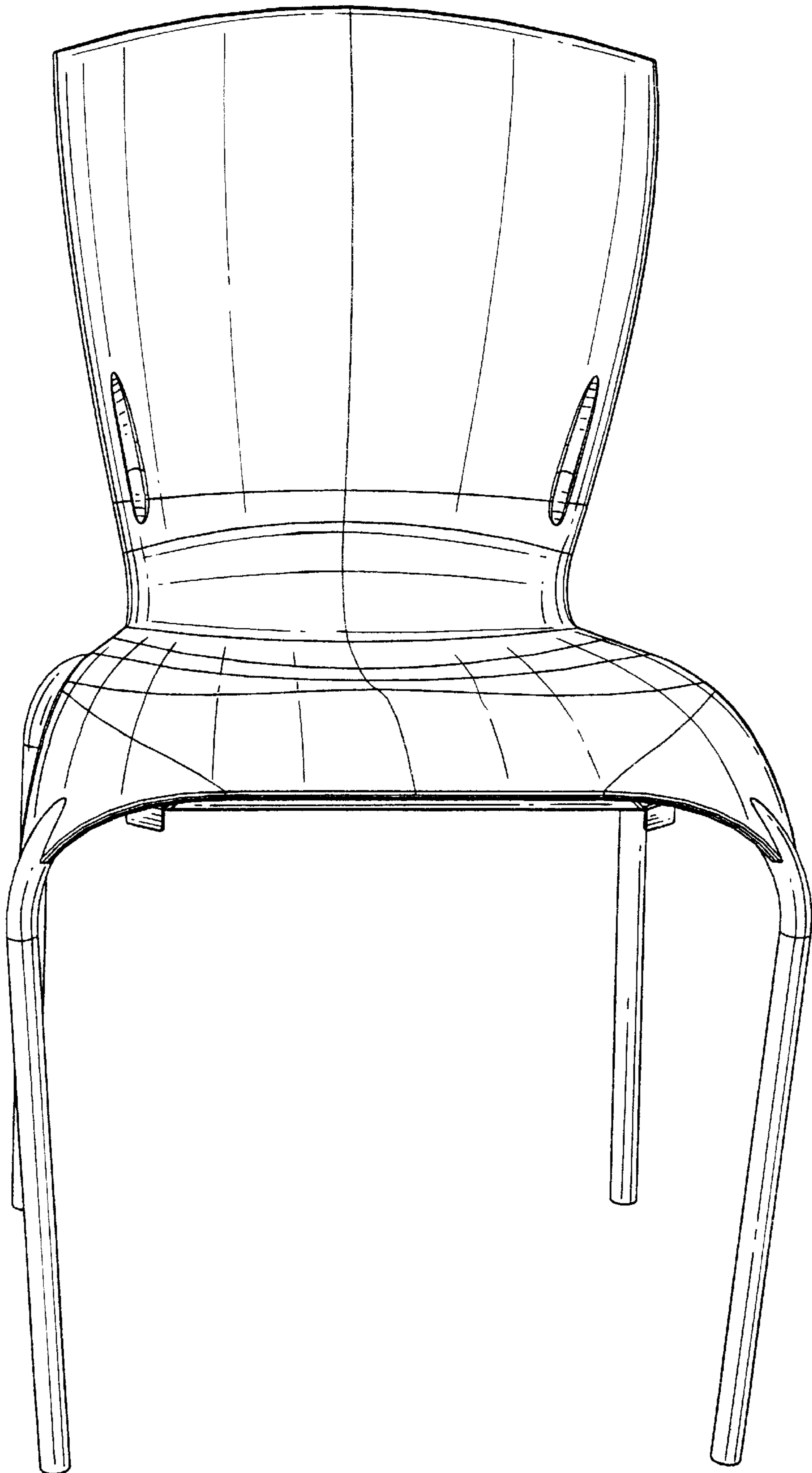
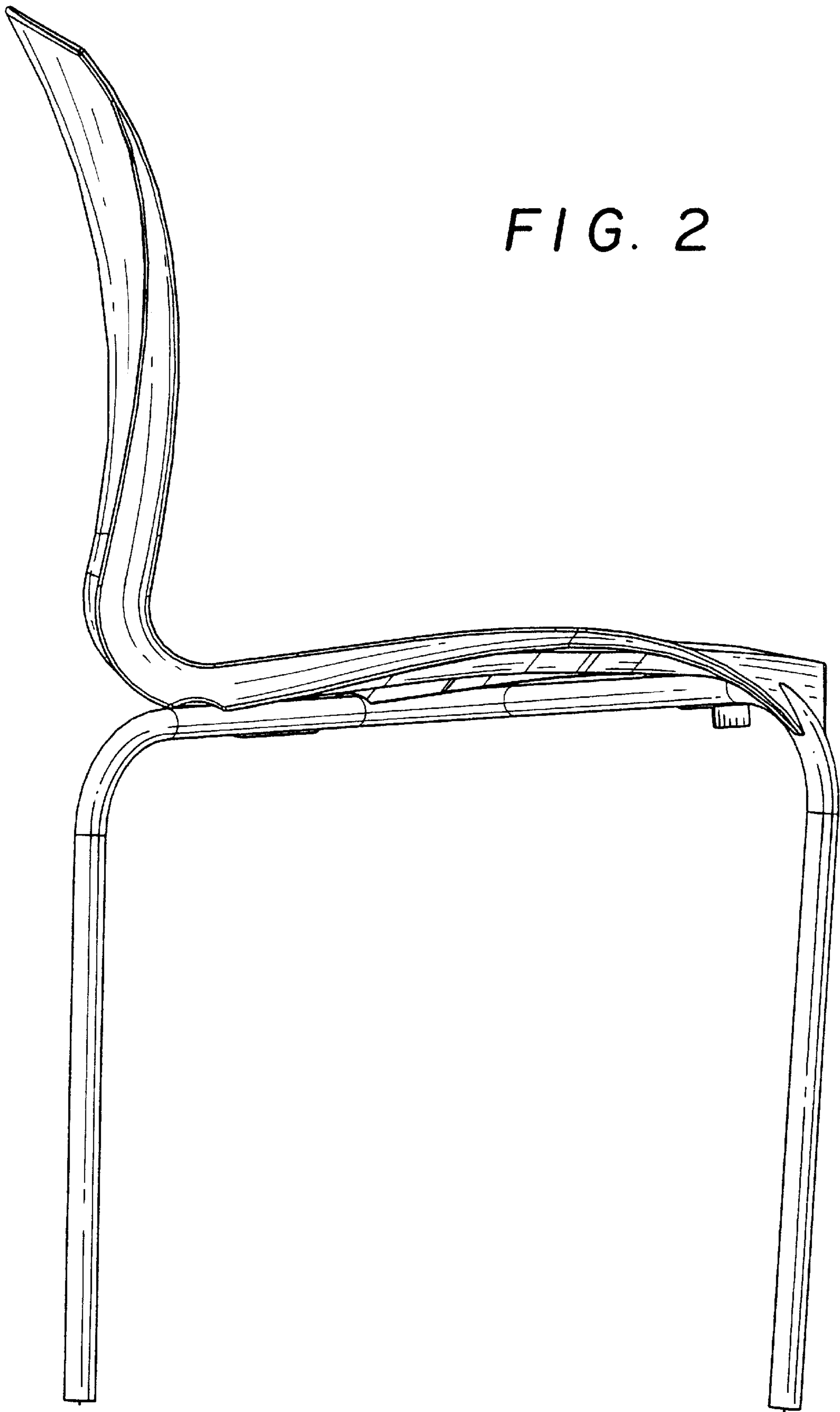

FIG. 2



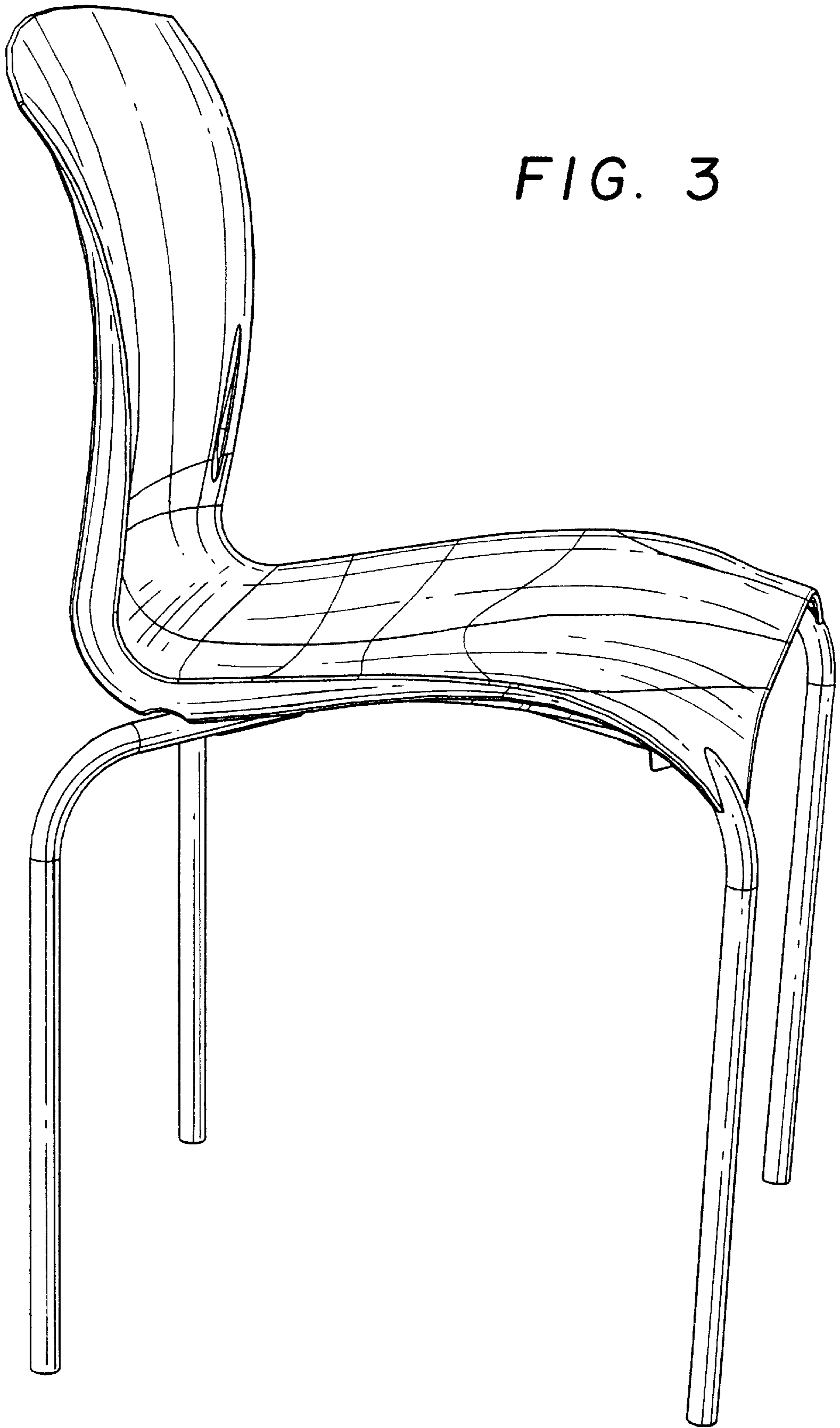

FIG. 3

FIG. 4

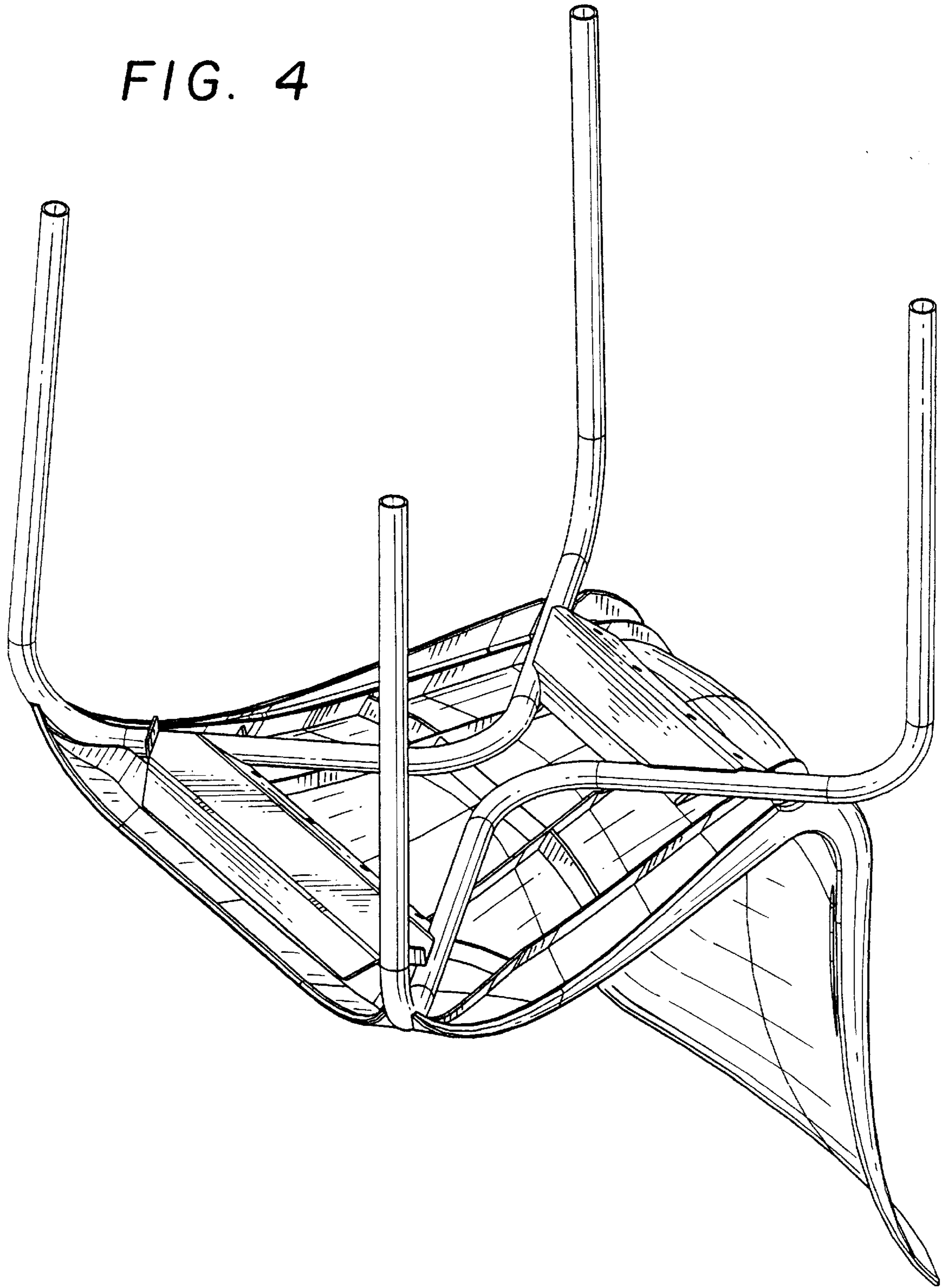
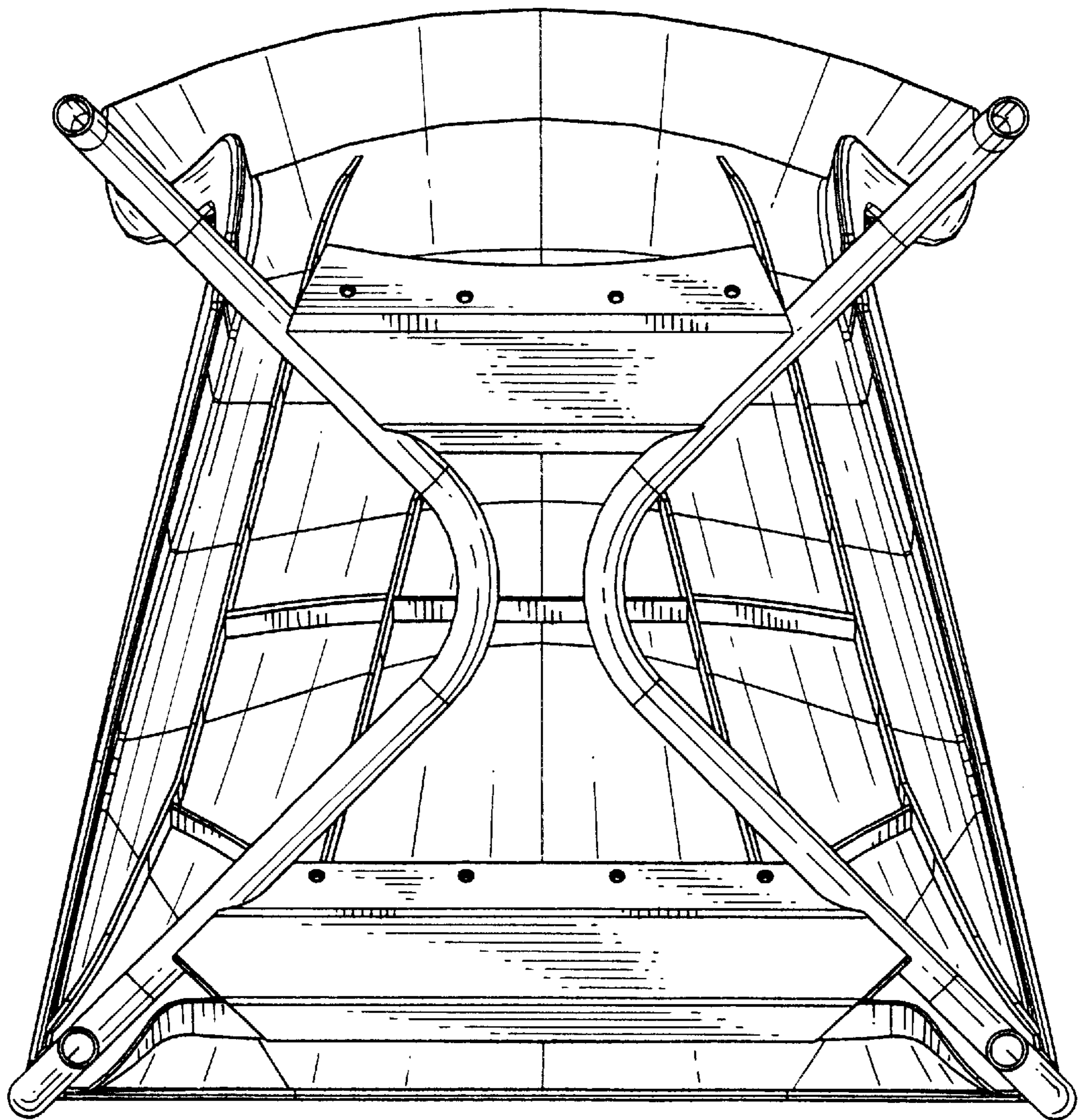

FIG. 5



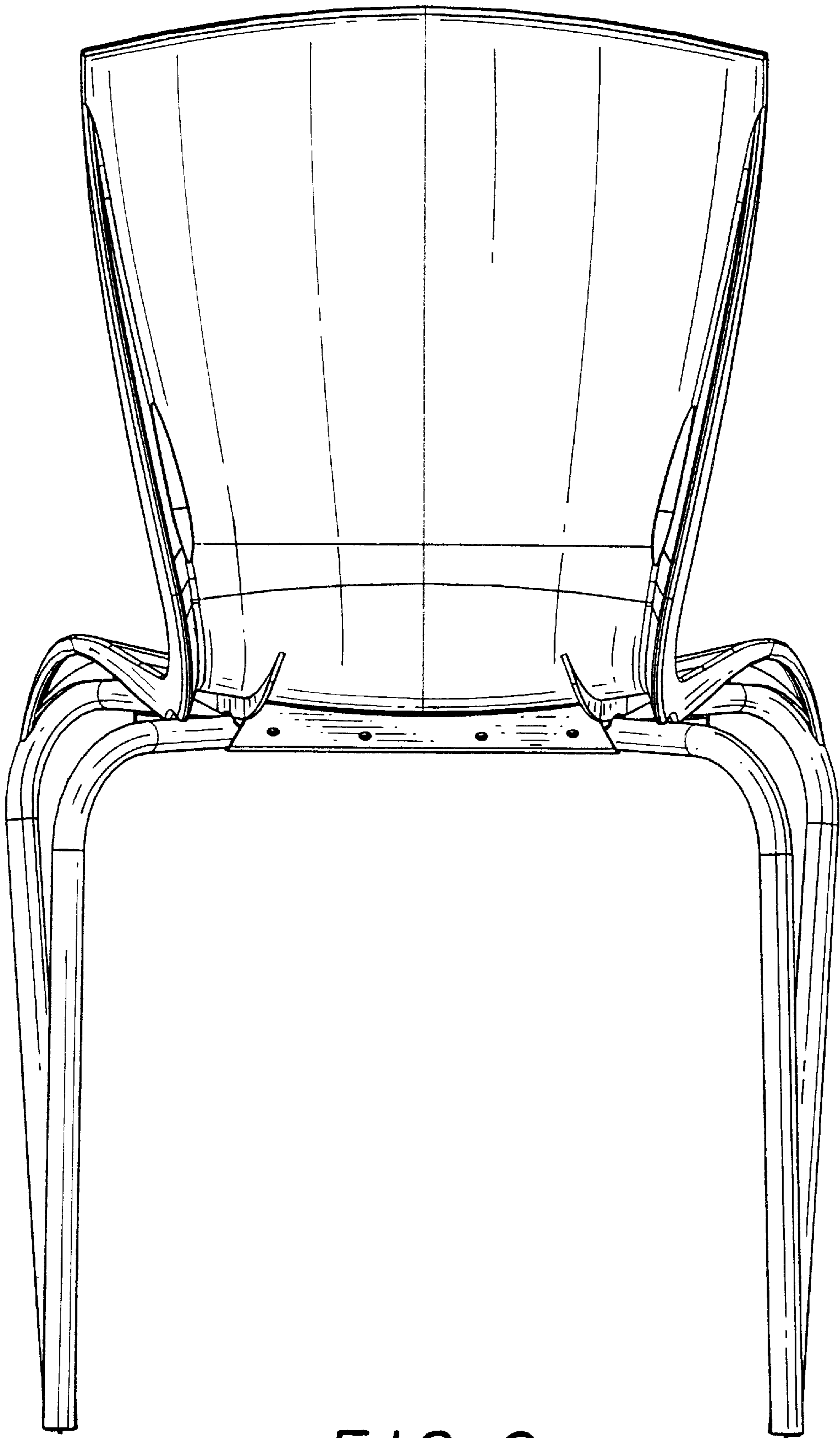

FIG. 6

FIG. 7

