



US00D406191S

United States Patent [19]
Phillips et al.

[11] **Patent Number: Des. 406,191**
[45] **Date of Patent: **Mar. 2, 1999**

[54] **CARRIER FOR A WIRELESS COMMUNICATOR**

[75] Inventors: **William Charles Phillips**, Evanston;
David William Trahan, Grayslake;
Iulius Lucaci, Wheeling, all of Ill.

[73] Assignee: **Motorola, Inc.**, Schaumburg, Ill.

[**] Term: **14 Years**

[21] Appl. No.: **81,407**

[22] Filed: **Dec. 31, 1997**

[51] **LOC (6) Cl.** **03-01**

[52] **U.S. Cl.** **D3/218**

[58] **Field of Search** D3/218, 215; D14/138,
D14/251, 253; 379/454, 455, 446, 447;
455/89, 90, 128; D13/107, 108

[56] **References Cited**

U.S. PATENT DOCUMENTS

D. 367,065	2/1996	Wu	D14/253
D. 369,359	4/1996	Wright et al.	D14/253
D. 381,664	7/1997	Williams et al.	D3/218 X
D. 387,199	12/1997	Nagele et al.	D3/218
D. 392,097	3/1998	Pottala	D3/218
D. 392,646	3/1998	Takayasu et al.	D14/253
5,755,367	5/1998	Yamada	224/245

Primary Examiner—Louis S. Zarfaz
Assistant Examiner—Catherine R. Oliver
Attorney, Agent, or Firm—Lalita P. Williams

[57] **CLAIM**

We claim the ornamental design for the carrier for a wireless communicator, as shown and described.

DESCRIPTION

FIG. 1 is a bottom, right and front perspective view of the first embodiment of a carrier for a wireless communicator showing our new design;

FIG. 2 is a top plan view thereof;

FIG. 3 is a right side elevational view thereof;

FIG. 4 is a rear elevational view thereof;

FIG. 5 is a left side elevational view thereof;

FIG. 6 is a front elevational view thereof;

FIG. 7 is a bottom plan view thereof;

FIG. 8 is a bottom, right and front perspective view of the second embodiment;

FIG. 9 is a top plan view thereof;

FIG. 10 is a right side elevational view thereof;

FIG. 11 is a rear elevational view thereof;

FIG. 12 is a left side elevational view thereof;

FIG. 13 is a front elevational view thereof; and,

FIG. 14 is a bottom plan view thereof.

The broken lines are for illustrative purposes only and form no part of the first embodiment.

1 Claim, 6 Drawing Sheets

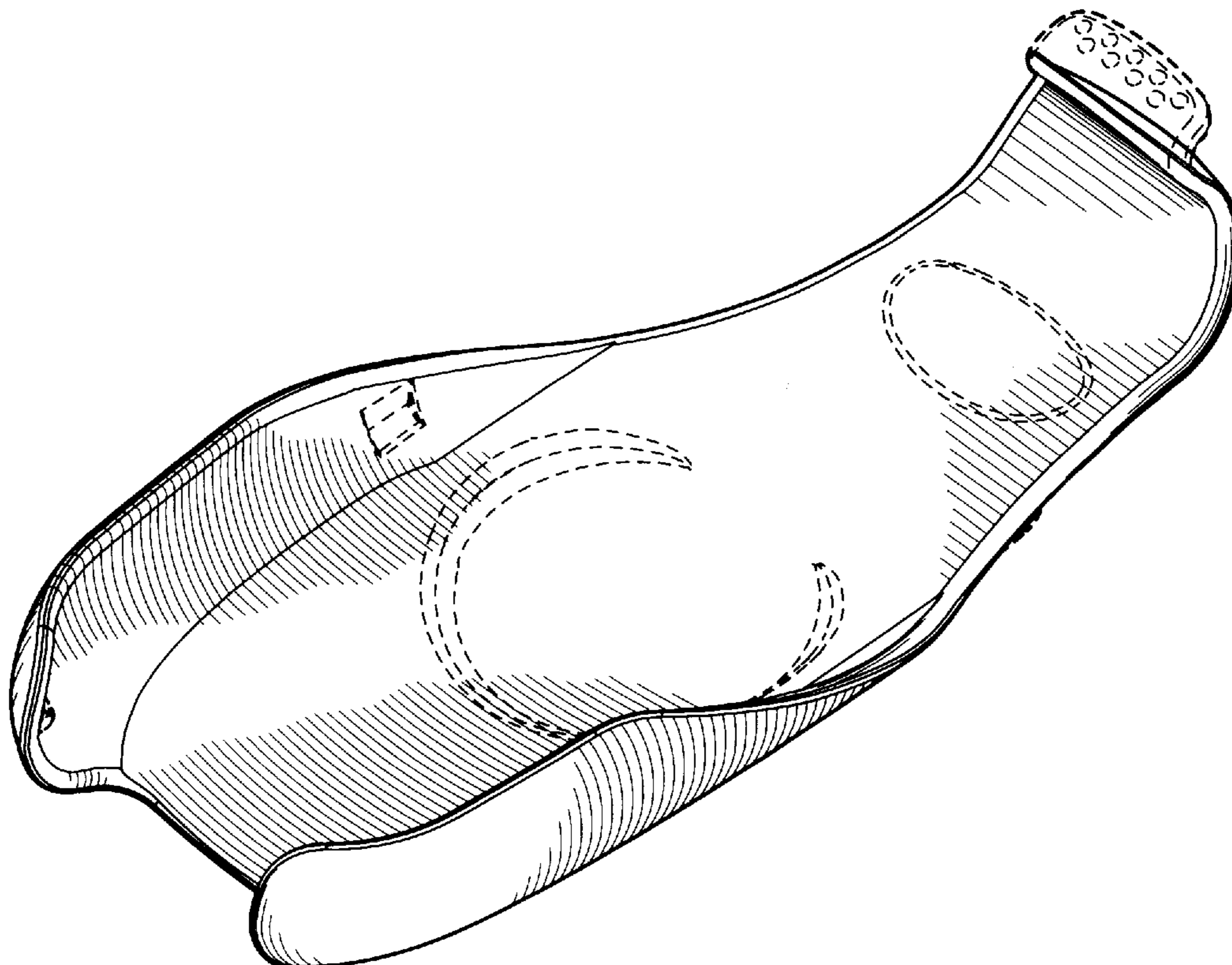

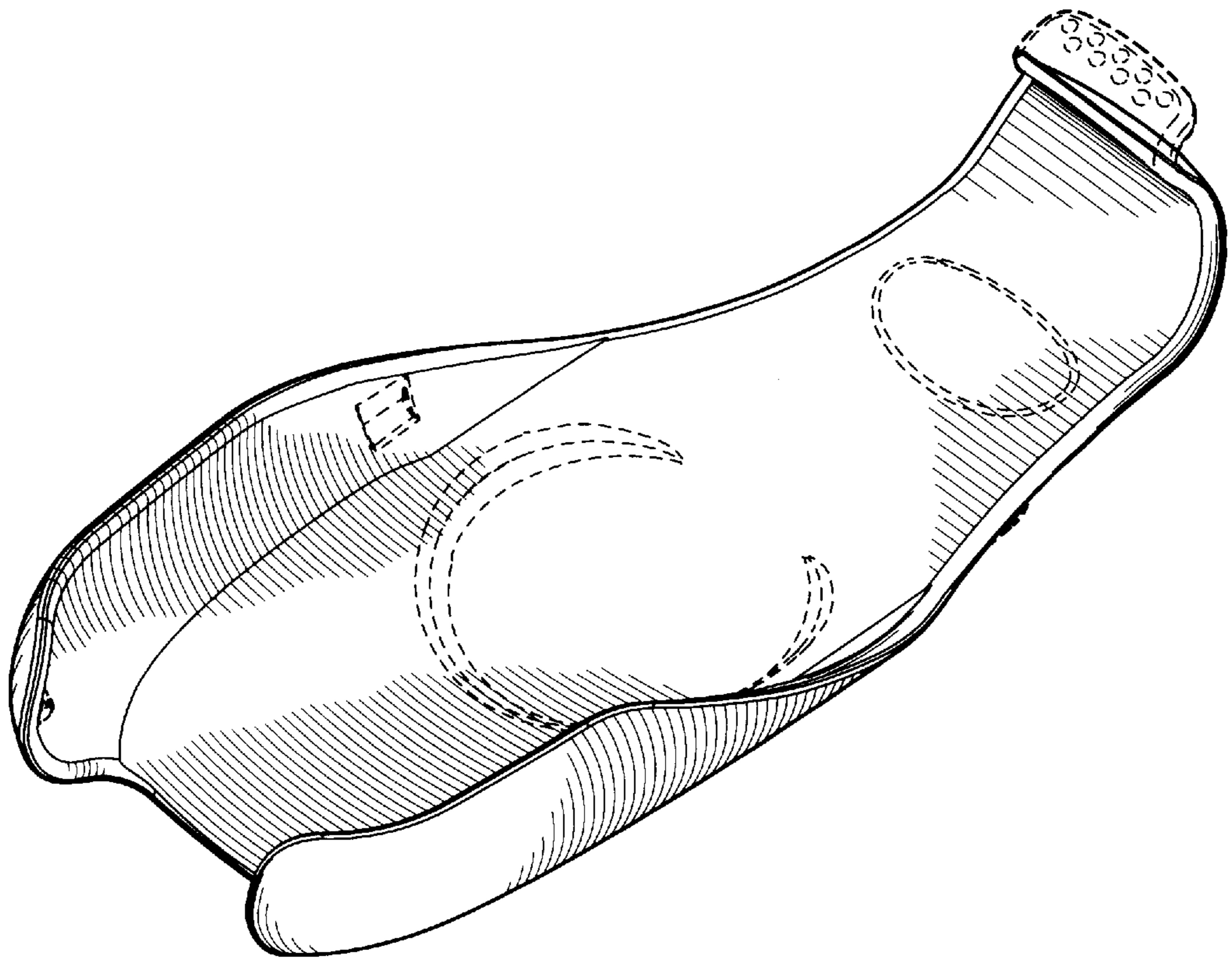

FIG. 1

FIG. 2

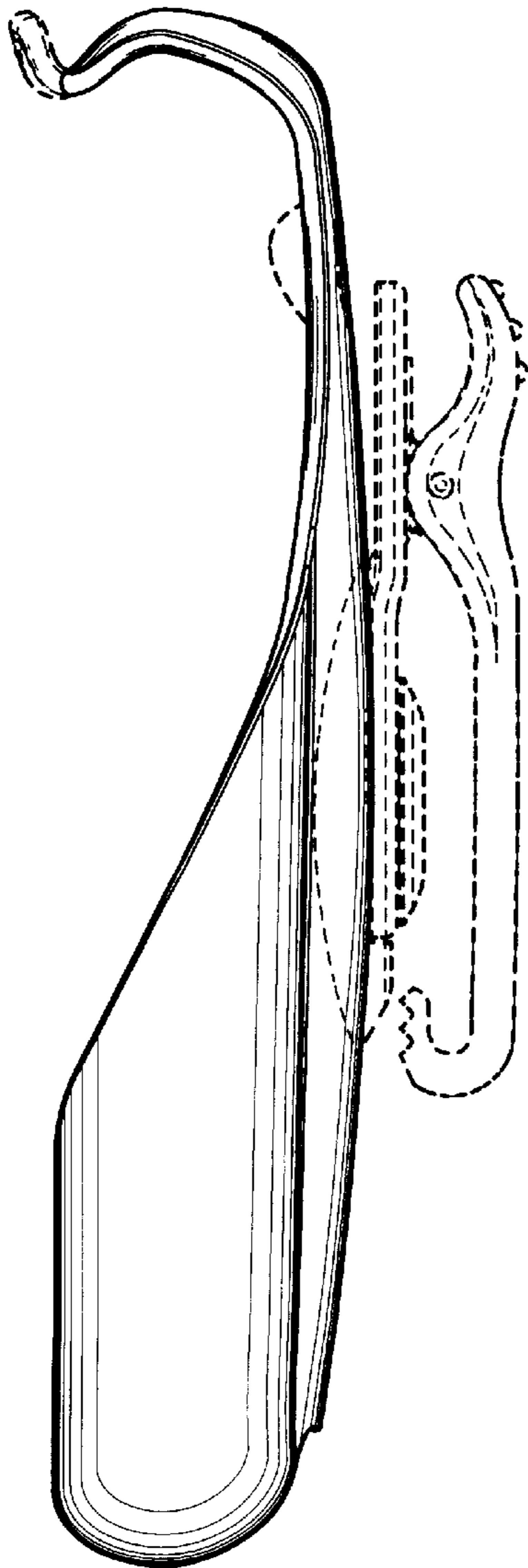
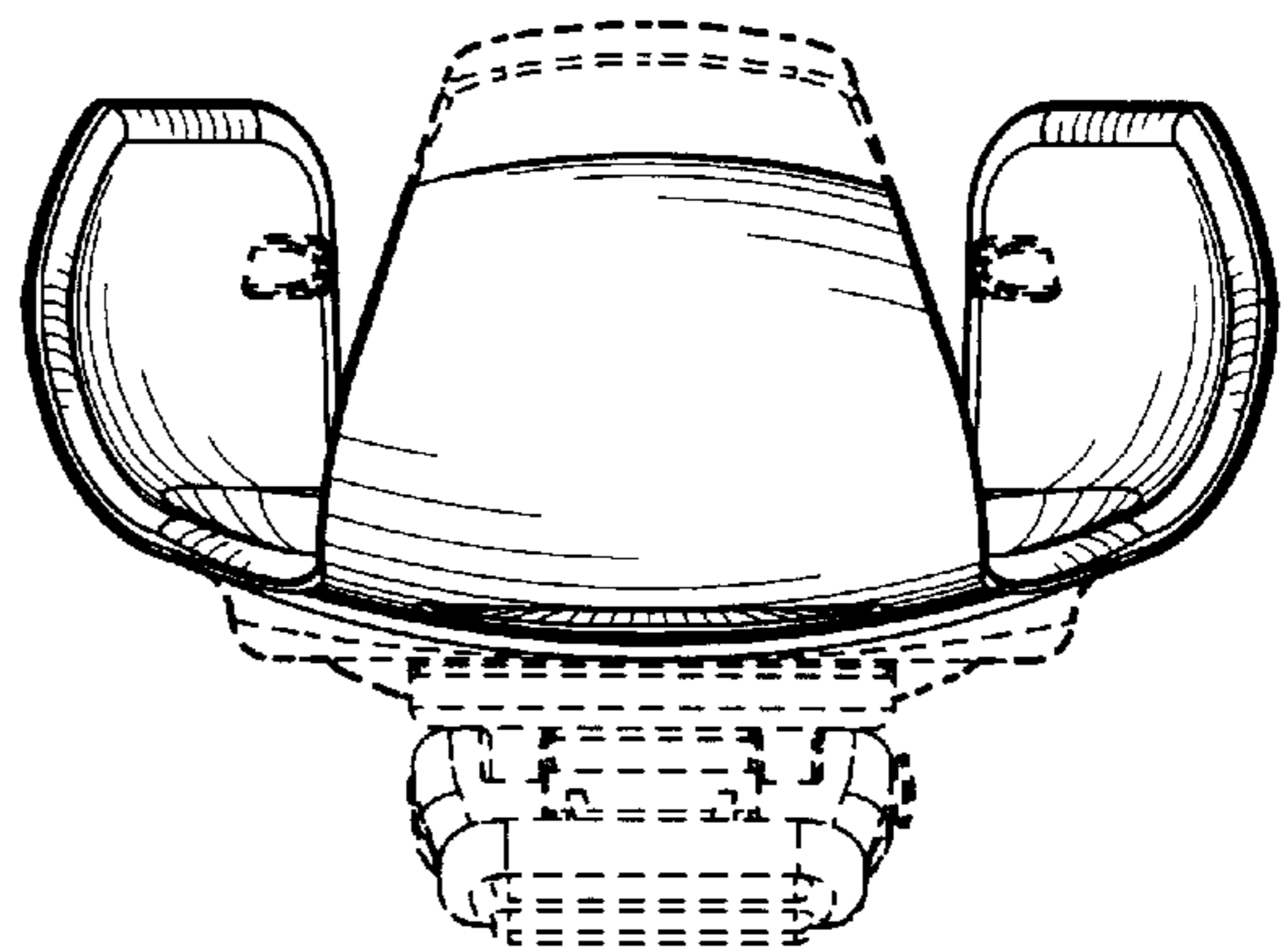

FIG. 3

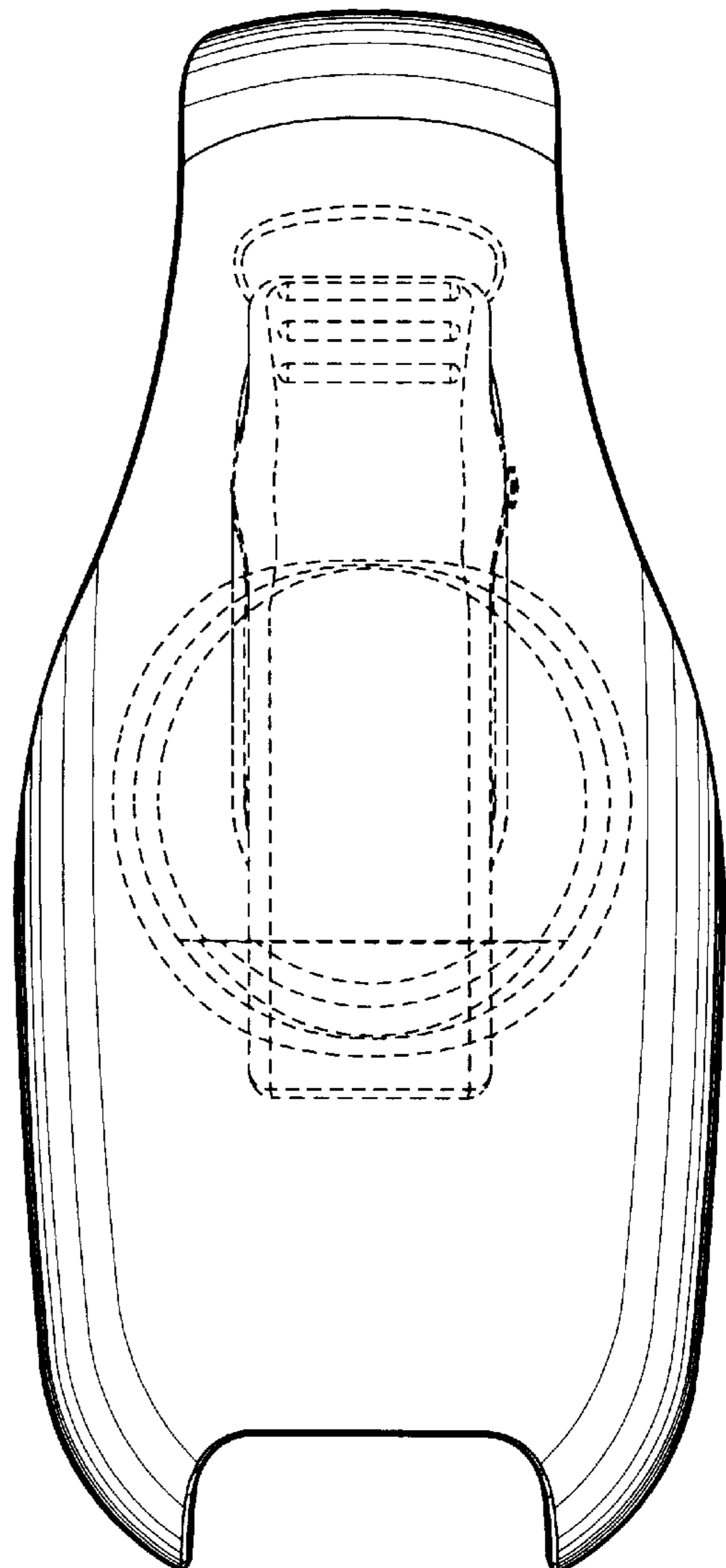

FIG. 4

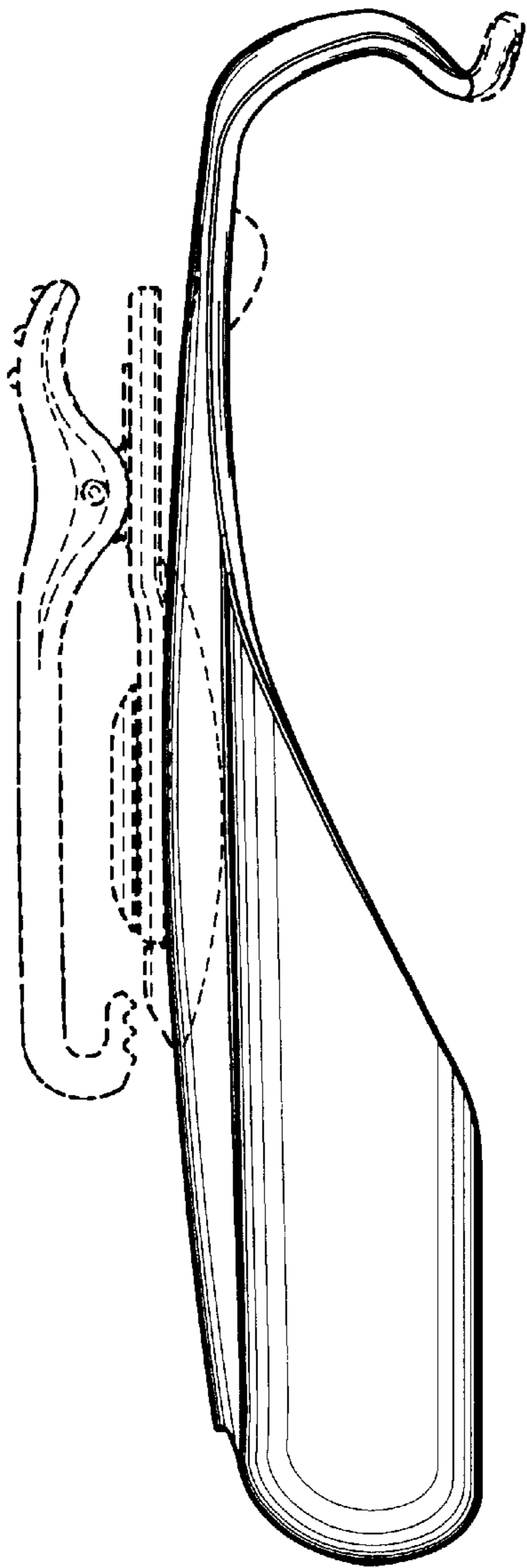

FIG. 5

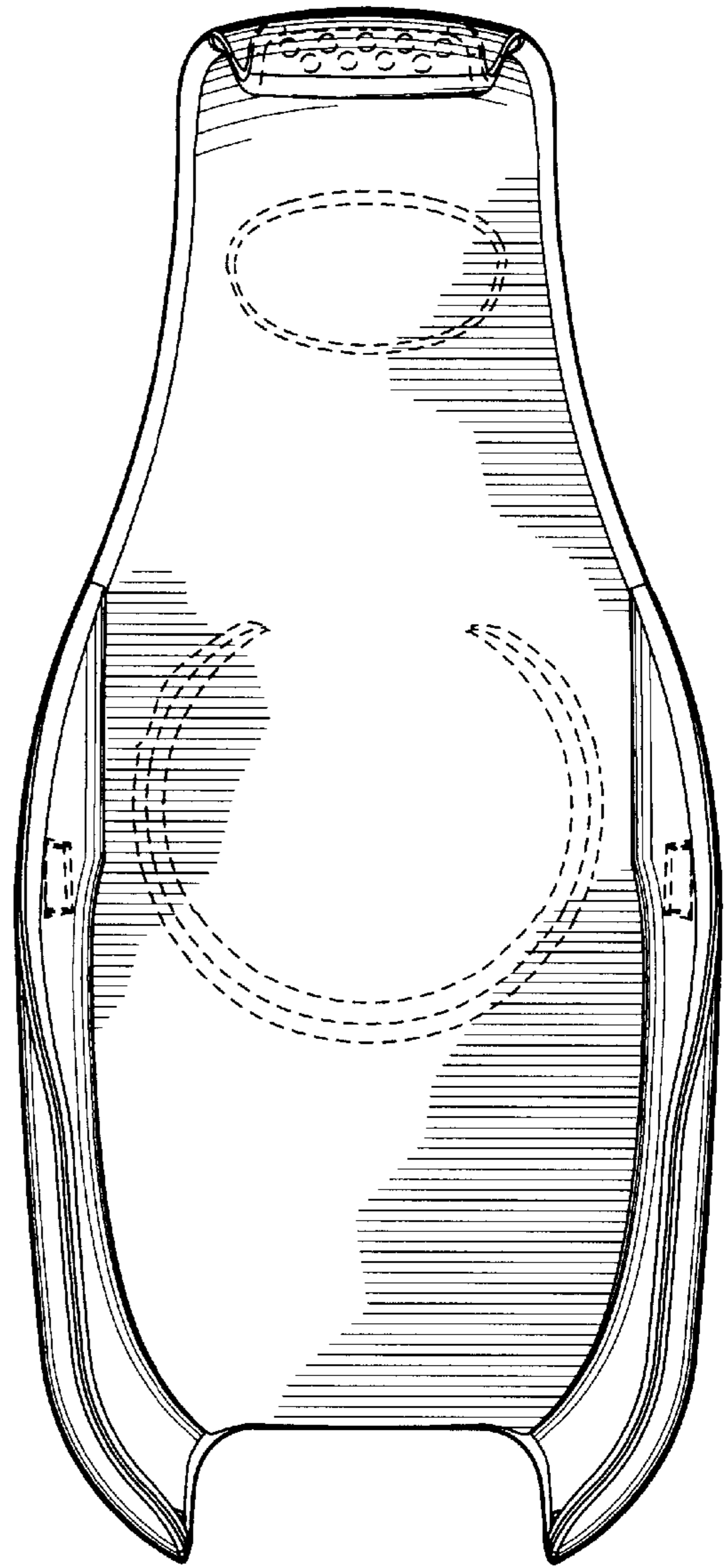
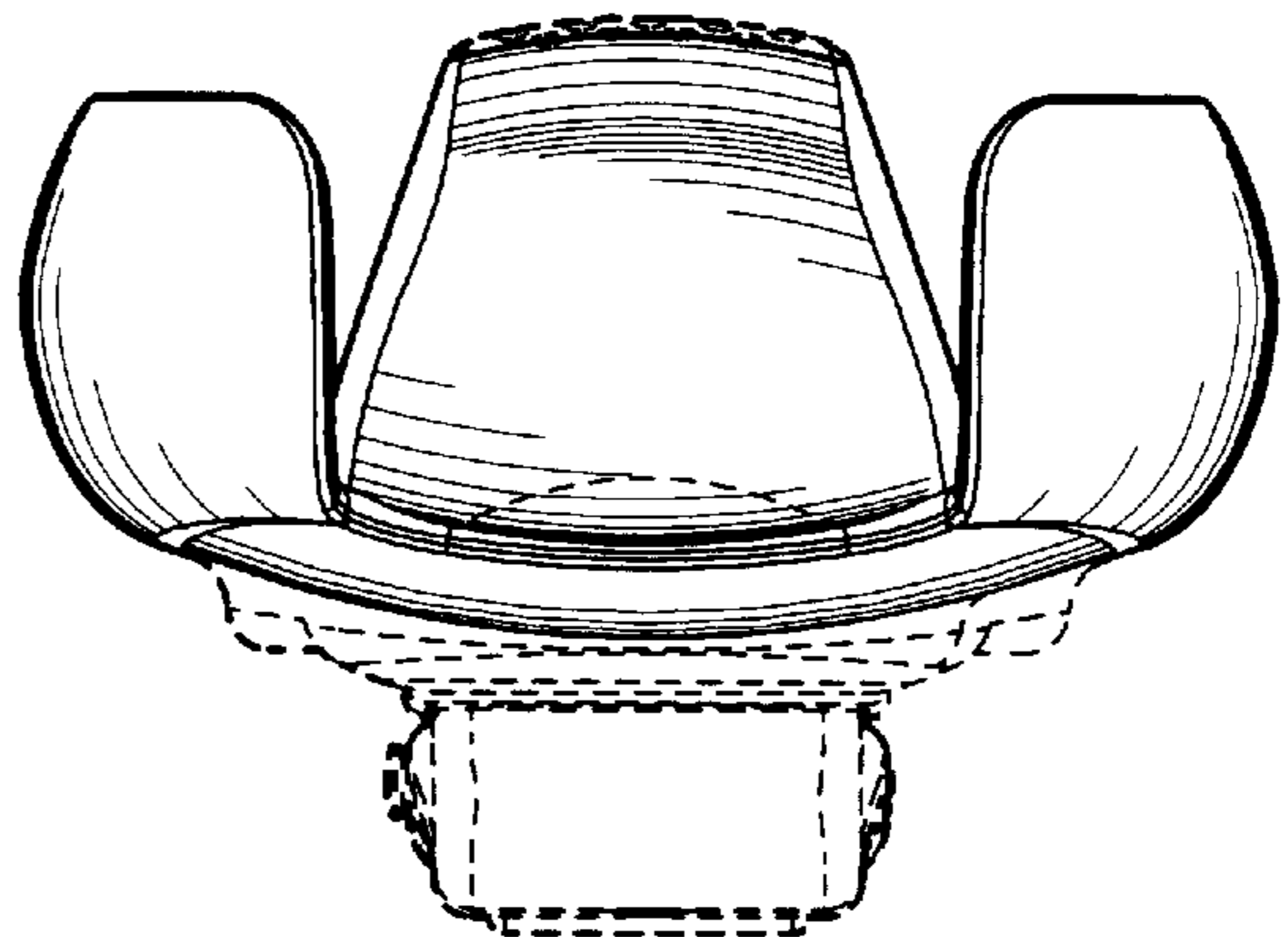

FIG. 6

FIG. 7



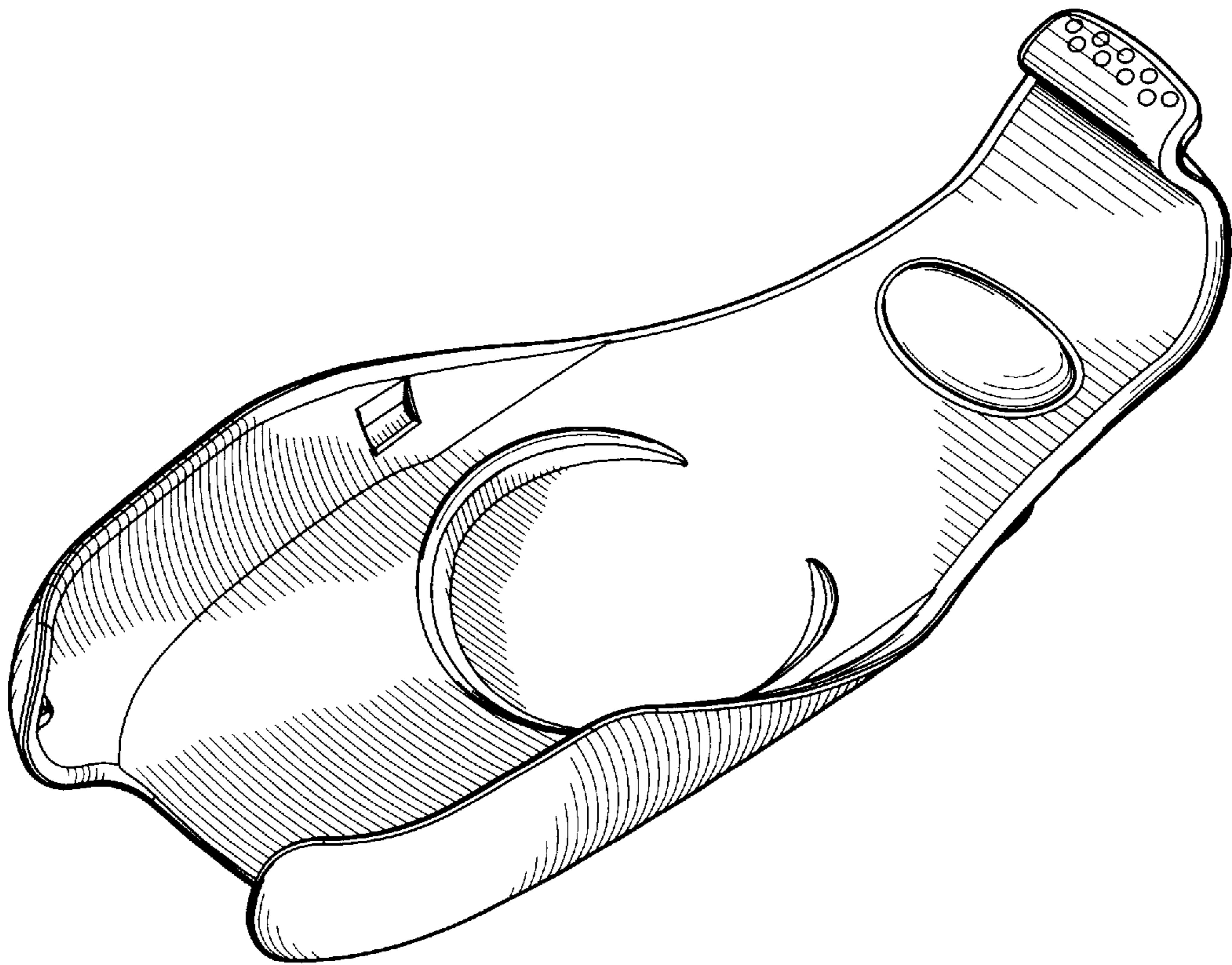

FIG. 8

FIG. 9

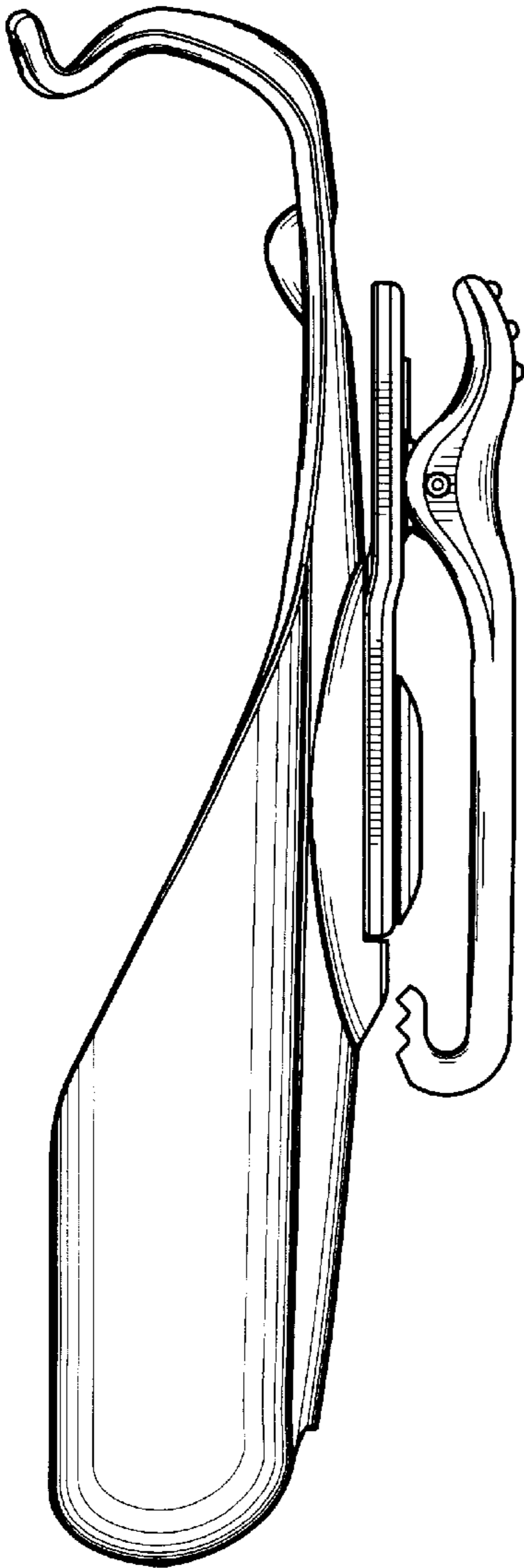
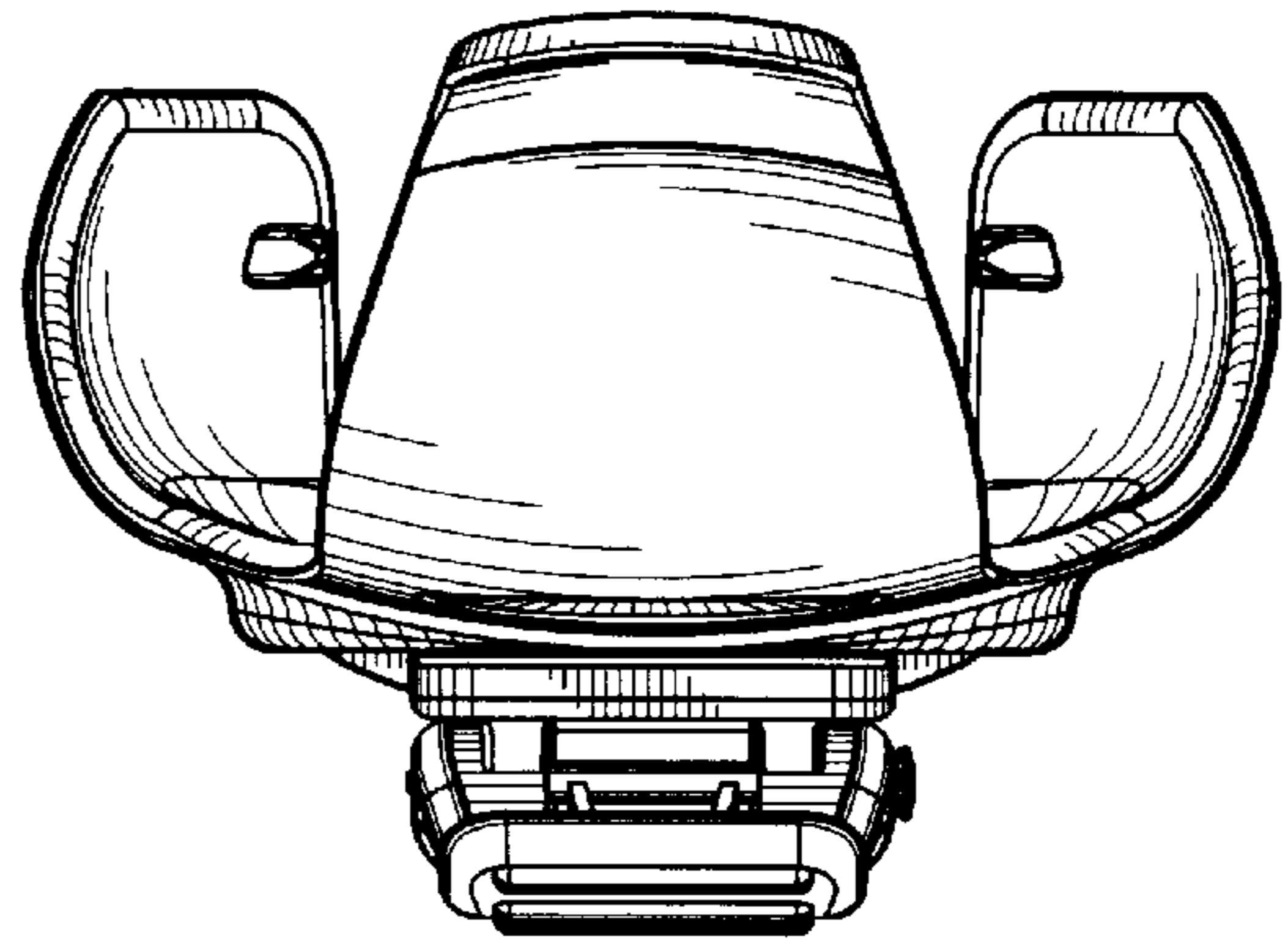

FIG. 10

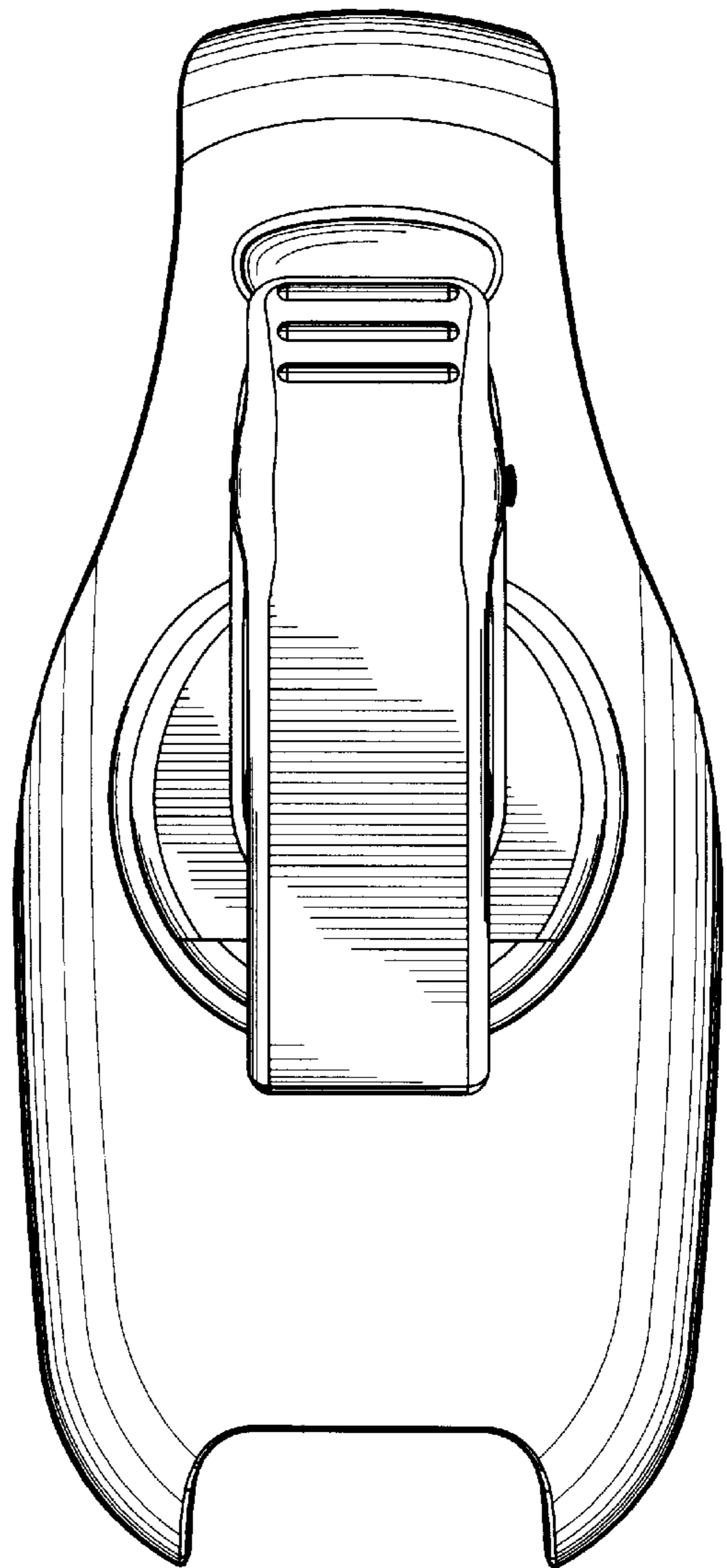

FIG. 11

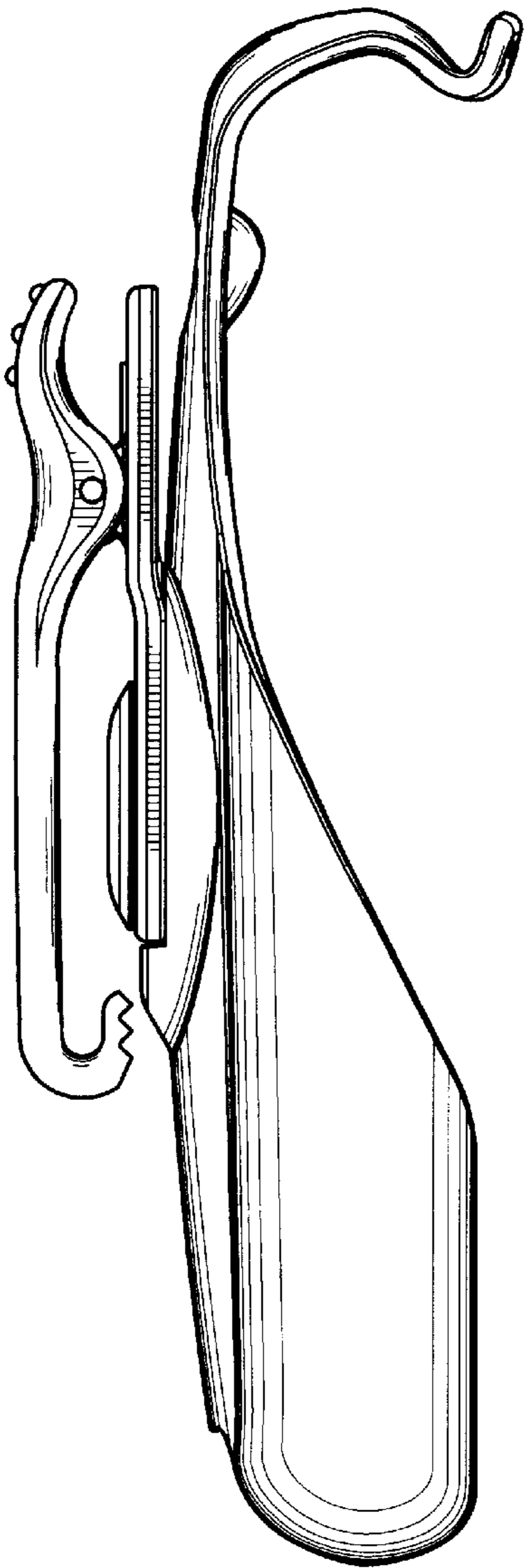

FIG. 12

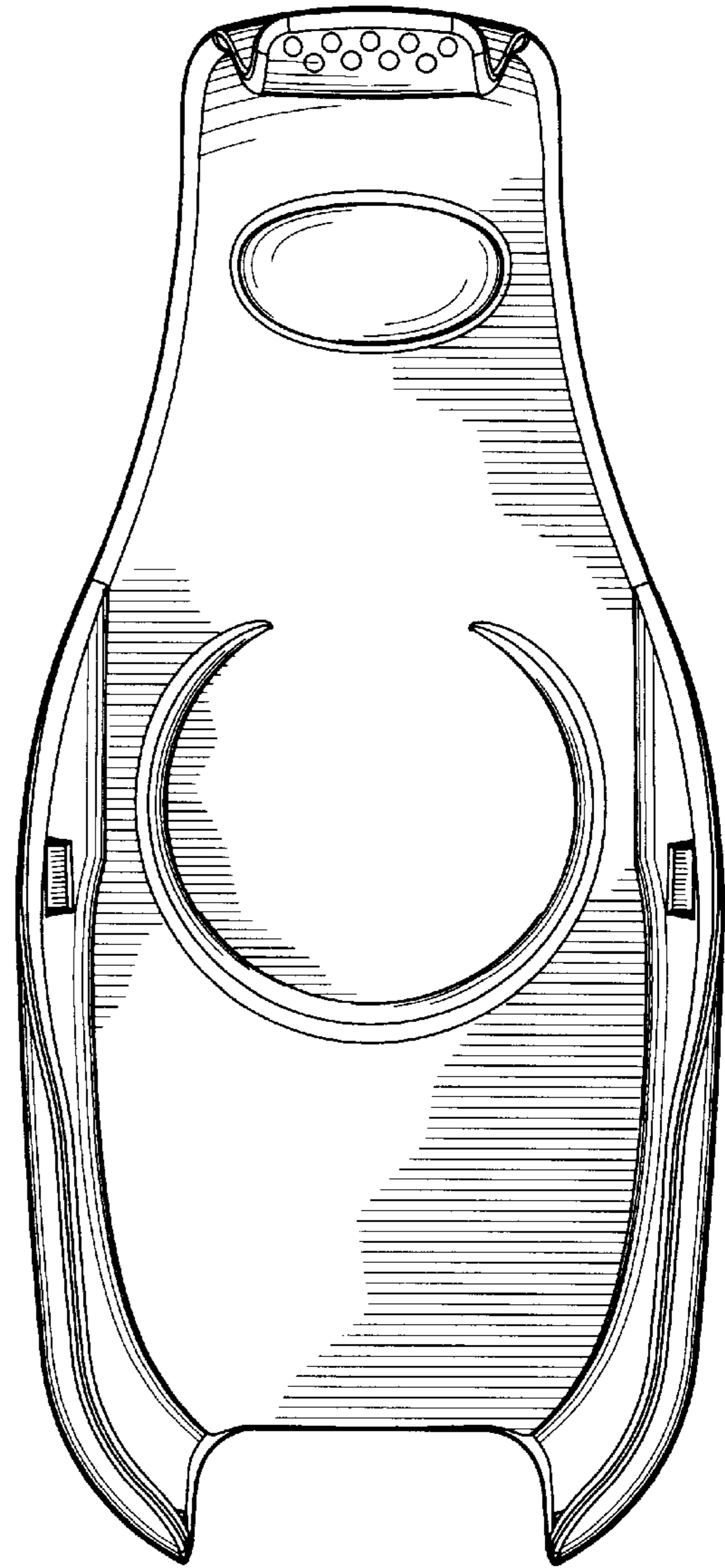

FIG. 13

FIG. 14

