



US00D406162S

# United States Patent [19] Tatsumi

[11] Patent Number: **Des. 406,162**

[45] Date of Patent: **\*\*Feb. 23, 1999**

[54] **TONER BOTTLE**

[75] Inventor: **Kenzo Tatsumi**, Kanagawa, Japan

[73] Assignee: **Ricoh Company, Ltd.**, Tokyo, Japan

[\*\*] Term: **14 Years**

[21] Appl. No.: **66,627**

[22] Filed: **Feb. 21, 1997**

### [30] Foreign Application Priority Data

Aug. 23, 1996 [JP] Japan ..... 8-025239

[51] **LOC (6) Cl.** ..... **16-03**

[52] **U.S. Cl.** ..... **D18/43**

[58] **Field of Search** ..... D18/40, 43, 56;  
399/24, 27, 28, 35, 61, 99, 106, 120, 224,  
262; 222/DIG. 1

### [56] References Cited

#### U.S. PATENT DOCUMENTS

- D. 298,331 11/1988 Takahashi et al. .... D18/43
- D. 351,187 10/1994 Suga ..... D18/40 X
- D. 356,813 3/1995 Ichikawa et al. .... D18/43
- D. 362,678 9/1995 Ishibashi et al. .... D18/43
- D. 364,418 11/1995 Hagiwara et al. .... D18/43
- D. 365,359 12/1995 Ichikawa et al. .... D18/43

- D. 374,456 10/1996 Wakatsuki et al. .... D18/43
- D. 375,519 11/1996 Tsumuki ..... D18/43
- D. 376,614 12/1996 Ichikawa et al. .... D18/43
- D. 389,176 1/1998 Ichikawa et al. .... D18/43
- 5,455,662 10/1995 Ichikawa et al. .... 399/260
- 5,528,349 6/1996 Satake ..... 399/262
- 5,557,381 9/1996 Sakamoto et al. .... 399/262 X
- 5,557,382 9/1996 Tatsumi et al. .... 399/262
- 5,589,919 12/1996 Ikunami et al. .... 399/262
- 5,648,840 7/1997 Ikunami et al. .... 399/262

*Primary Examiner*—Caron D. Veynar  
*Attorney, Agent, or Firm*—Dickstein Shapiro Morin & Oshinsky LLP

### [57] CLAIM

The ornamental design for toner bottle, as shown and described.

### DESCRIPTION

FIG. 1 is a top, front, and left side perspective view of a tonner bottle showing my new design;  
FIG. 2 is a front elevation thereof;  
FIG. 3 is a rear elevation thereof;  
FIG. 4 is a top plan view thereof;  
FIG. 5 is a bottom plan view thereof;  
FIG. 6 is a left side elevation thereof; and,  
FIG. 7 is a right side elevation thereof.

**1 Claim, 3 Drawing Sheets**

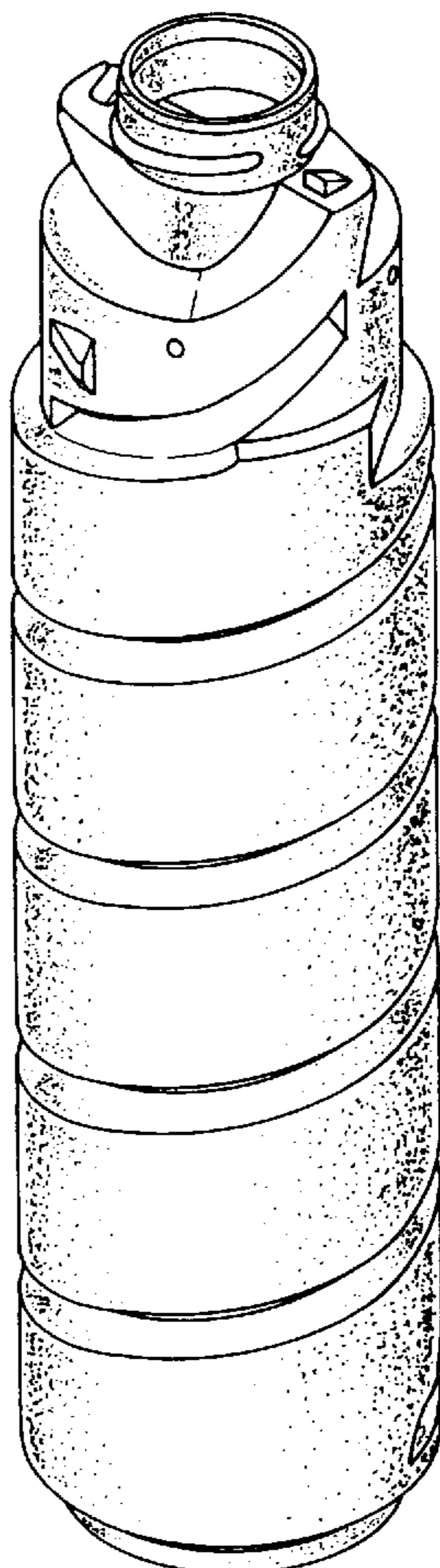

FIG. 1

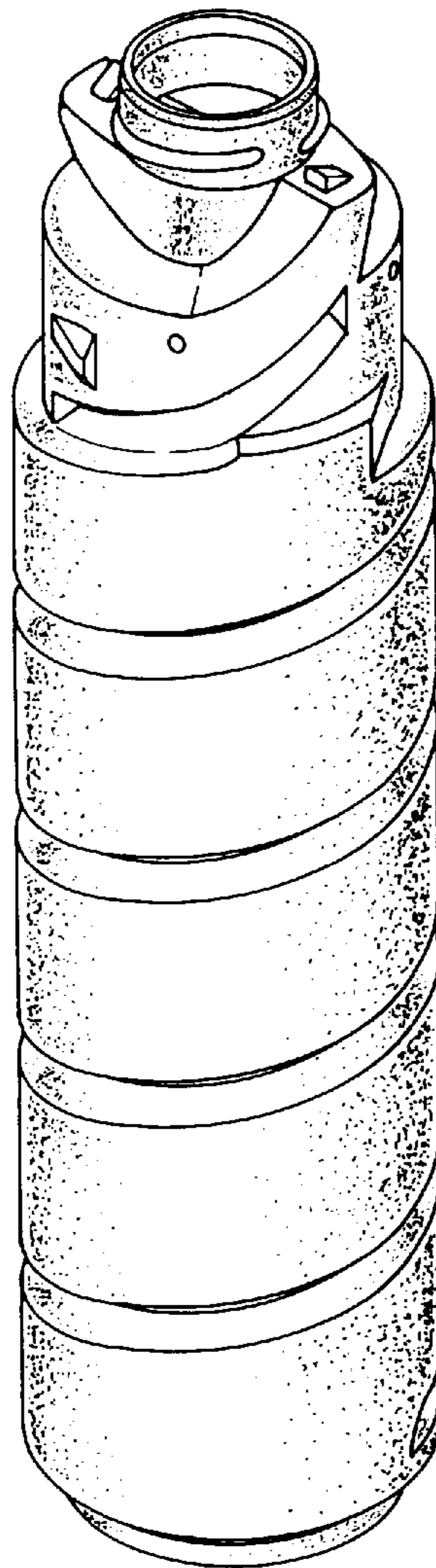

FIG. 2

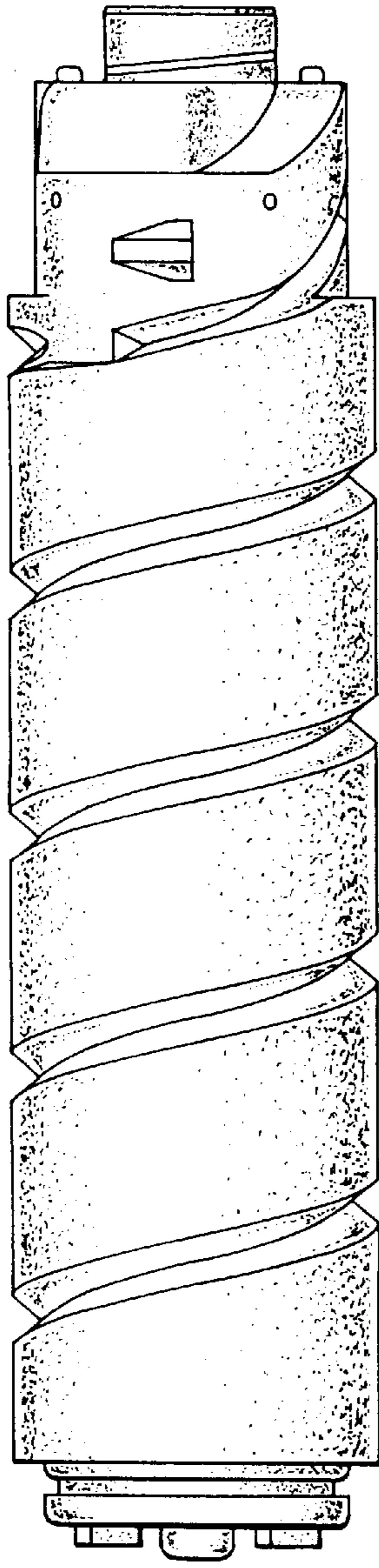

FIG. 3

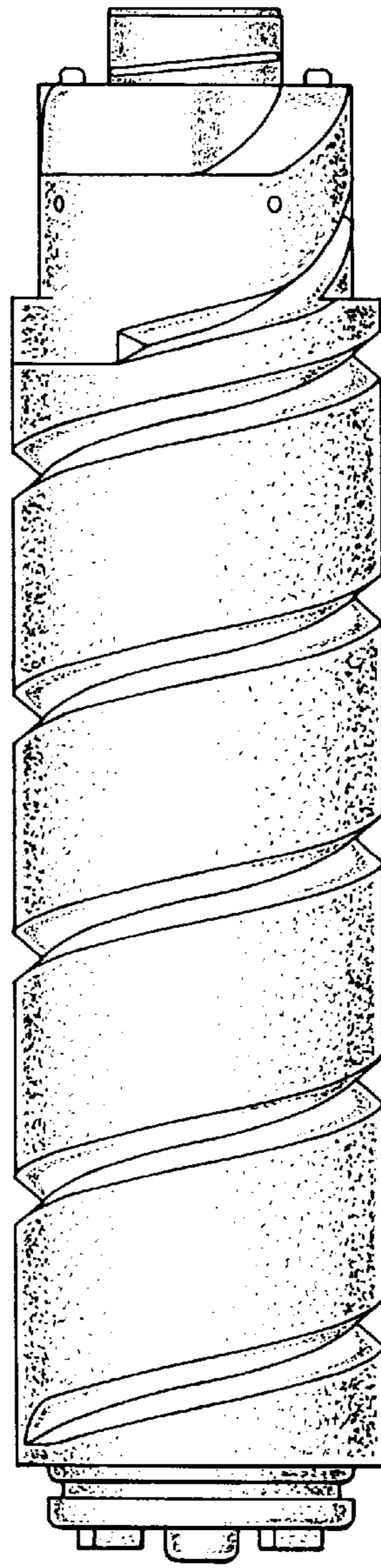

FIG. 4

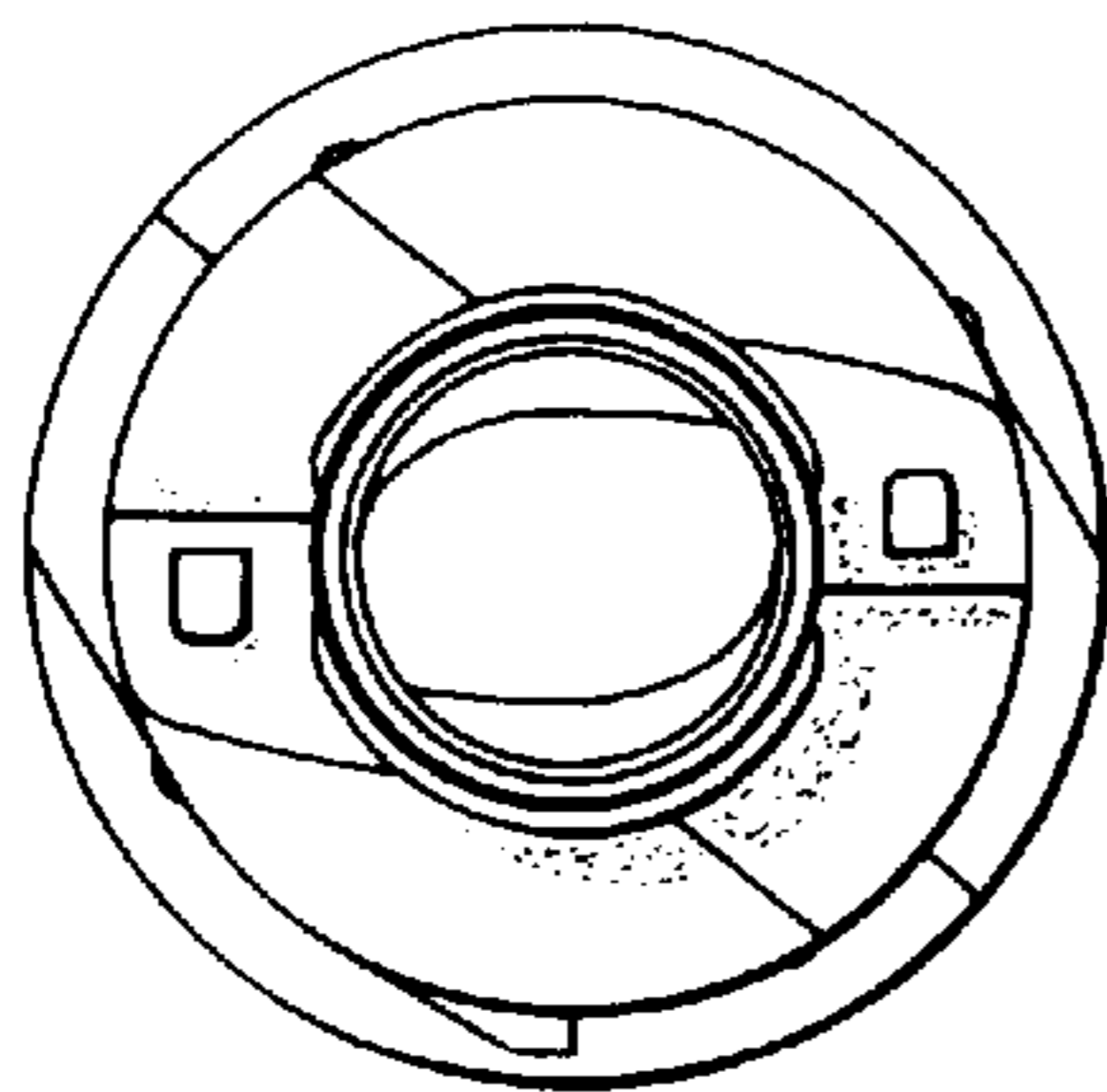

FIG. 5

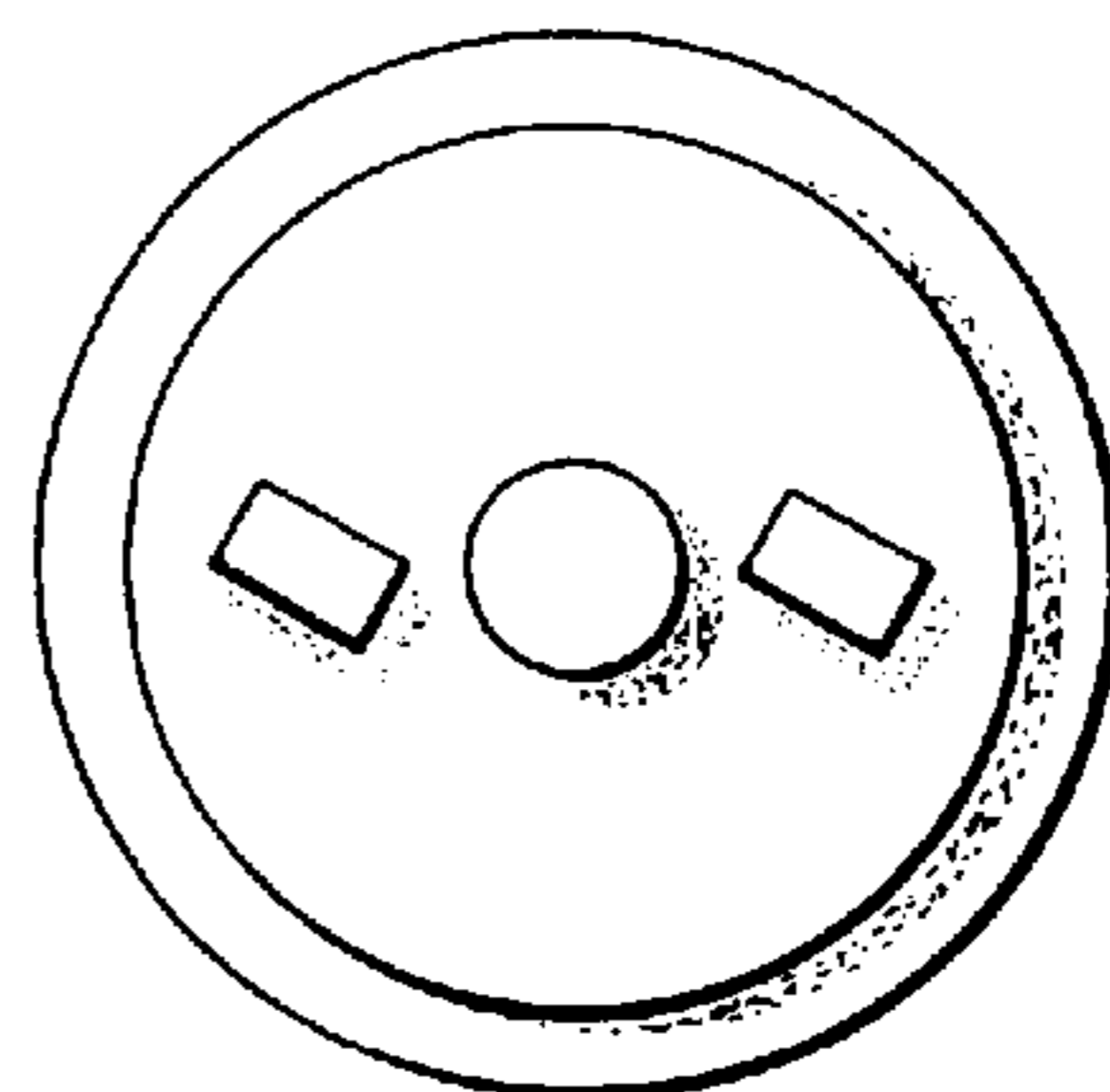

FIG. 6

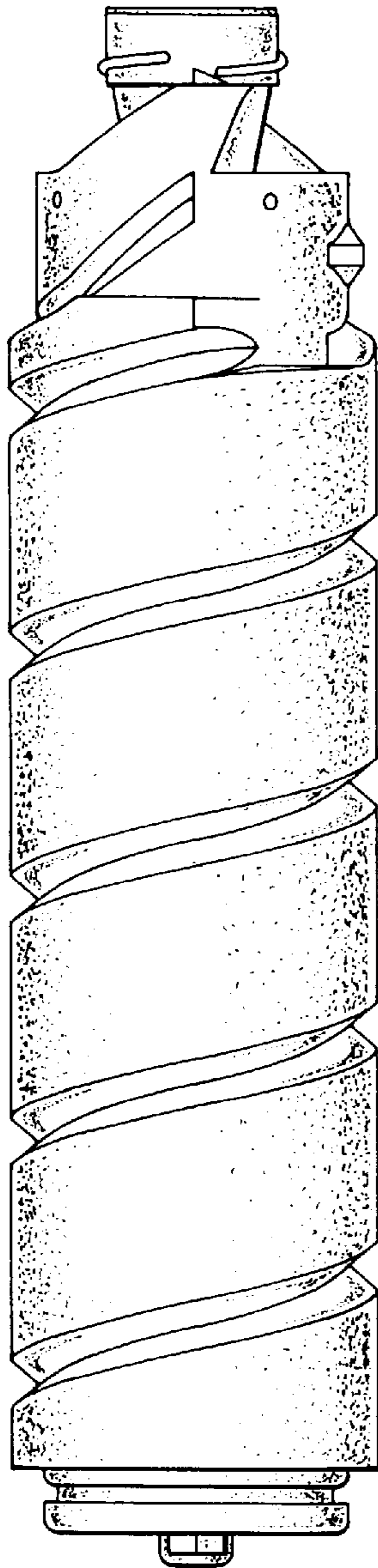

FIG. 7

