



US00D406098S

# United States Patent [19]

Walter et al.

[11] Patent Number: **Des. 406,098**

[45] Date of Patent: **\*\*Feb. 23, 1999**

[54] BATTERY HOUSING

[75] Inventors: **Jeffrey A. Walter**, Huntley, Ill.; **Aaron P. Clark**, Buford, Ga.; **Bradley K. Lohrding**, Gurnee, Ill.

[73] Assignee: **Motorola, Inc.**, Schaumburg, Ill.

[\*\*] Term: **14 Years**

[21] Appl. No.: **88,190**

[22] Filed: **May 18, 1998**

[51] LOC (6) Cl. .... **13-02**

[52] U.S. Cl. .... **D13/103**

[58] Field of Search ..... D13/103; 429/96-100, 429/163, 176

[56] **References Cited**

**U.S. PATENT DOCUMENTS**

D. 12,444	8/1881	Simpson .	
D. 280,717	9/1985	Scheid et al. .	
D. 302,005	7/1989	Kizawa et al. .	
D. 304,439	11/1989	Mitchell et al. .	
D. 305,717	1/1990	Soren et al. .	
D. 349,882	8/1994	Johnson .....	D13/103
D. 354,040	1/1995	Siddoway et al. ....	D13/103
D. 358,127	5/1995	Berry .....	D13/103
D. 367,640	3/1996	Nagele et al. ....	D13/103
D. 375,932	11/1996	Nagele et al. ....	D13/103
D. 385,742	11/1997	Amero, Jr. et al. ....	D13/103
4,085,253	4/1978	Johnson .....	429/1
4,653,822	3/1987	Kanazawa .....	339/17
4,666,799	5/1987	Runquist et al. ....	429/101

4,912,602	3/1990	Zurek et al. ....	361/399
5,102,753	4/1992	Rossoll et al. ....	429/192
5,625,271	4/1997	Shapiro et al. ....	429/97 X
5,631,101	5/1997	Amero, Jr. ....	429/97 X

*Primary Examiner*—Joel Sincavage  
*Attorney, Agent, or Firm*—John G. Rauch

[57] **CLAIM**

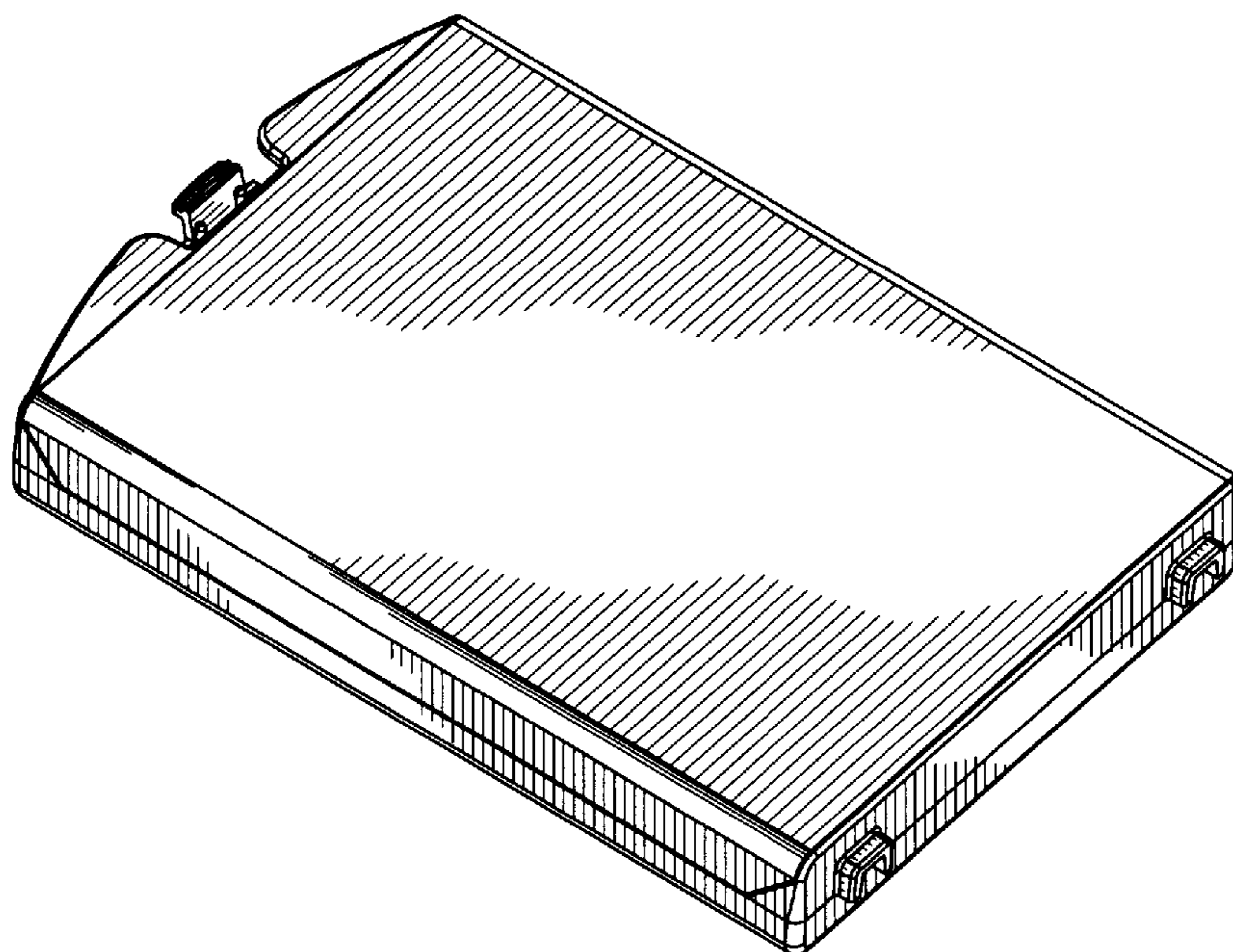
The ornamental design for a battery housing, as shown and described.

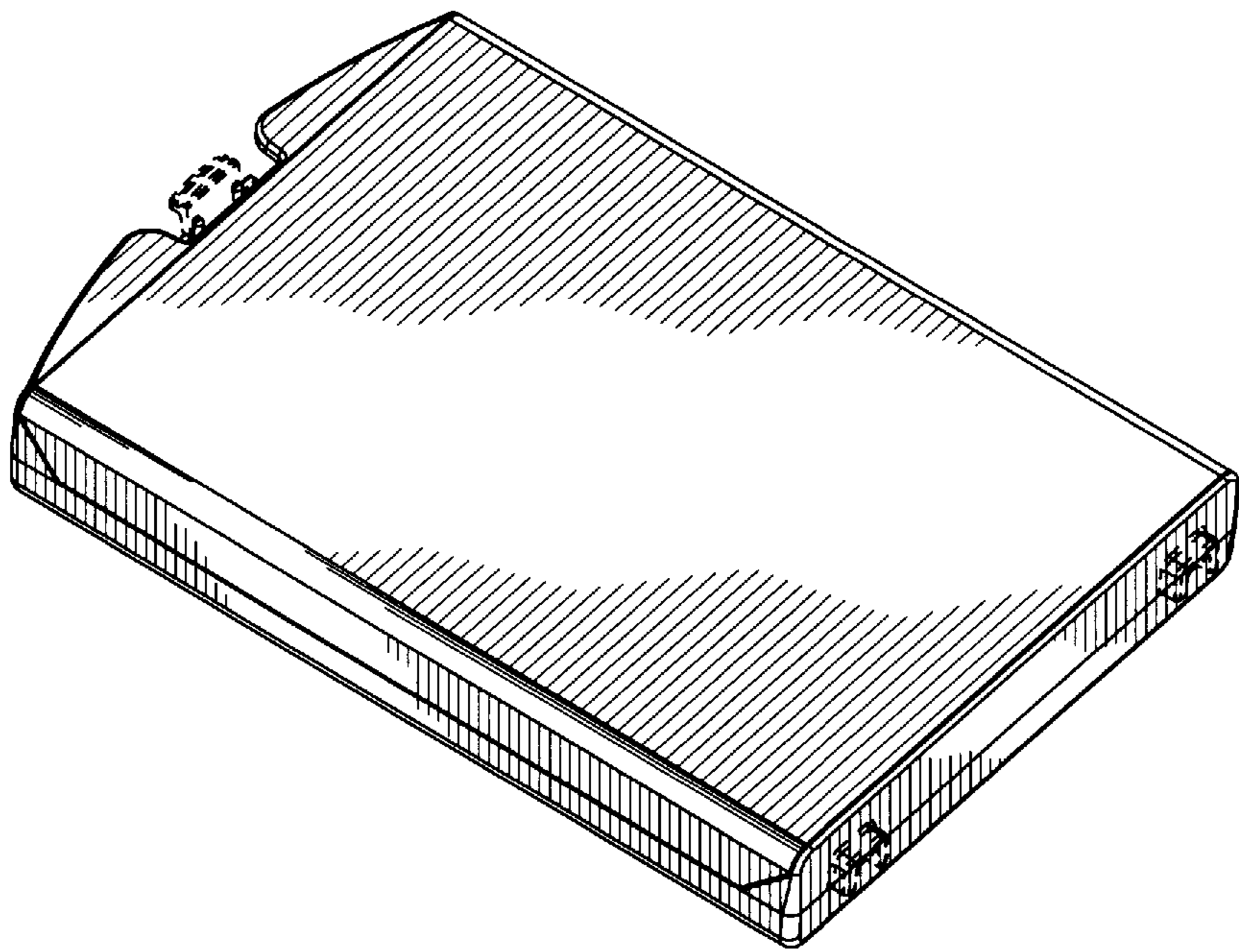
**DESCRIPTION**

FIG. 1 is a right, front, bottom view of first embodiment of a battery housing, showing our new design; FIG. 2 is a front elevation view thereof; FIG. 3 is a left side elevation view thereof; FIG. 4 is a bottom elevation view thereof; FIG. 5 is a top elevation view thereof; FIG. 6 is a rear elevation view thereof; and, FIG. 7 is a right side elevation view thereof; FIG. 8 is a right, front, bottom view of second embodiment of a battery housing, showing our new design; FIG. 9 is a front elevation view thereof; FIG. 10 is a left side elevation view thereof; FIG. 11 is a bottom elevation view thereof; FIG. 12 is a top elevation view thereof; FIG. 13 is a rear elevation view thereof; and, FIG. 14 is a right side elevation view thereof.

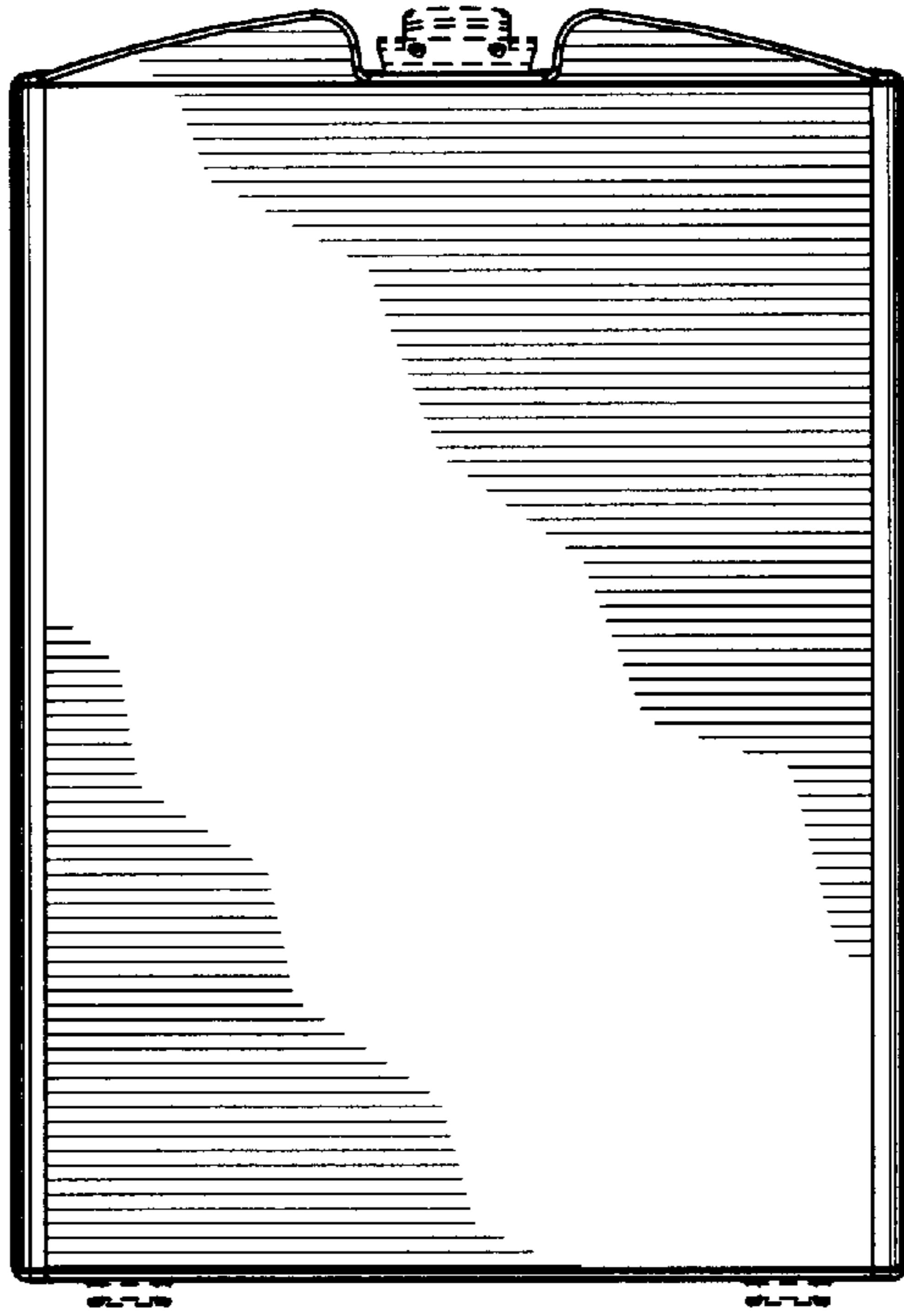
The broken line matter in FIGS. 1-7 is included for the purpose of illustrating environmental structure only and forms no part of the first embodiment.

**1 Claim, 6 Drawing Sheets**

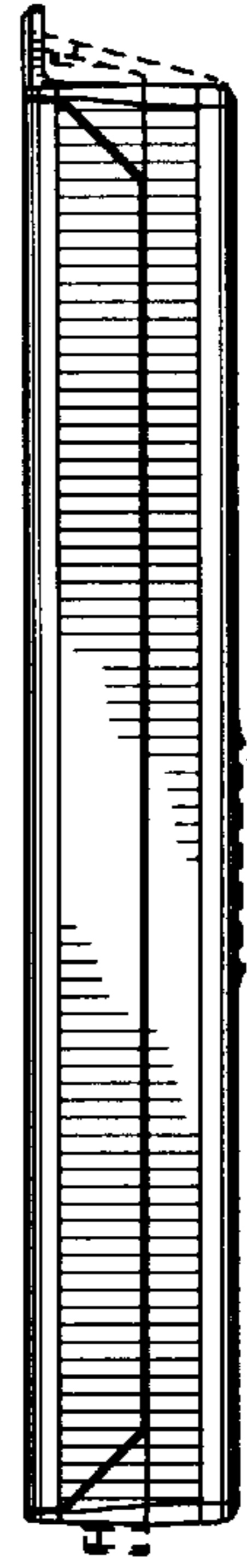




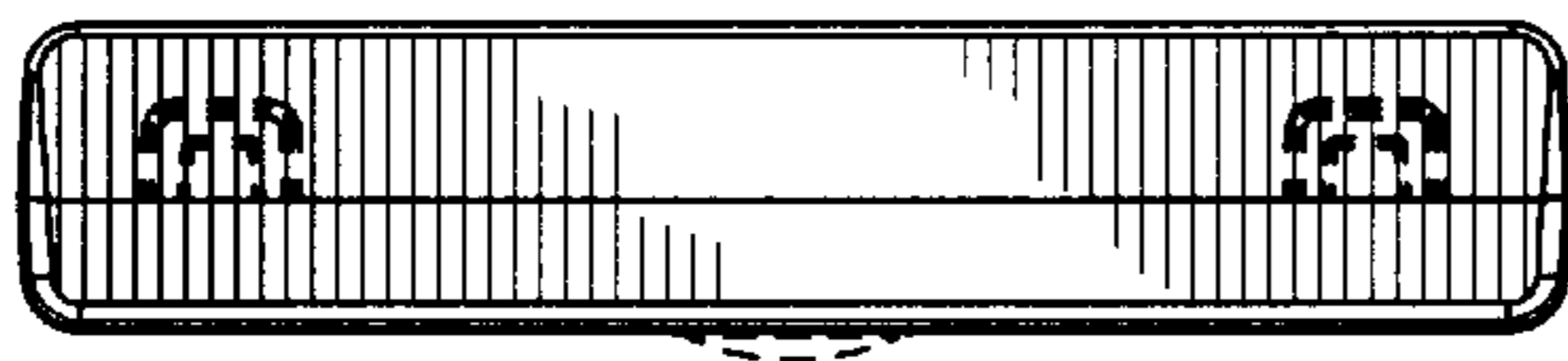
*FIG. 1*



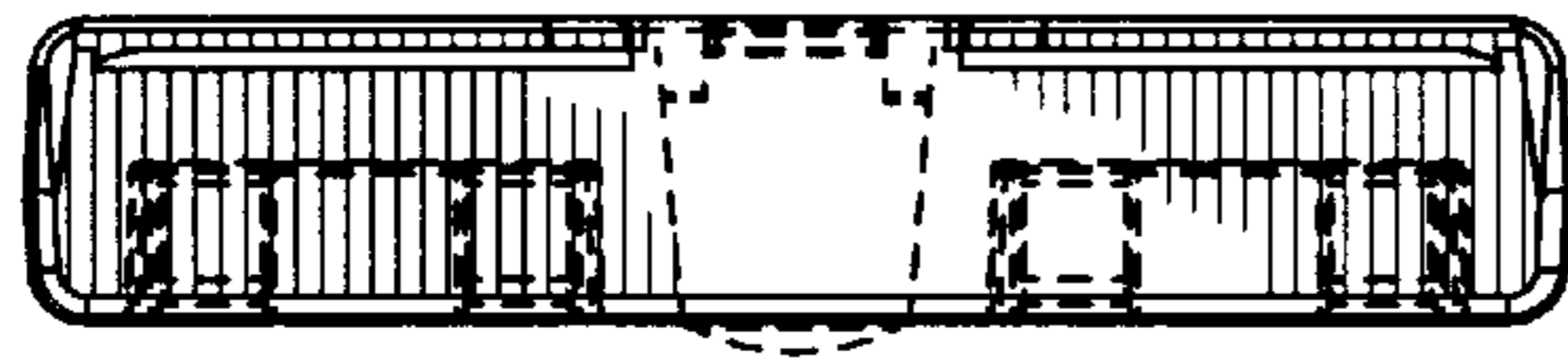
*FIG. 2*



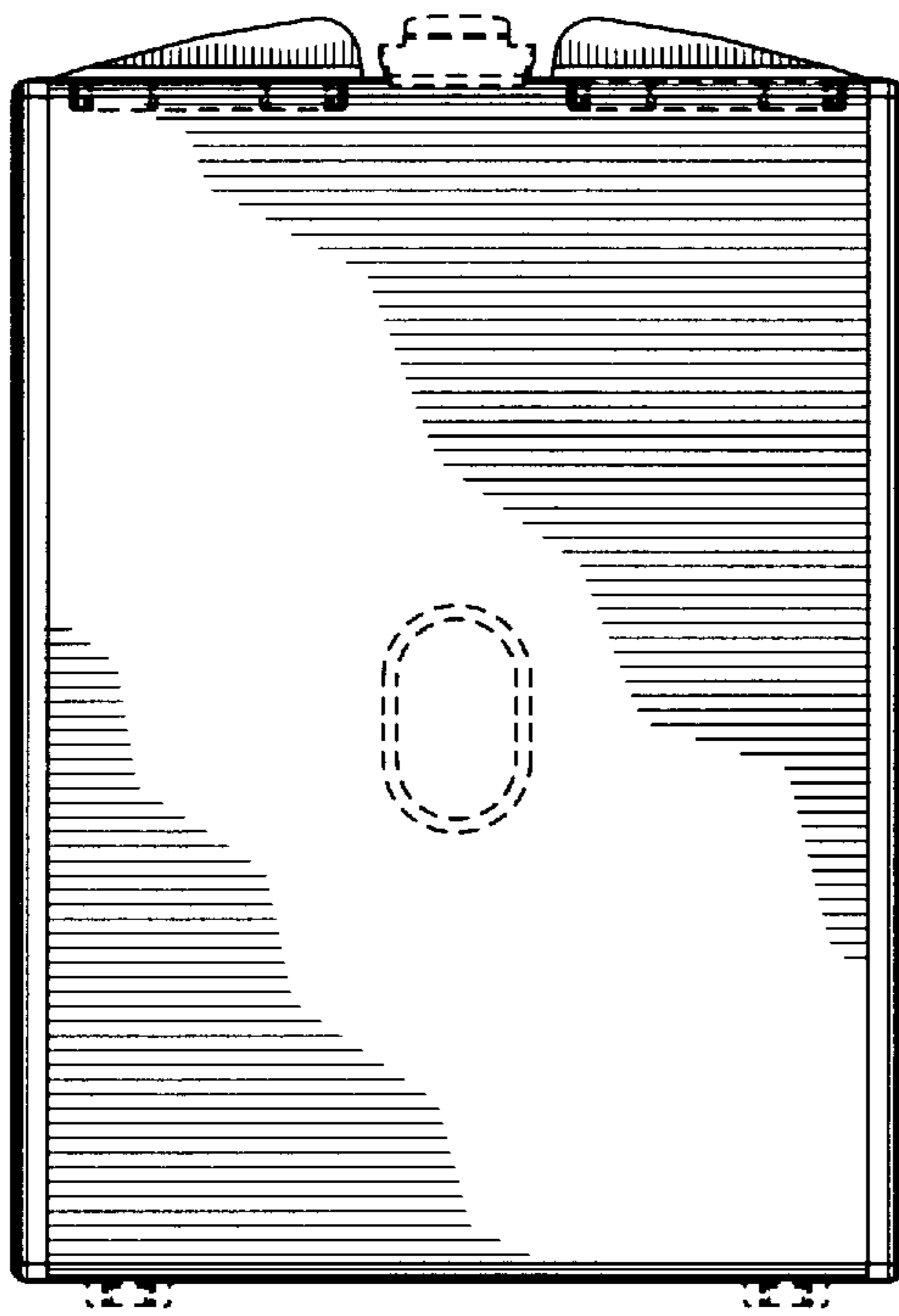
*FIG. 3*



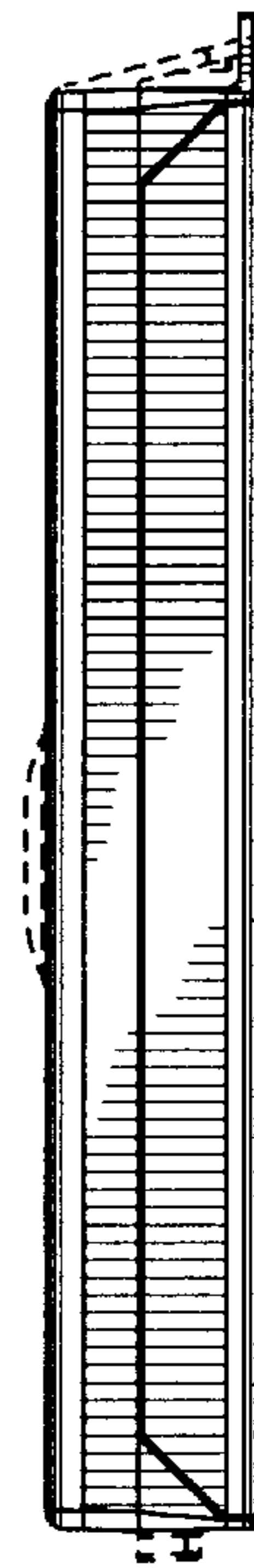
*FIG. 4*



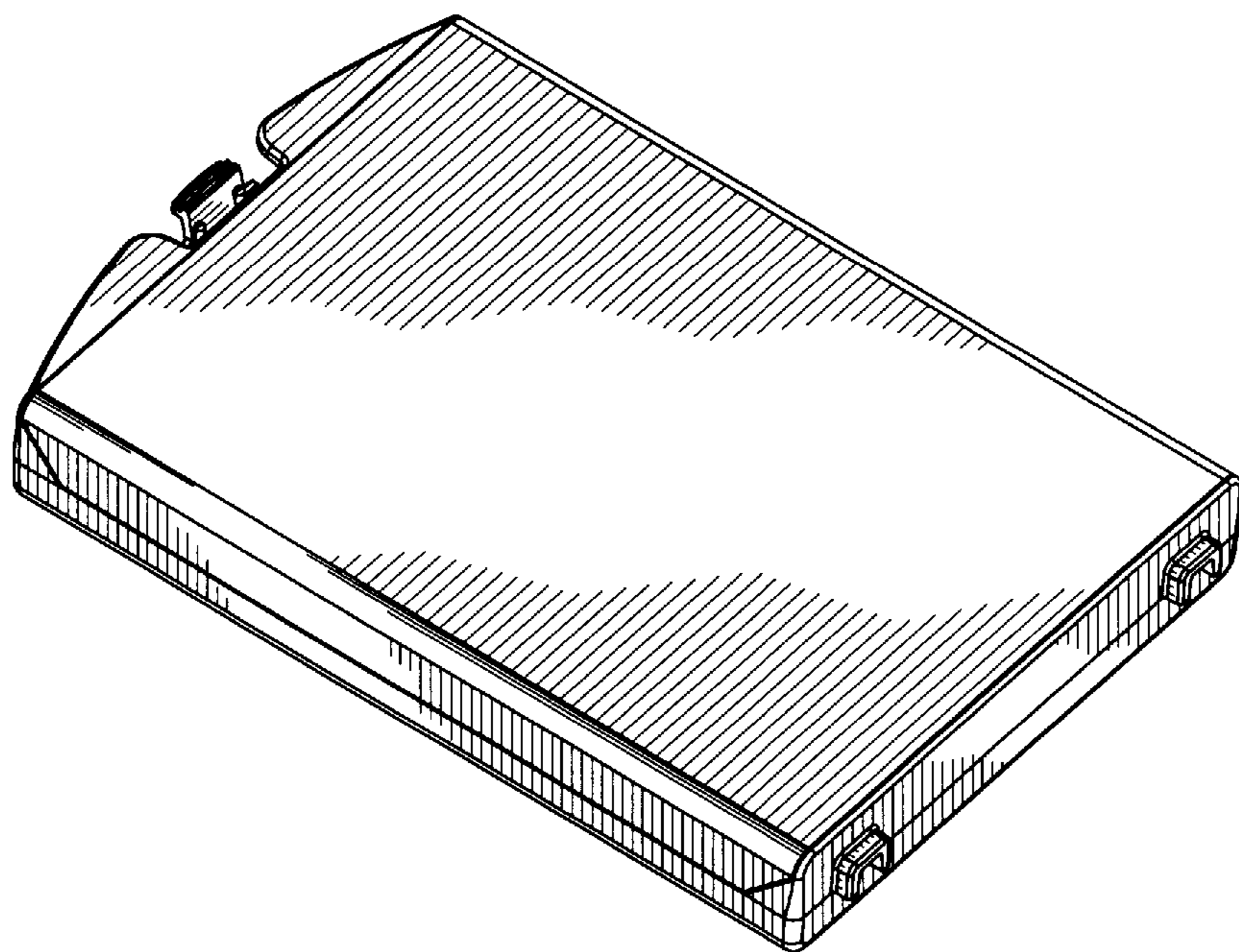
*FIG. 5*



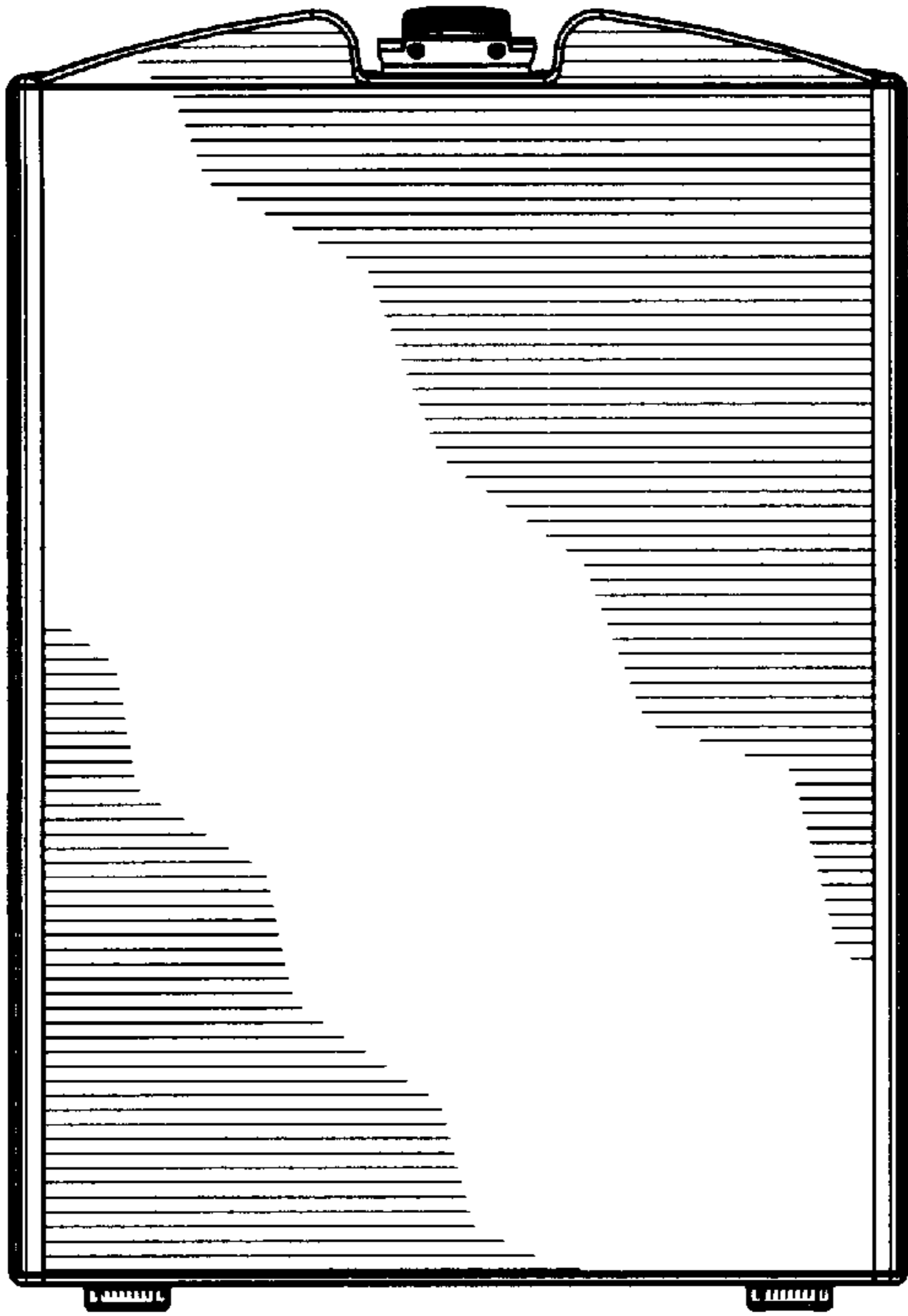
*FIG. 6*



*FIG. 7*



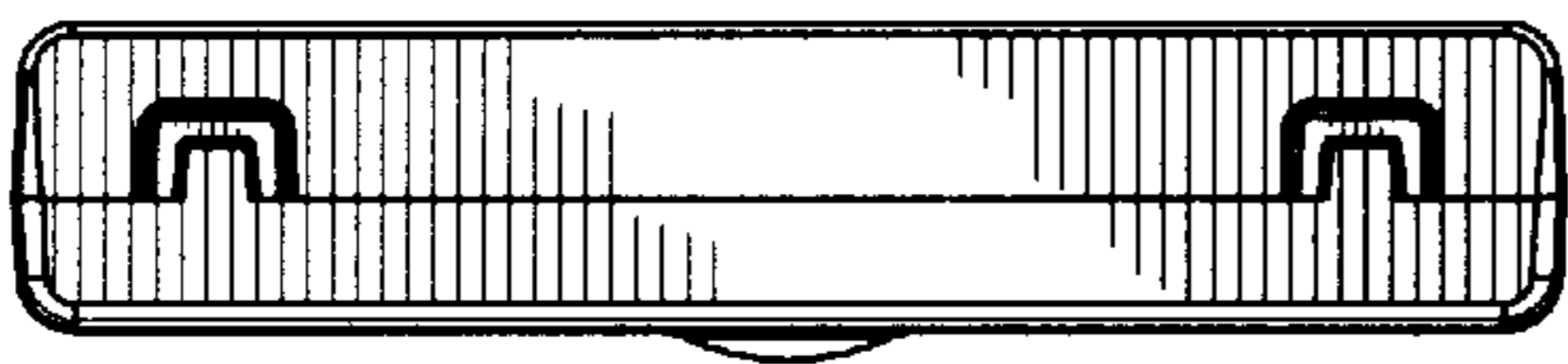
*FIG. 8*



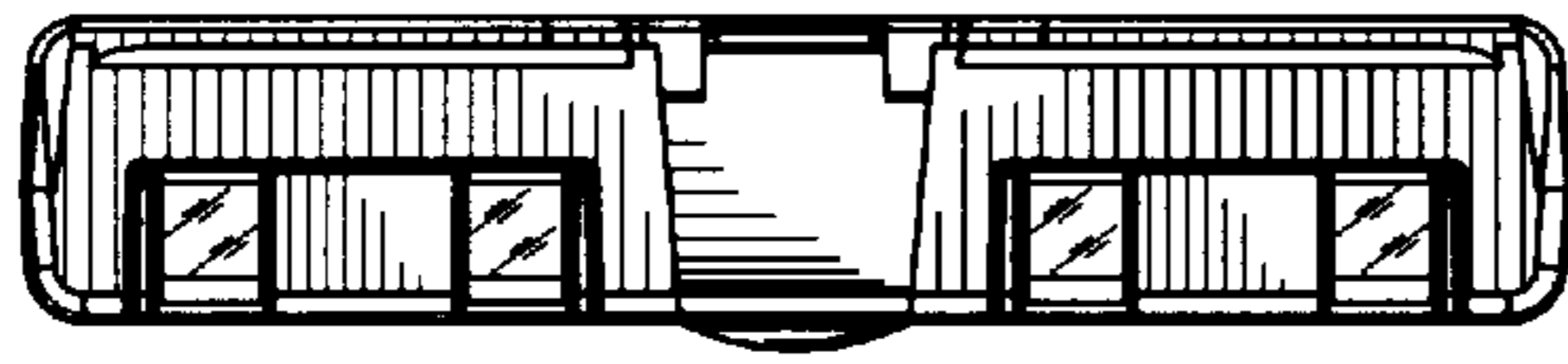
*FIG. 9*



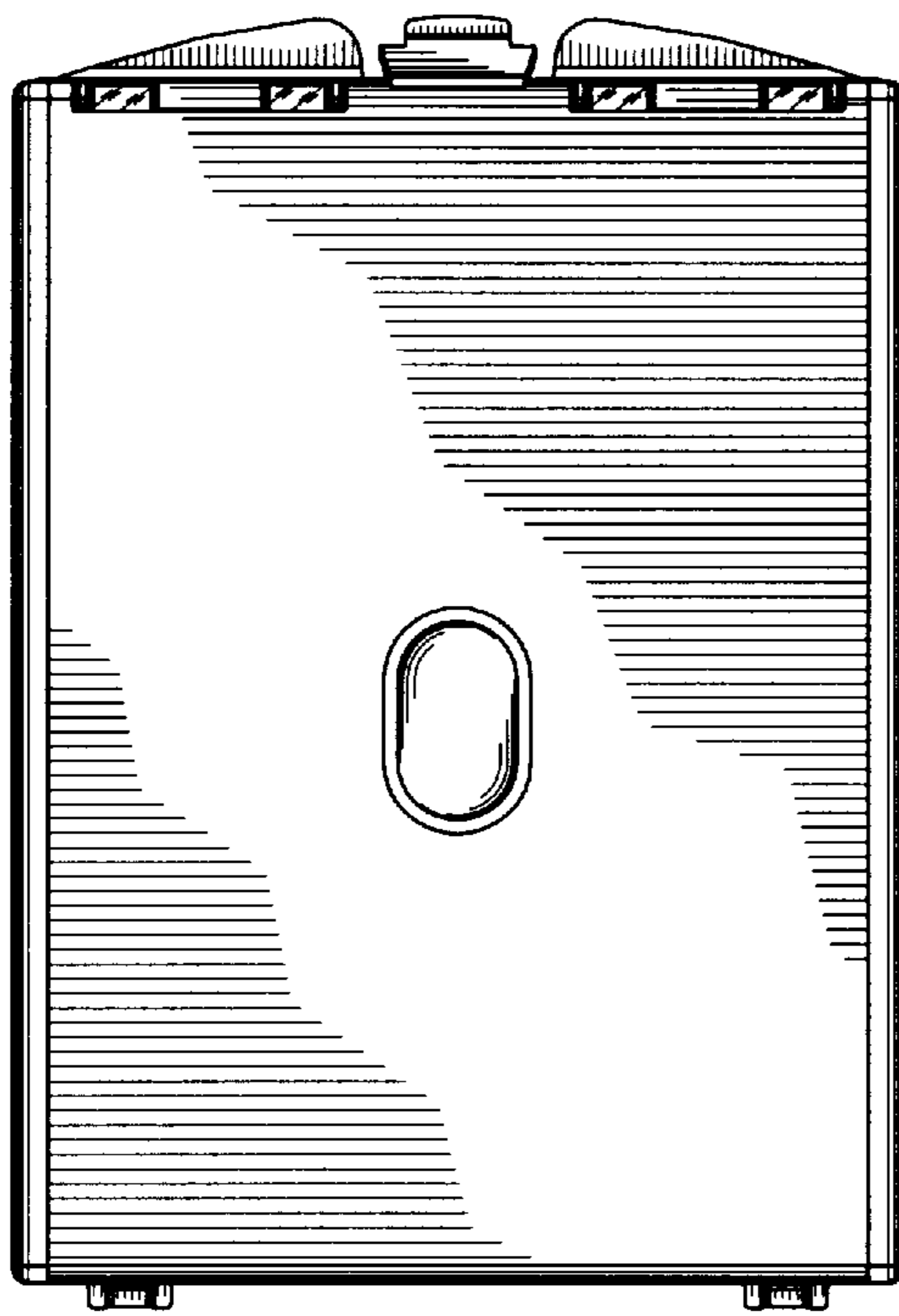
*FIG. 10*



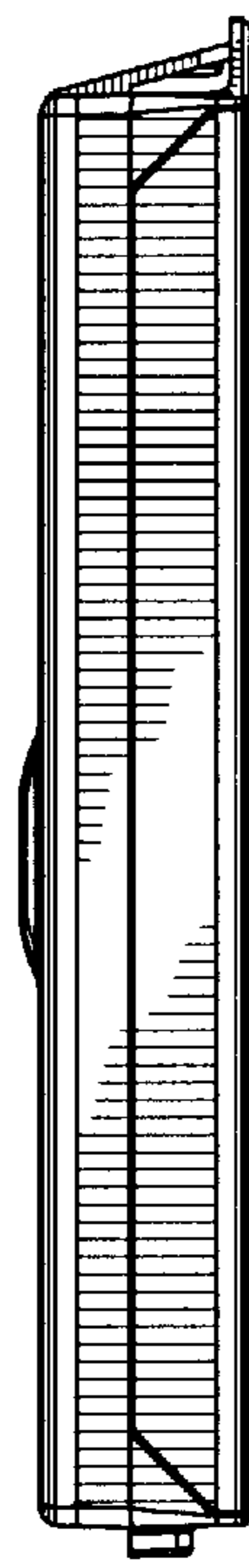
*FIG. 11*



*FIG. 12*



*FIG. 13*



*FIG. 14*