



US00D406043S

# United States Patent [19] LeClaire

[11] **Patent Number: Des. 406,043**

[45] **Date of Patent: \*\*Feb. 23, 1999**

[54] **SHROUDED LOCK**

[75] Inventor: **John LeClaire**, Brookfield, Wis.

[73] Assignee: **Master Lock Company**, Milwaukee, Wis.

[\*\*] Term: **14 Years**

[21] Appl. No.: **75,288**

[22] Filed: **Aug. 26, 1997**

[51] **LOC (6) Cl.** ..... **08-07**

[52] **U.S. Cl.** ..... **D8/334; D8/346**

[58] **Field of Search** ..... D8/333, 334, 346;  
70/20, 22, 24, 31, 35, 51-52, 54-56

[56] **References Cited**

**U.S. PATENT DOCUMENTS**

D. 296,519	7/1988	Newman et al. ....	D8/334
D. 314,908	2/1991	Pedersen .....	D8/334
D. 342,009	12/1993	Lebrecht et al. ....	D8/334
D. 379,919	6/1997	Mountain .....	D8/334
1,291,993	1/1919	Matthews .	
3,453,846	7/1969	Owen et al. .	
3,559,429	2/1971	Hermann .	
3,572,063	3/1971	Foote .	
3,721,112	3/1973	Wellekens .	
3,751,948	8/1973	Klein .	
3,783,657	1/1974	Foote .	

3,835,675	9/1974	Lippisch .	
4,576,022	3/1986	Gamble .	
4,686,840	8/1987	McCarroll .	
4,689,975	9/1987	Dunphy et al. .	
4,799,369	1/1989	Goodson et al. .	
4,829,795	5/1989	Taylor .	
4,883,294	11/1989	Goodspeed .	
4,905,486	3/1990	Appelbaum .	
5,033,279	7/1991	Lebrecht .....	70/55

**FOREIGN PATENT DOCUMENTS**

413366 4/1946 Italy .

*Primary Examiner*—Brian N. Vinson  
*Attorney, Agent, or Firm*—Pennie & Edmonds LLP

[57] **CLAIM**

The ornamental design for a shrouded lock, as shown and described.

**DESCRIPTION**

FIG. 1 is a perspective view of the shrouded lock;  
FIG. 2 is a front view thereof;  
FIG. 3 is rear view thereof;  
FIG. 4 is a left side view thereof;  
FIG. 5 is a right side view thereof;  
FIG. 6 is a top view thereof; and,  
FIG. 7 is a bottom view thereof.

**1 Claim, 3 Drawing Sheets**

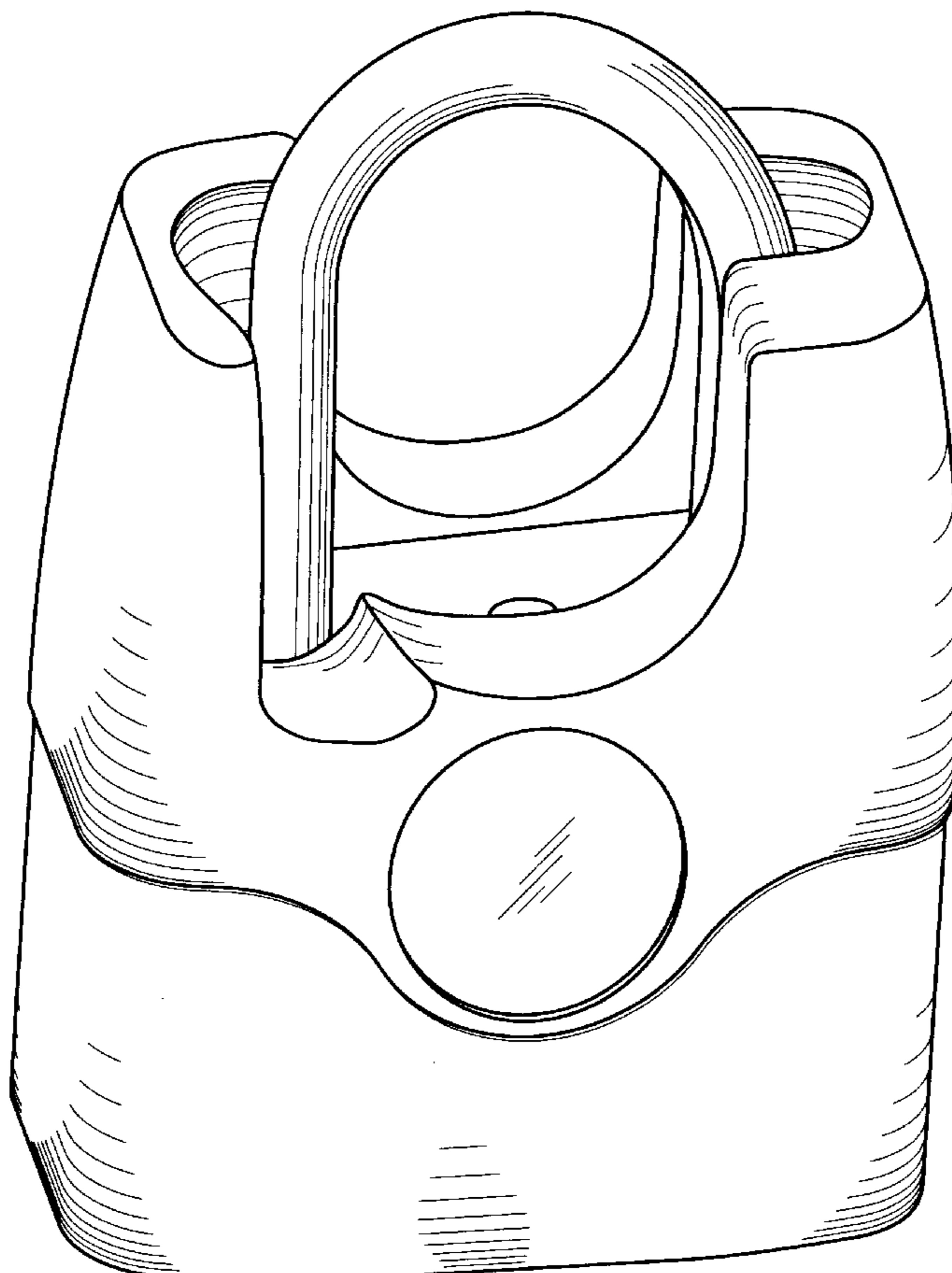

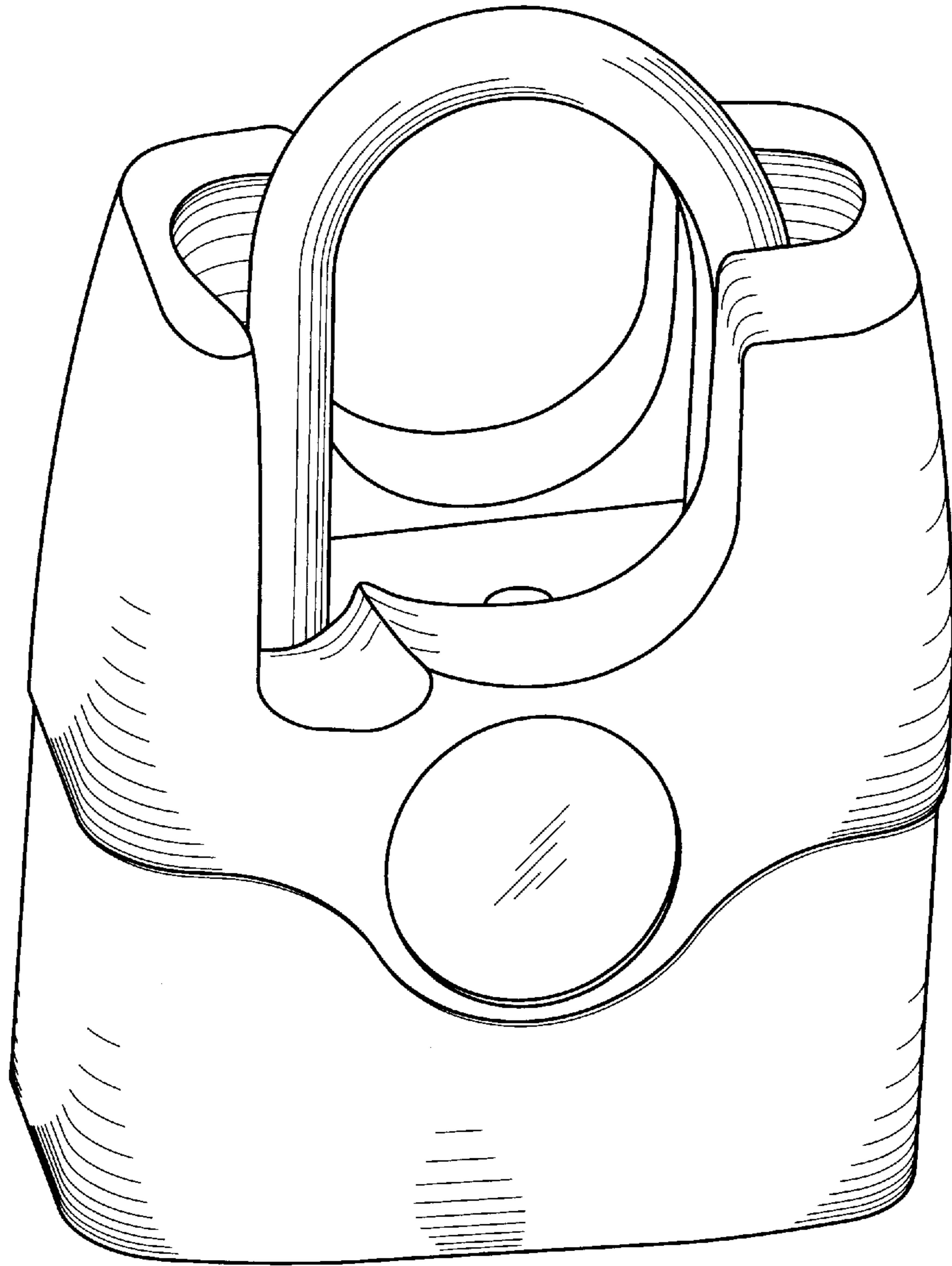

FIG. 1

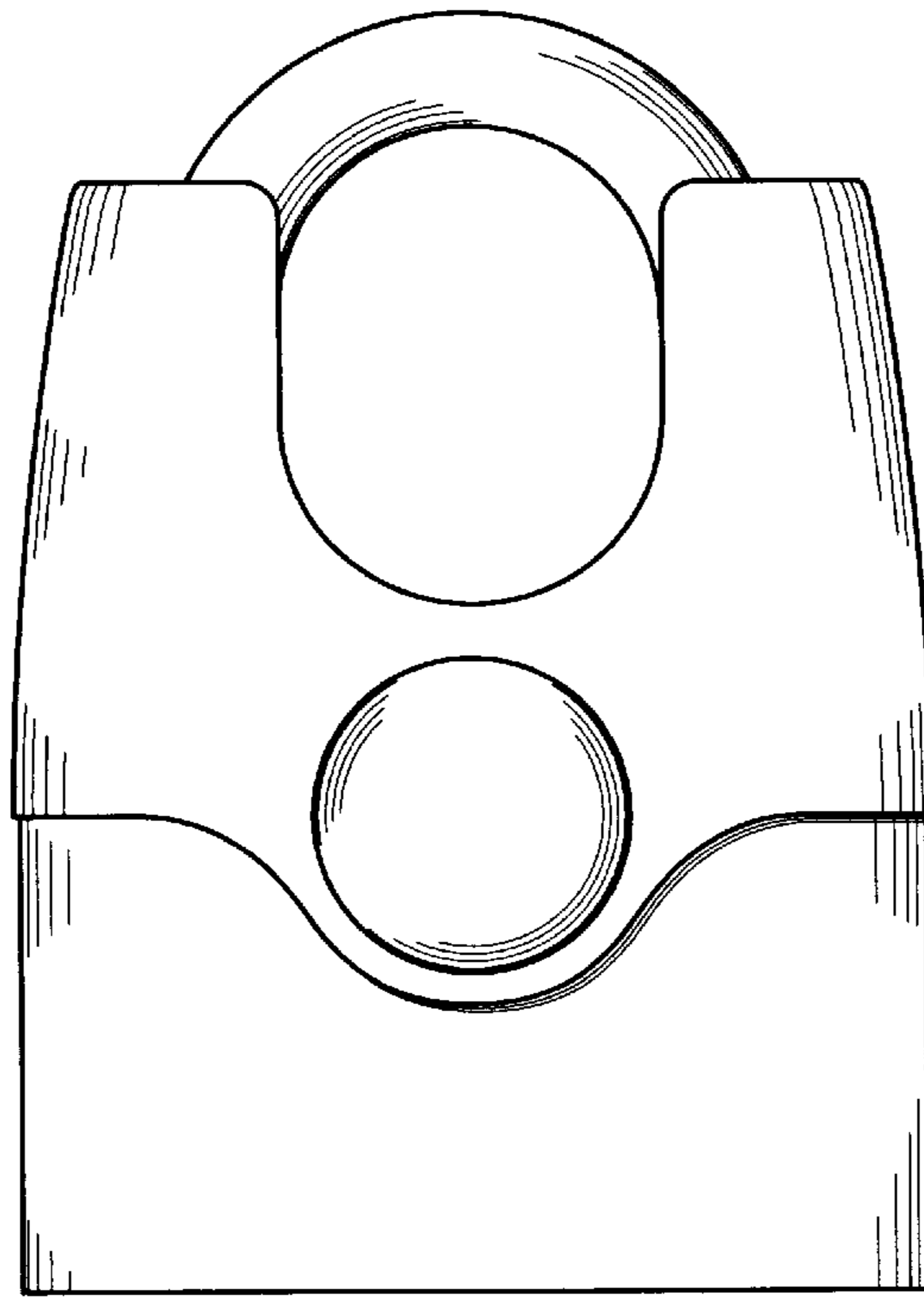

FIG. 2

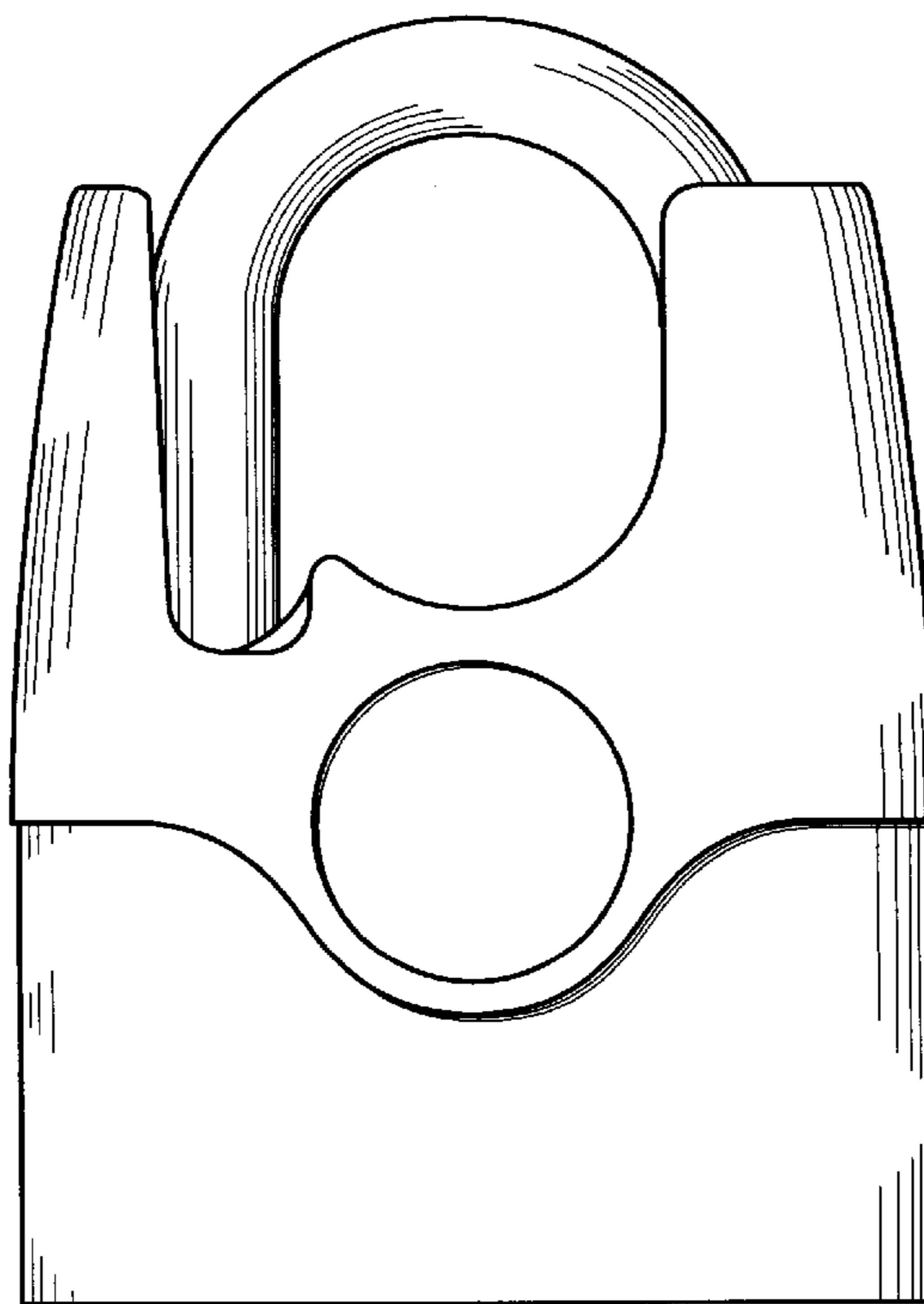

FIG. 3

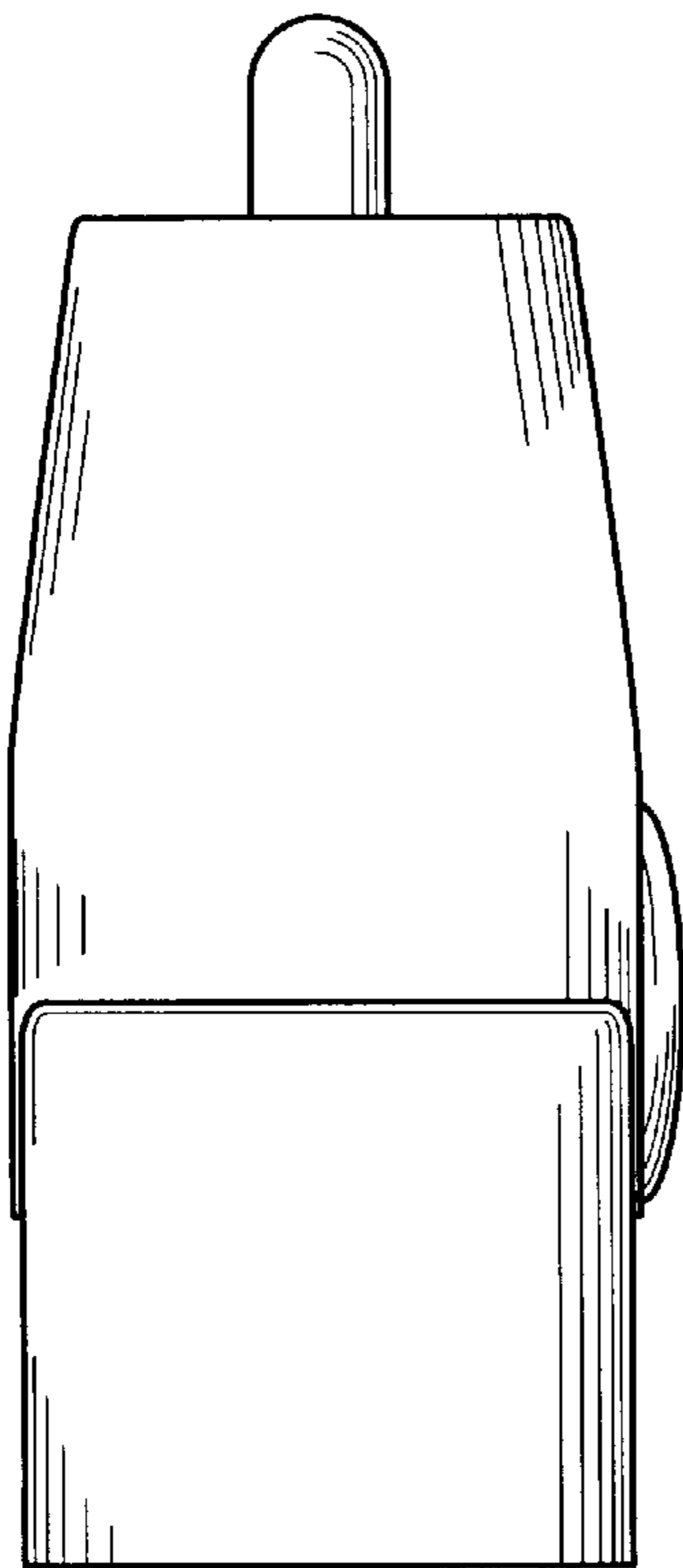

FIG. 4

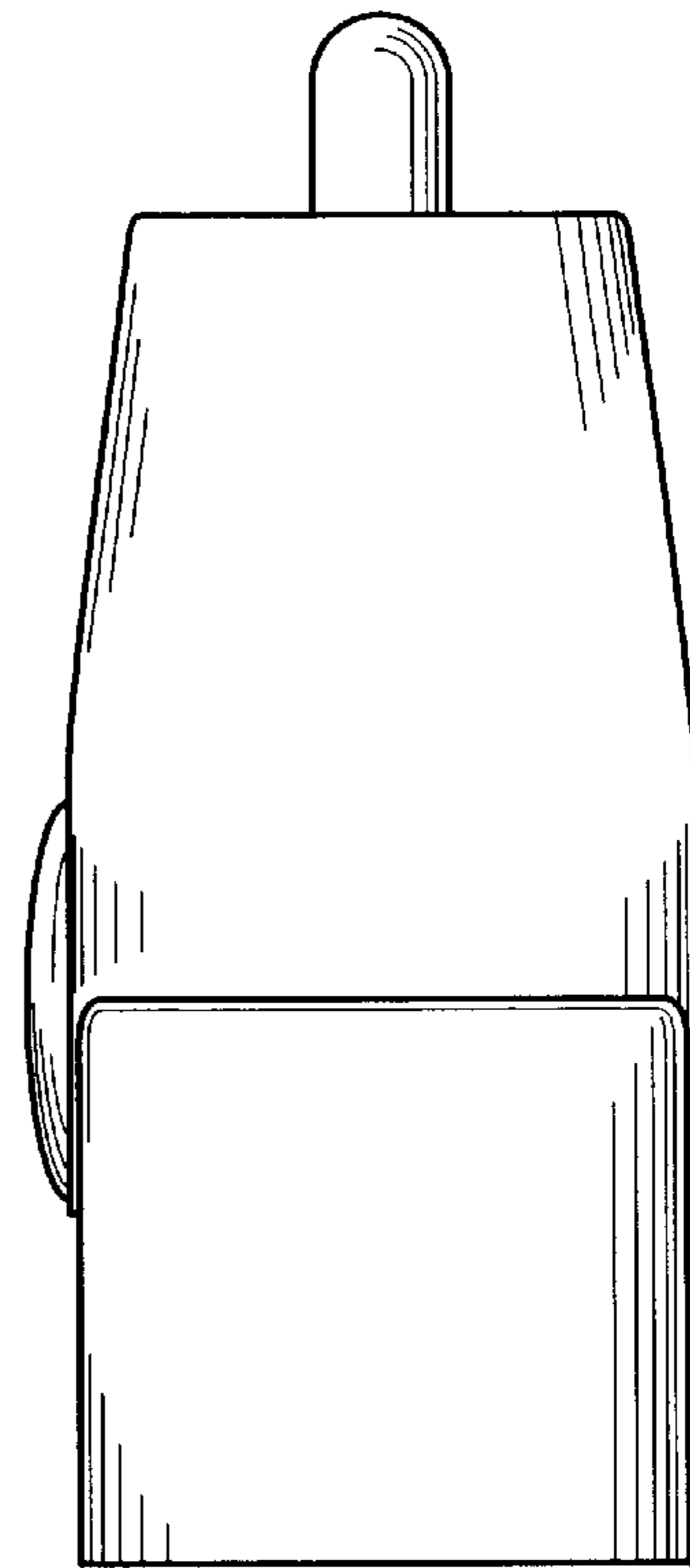

FIG. 5

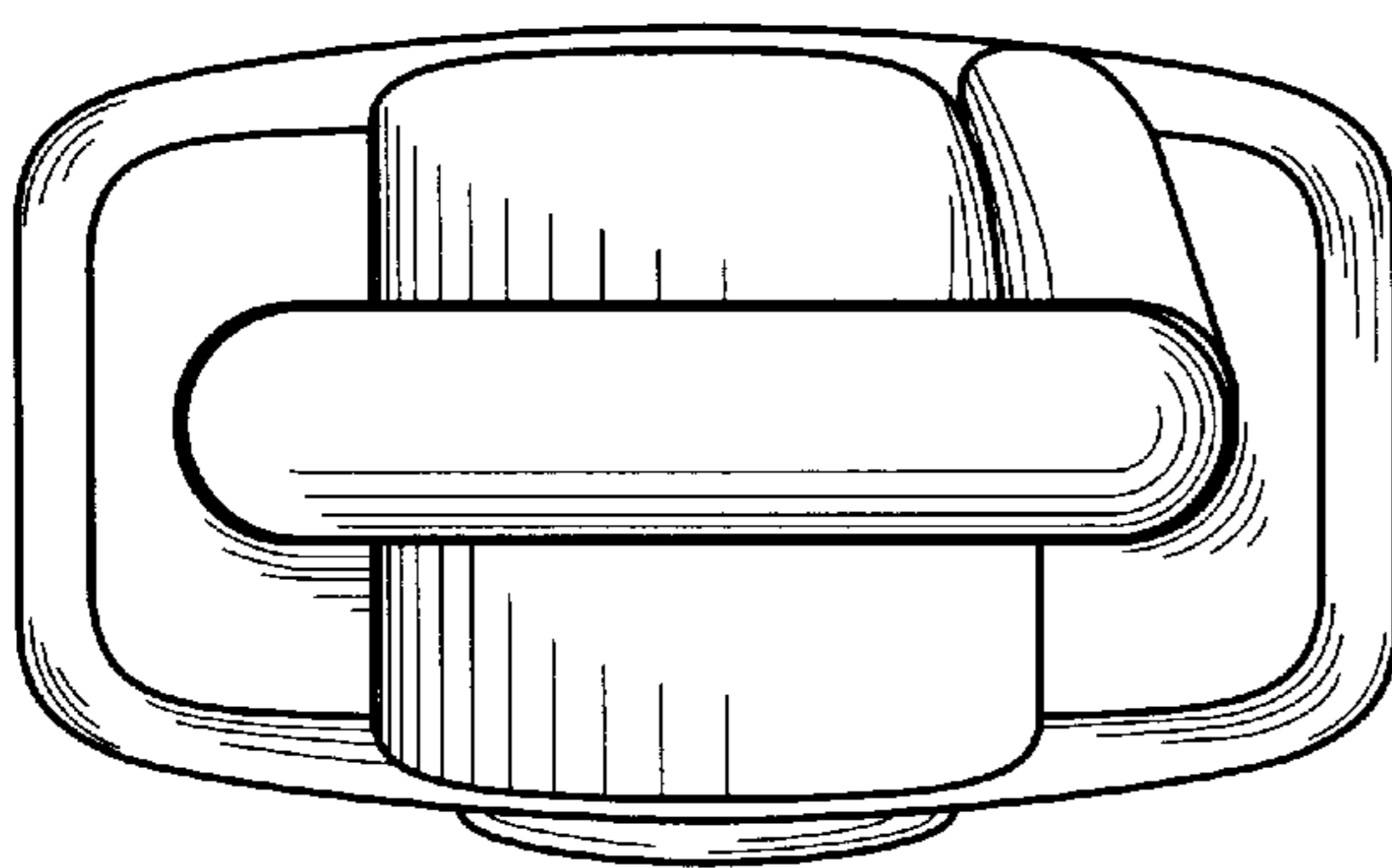

FIG. 6

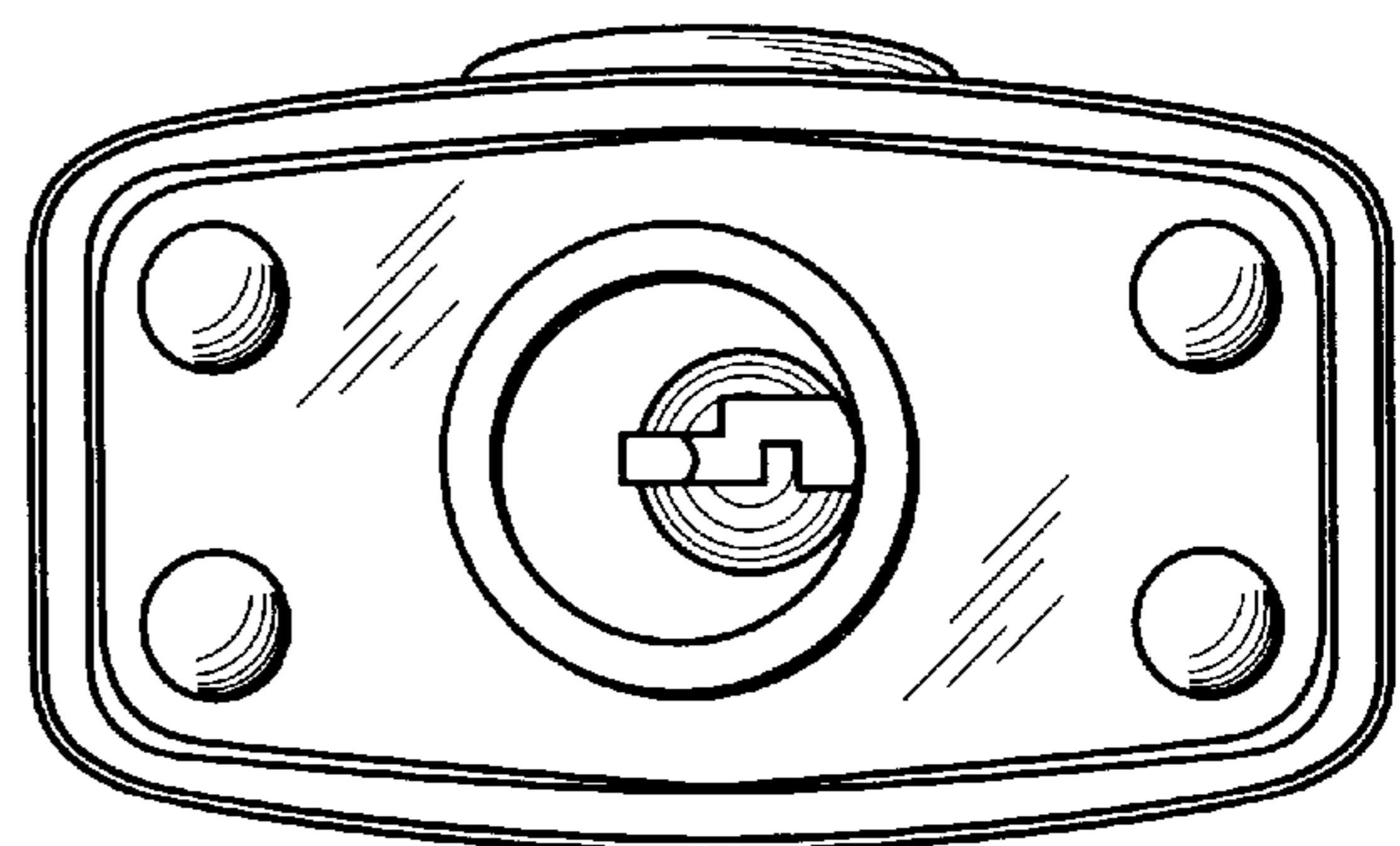

FIG. 7