



US00D406011S

United States Patent [19]

Hatsumoto et al.

[11] Patent Number: Des. 406,011

[45] Date of Patent: **Feb. 23, 1999

[54] CUP WITH LID

[75] Inventors: Kunio Hatsumoto; Yasuhiro Kowa; Takeshi Kuwana, all of Tokyo, Japan

[73] Assignee: Nippon Sanso Corporation, Tokyo, Japan

[**] Term: 14 Years

[21] Appl. No.: 77,643

[22] Filed: Oct. 8, 1997

[30] Foreign Application Priority Data

Apr. 10, 1997 [JP] Japan 9-50826

[51] LOC (6) Cl. 07-01

[52] U.S. Cl. D7/510; D7/511

[58] Field of Search D7/622, 507, 509, D7/510, 511, 513, 515, 523, 533, 536, 300.1, 619; 220/703, 705, 717-709, 713, 737, 739, 625

[56] References Cited

U.S. PATENT DOCUMENTS

- D. 177,575 5/1956 Louik D7/511
- D. 214,458 6/1969 Riley D7/507
- D. 231,068 4/1974 Douglas D7/533
- D. 331,684 12/1992 Trombley D7/536
- D. 338,367 8/1993 Fonville D7/316 X
- D. 346,933 5/1994 Denny et al. D7/536
- D. 362,369 9/1995 Bridges D7/536
- D. 363,414 10/1995 Goto et al. D7/533
- D. 363,641 10/1995 Goto et al. D7/511
- D. 363,666 10/1995 Goto et al. .
- D. 364,071 11/1995 Lynd D7/510
- D. 364,319 11/1995 Schaeppi D7/536
- D. 369,063 4/1996 Meisner D7/533
- D. 370,384 6/1996 Shamis D7/622 X
- D. 372,838 8/1996 Feltman et al. D7/533 X

- D. 372,839 8/1996 Laib D7/536
- D. 382,174 8/1997 Grimm D7/510
- D. 386,948 12/1997 Wissinger D7/533
- 4,276,992 7/1981 Susich D7/510 X
- 5,531,353 7/1996 Ward et al. D7/511 X
- 5,590,808 1/1997 Schaeppi 220/737

FOREIGN PATENT DOCUMENTS

- 943713 1/1996 Japan .
- 955180 6/1996 Japan .
- 964813 9/1996 Japan .

Primary Examiner—M. N. Pandozzi
Attorney, Agent, or Firm—McDermott, Will & Emery

[57] CLAIM

We claim the ornamental design for the cup with lid, as shown and described.

DESCRIPTION

FIG. 1 is a perspective view from the front direction of a cup with lid showing our new design;
 FIG. 2 is a perspective view from the rear direction thereof;
 FIG. 3 is a front elevational view thereof;
 FIG. 4 is a rear elevational view thereof;
 FIG. 5 is a left side elevational view thereof;
 FIG. 6 is a right side elevational view thereof;
 FIG. 7 is a top plan view thereof;
 FIG. 8 is a bottom plan view thereof;
 FIG. 9 is a cross-sectional view thereof, taken along line 9—9 of FIG. 3;
 FIG. 10 is a cross-sectional view thereof, taken along line 10—10 of FIG. 6;
 FIG. 11 is a top plan view thereof, the lid with a tab in an open position; and
 FIG. 12 is a cross-sectional view thereof, taken along line 12—12 of FIG. 13 depicting the lid in an open position; and,
 FIG. 13 is a front elevational view thereof depicting the lid in the open position.

1 Claim, 11 Drawing Sheets

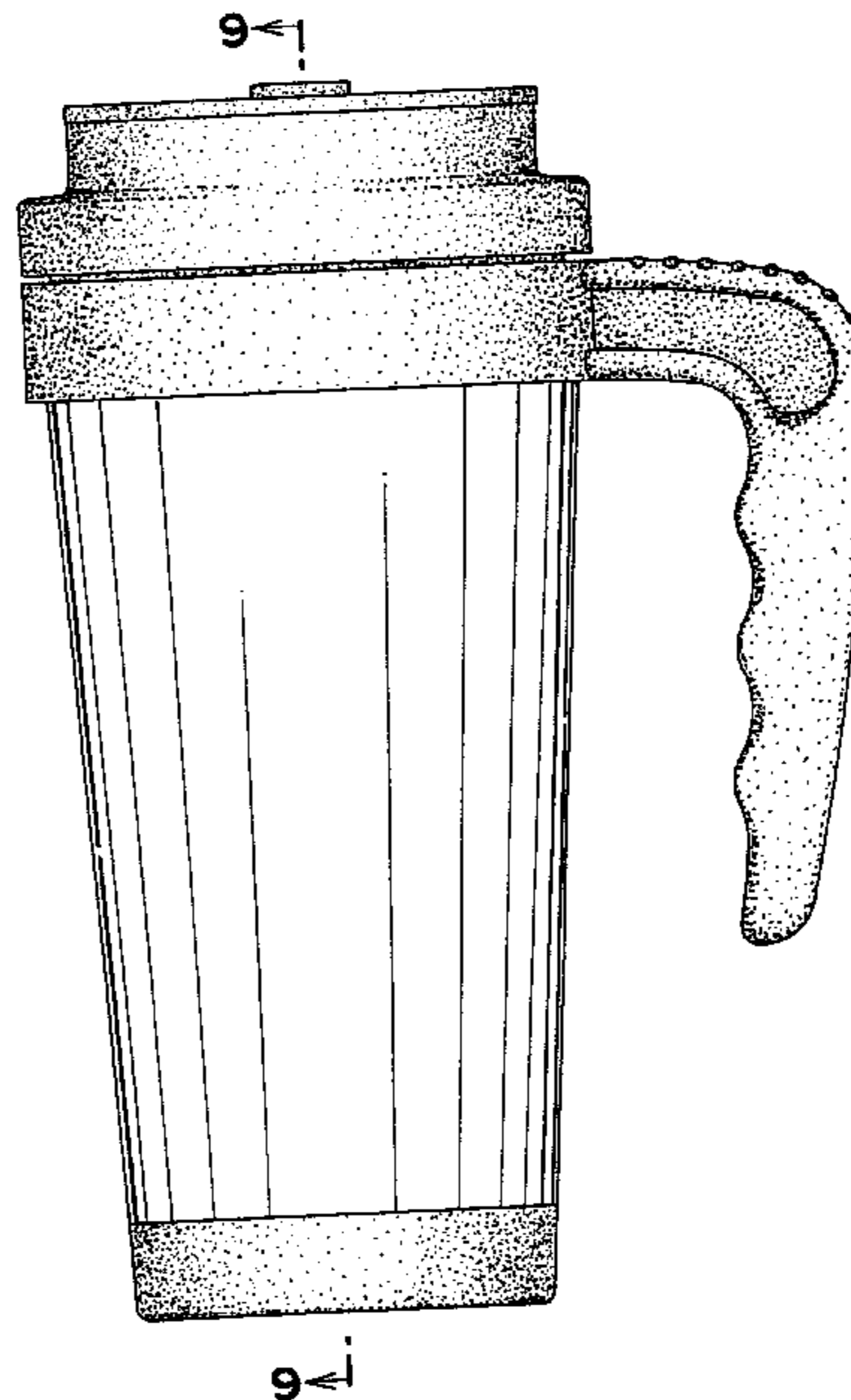
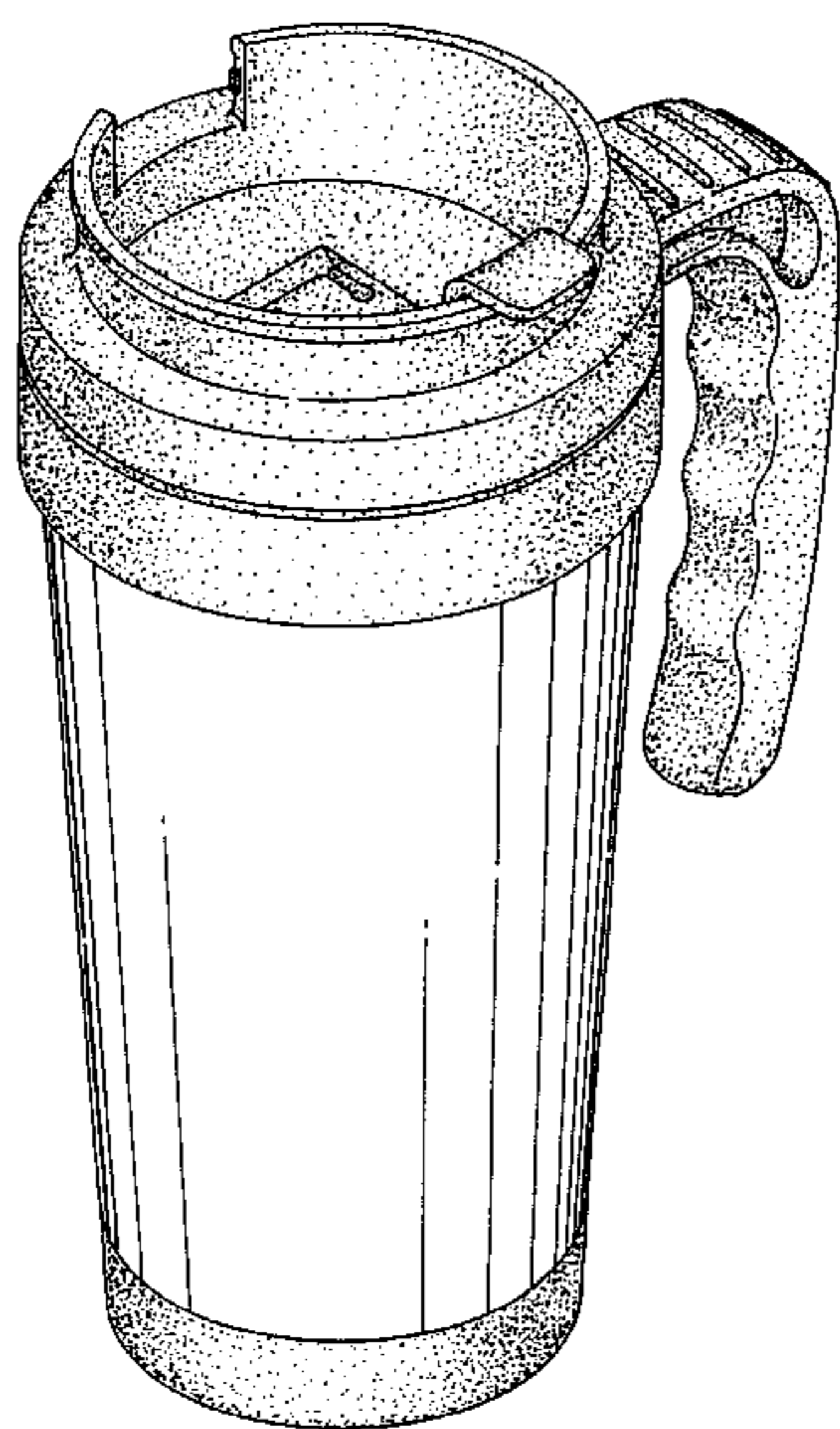

FIG. 1

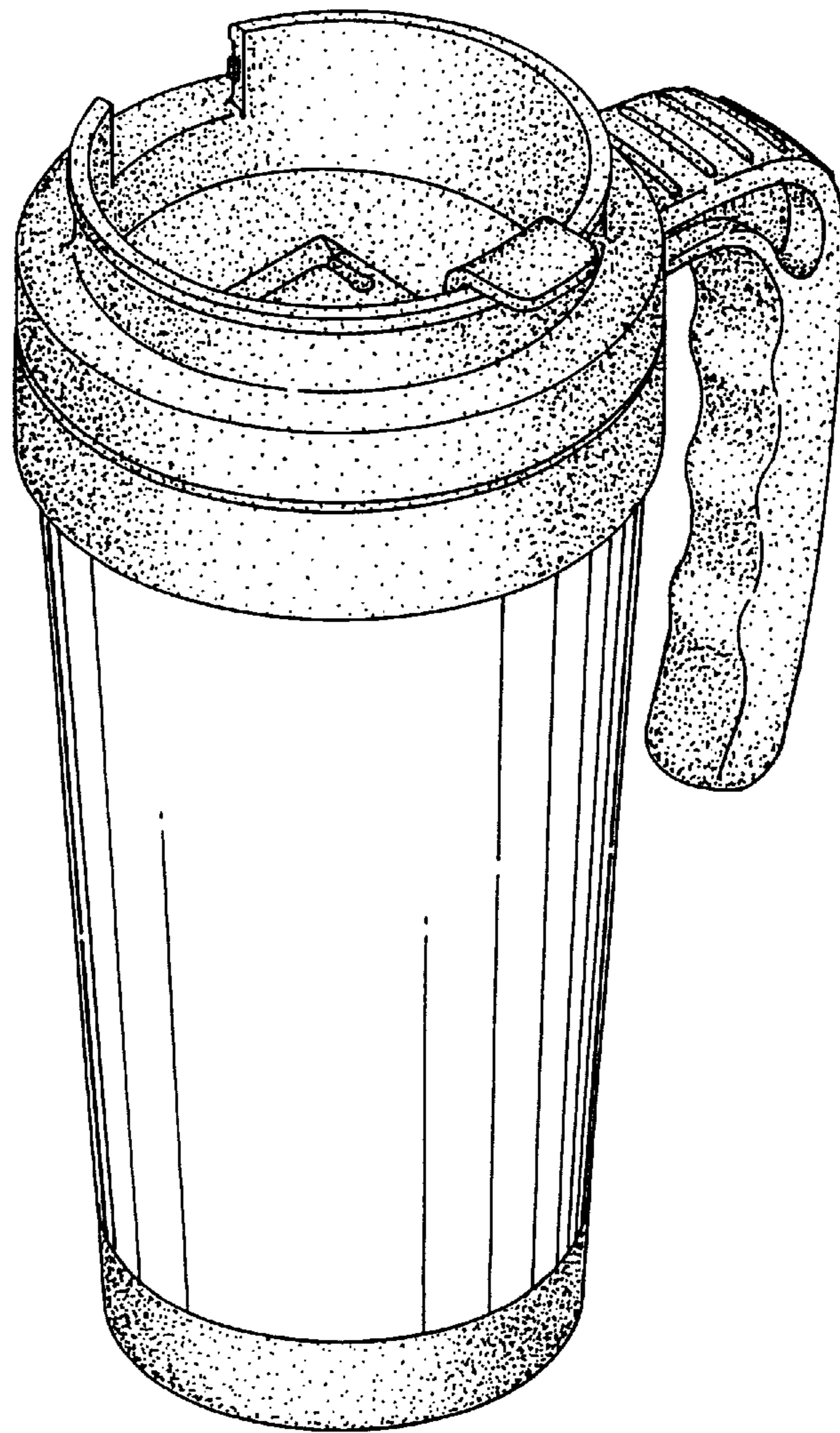

FIG. 2

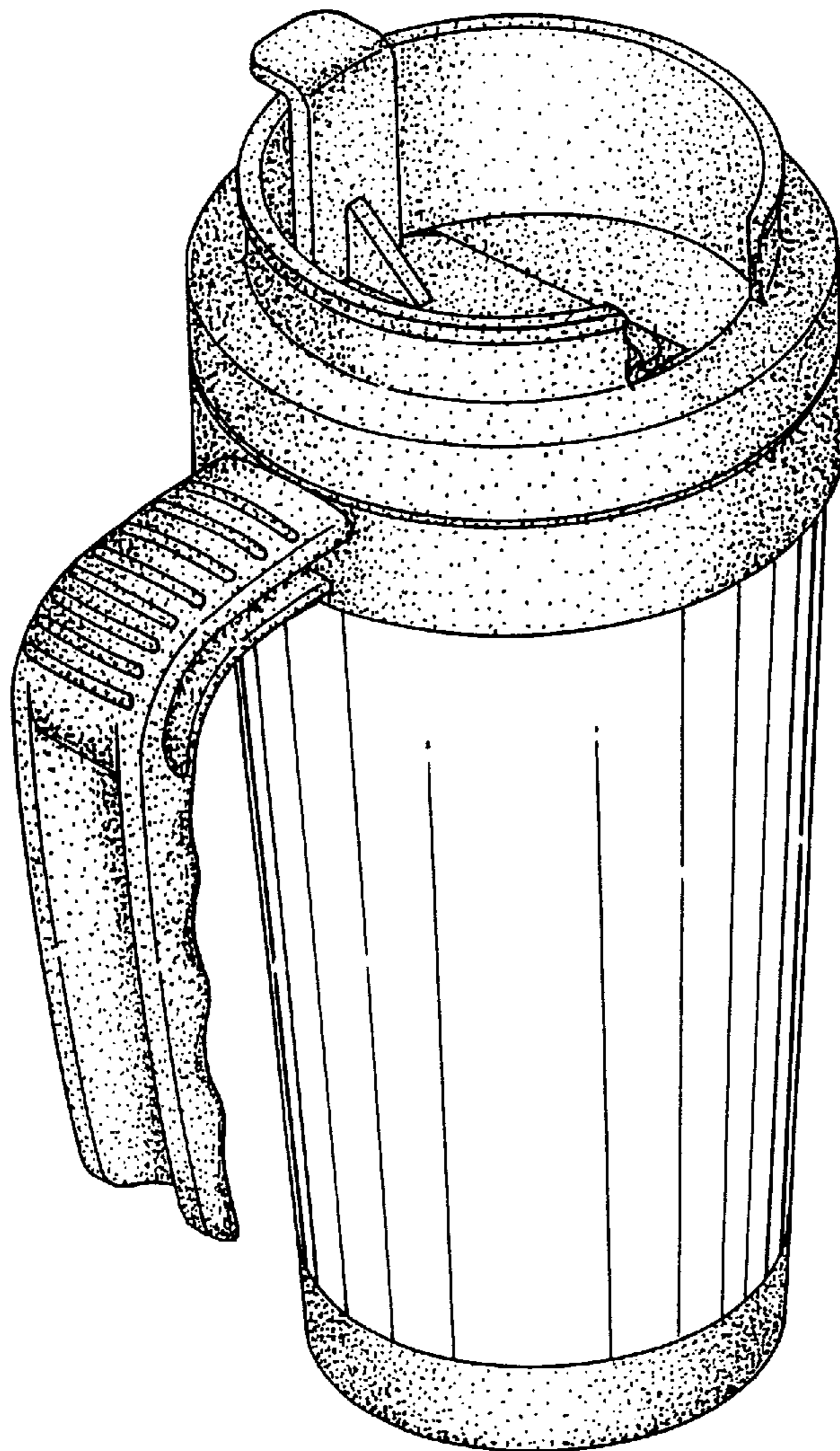

FIG. 3

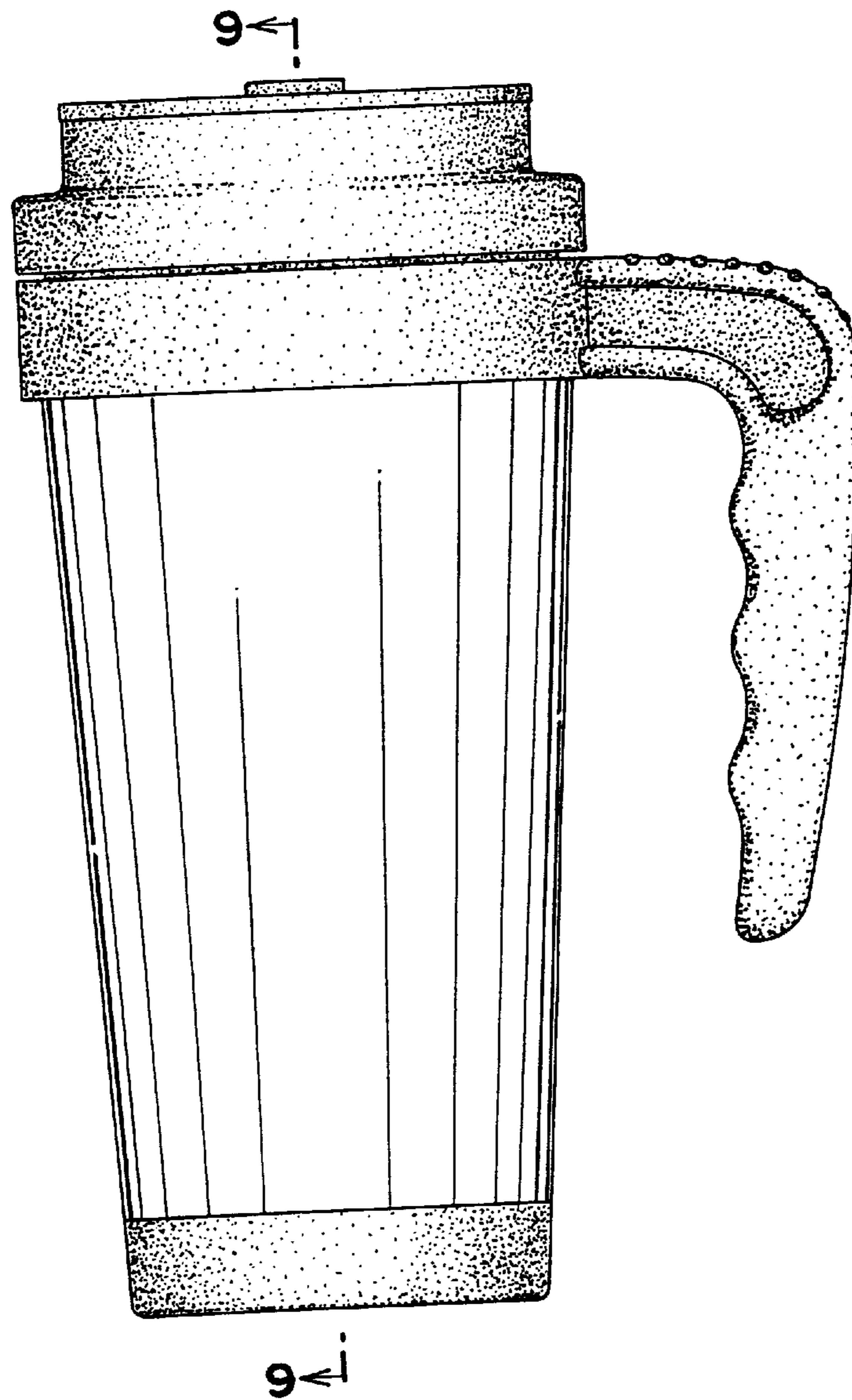

FIG. 4

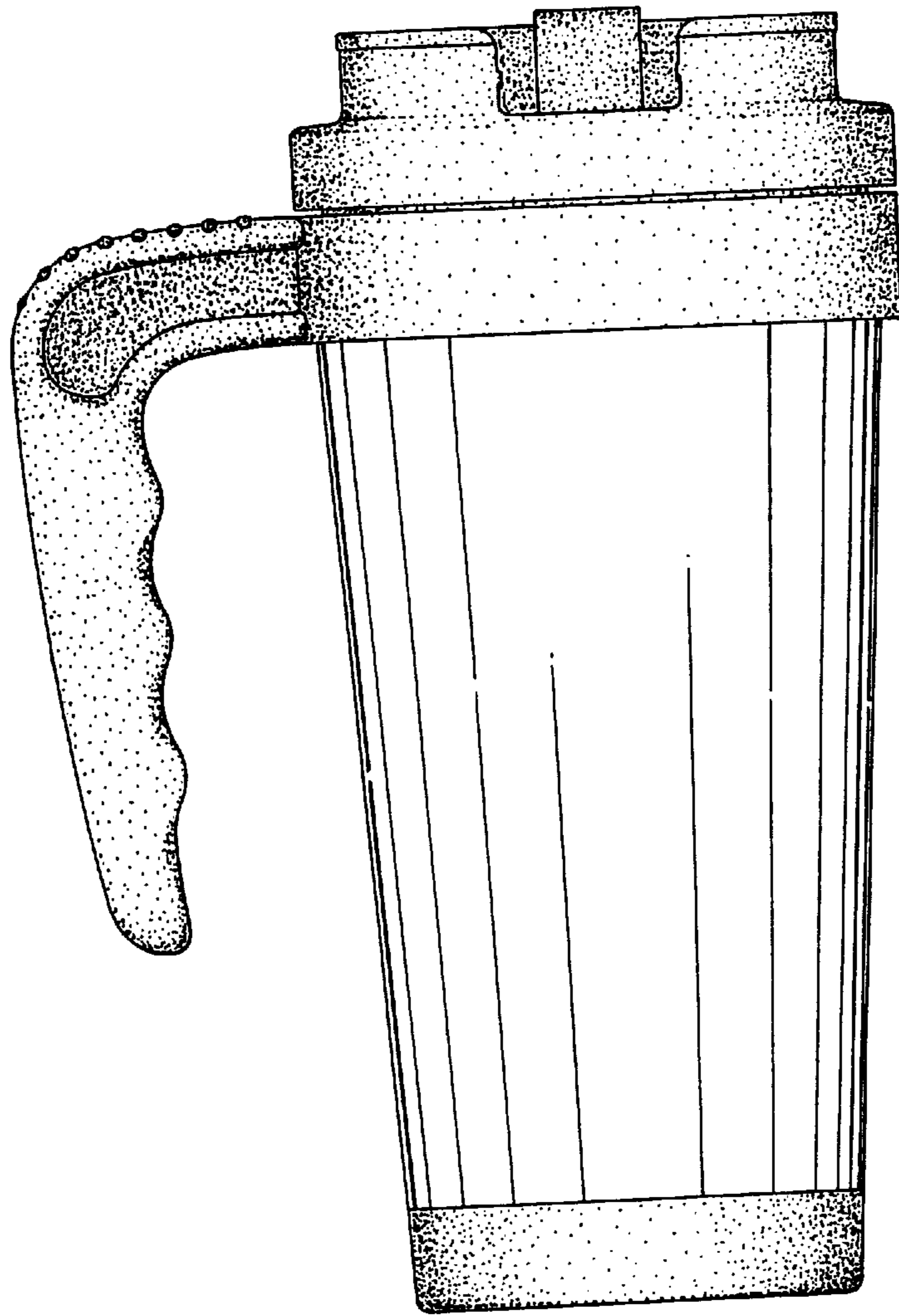

FIG. 5

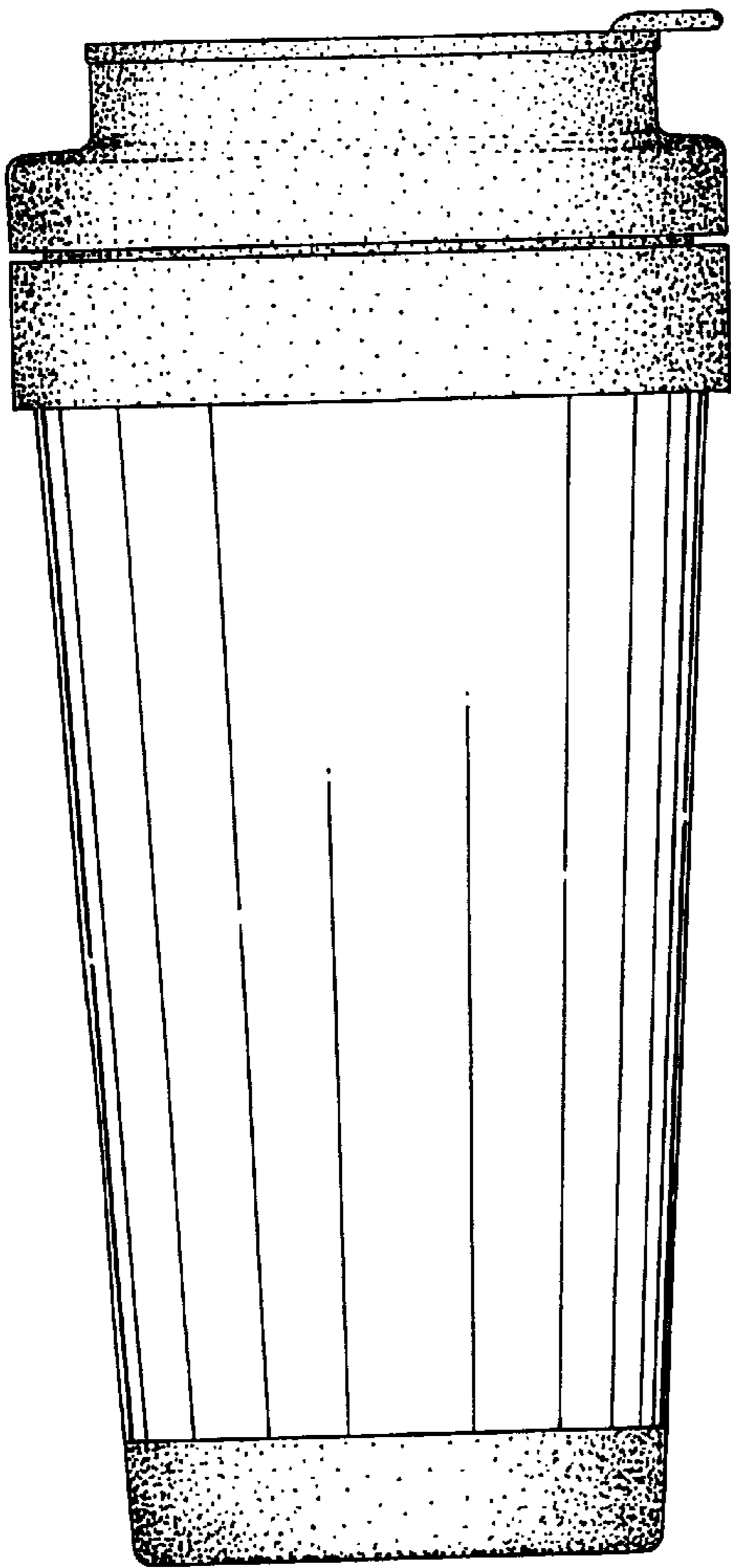
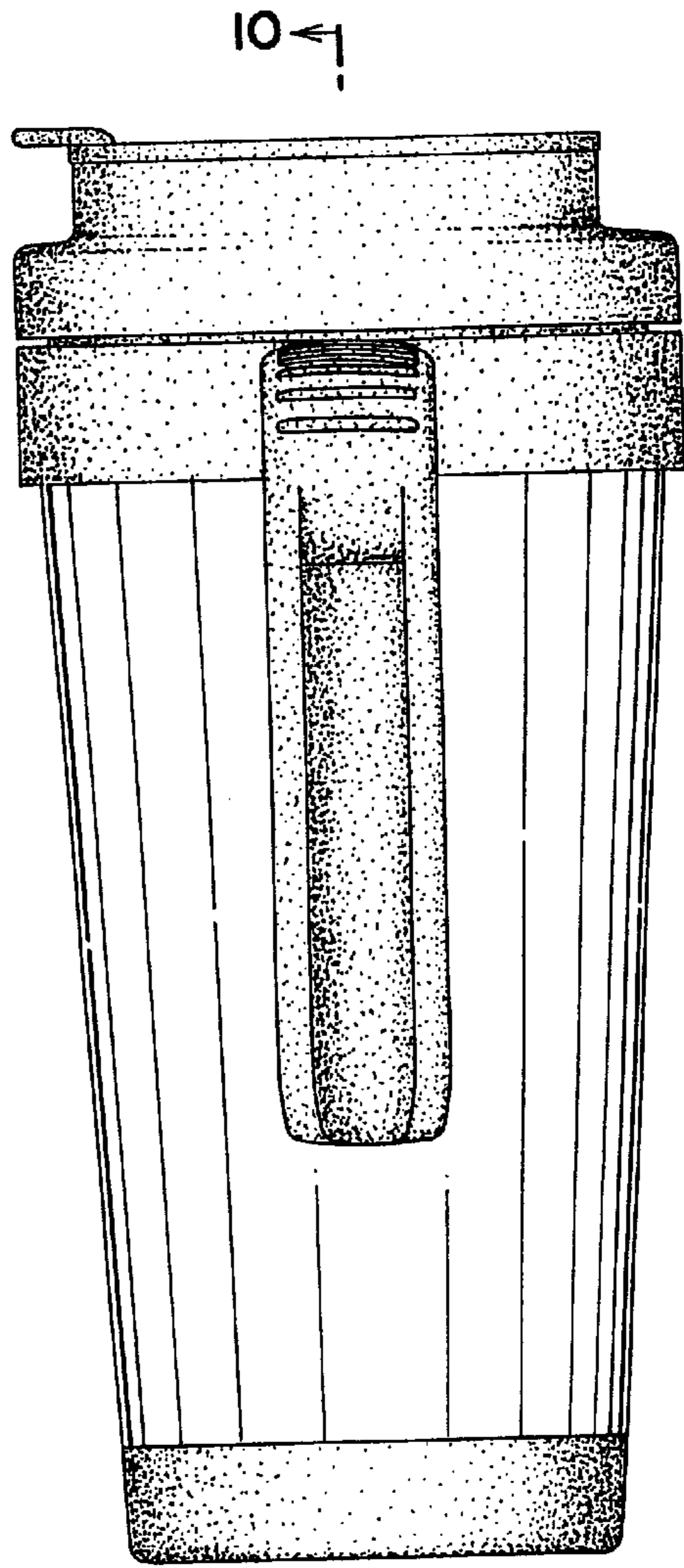

FIG. 6



10 ←

10 ←

FIG. 7

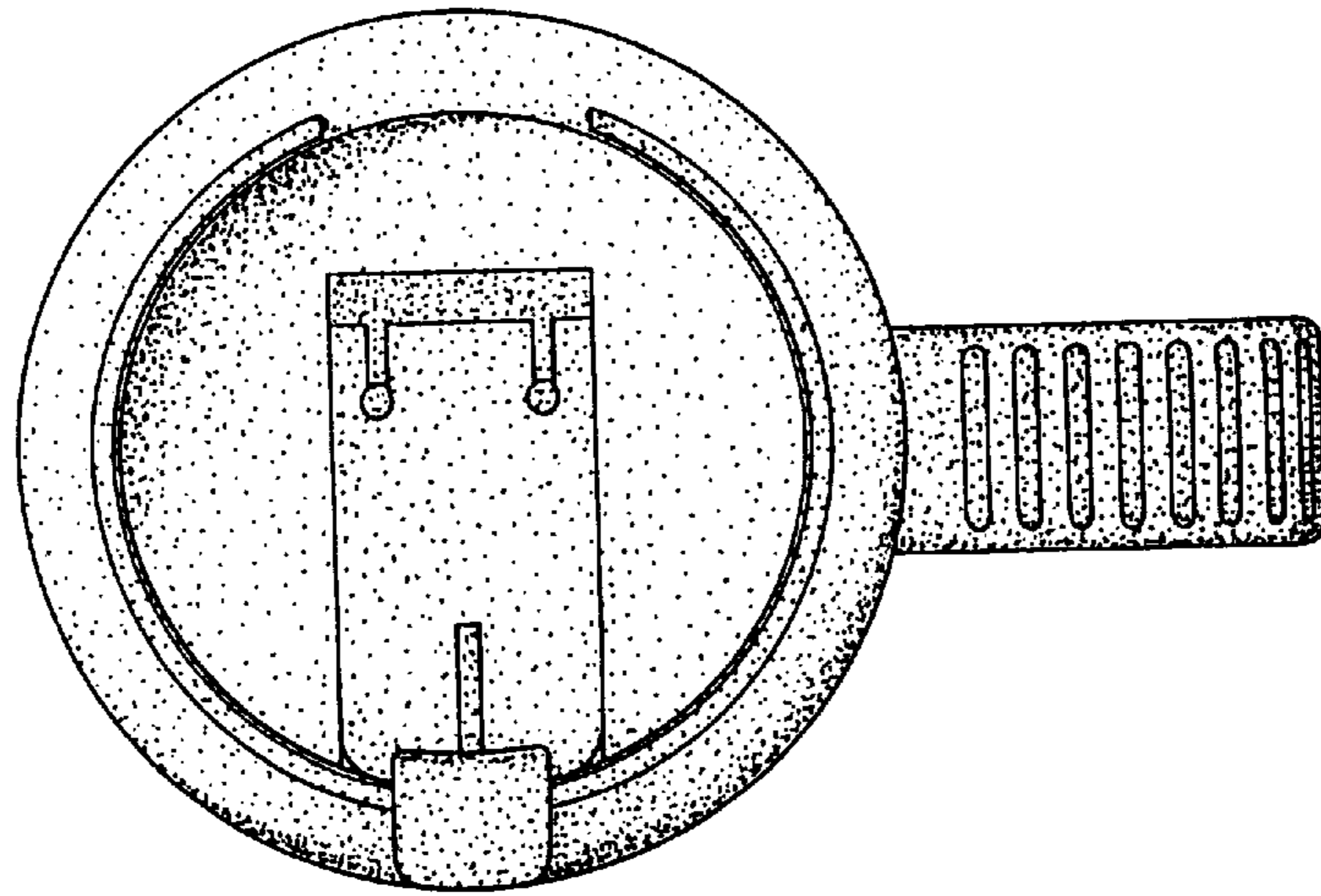

FIG. 8

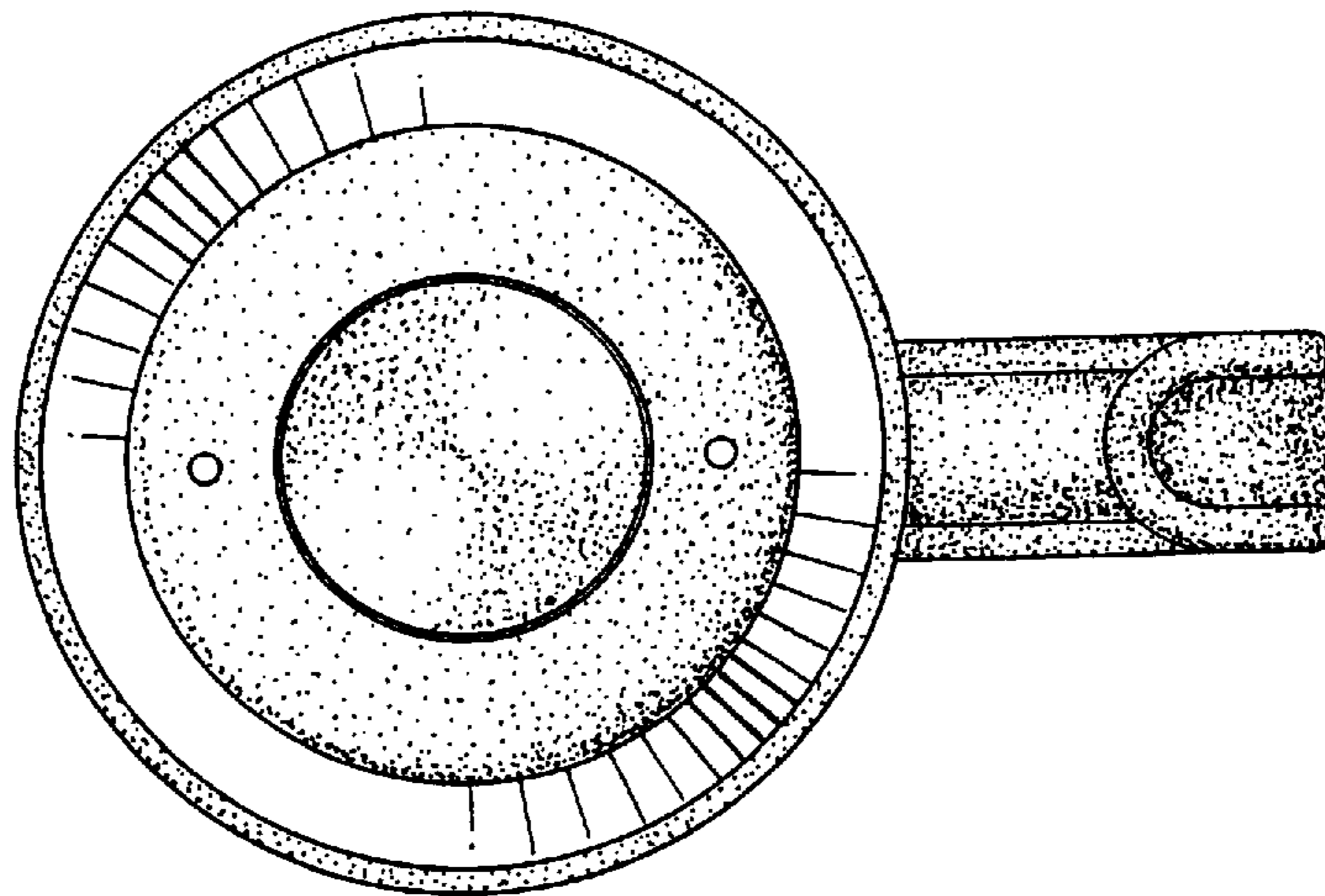

FIG. 9

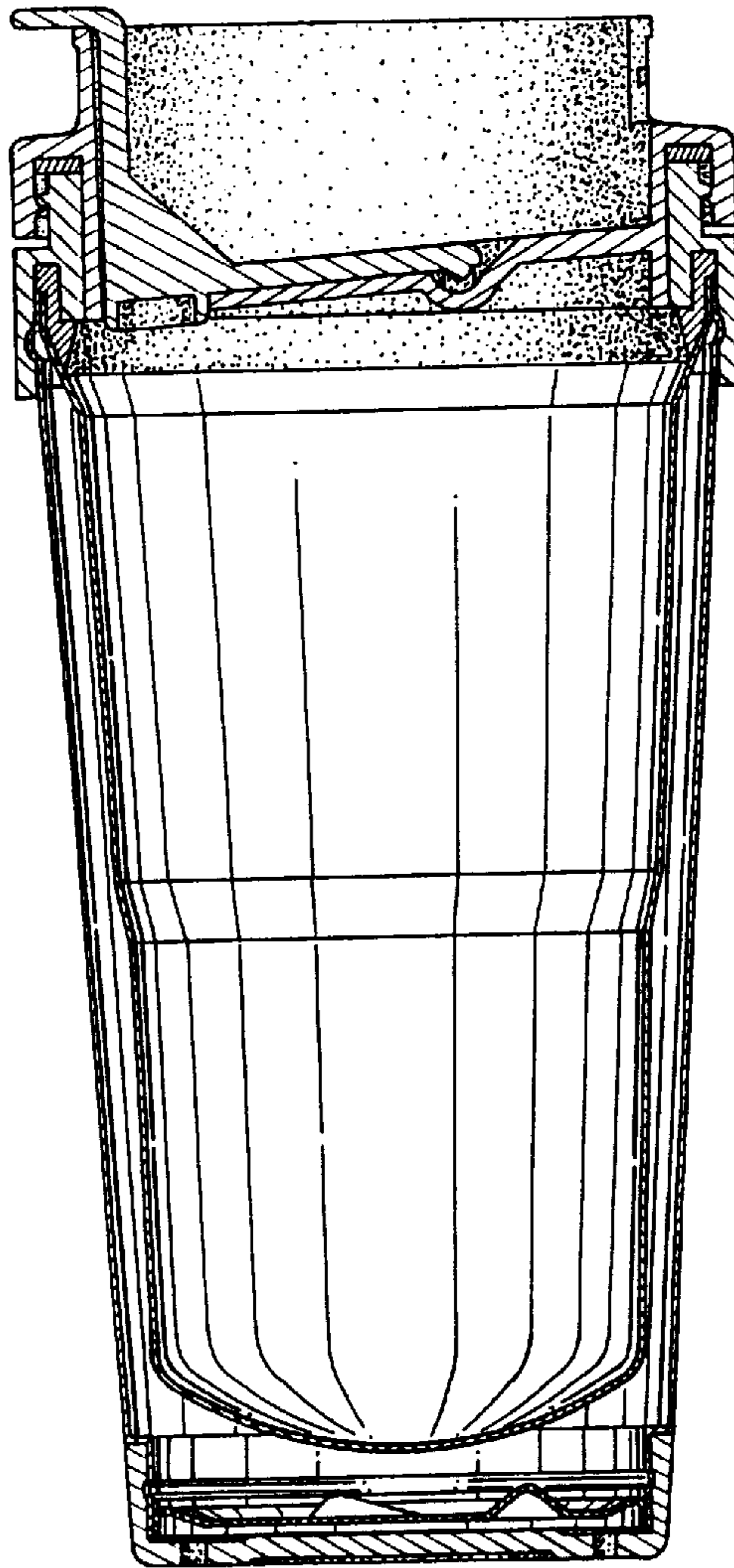

FIG. 10

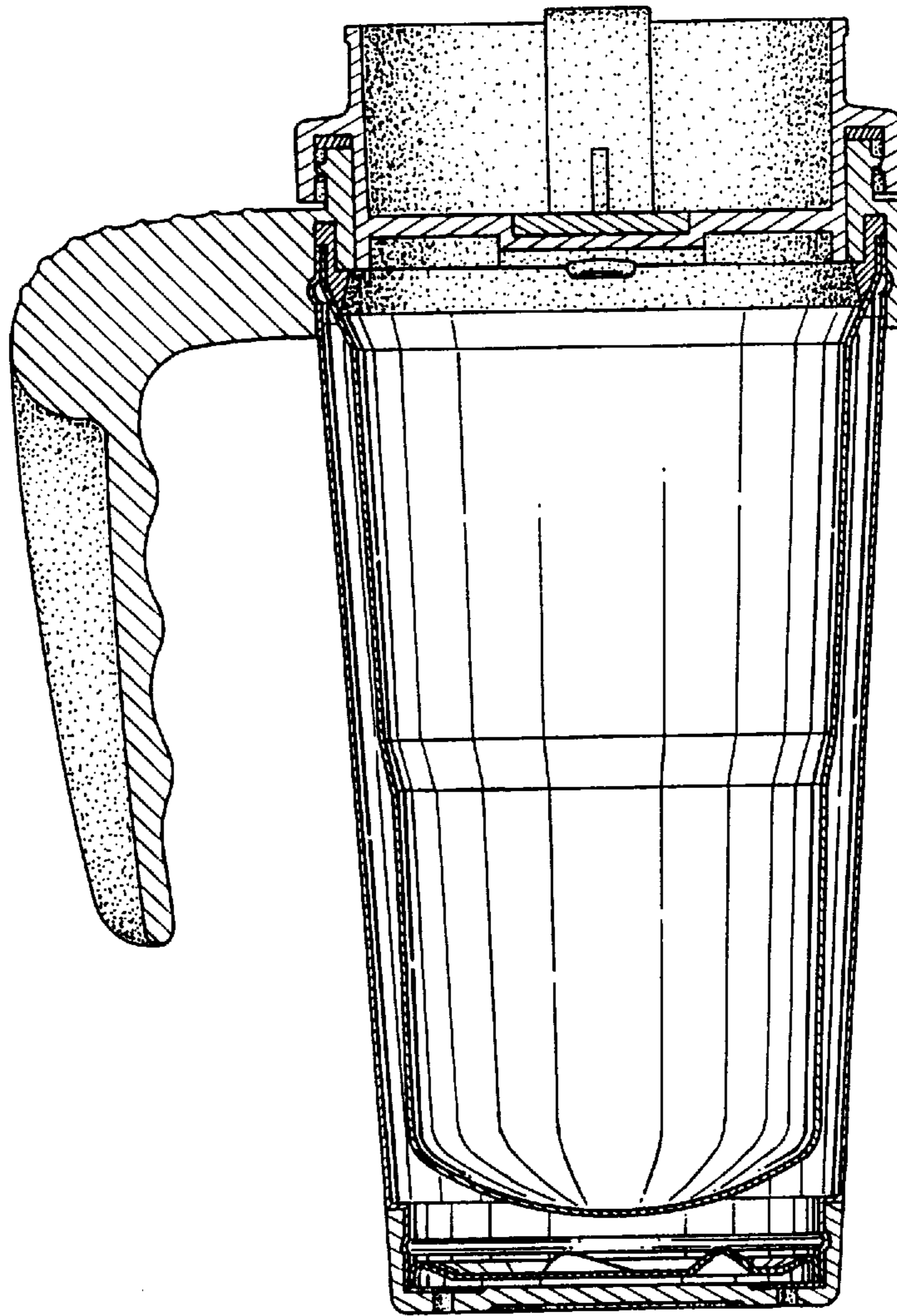

FIG. 11

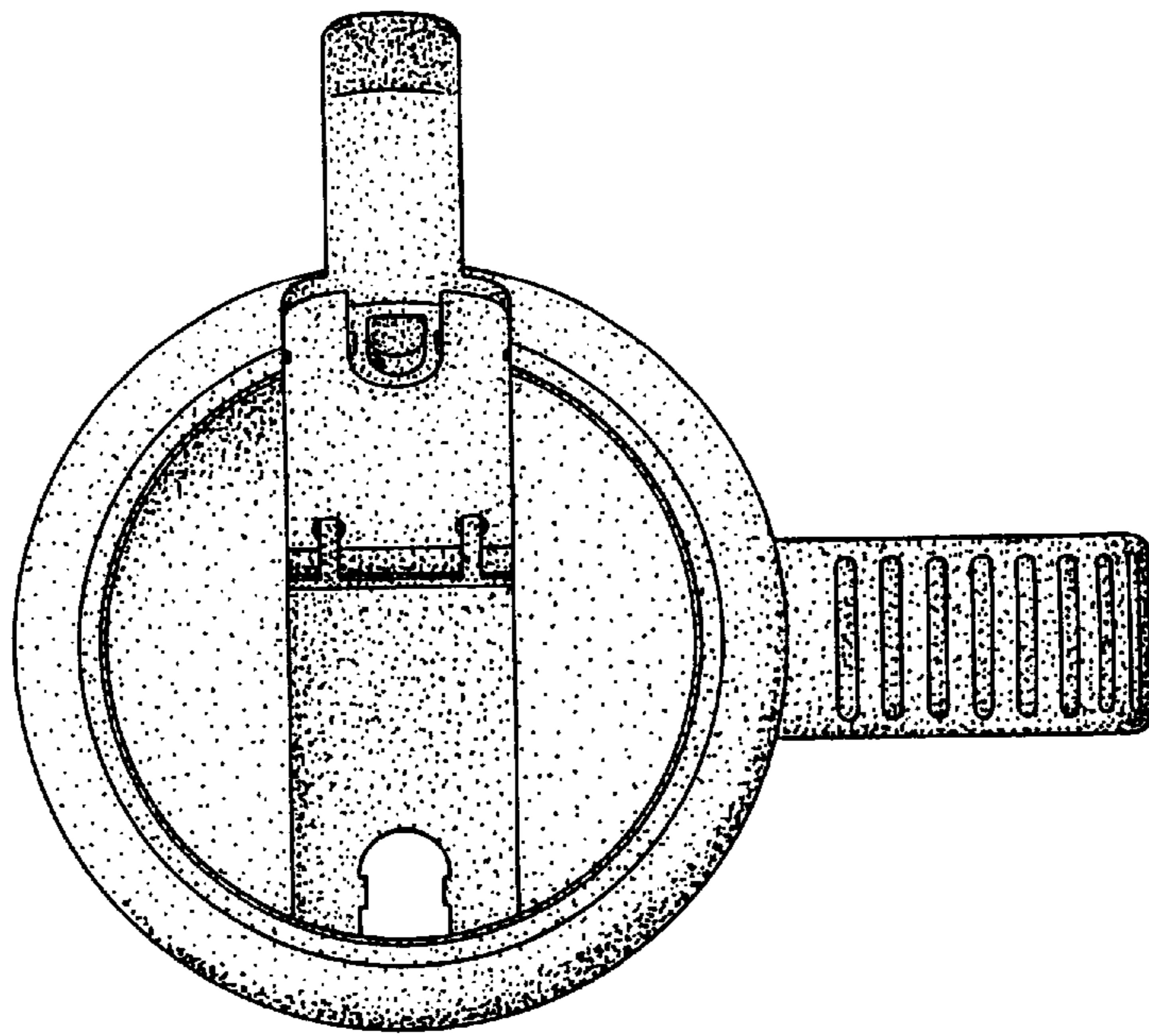

FIG. 12

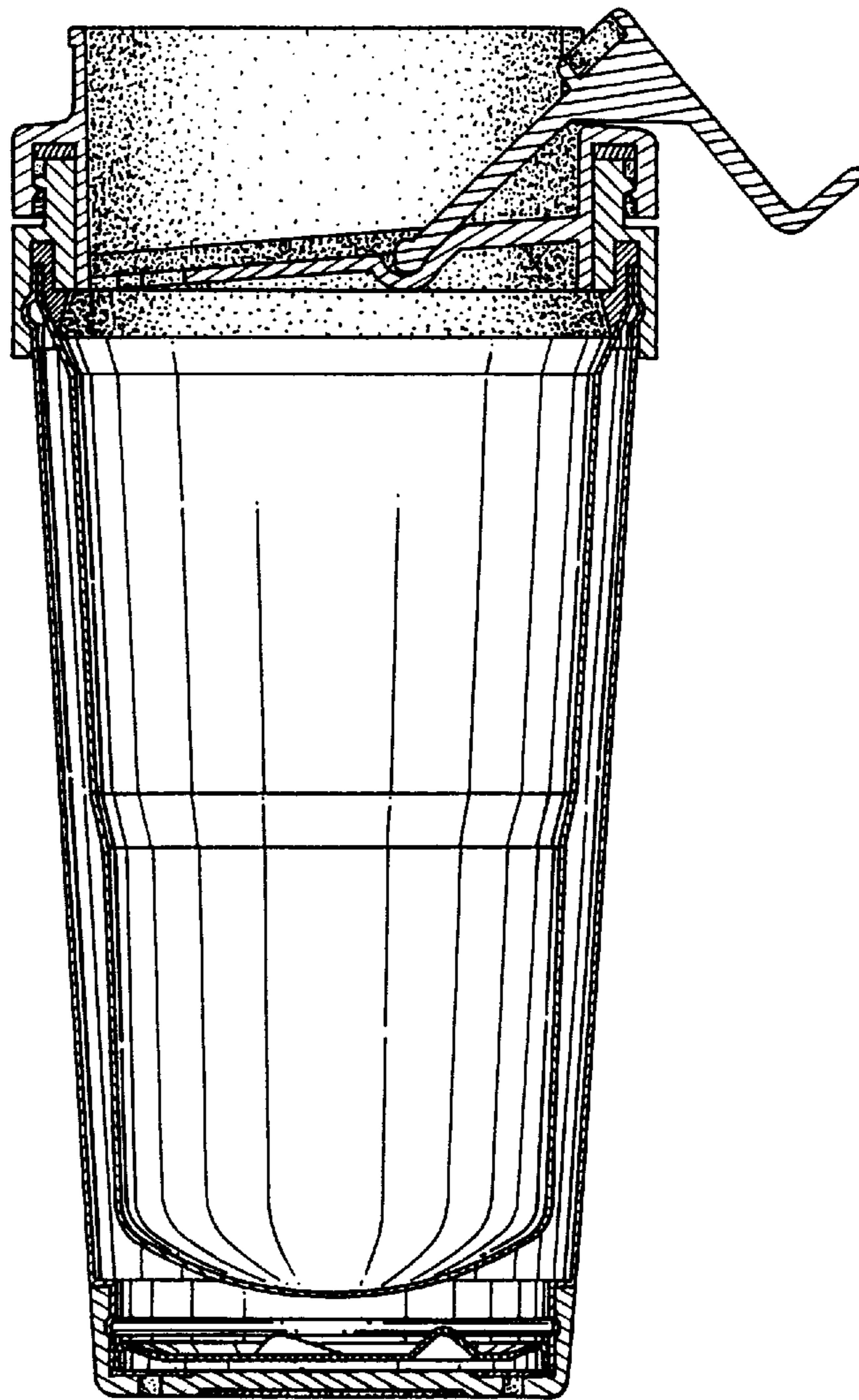

FIG. 13

