



US00D405926S

# United States Patent [19]

Badillo

[11] Patent Number: Des. 405,926

[45] Date of Patent: \*\*Feb. 16, 1999

[54] ASSEMBLY OF A PLAY BALL FOR CONTAINING SOAP AND ATTACHED CHILDREN'S WASH CLOTH

[76] Inventor: Connie M. Badillo, 2518 N. Shady Forest, Orange, Calif. 92867

[\*\*] Term: 14 Years

[21] Appl. No.: 82,583

[22] Filed: Dec. 30, 1997

[51] LOC (6) Cl. .... 28-03

[52] U.S. Cl. .... D28/63

[58] Field of Search ..... D4/137; D6/536, D6/539; D28/5, 6, 8.2, 20, 22, 63; D32/40, 43; 15/227, 104.94

### [56] References Cited

#### U.S. PATENT DOCUMENTS

D. 230,814	3/1974	Everts	.....	D28/63 X
D. 365,891	1/1996	Gargano et al.	.....	D28/63
D. 389,603	1/1998	Roman et al.	.....	D28/63
D. 390,723	10/1998	Thorpe	.....	D28/63 X

Primary Examiner—Brian N. Vinson  
Attorney, Agent, or Firm—Willie Krawitz

### [57] CLAIM

The ornamental design for an assembly of a play ball for containing soap and attached children's wash cloth, as shown and described.

#### DESCRIPTION

FIG. 1 is a top, front, and right side perspective view of an assembly of a play ball for containing soap and attached children's wash cloth showing my new design, the broken-line disclosure of a holder being for illustrative purposes only and forming no part of the claimed design;

FIG. 2 is a front elevational view thereof, the rear and side views of the ball portion having the appearance of a conventional baseball;

FIG. 3 is a top plan view thereof;

FIG. 4 is a bottom plan view thereof;

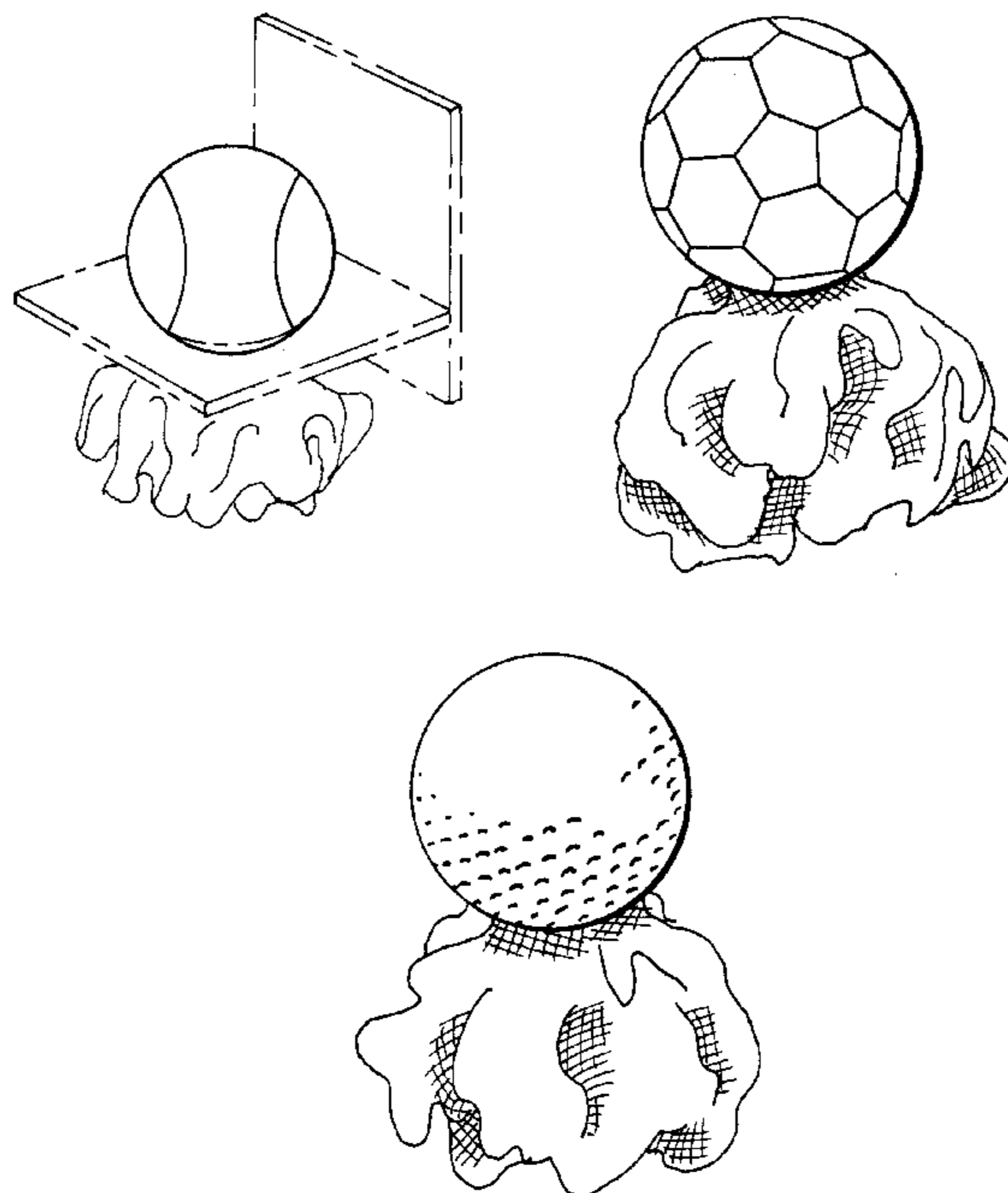
FIG. 5 is a front elevational view of a second embodiment thereof, the only difference in appearance from the other embodiments residing in the appearance of the ball portion, with the rear and side views of the ball portion having the appearance of a conventional soccer ball;

FIG. 6 is a front elevational view of a third embodiment thereof, the only difference in appearance from the other embodiments residing in the appearance of the ball portion, with the rear and side views of the ball portion having the appearance of a conventional golf ball;

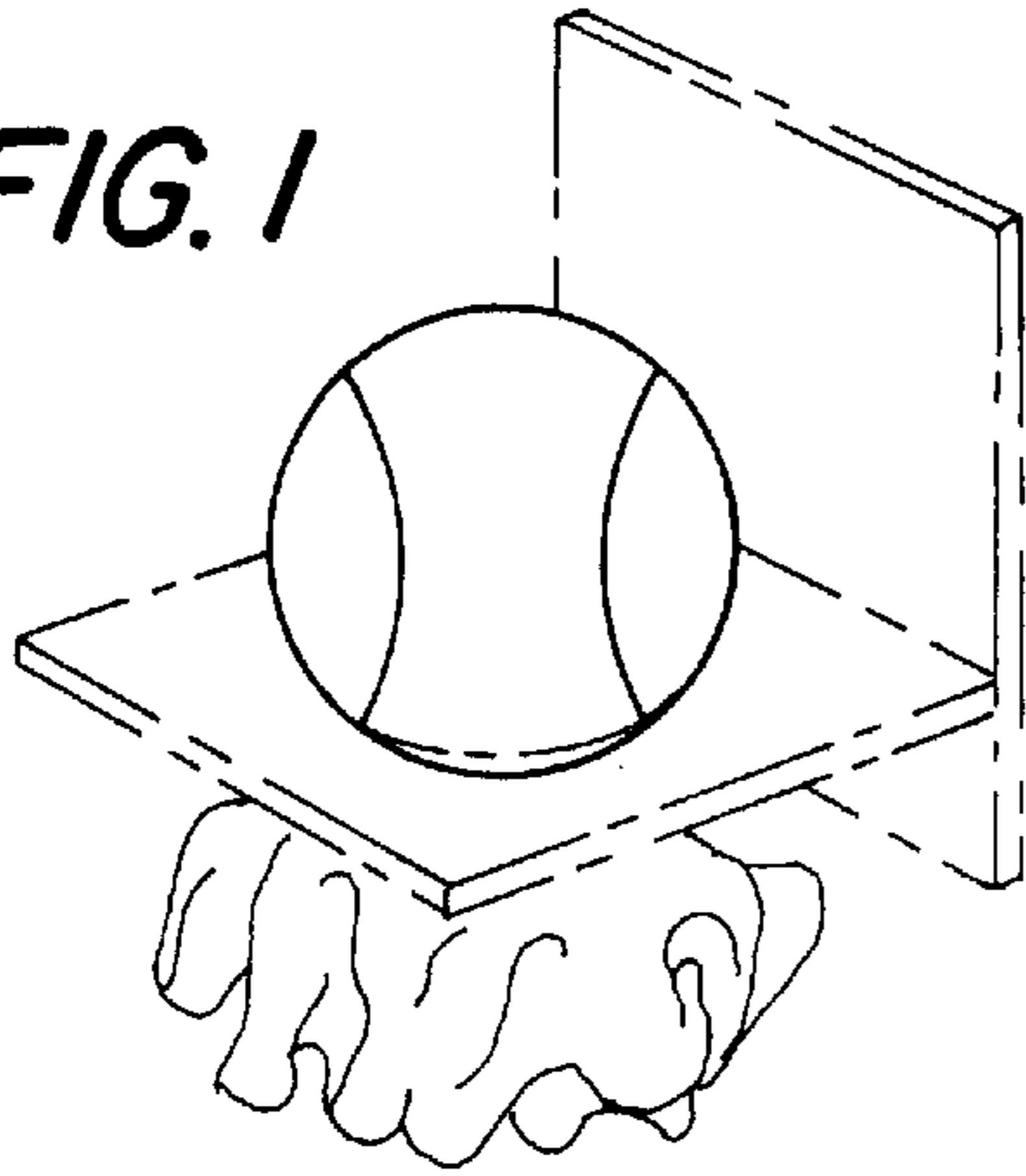
FIG. 7 is a front elevational view of a fourth embodiment thereof, the only difference in appearance from the other embodiments residing in the appearance of the ball portion, with the rear and side views of the ball portion having the appearance of a conventional basketball; and,

FIG. 8 is a front elevational view of a fifth embodiment thereof, the only difference in appearance from the other embodiments residing in the appearance of the ball portion, with the rear and side views of the ball portion having the appearance of a conventional football.

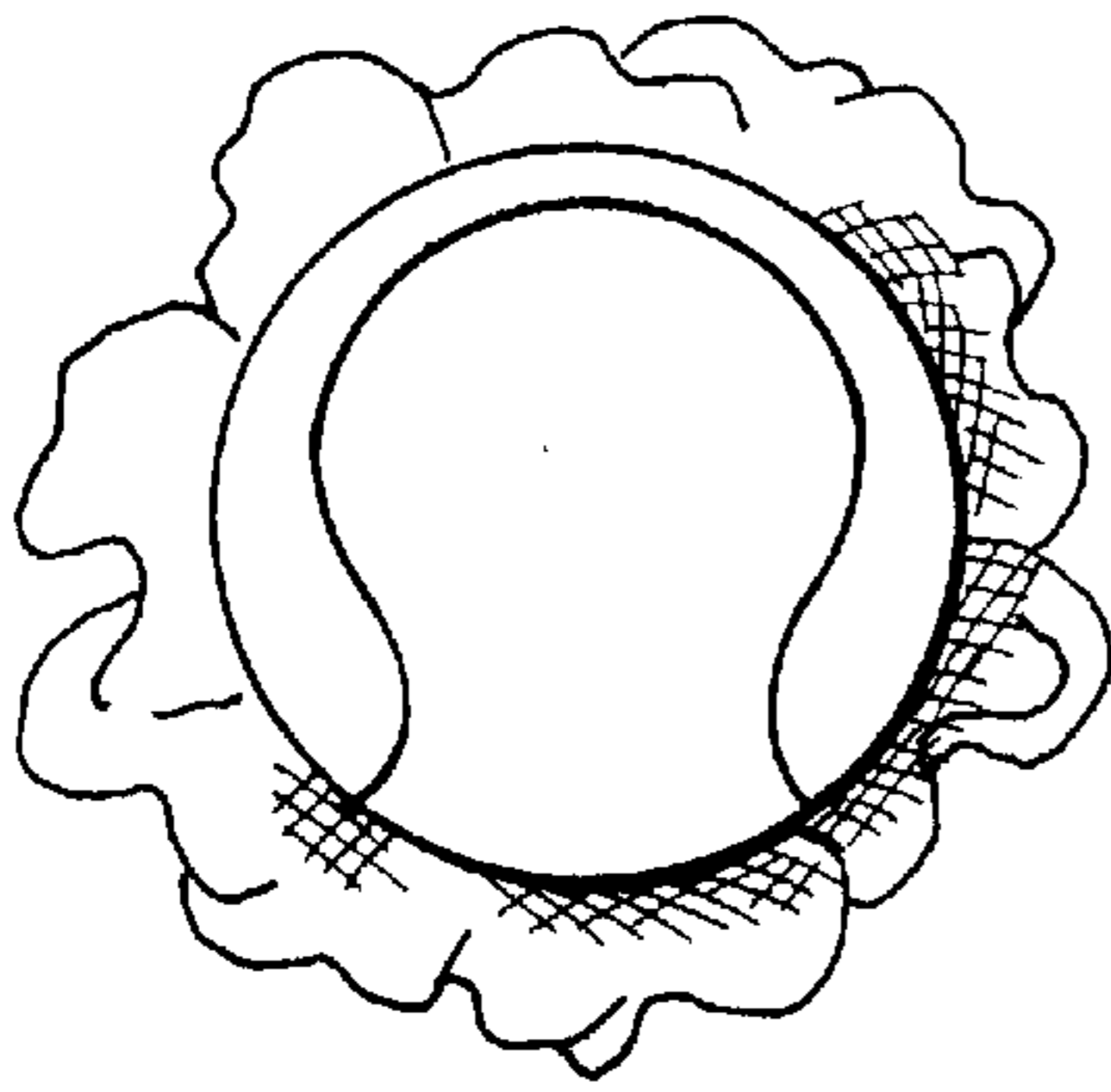
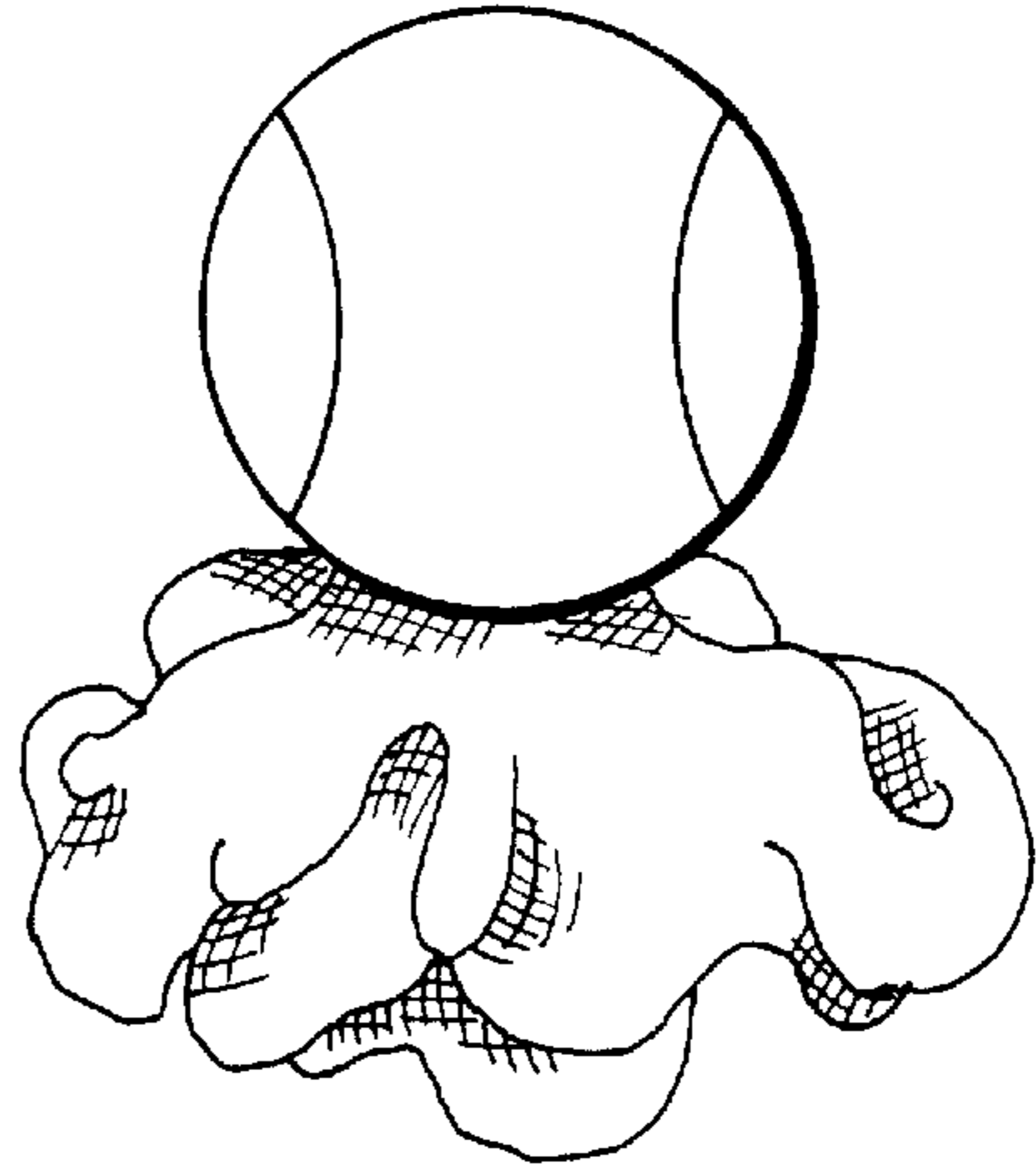
1 Claim, 2 Drawing Sheets



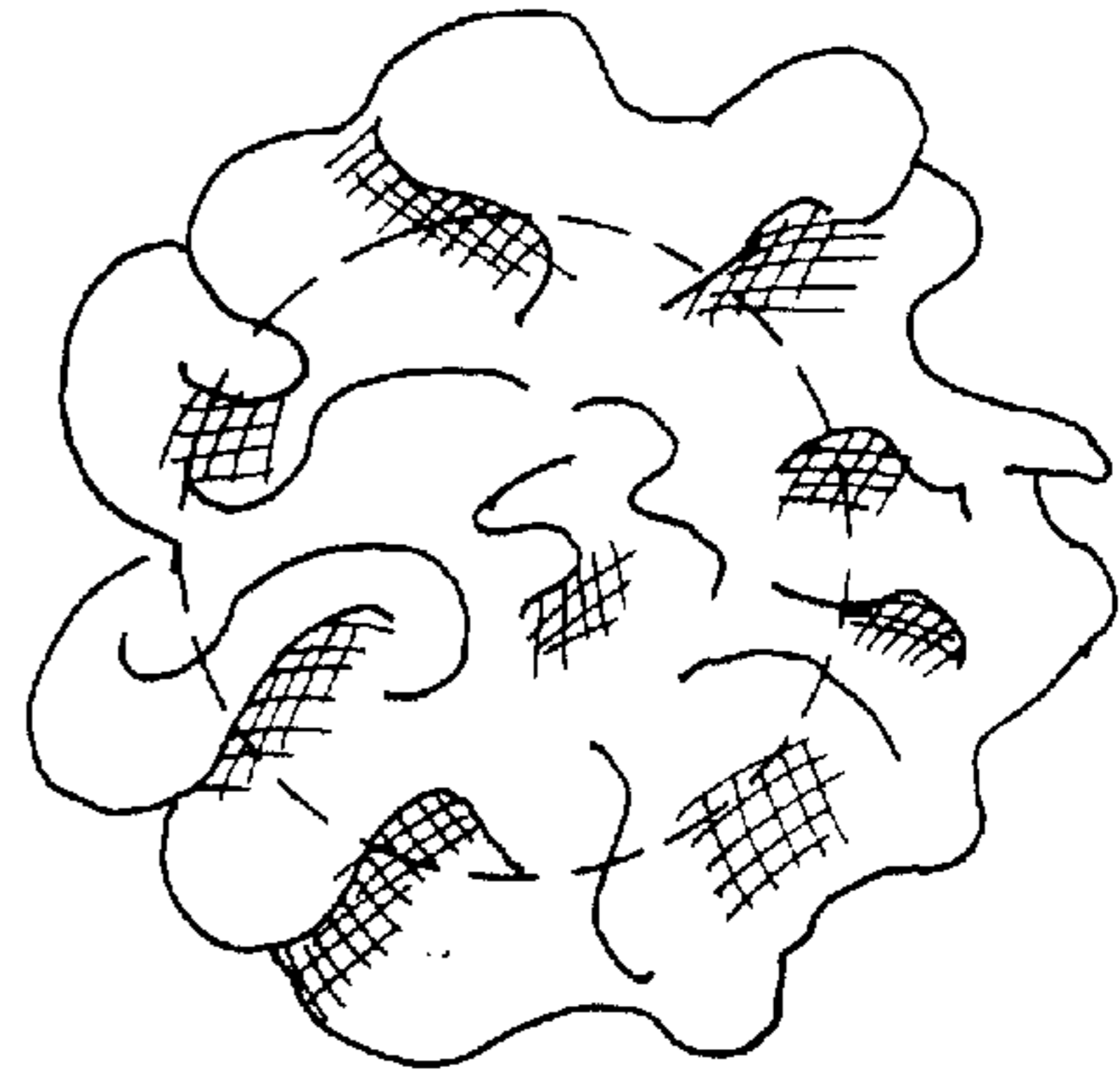
**FIG. 1**



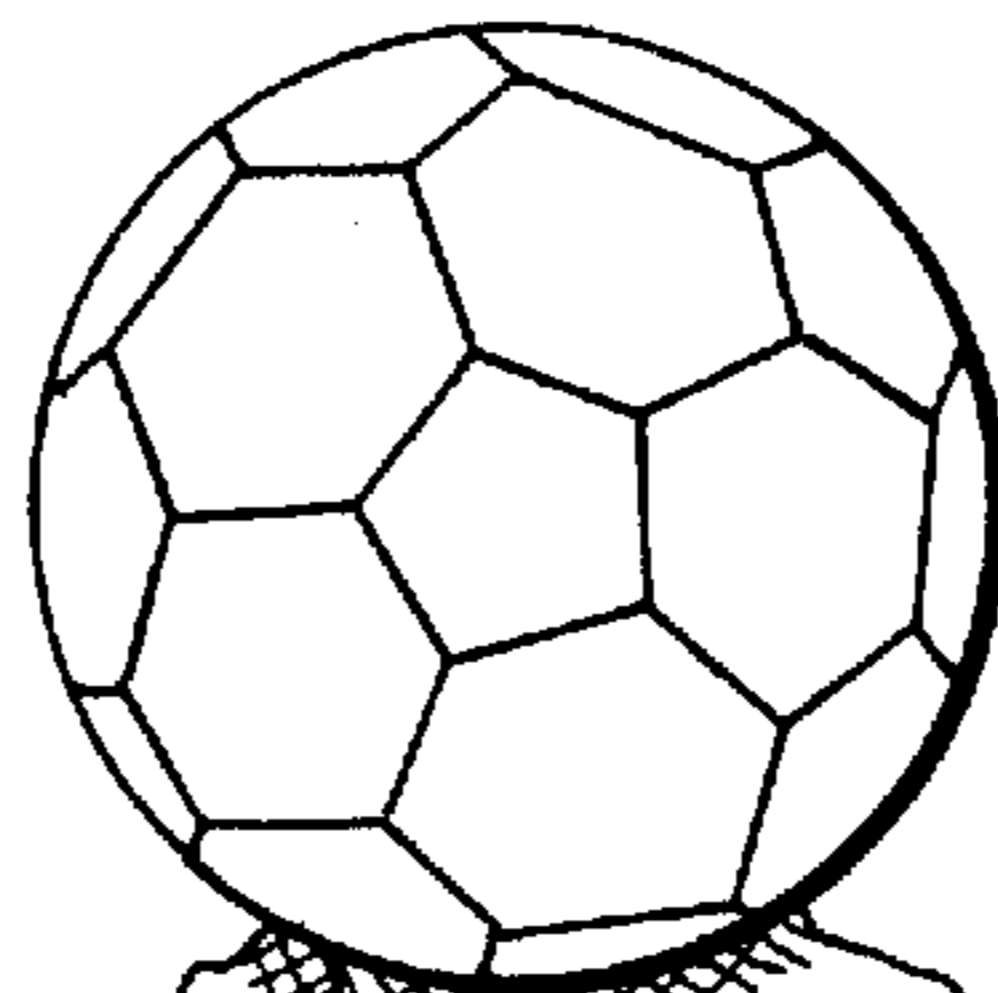
**FIG. 2**



**FIG. 3**

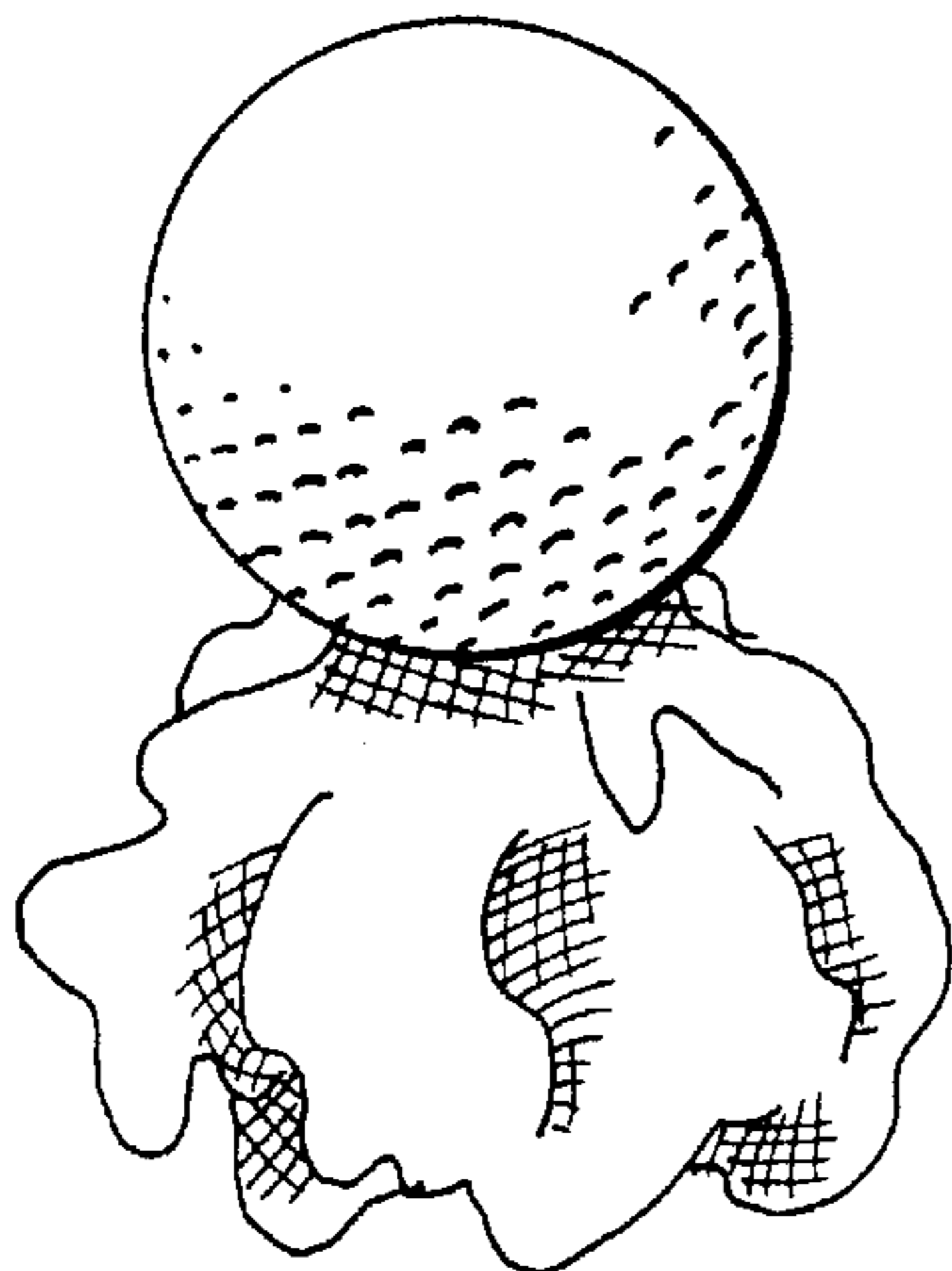


**FIG. 4**

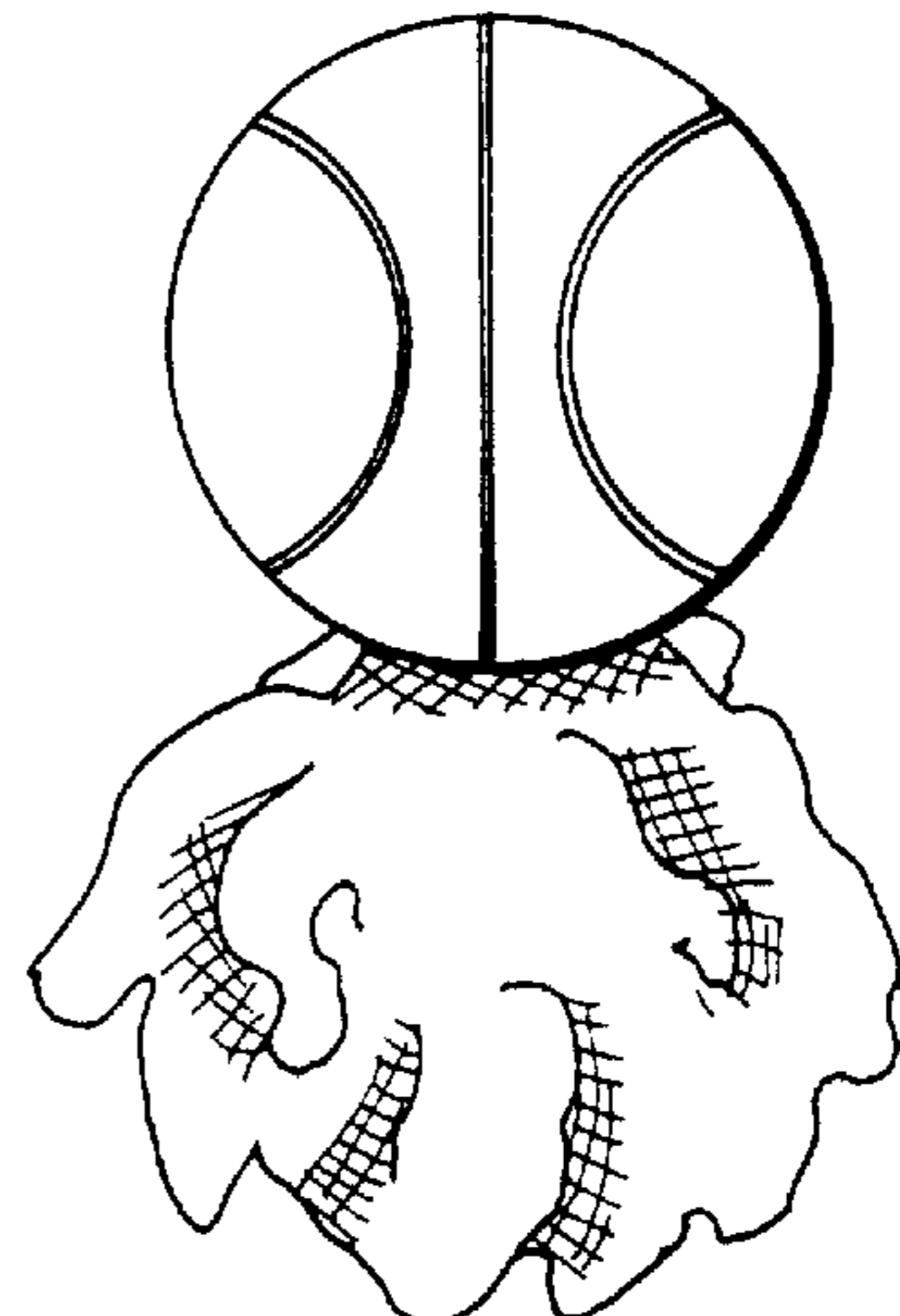


**FIG. 5**

**FIG. 6**



**FIG. 7**



*FIG. 8*

