



US00D405864S

United States Patent [19] Gallagher

[11] **Patent Number: Des. 405,864**

[45] **Date of Patent: **Feb. 16, 1999**

[54] **FISHING LURE**

[76] **Inventor: Gerald T. Gallagher, 6383 Quillan St., San Diego, Calif. 92111**

[**] **Term: 14 Years**

[21] **Appl. No.: 70,451**

[22] **Filed: May 8, 1997**

[51] **LOC (6) Cl. 02-04**

[52] **U.S. Cl. D22/133; D22/126**

[58] **Field of Search D22/126, 132, D22/133; 43/42.35, 42.49, 42.45, 42.09, 42.06, 42.1**

[56] **References Cited**

U.S. PATENT DOCUMENTS

D. 161,992	2/1951	Amato	D22/126
D. 317,038	5/1991	Mann	D22/126
D. 350,382	9/1994	Mann	D22/133

D. 377,384	1/1997	Hill	D22/133
2,225,676	12/1940	White	D22/126
3,293,791	12/1966	Hinkson	43/42.49
3,408,764	11/1968	McCurry	D22/132
4,054,004	10/1977	Schott	43/42.1

Primary Examiner—Doris V. Coles

[57] **CLAIM**

I claim the ornamental design for a fishing lure, as shown.

DESCRIPTION

FIG. 1 is a perspective view of a fishing lure, showing my new design;
 FIG. 2 is a front elevational view thereof;
 FIG. 3 is a rear elevational view thereof;
 FIG. 4 is a right side elevational view thereof;
 FIG. 5 is a top plan view thereof; and,
 FIG. 6 is a bottom plan view thereof.

1 Claim, 3 Drawing Sheets

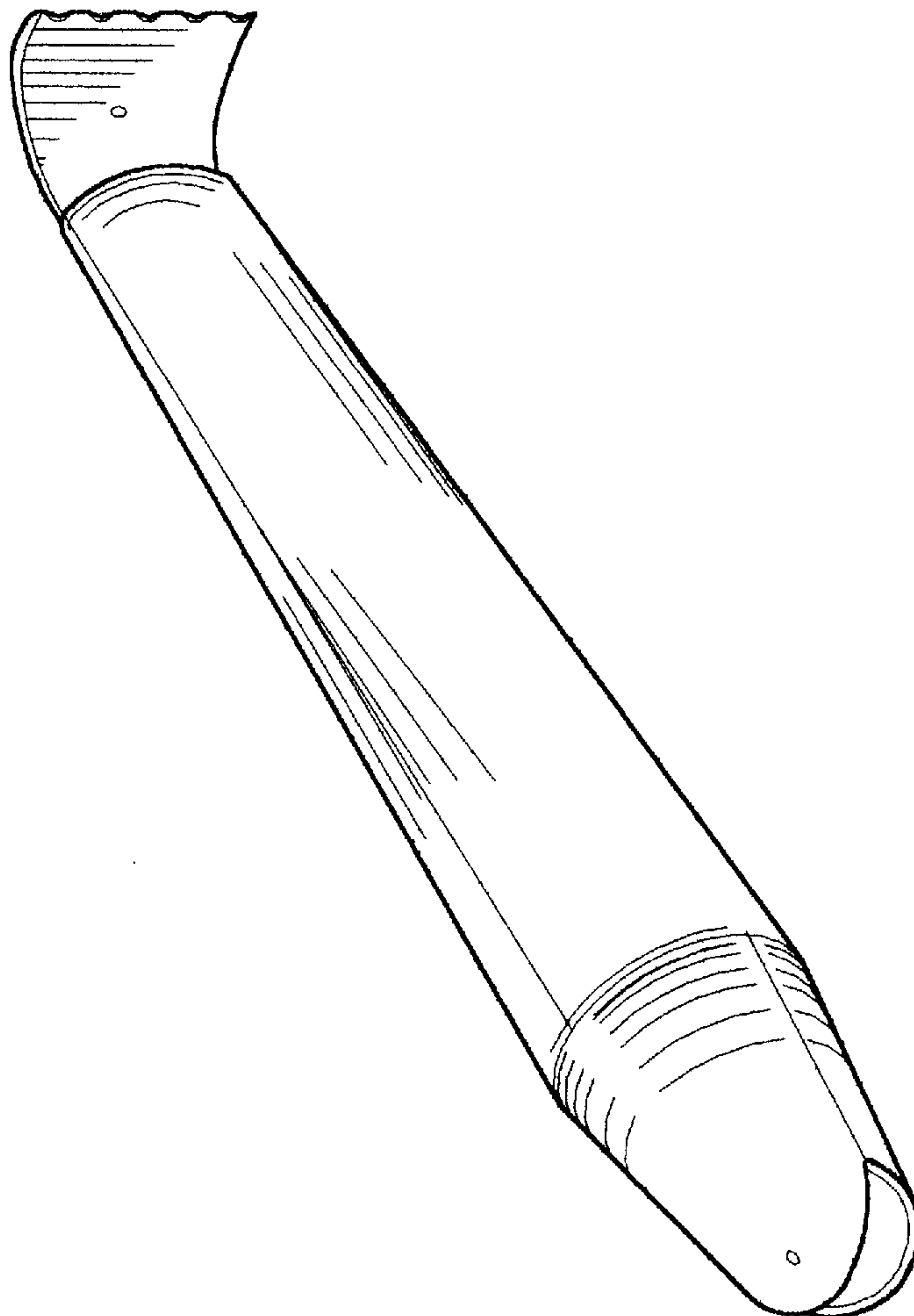

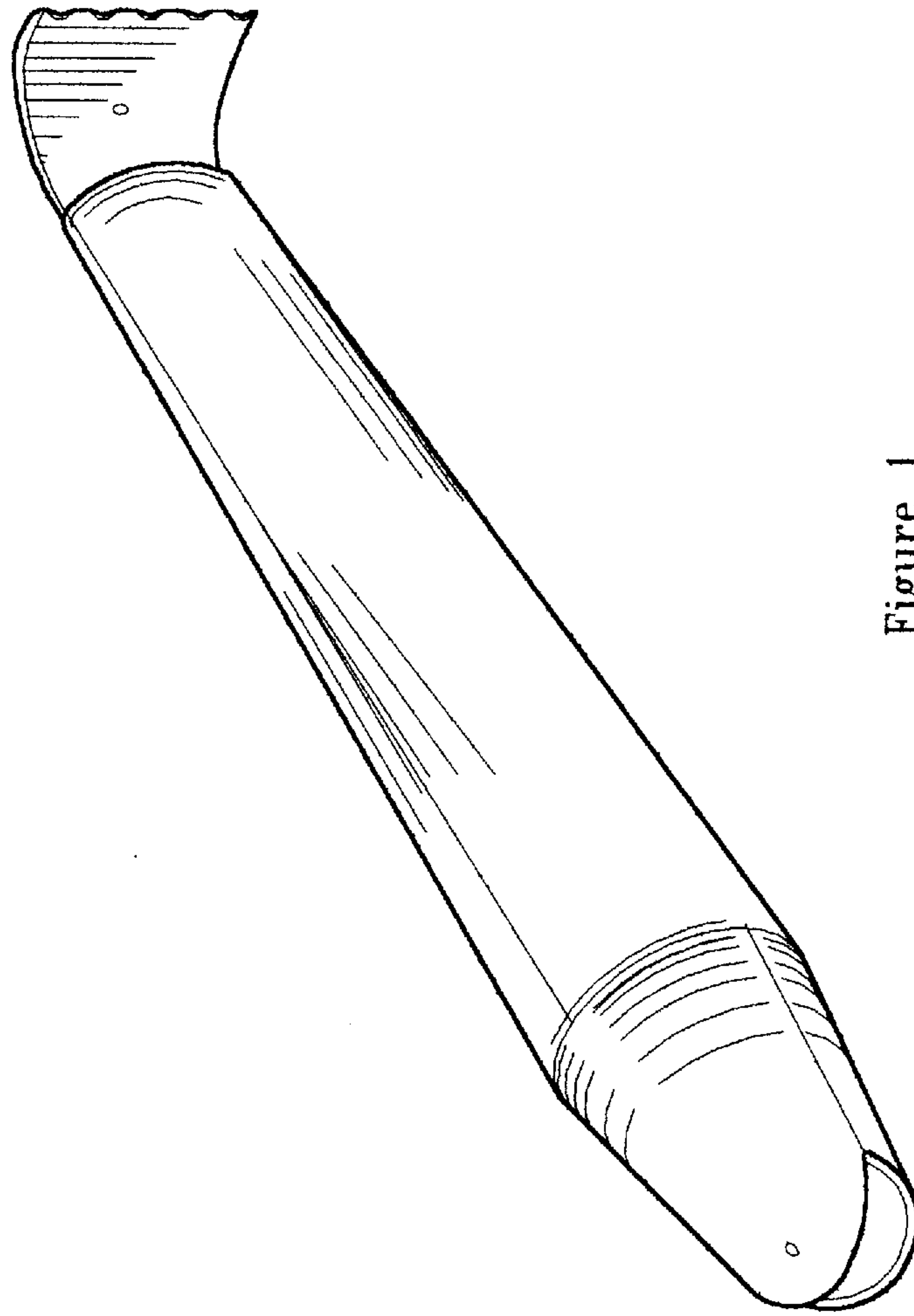

Figure 1

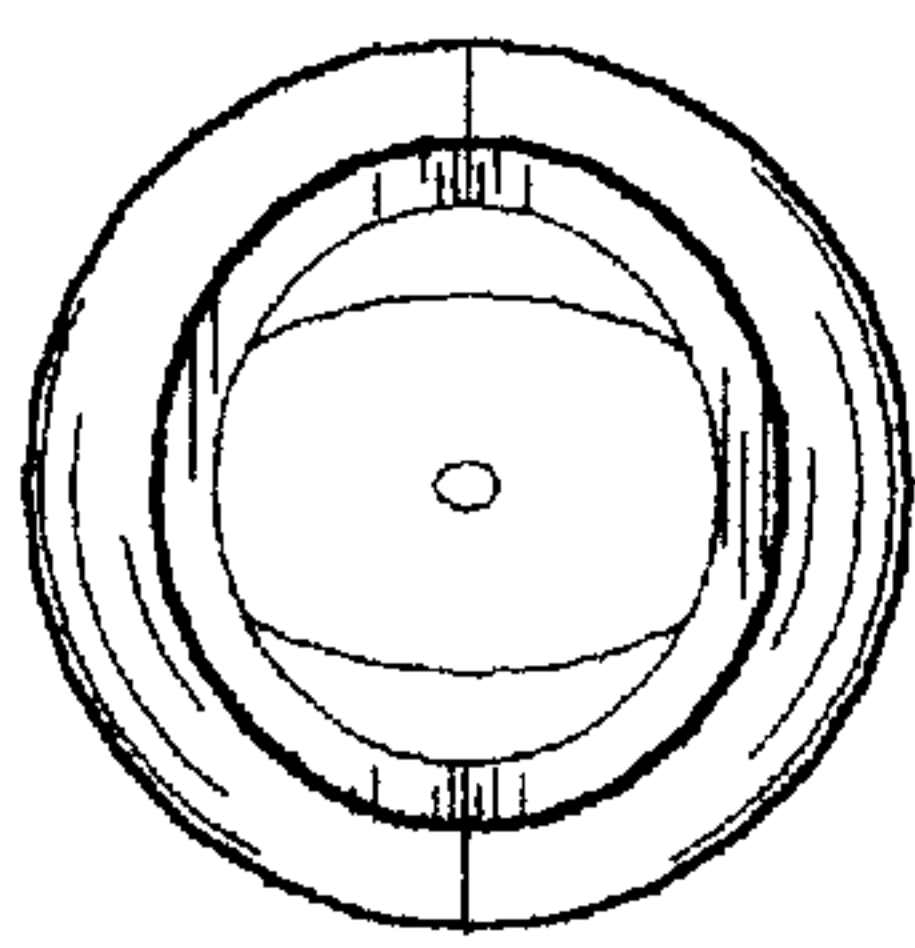

Figure 2

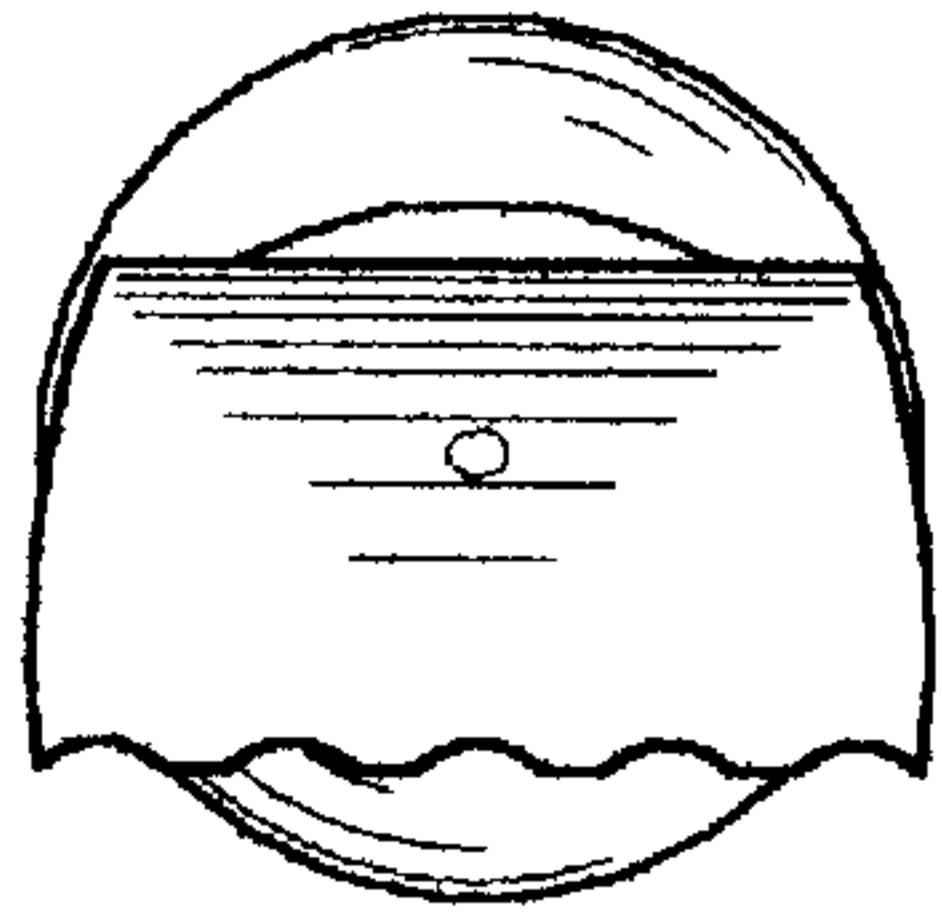

Figure 3

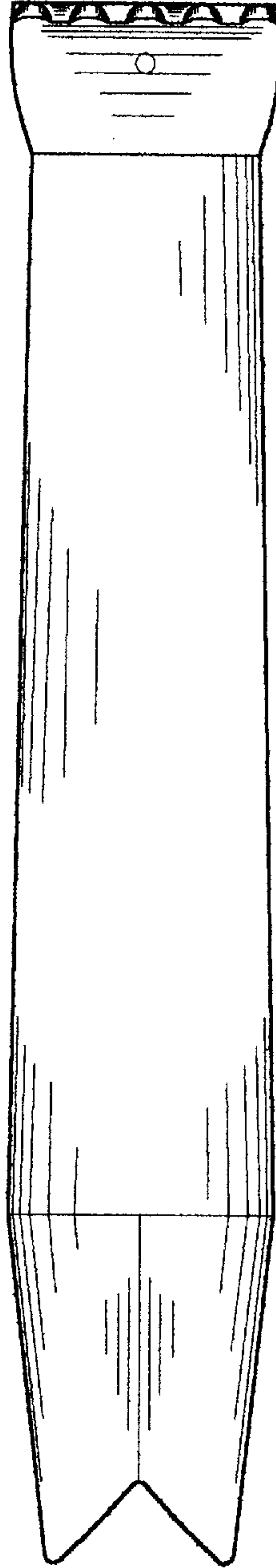

Figure 4

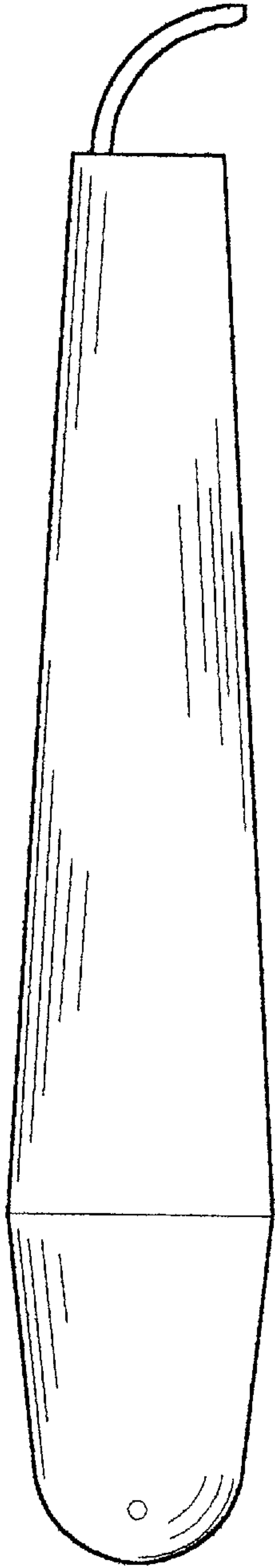

Figure 5

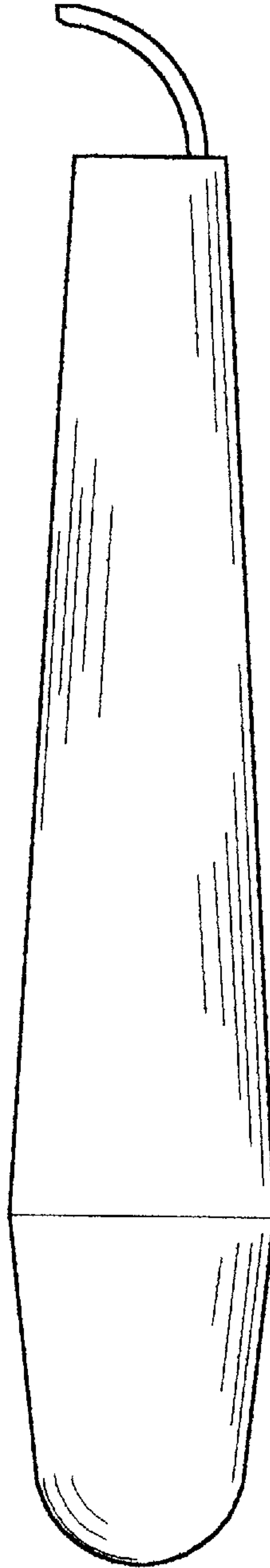

Figure 6