



US00D405757S

United States Patent [19] Chiu

[11] **Patent Number: Des. 405,757**

[45] **Date of Patent: **Feb. 16, 1999**

[54] **ELECTRICAL CONNECTOR**

D. 374,862 10/1996 Lee D13/133

[76] Inventor: **Irene Chiu**, 6F-3, No. 106, Ming-Feng St., Hsi-Chih Chen, Taipei Hsien, Taiwan

Primary Examiner—Joel Sincavage
Attorney, Agent, or Firm—Christensen O'Connor Johnson & Kindness PLLC

[**] Term: **14 Years**

[57] CLAIM

[21] Appl. No.: **87,639**

The ornamental design for electrical connector, as shown and described.

[22] Filed: **May 6, 1998**

DESCRIPTION

[51] **LOC (6) Cl.** **13-03**

[52] **U.S. Cl.** **D13/133**

[58] **Field of Search** D13/133; 439/843, 439/851, 675

FIG. 1 is a perspective view of electrical connector showing my new design. The broken lines in FIG. 1 illustrate a housing for the connector which is environmental structure that forms no part of the claimed design; FIG. 2 is a front elevational view thereof; FIG. 3 is a rear elevational view thereof; FIG. 4 is a left side elevational view thereof; FIG. 5 is a right side elevational view thereof; FIG. 6 is a top plan view thereof; and, FIG. 7 is a bottom plan view thereof.

[56] References Cited

U.S. PATENT DOCUMENTS

D. 251,781	5/1979	Hutton	D13/133
D. 323,643	2/1992	Lee	D13/133
D. 325,023	3/1992	Lee et al.	D13/133
D. 366,864	2/1996	Lee	D13/133

1 Claim, 3 Drawing Sheets

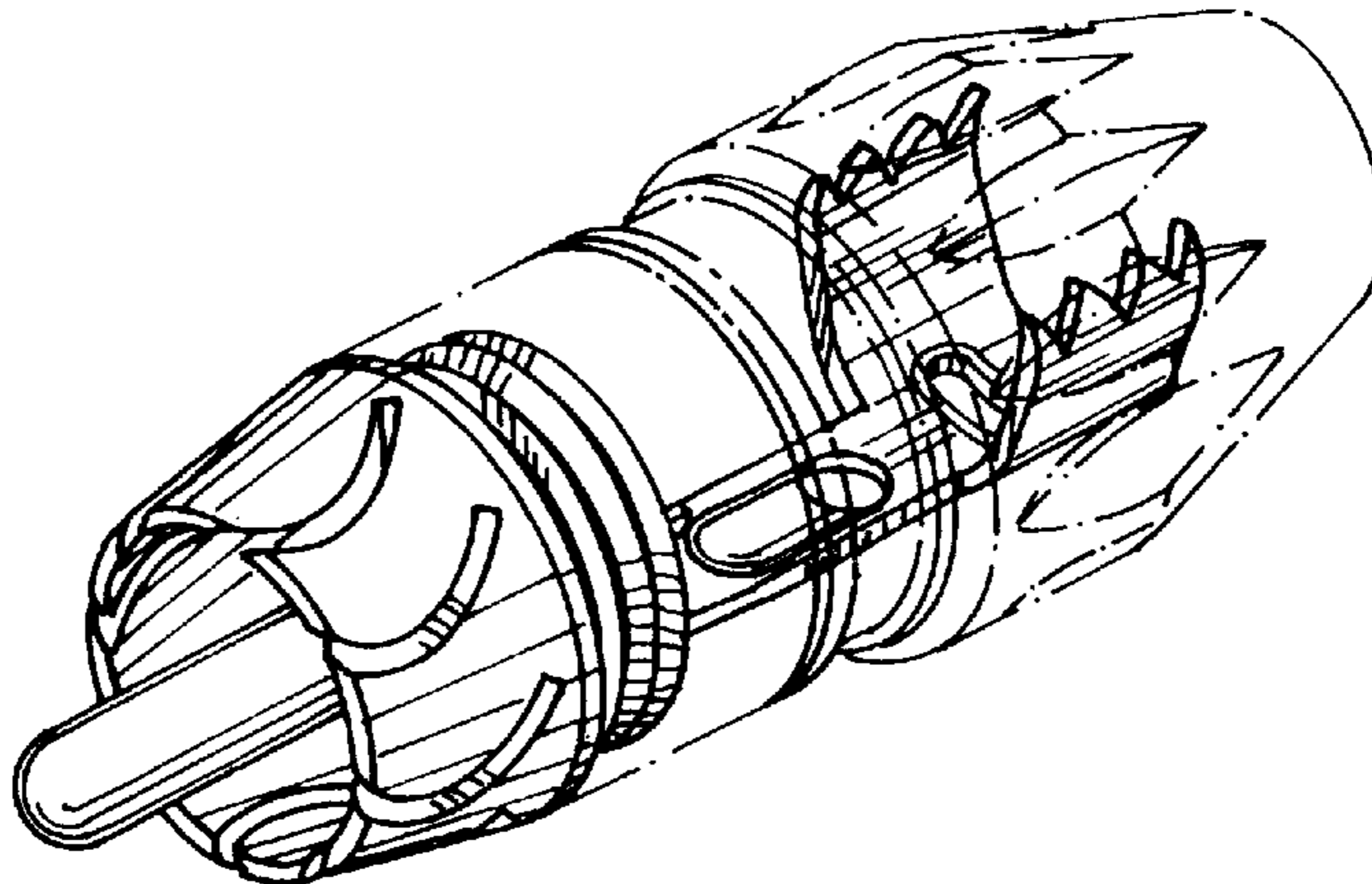

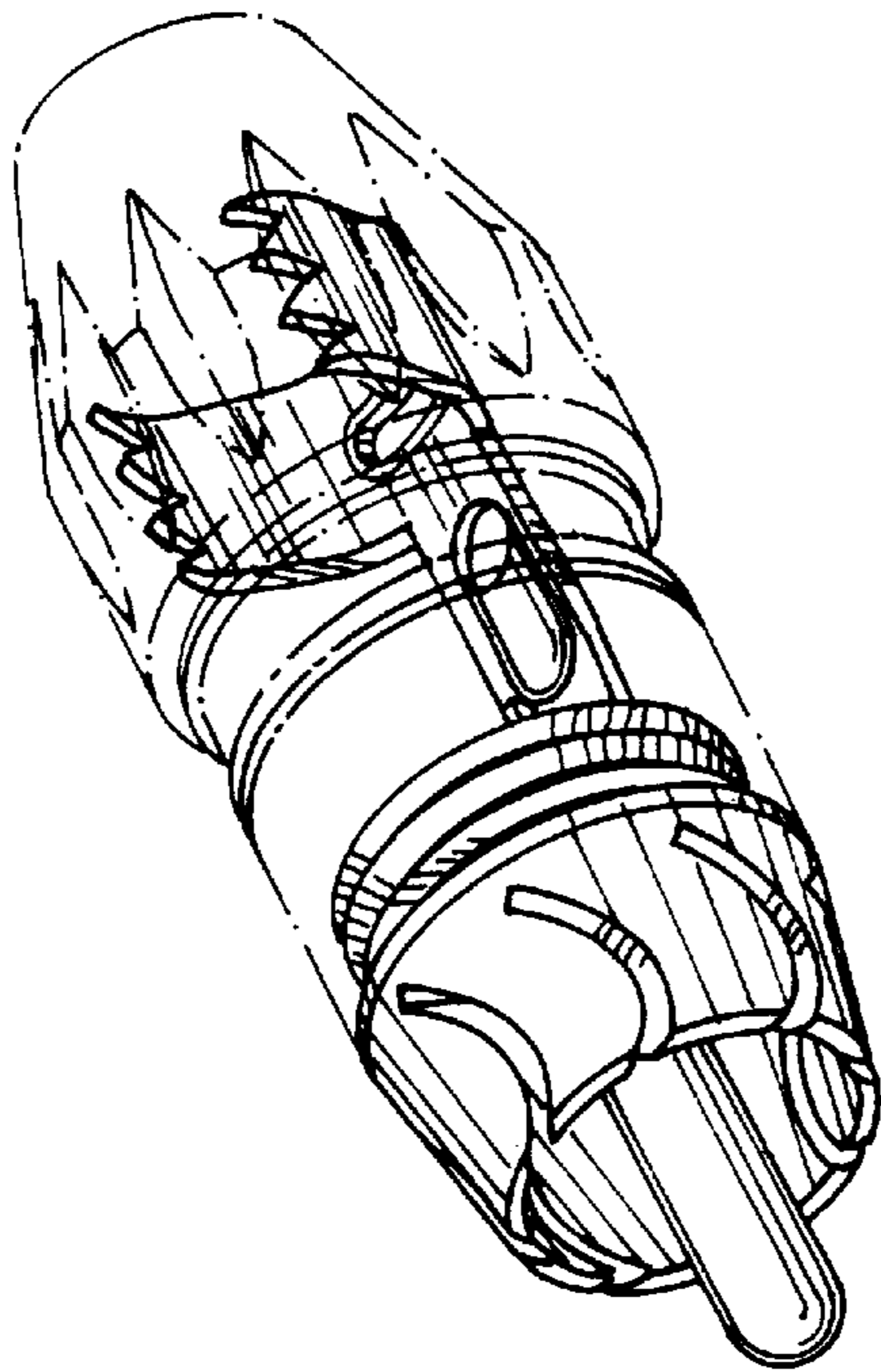

FIG.1

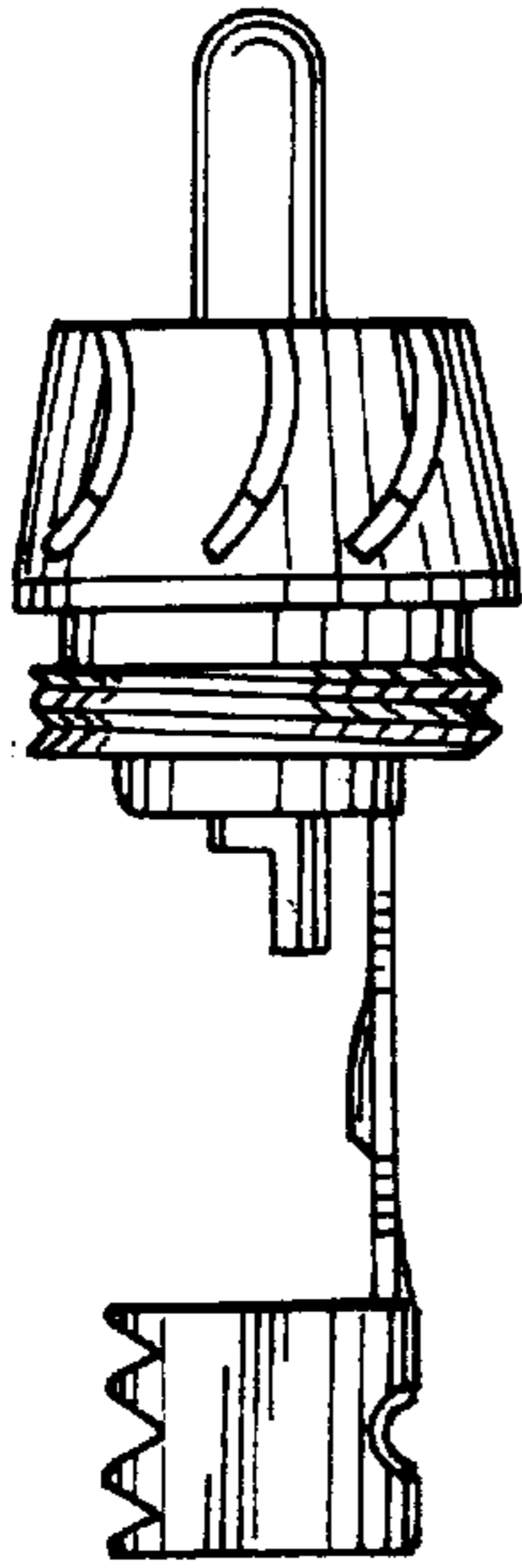

FIG. 4

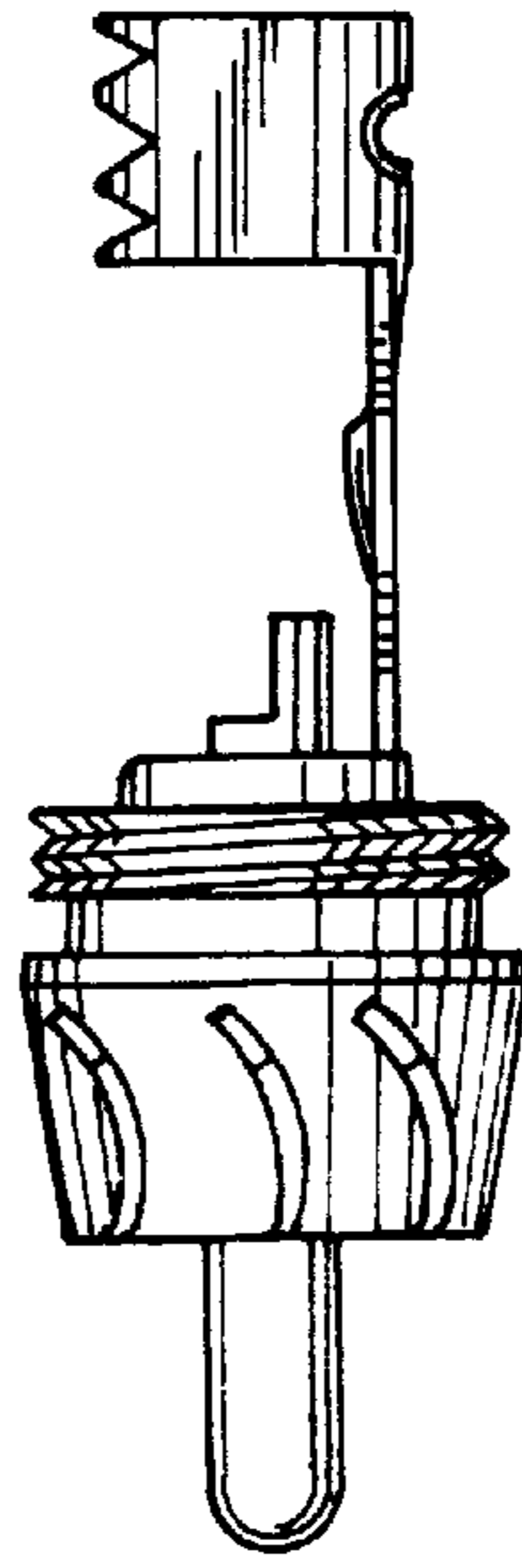

FIG. 5



FIG. 2

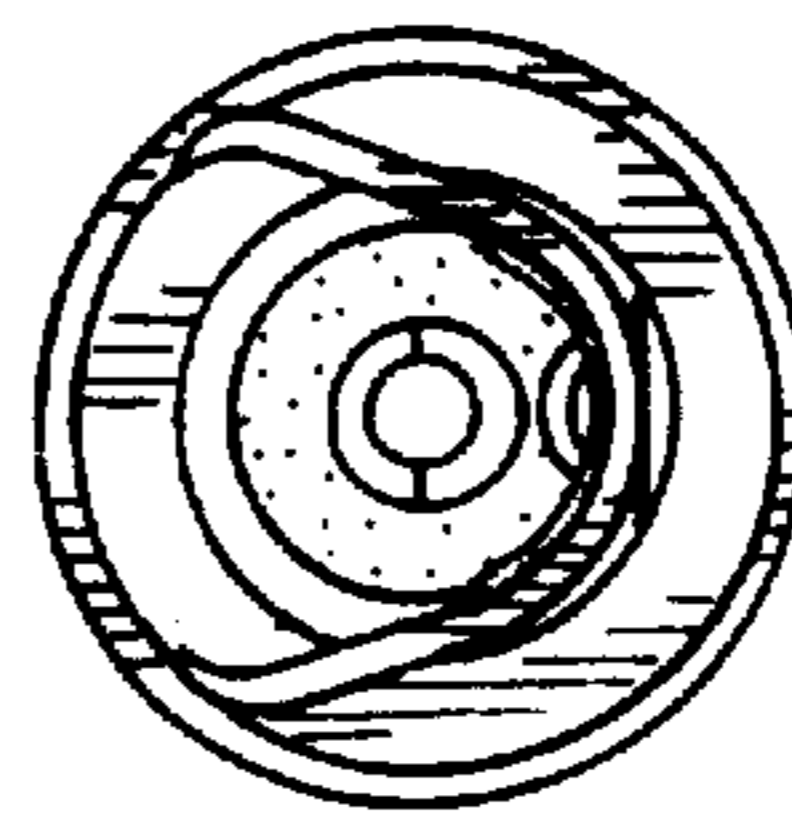

FIG. 3

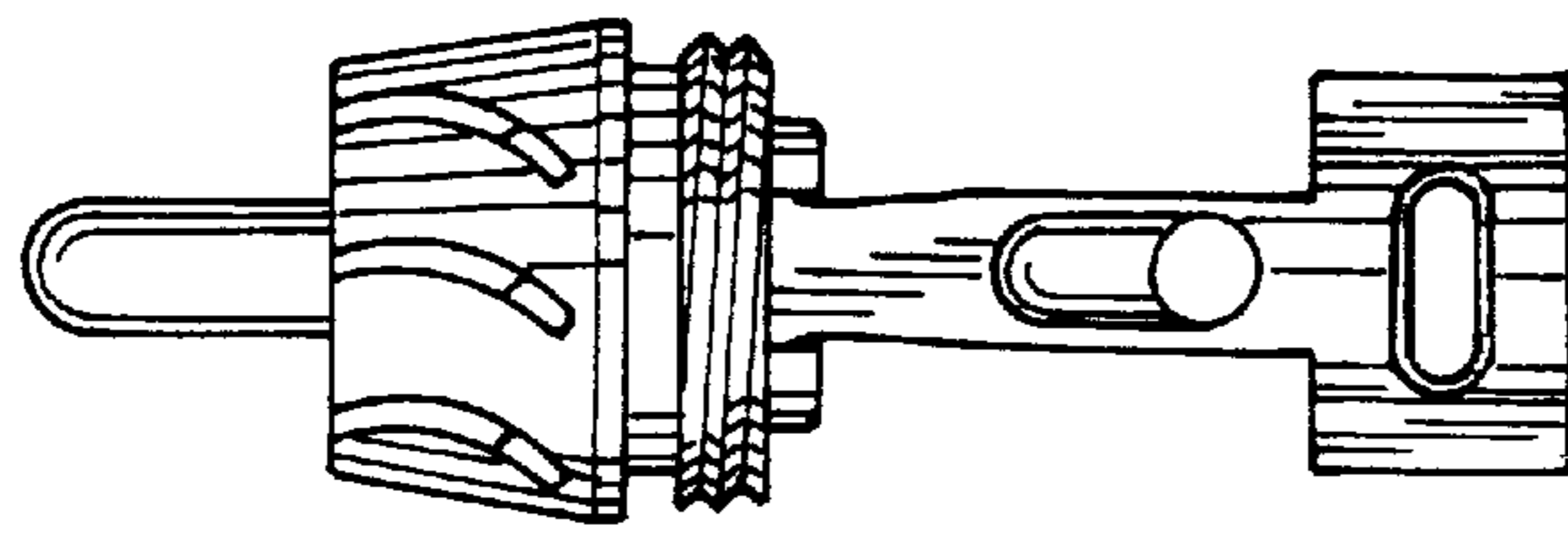

FIG. 7

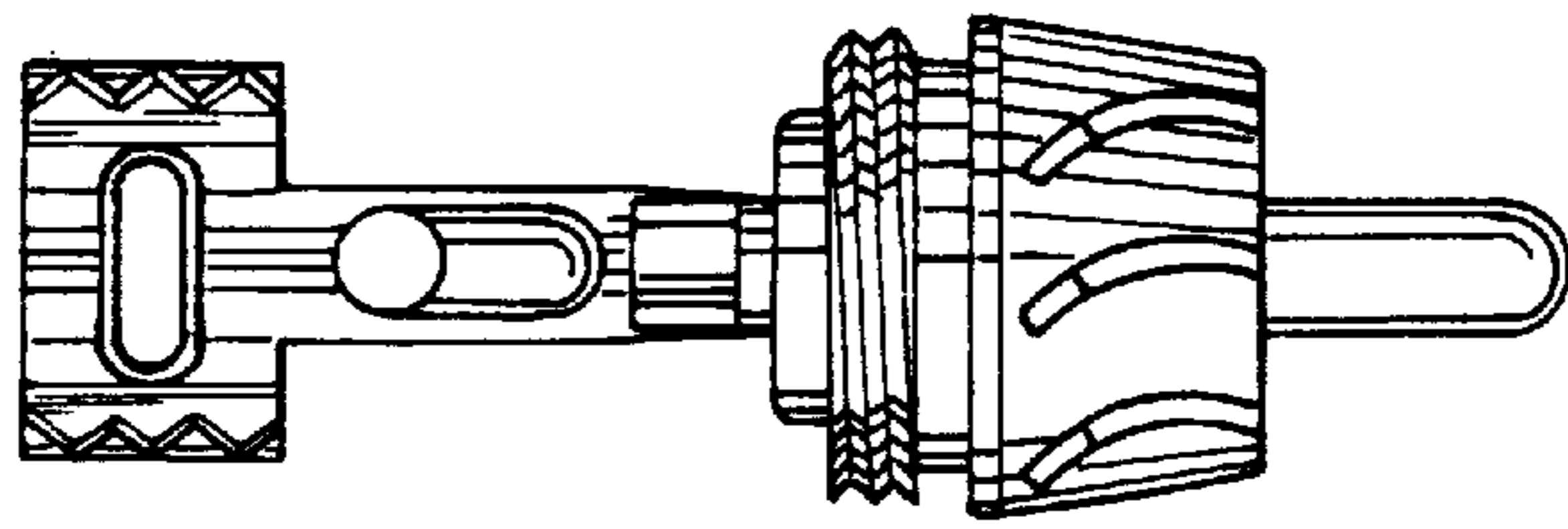

FIG. 6