



US00D405721S

# United States Patent [19]

[11] Patent Number: Des. 405,721

Dennis

[45] Date of Patent: \*\*Feb. 16, 1999

## [54] FOOTBALL MEMORABILIA

## DESCRIPTION

[76] Inventor: Timothy A. Dennis, 2240 Lake Daisy Rd., Winter Haven, Fla. 33884

FIG. 1 is a side, front perspective view of a football memorabilia showing my new design;

[\*\*] Term: 14 Years

FIG. 2 is a front view thereof;

[21] Appl. No.: 86,801

FIG. 3 is a left side view thereof;

[22] Filed: Apr. 2, 1998

FIG. 4 is a rear view thereof;

[51] LOC (6) Cl. .... 11-02

FIG. 5 is a right side view thereof;

[52] U.S. Cl. .... D11/157

FIG. 6 is a top plan view thereof;

[58] Field of Search ..... D11/117, 131,  
D11/157; 428/542.2, 542.4

FIG. 7 is a bottom plan view thereof;

FIG. 8 is a side, front perspective view of a second embodiment of a football memorabilia;

## [56] References Cited

### U.S. PATENT DOCUMENTS

D. 226,091	1/1973	Brack	.....	D11/157
D. 258,125	2/1981	Bailey	.....	D11/157
D. 298,105	10/1988	Lamantia, Jr.	.....	D11/157 X
D. 319,008	8/1991	Leon	.....	D11/157 X
D. 387,304	12/1997	Alcala	.....	D11/157
D. 389,734	1/1998	Schultz et al.	.....	D11/157 X
D. 391,155	2/1998	Edosn et al.	.....	D11/157 X

FIG. 9 is a front view thereof;

FIG. 10 is a left side view thereof;

FIG. 11 is a rear view thereof;

FIG. 12 is a right side view thereof;

FIG. 13 is a top plan view thereof;

FIG. 14 is a bottom plan view thereof;

FIG. 15 is a side, front perspective view of a third embodiment of a football memorabilia;

FIG. 16 is a front view thereof;

FIG. 17 is a left side view thereof;

FIG. 18 is a rear view thereof;

FIG. 19 is a right side view thereof;

FIG. 20 is a top plan view thereof; and,

FIG. 21 is a bottom plan view thereof.

Primary Examiner—Dominic Simone

Attorney, Agent, or Firm—Allen, Dyer, Doppelt, Milbrath & Gilchrist, P.A.

The broken line showing of a helmet and kicking tee is for illustrative purposes only and forms no part of the claimed design.

## [57] CLAIM

The ornamental design for a football memorabilia, as shown and described.

1 Claim, 12 Drawing Sheets

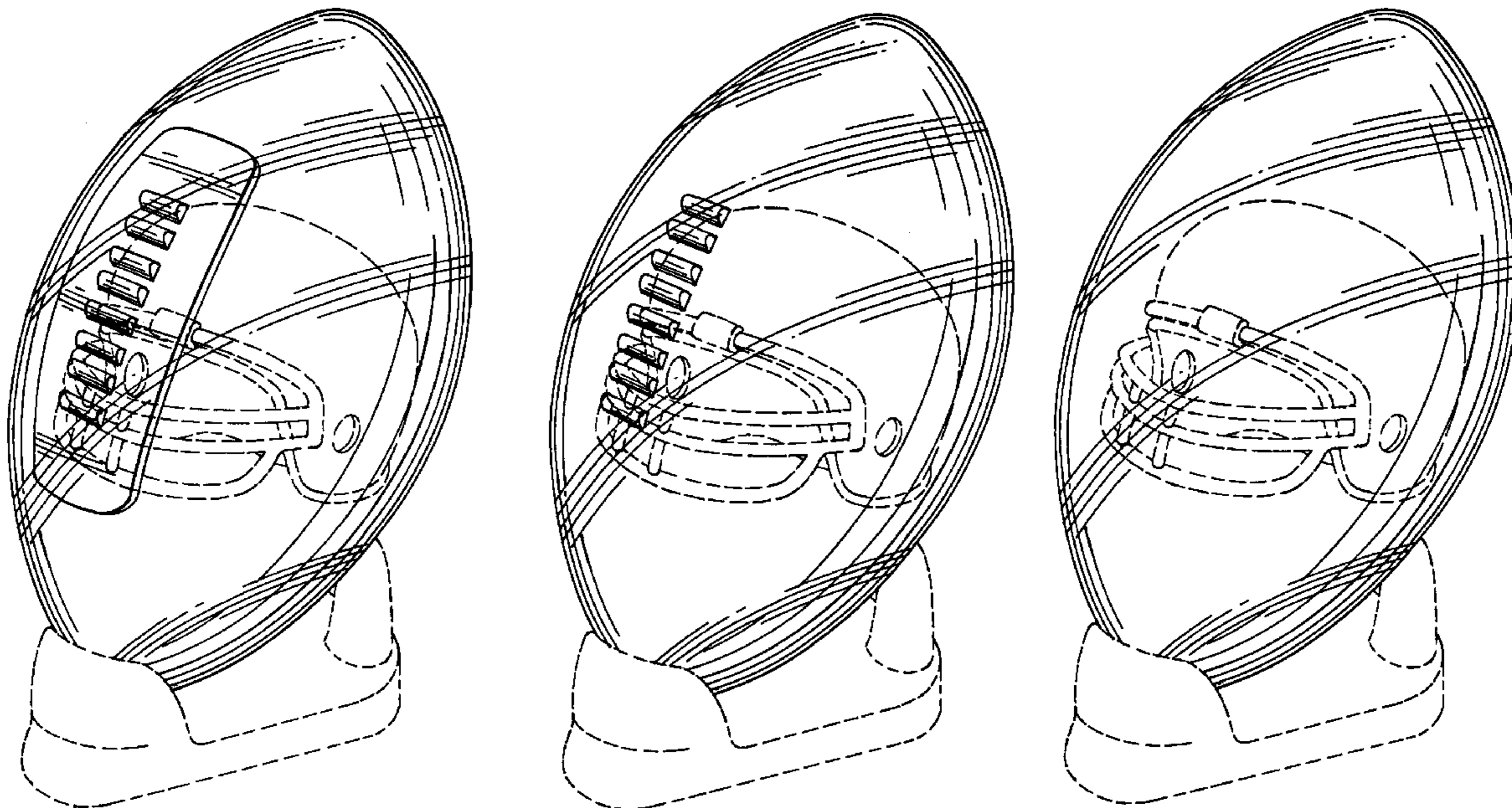

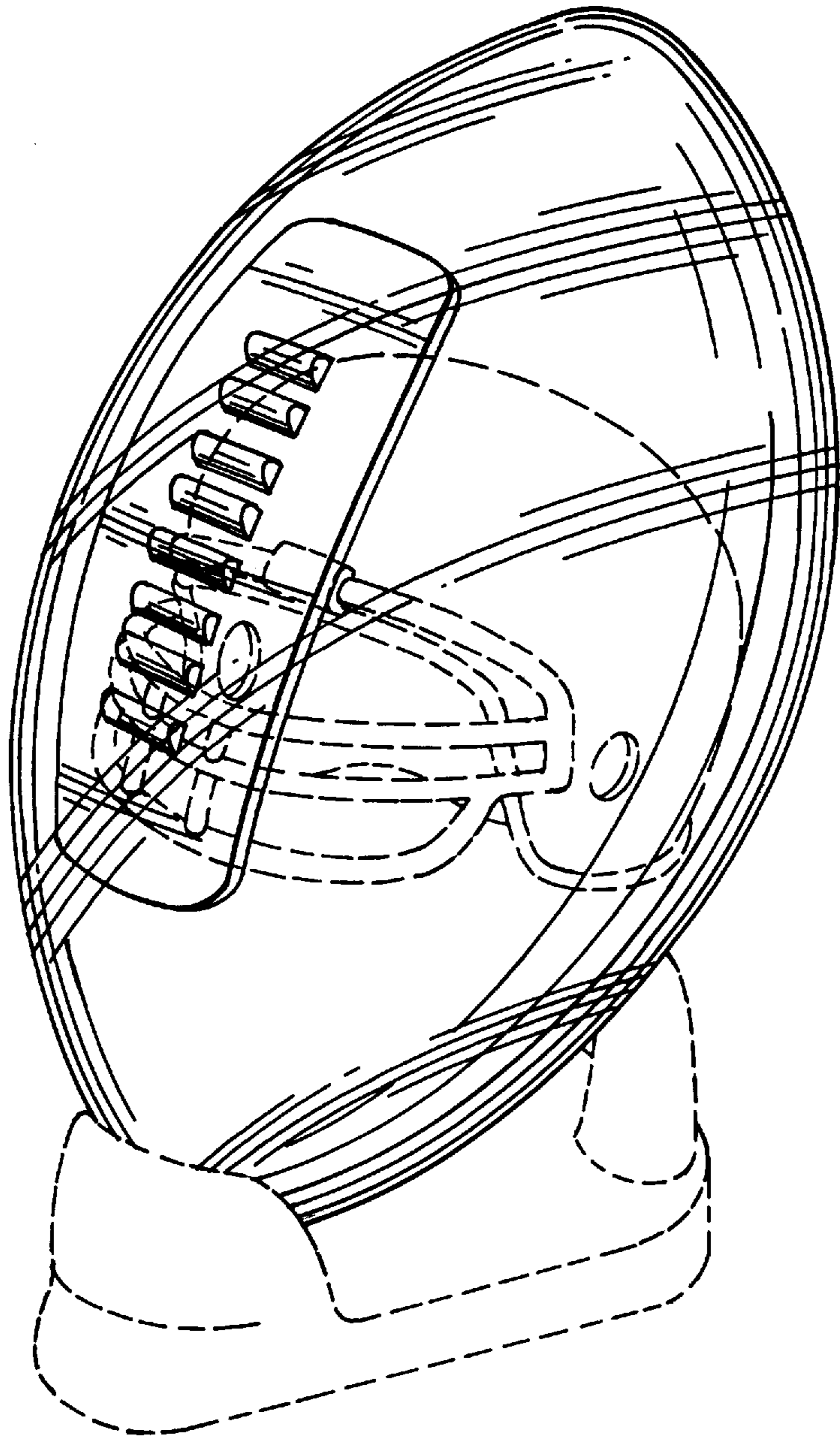

FIG. 1.

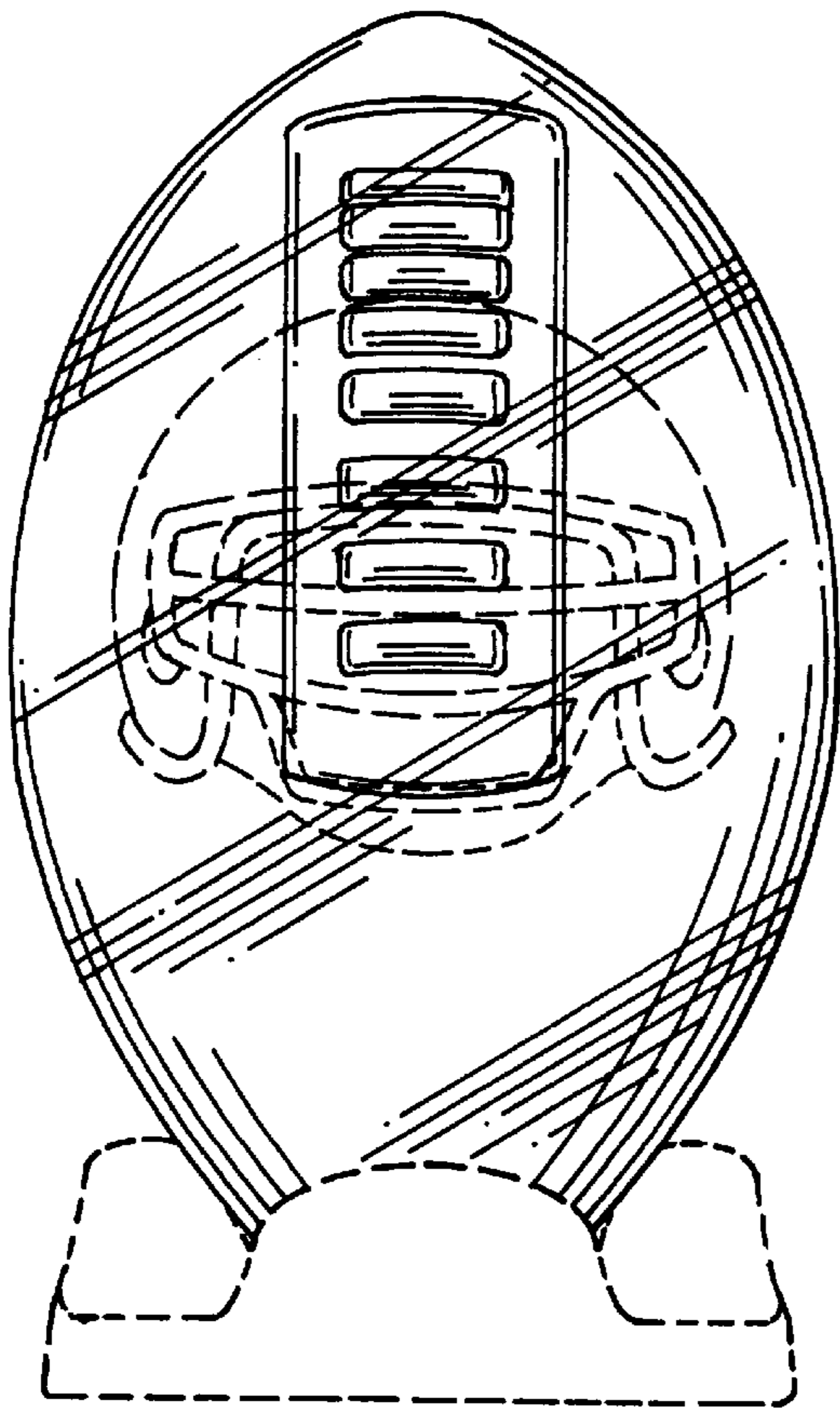

FIG. 2.

FIG. 3.

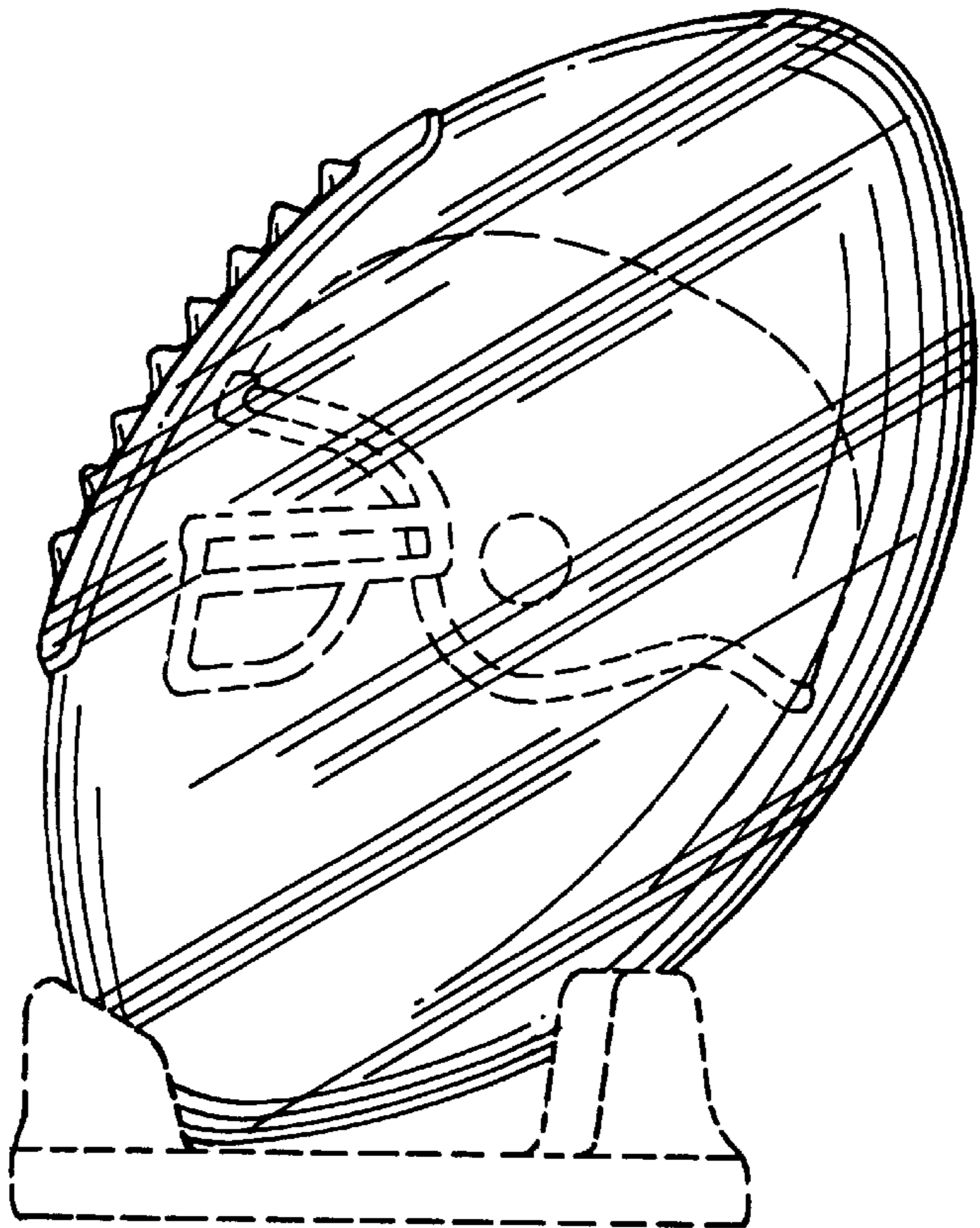

FIG. 4.

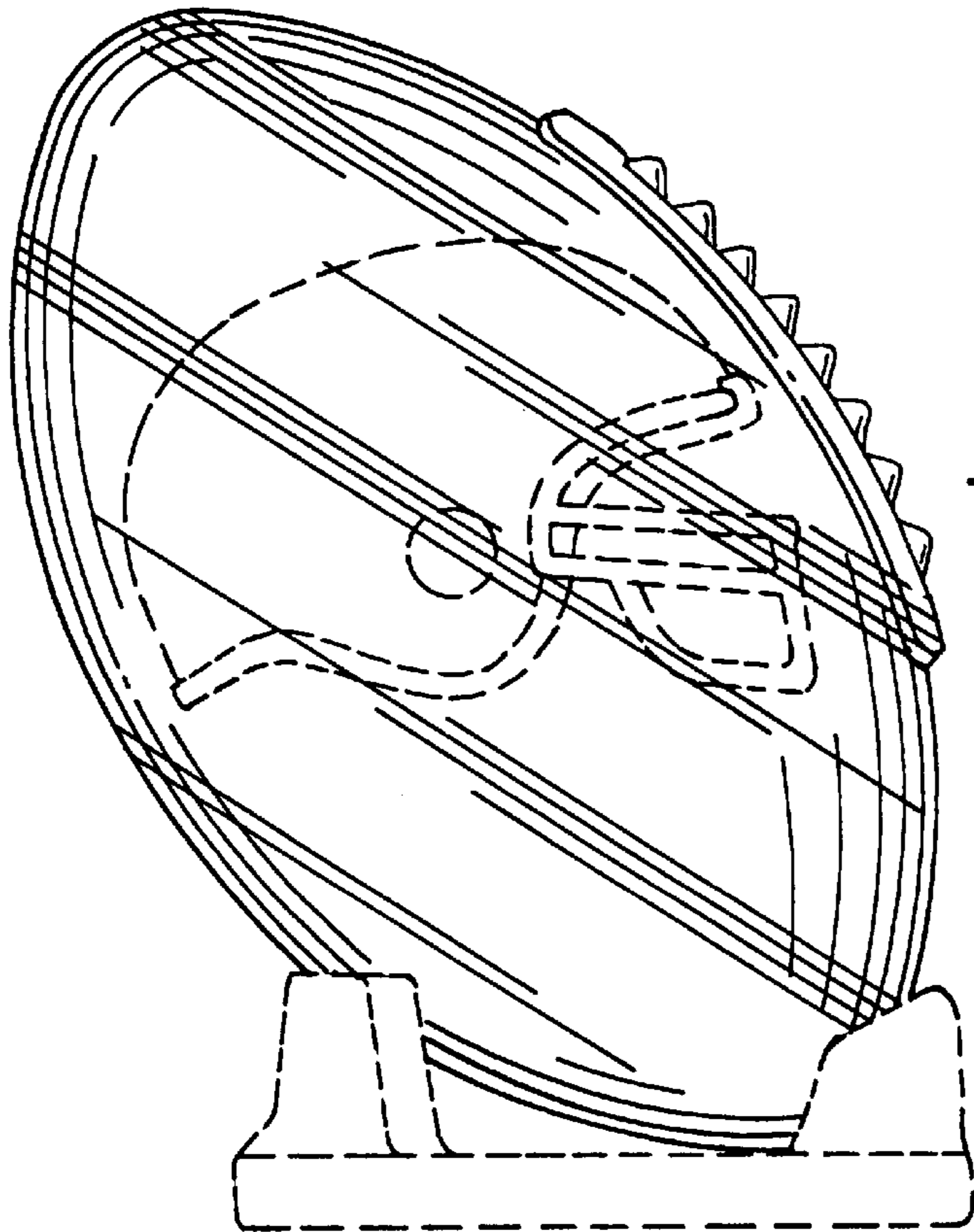
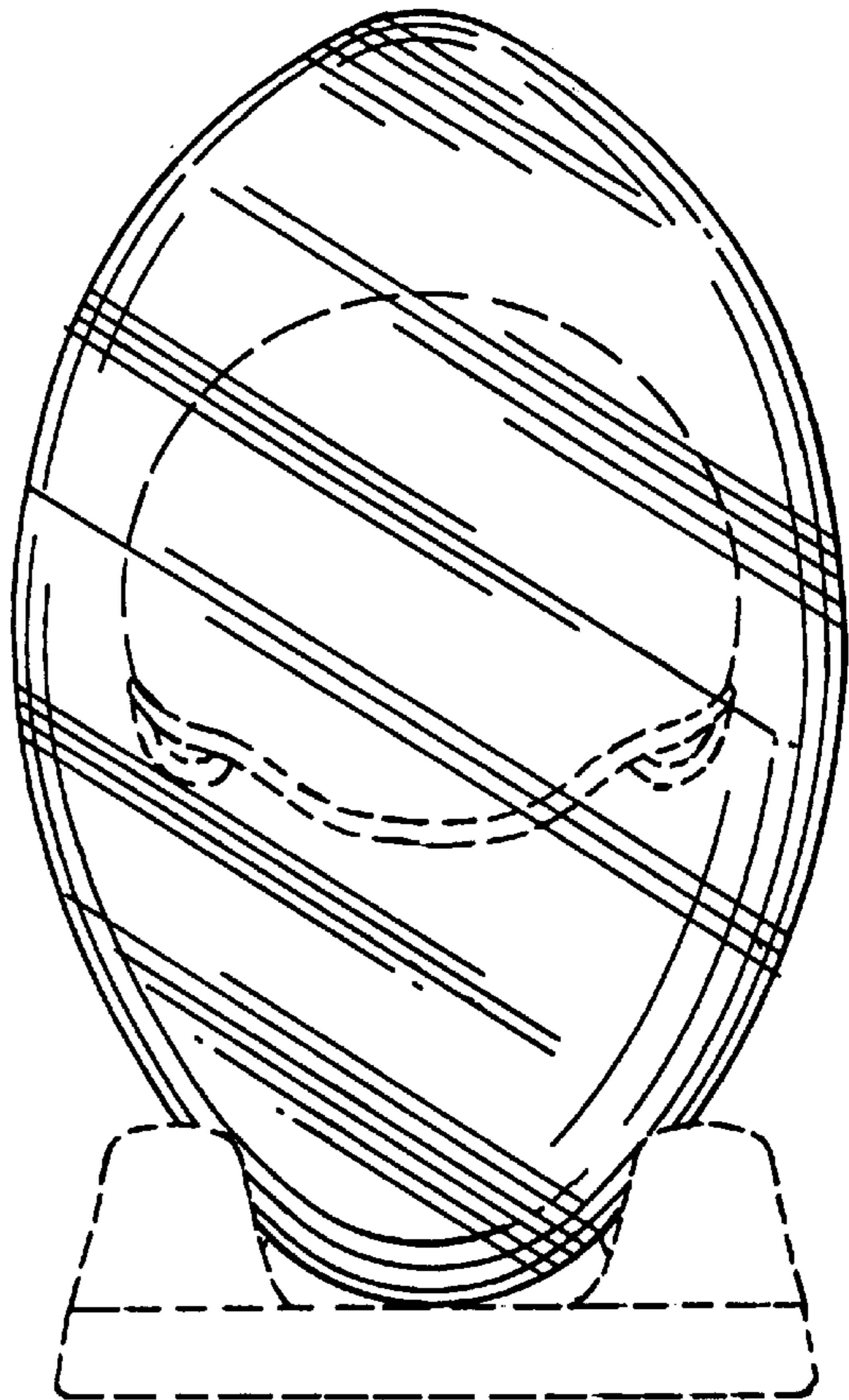

FIG. 5.

FIG. 6.

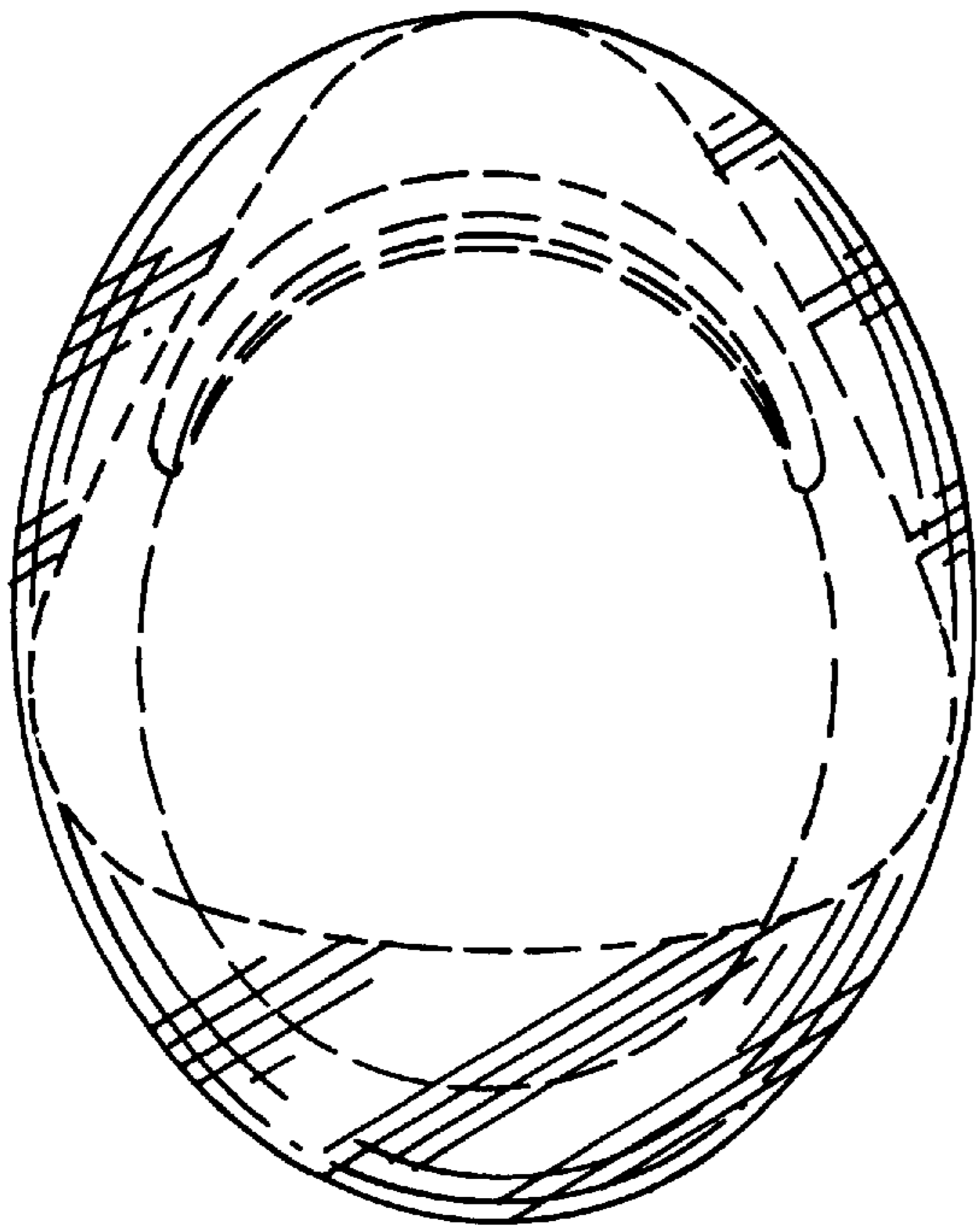
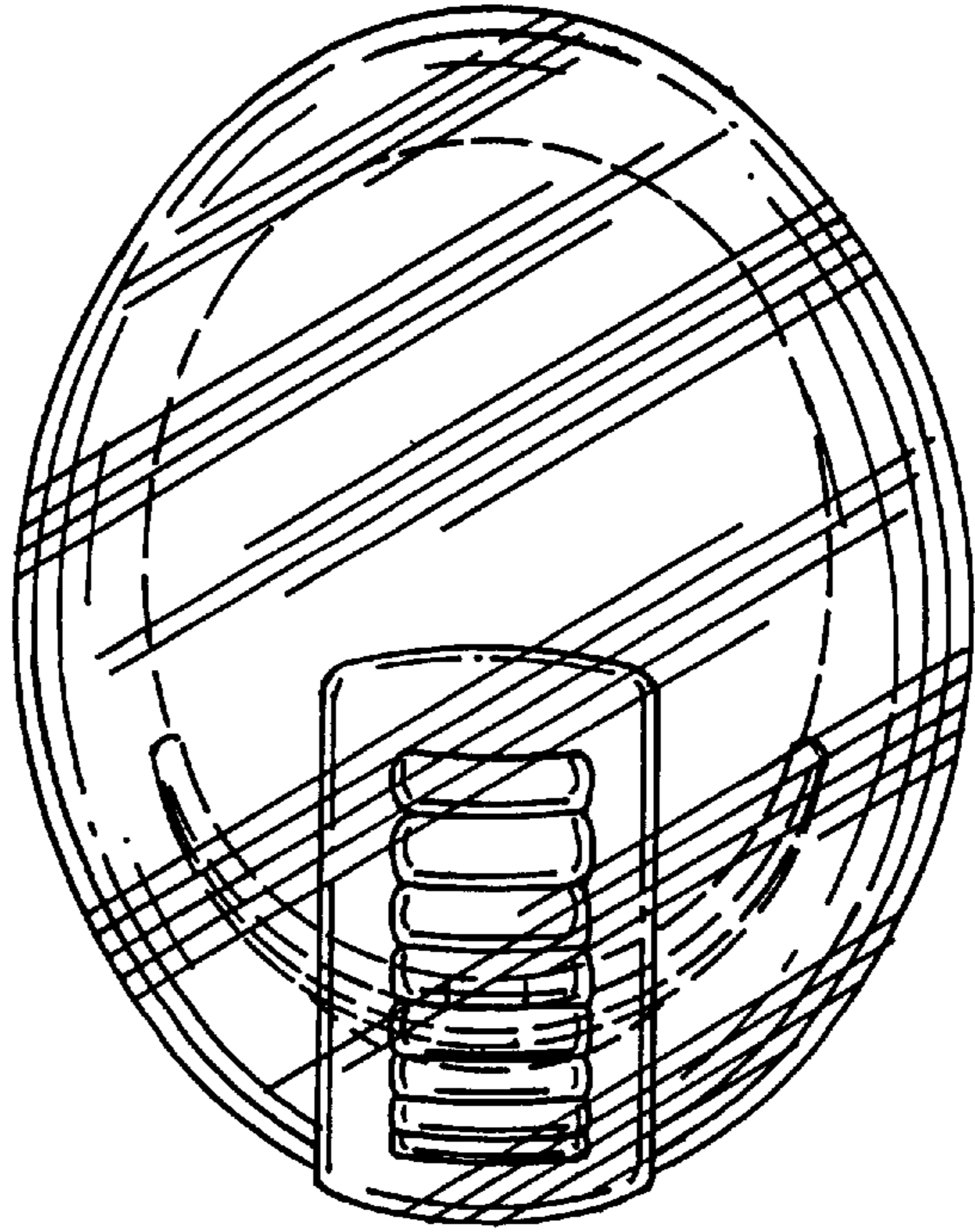

FIG. 7.

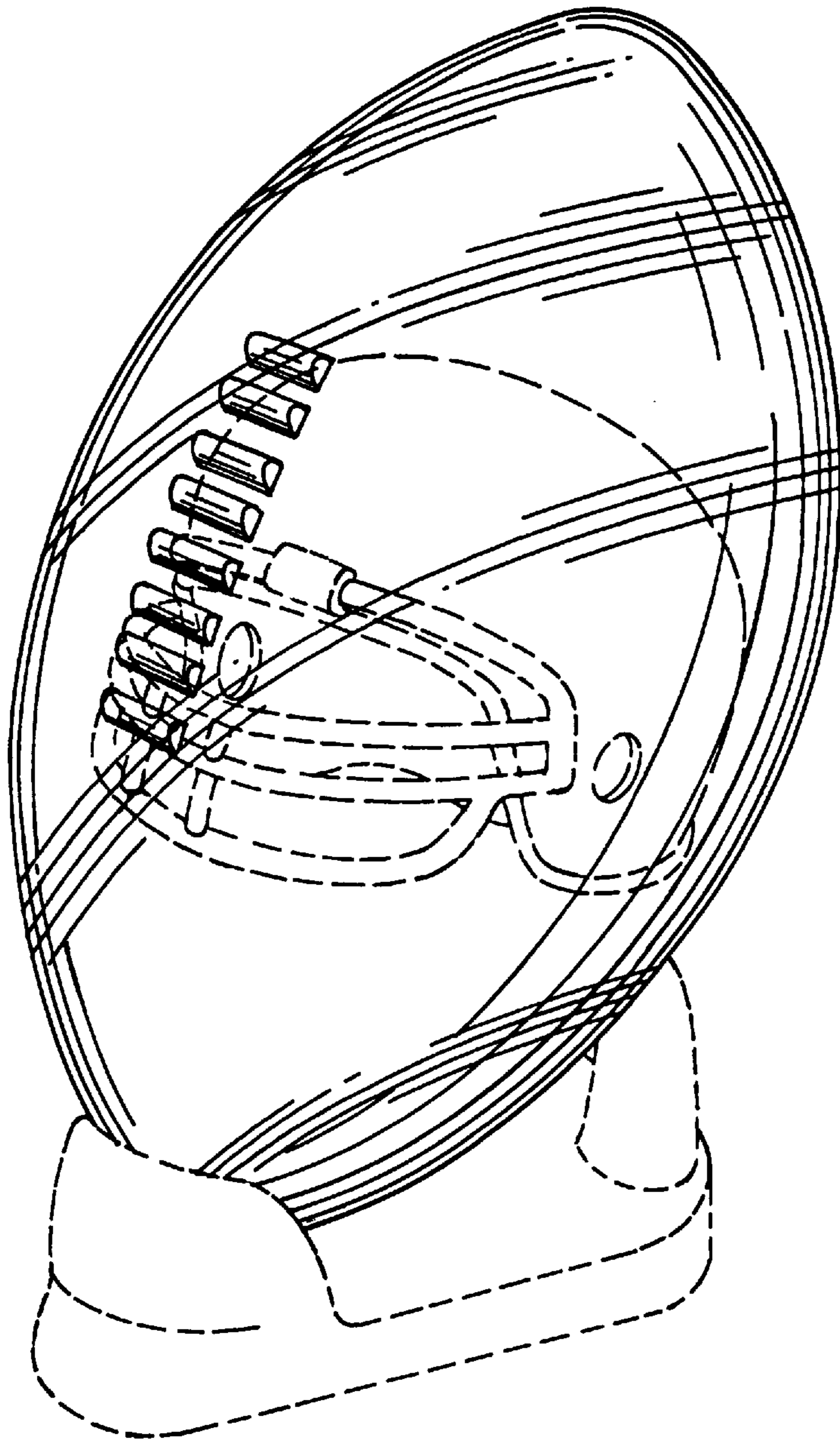

FIG. 8.

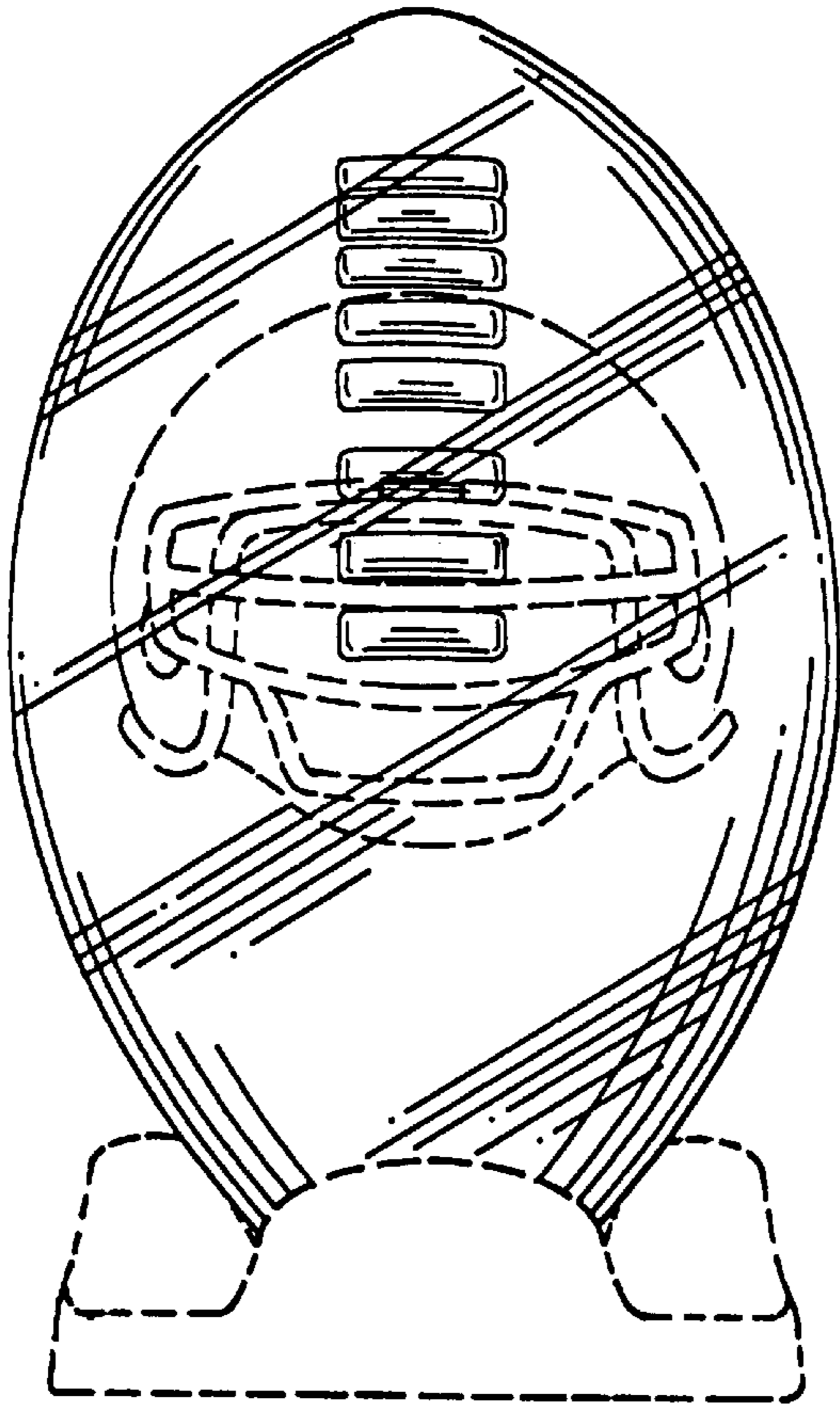

FIG. 9.

FIG. 10.

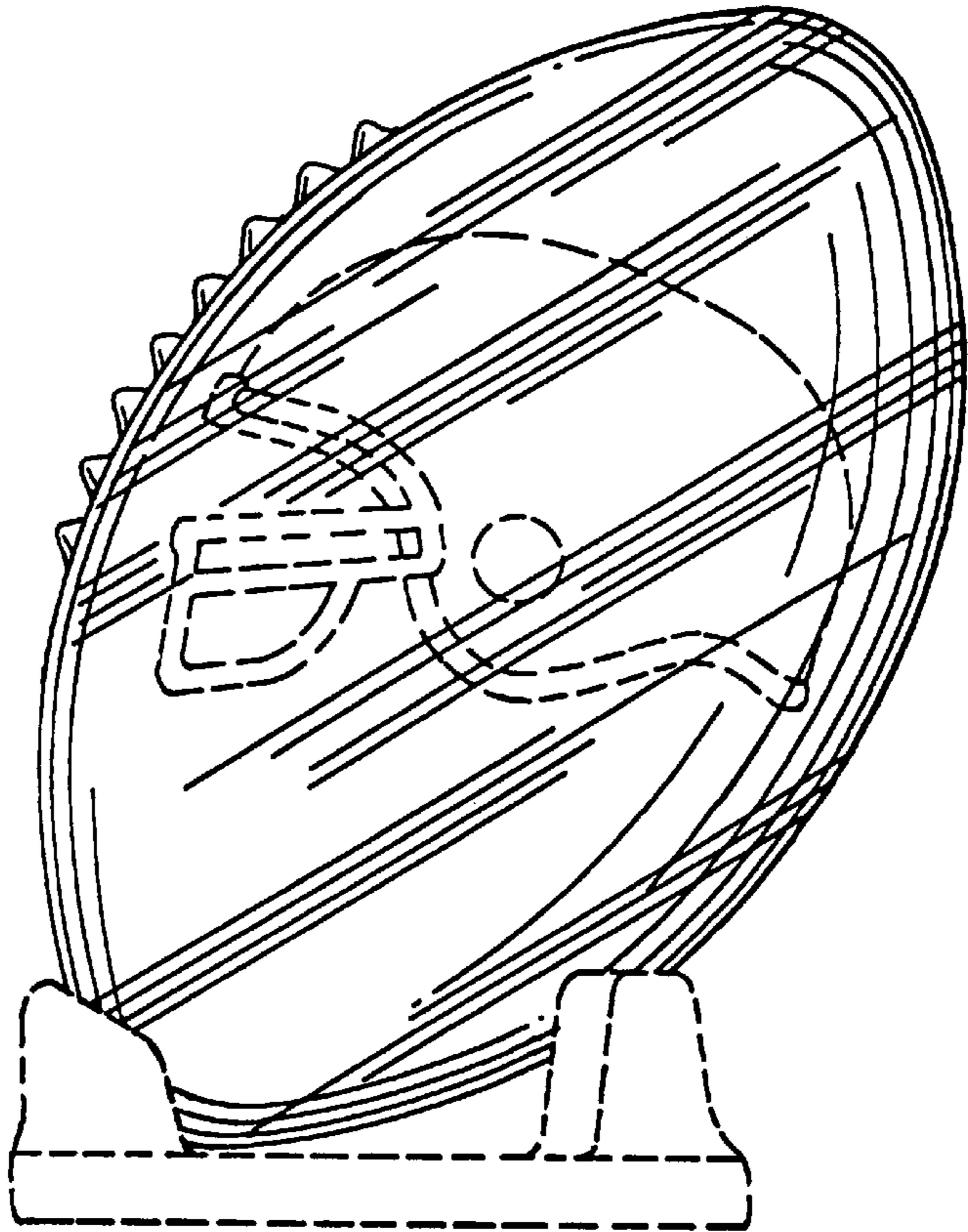

FIG. 11.

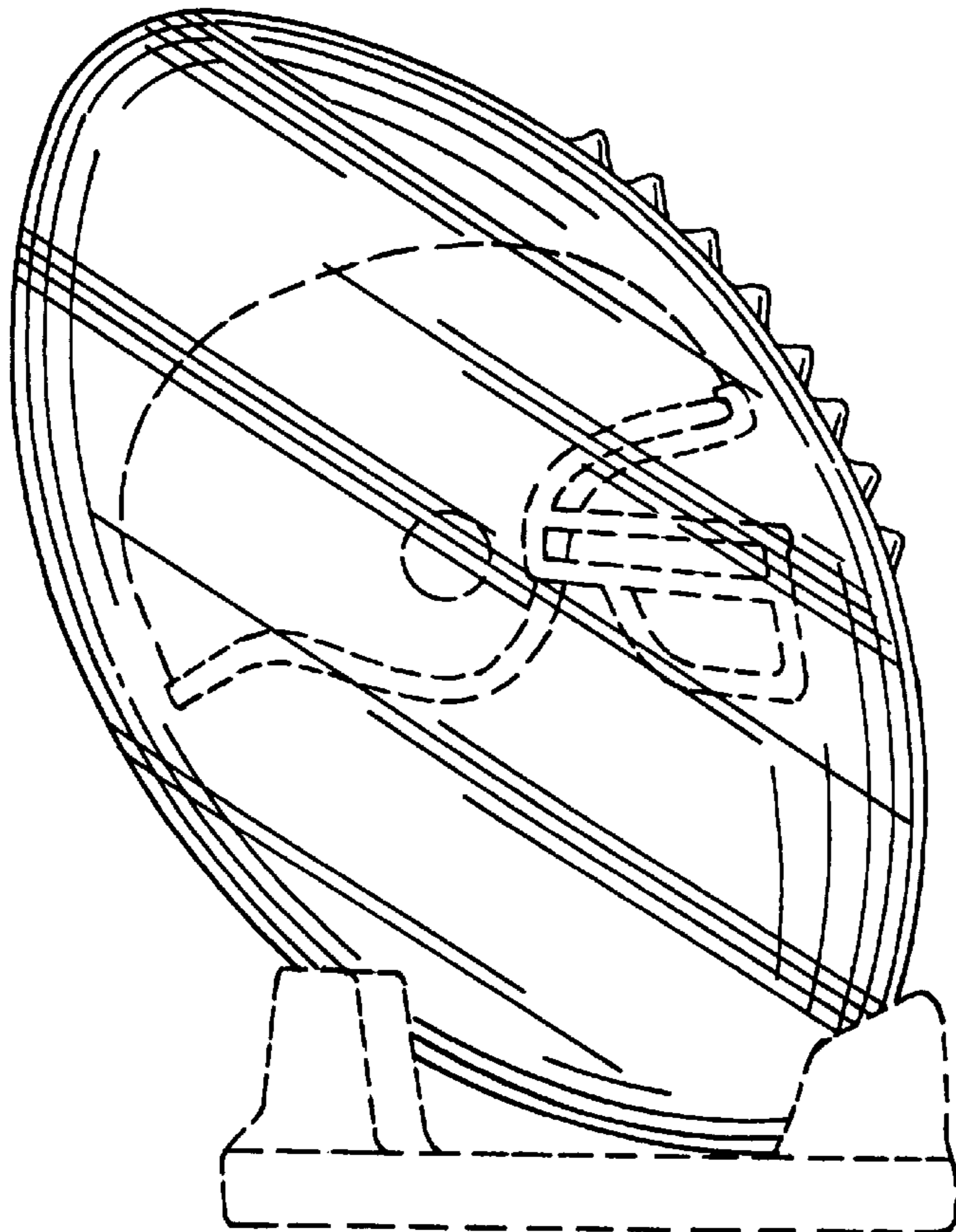
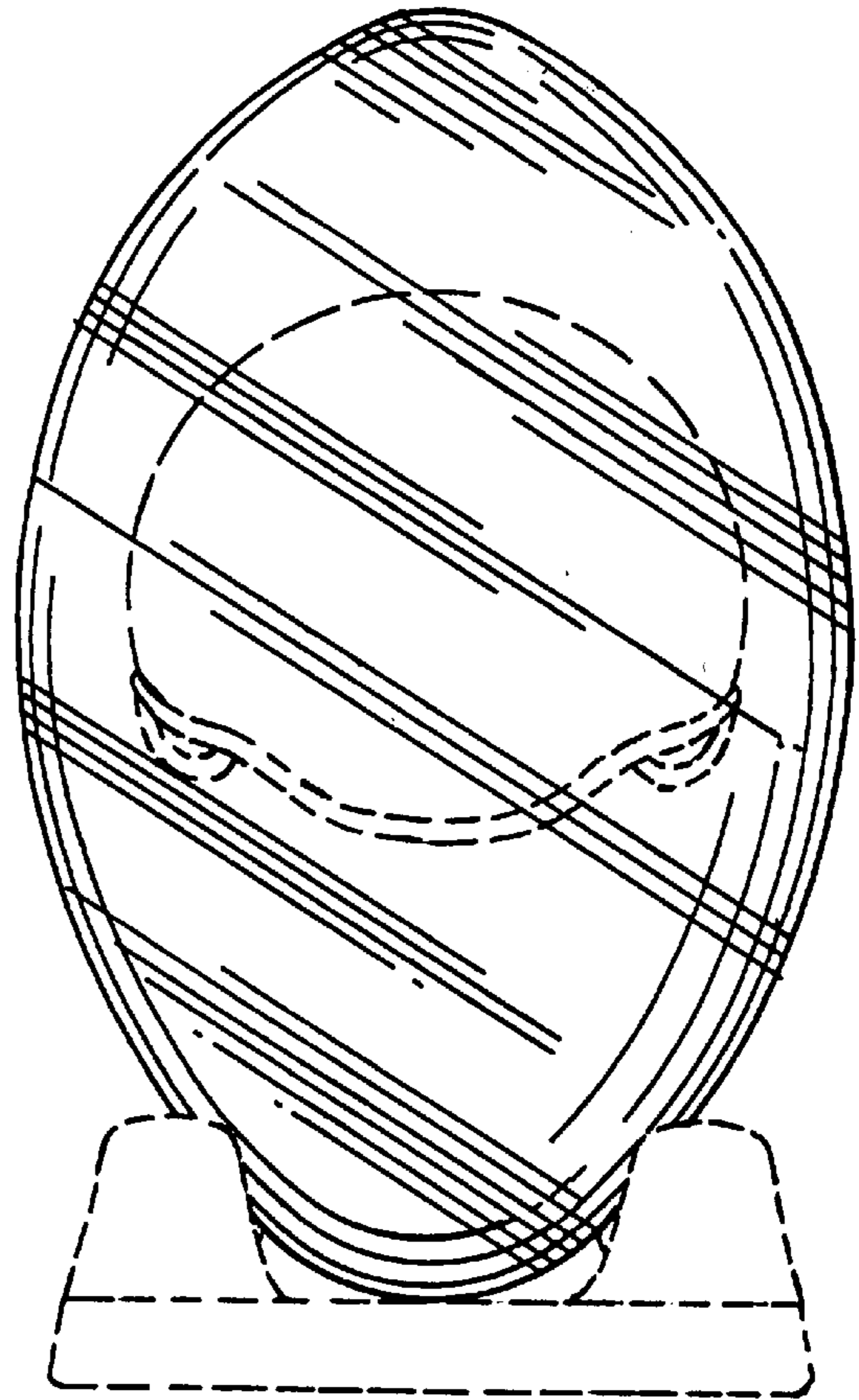

FIG. 12.



FIG. 13.

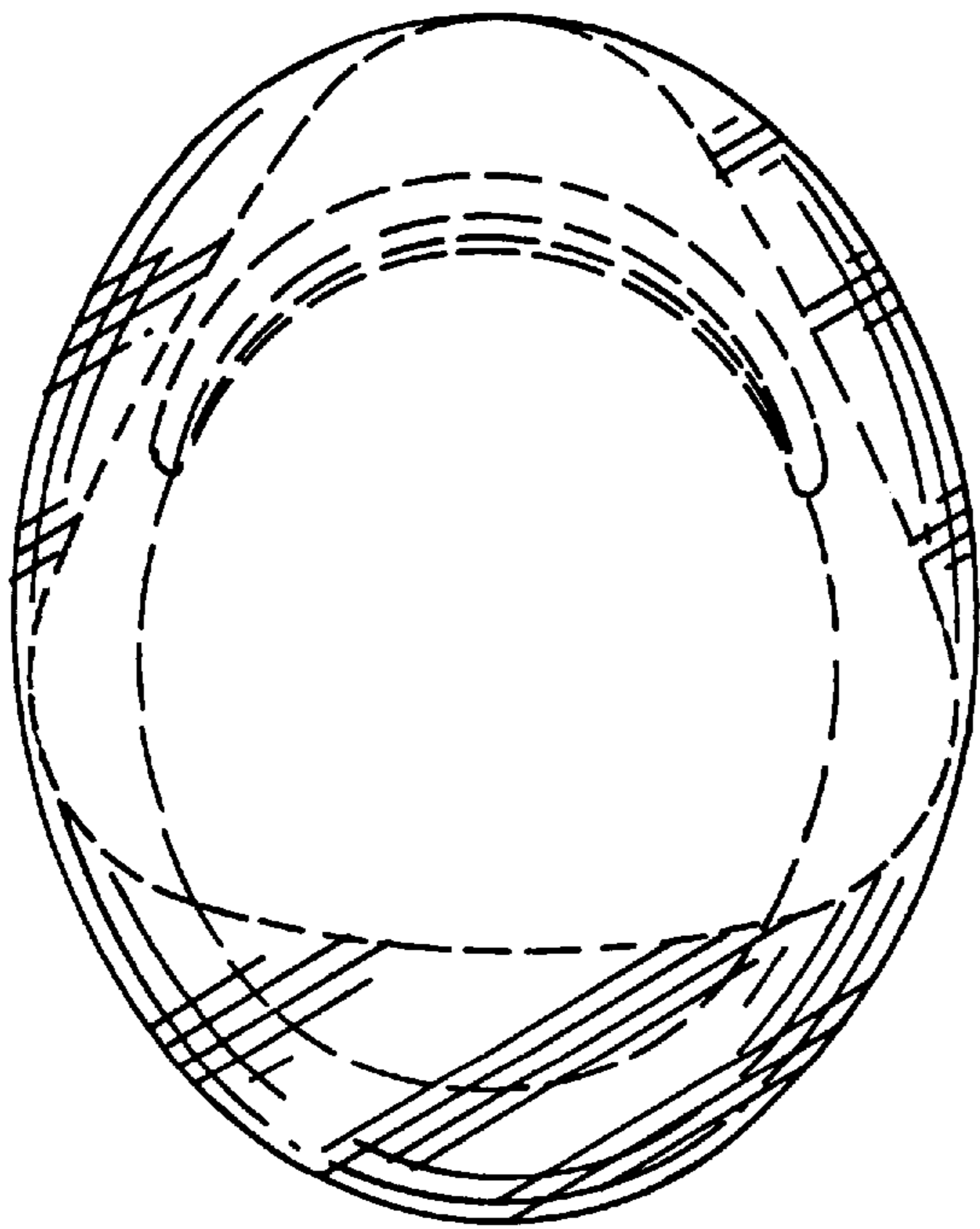
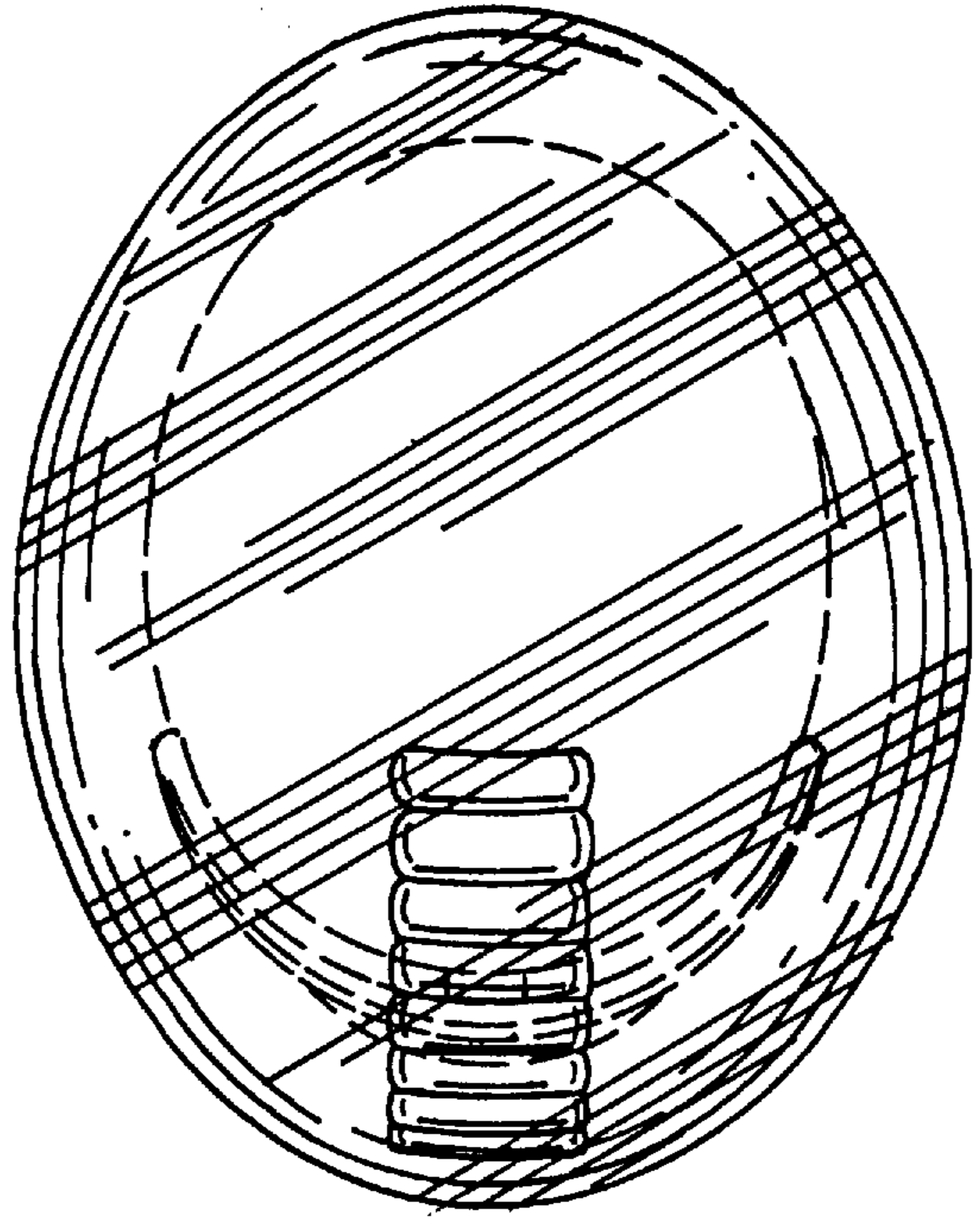

FIG. 14.

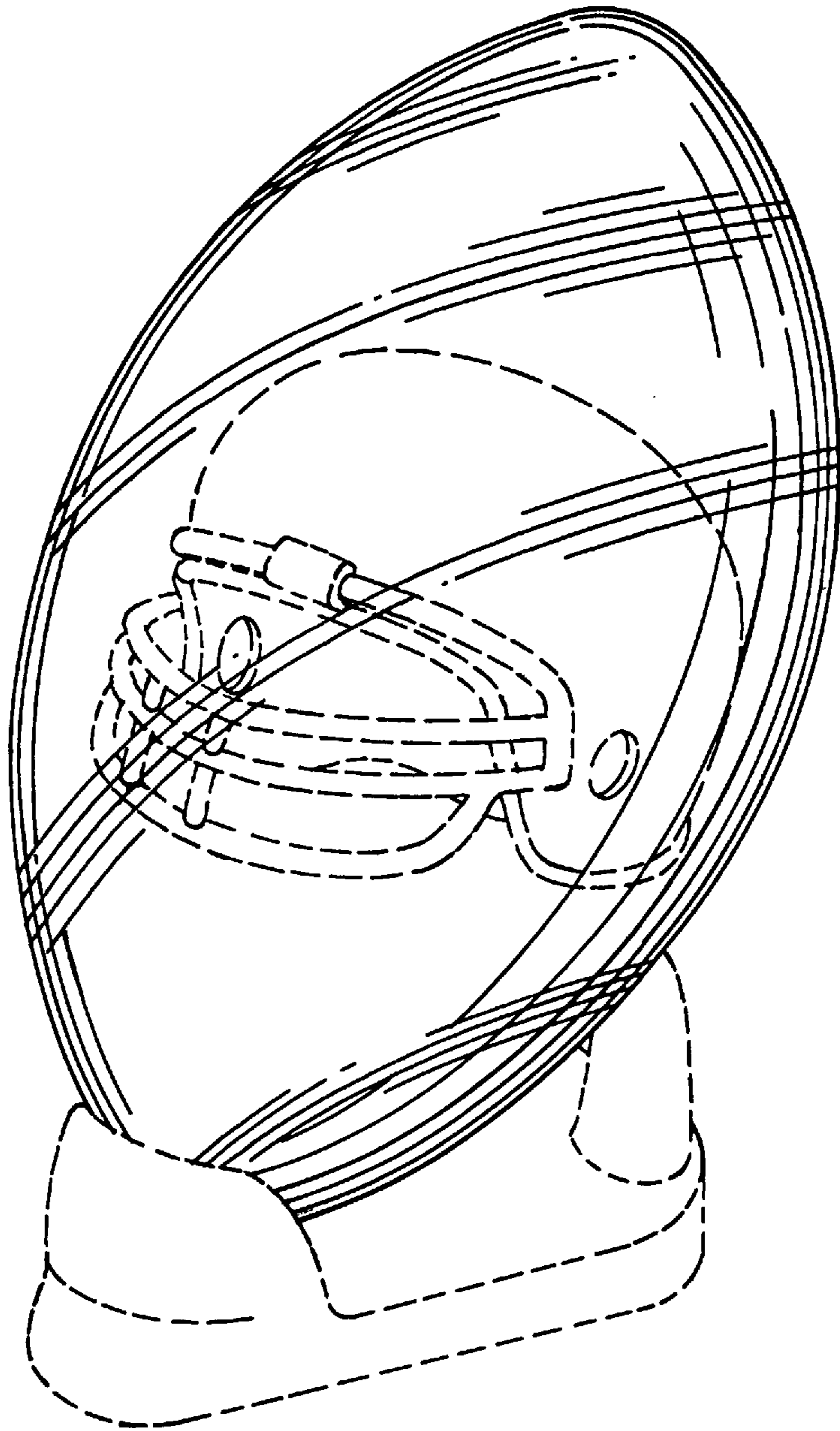

FIG. 15.

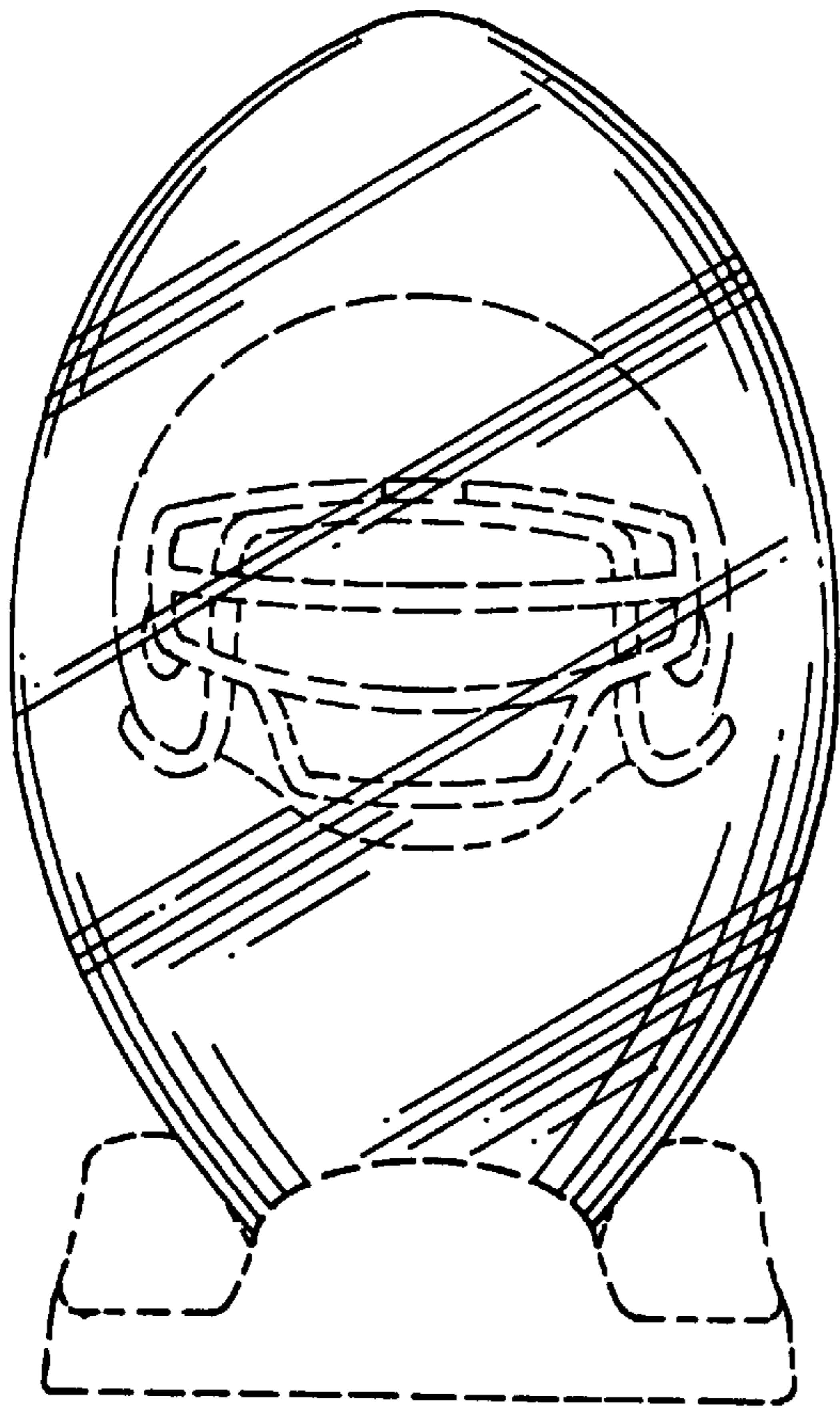

FIG. 16.

FIG. 17.

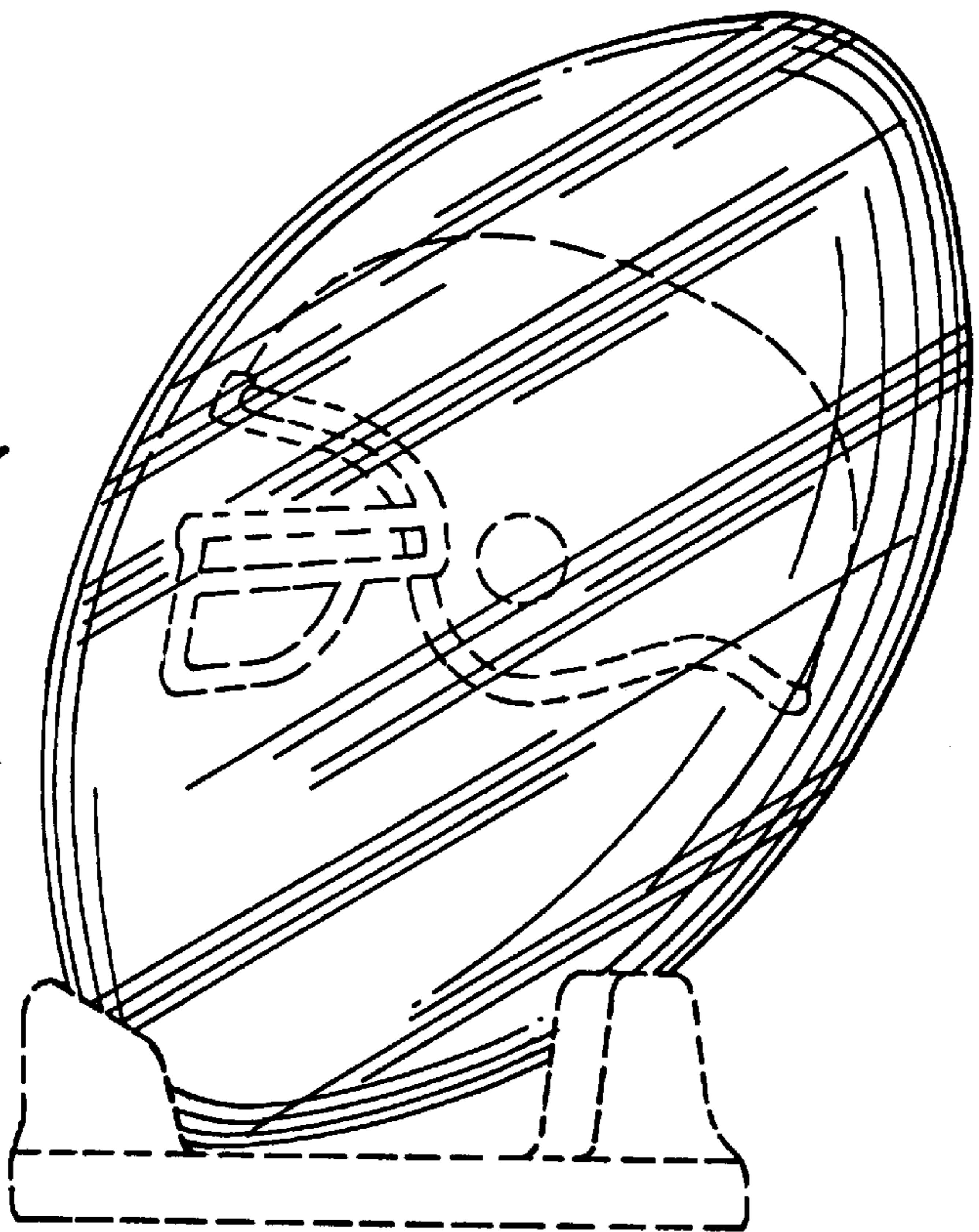

FIG. 18.

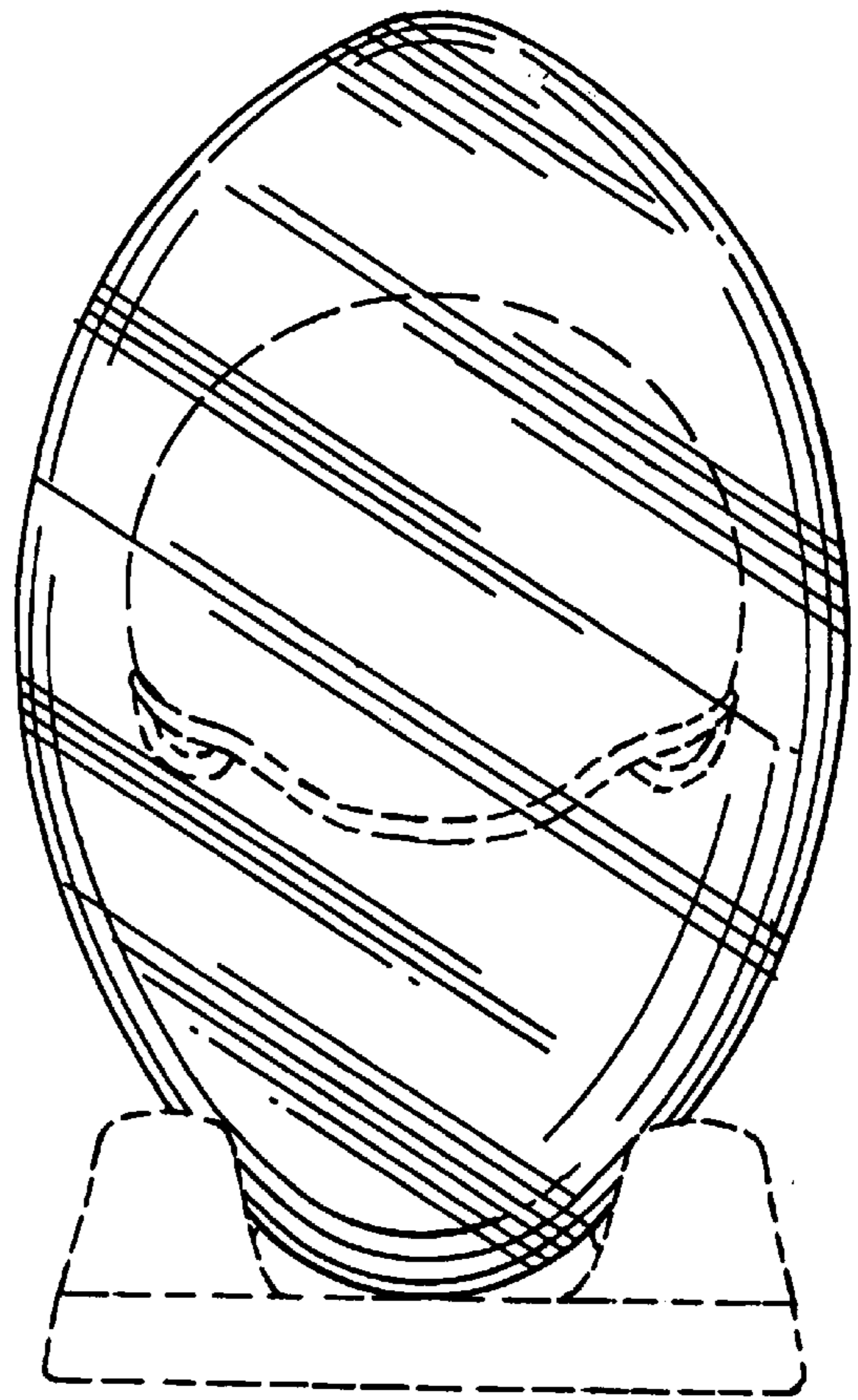

FIG. 19.

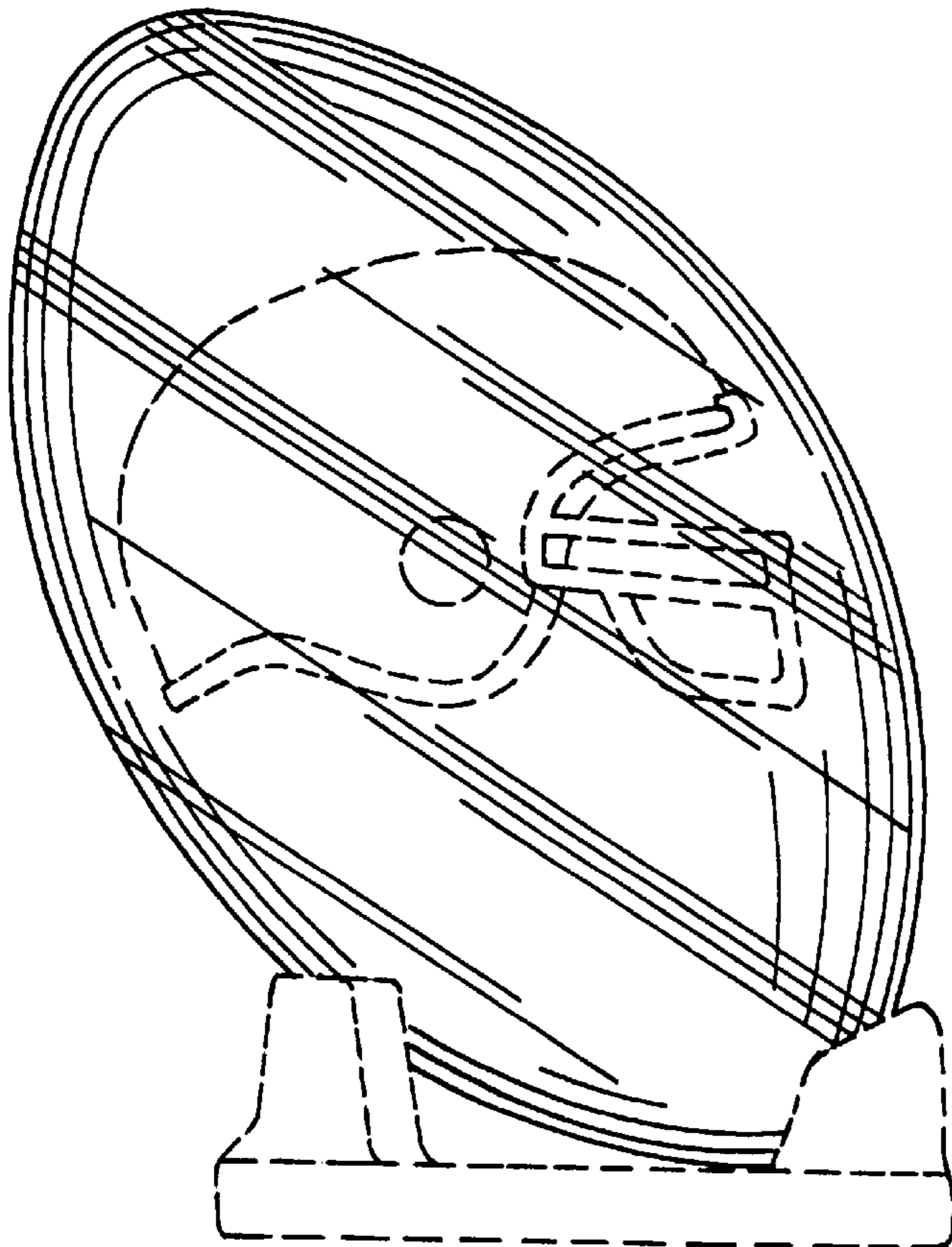

FIG. 20.

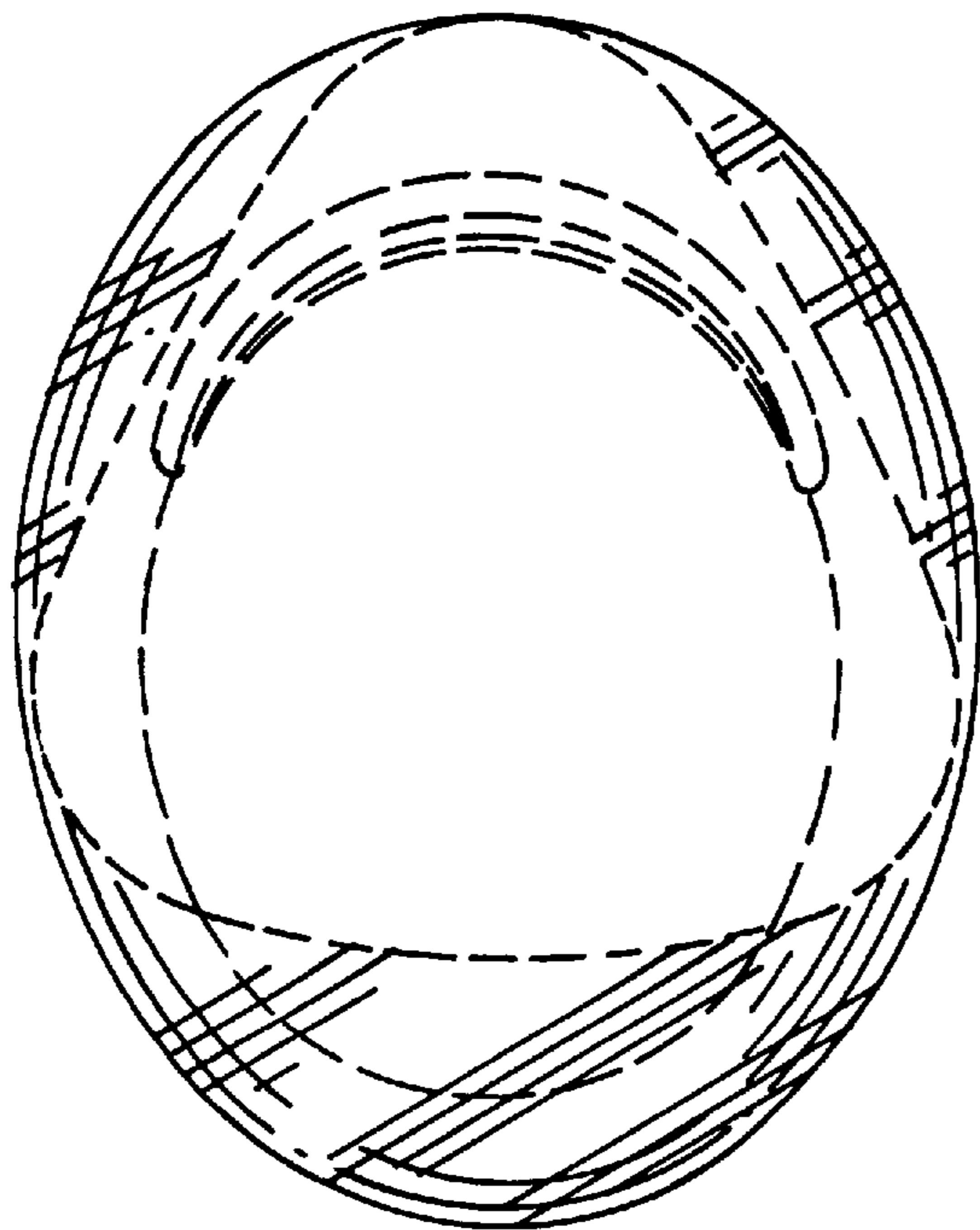
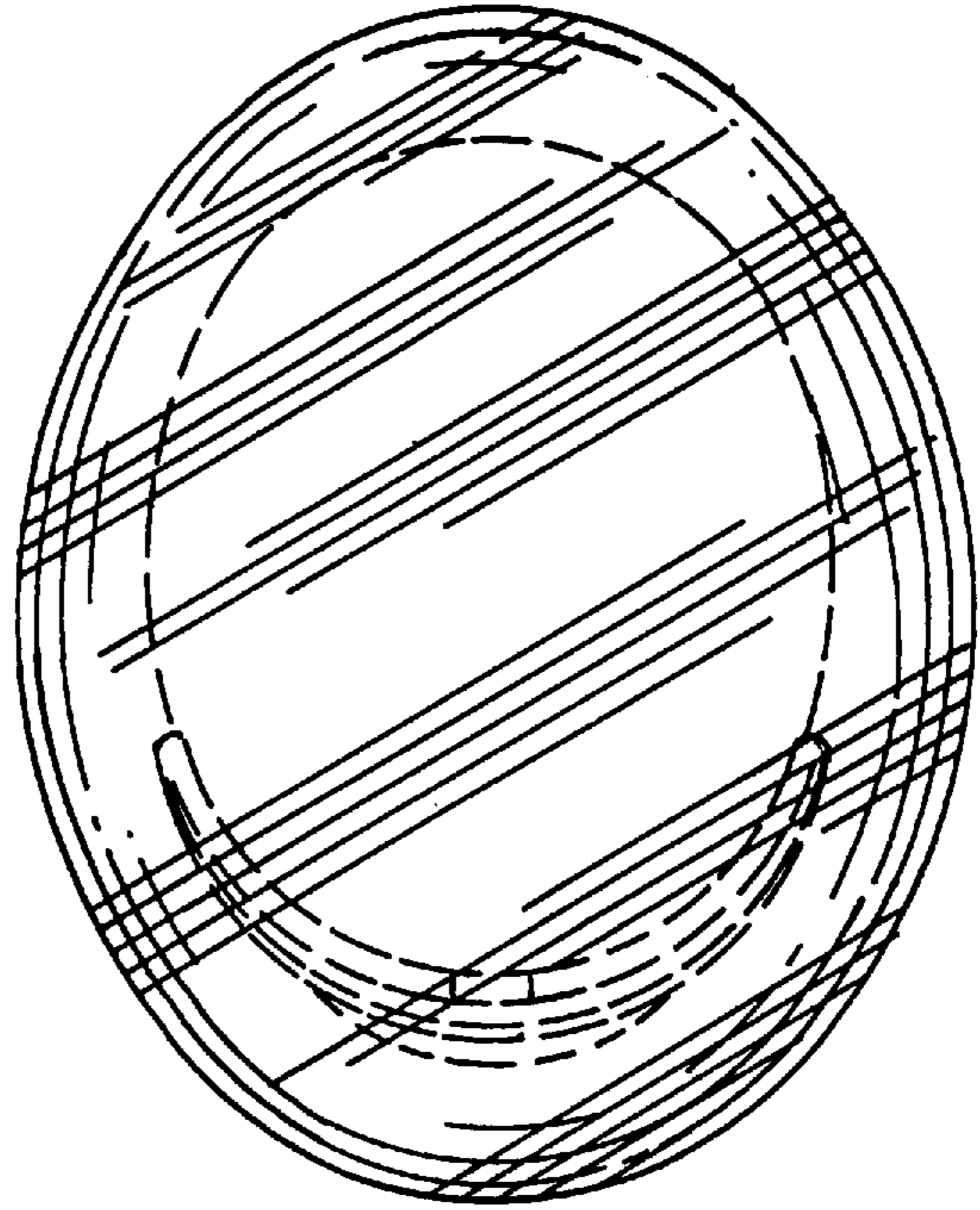

FIG. 21.