



US00D405720S

**United States Patent** [19]  
**Sain**

[11] **Patent Number: Des. 405,720**

[45] **Date of Patent: \*\*Feb. 16, 1999**

[54] **AWARD PLAQUE**

[76] Inventor: **Kenneth W. Sain**, 4501 W. Arthur Ave., Lincolnwood, Ill. 60646

[\*\*] Term: **14 Years**

[21] Appl. No.: **90,797**

[22] Filed: **Jul. 16, 1998**

[51] **LOC (6) Cl.** ..... **11-05**

[52] **U.S. Cl.** ..... **D11/133**

[58] **Field of Search** ..... D11/132, 133;  
D2/882; 428/542.2, 542.4, 542.6, 913.3

[56] **References Cited**

**U.S. PATENT DOCUMENTS**

D. 39,202	3/1908	Mattes	.....	D2/882
D. 221,389	8/1971	Rhea	.....	D11/133
D. 240,365	6/1976	Bennett	.....	D11/133
D. 260,748	9/1981	Buschmann	.....	D11/133
D. 356,977	4/1995	Roethler	.....	D11/133
D. 393,603	4/1998	Cerisano	.....	D11/133
4,125,655	11/1978	Kanzelberger	.....	D11/133 X

*Primary Examiner*—Dominic Simone

[57] **CLAIM**

I claim the ornamental design for an award plaque, as shown and described.

**DESCRIPTION**

FIG. 1 is a front elevational view of an award plaque

showing my new design;

FIG. 2 is a top plan view thereof;

FIG. 3 is a left side elevational view, the opposite side view being a mirror image thereof;

FIG. 4 is a bottom plan view thereof;

FIG. 5 is a front elevational view of a second embodiment of FIG. 1;

FIG. 6 is a top plan view thereof;

FIG. 7 is a left side elevational view, the opposite side view being a mirror image thereof;

FIG. 8 is a bottom plan view thereof;

FIG. 9 is a front elevational view of a third embodiment of FIG. 1;

FIG. 10 is a top plan view thereof;

FIG. 11 is a left side elevational view, the opposite side view being a mirror image thereof;

FIG. 12 is a bottom plan view thereof;

FIG. 13 is a front elevational view of a fourth embodiment of FIG. 1;

FIG. 14 is a top plan view thereof;

FIG. 15 is a left side elevational view, the opposite side view being a mirror image thereof; and,

FIG. 16 is a bottom plan view thereof.

The rear of the award plaque in all embodiments is substantially plain and unornamented.

**1 Claim, 4 Drawing Sheets**

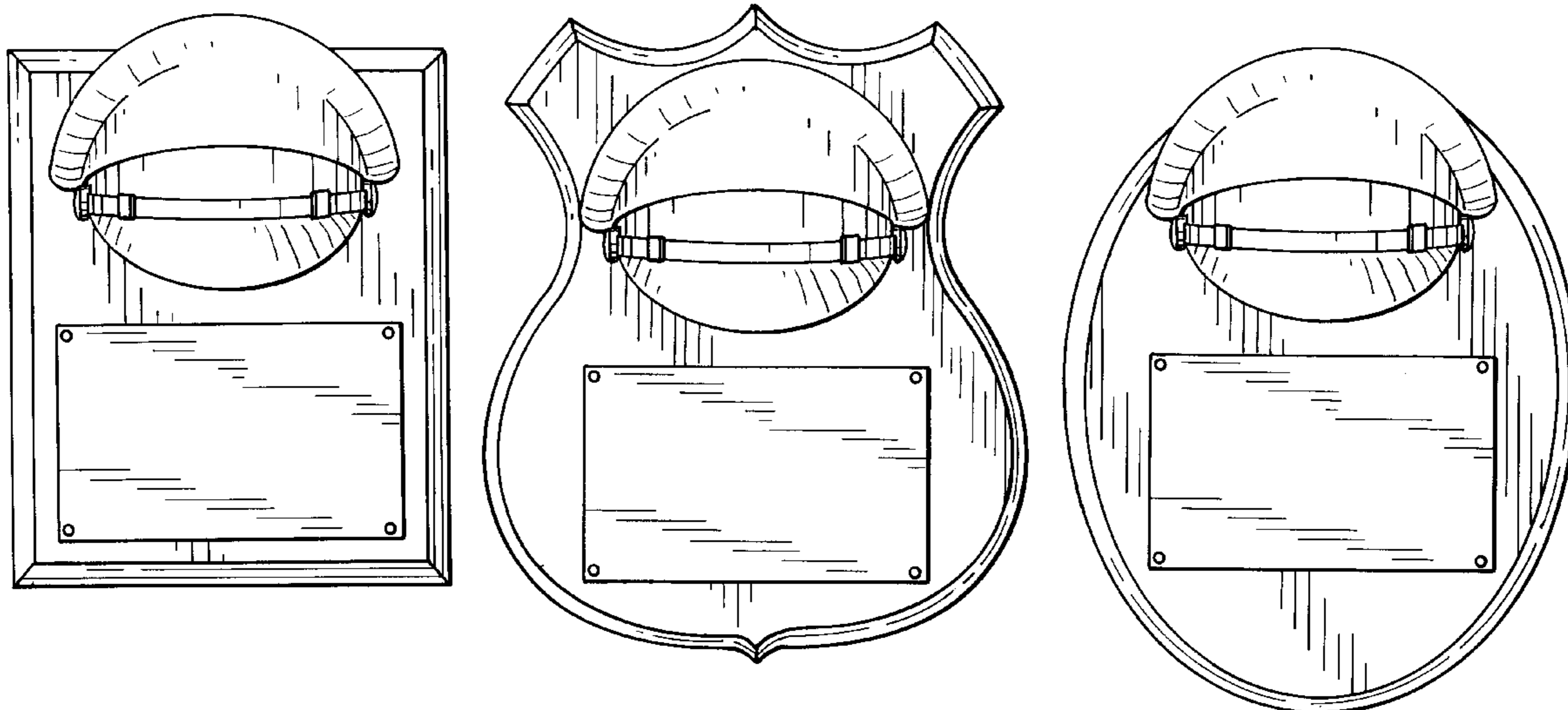

FIG. 2

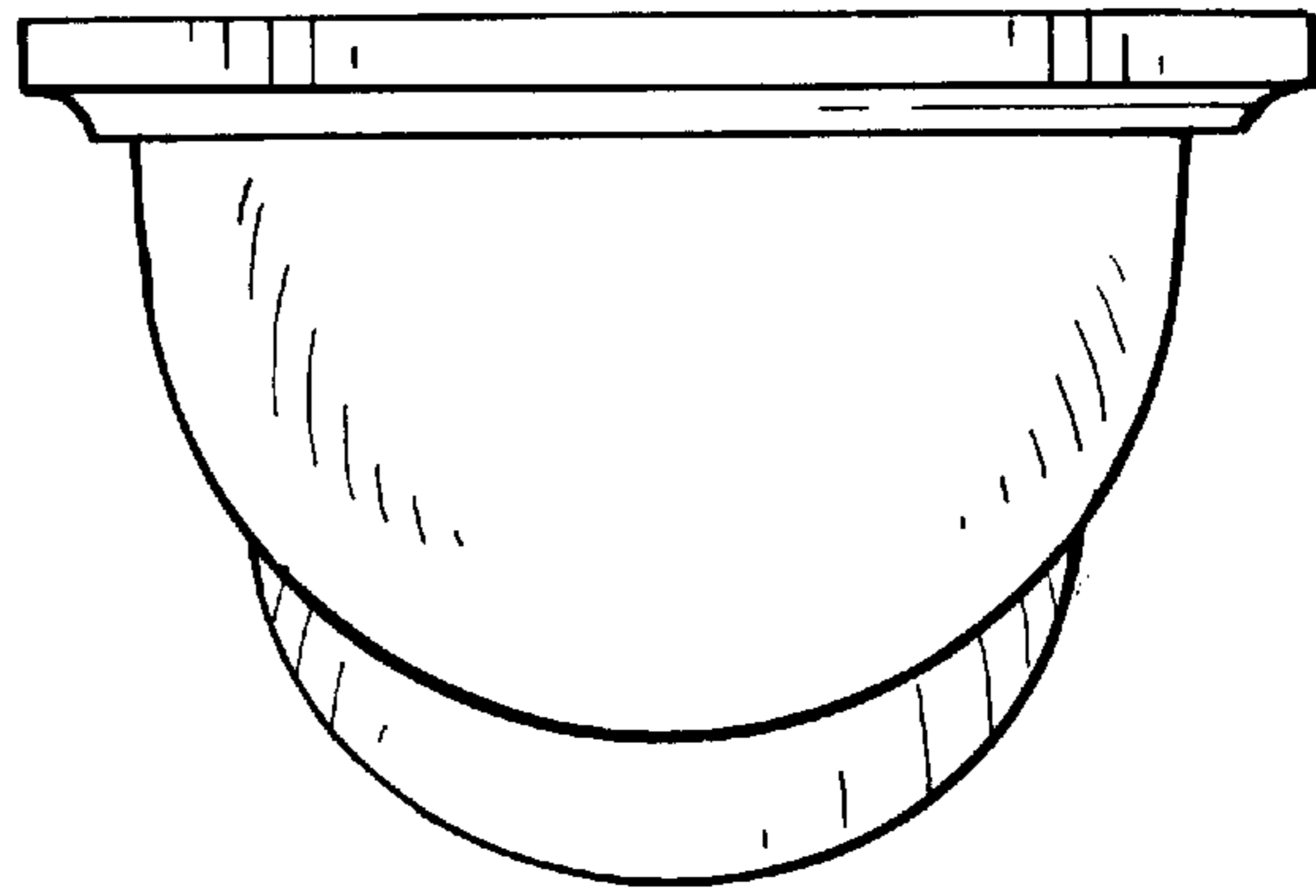

FIG. 3

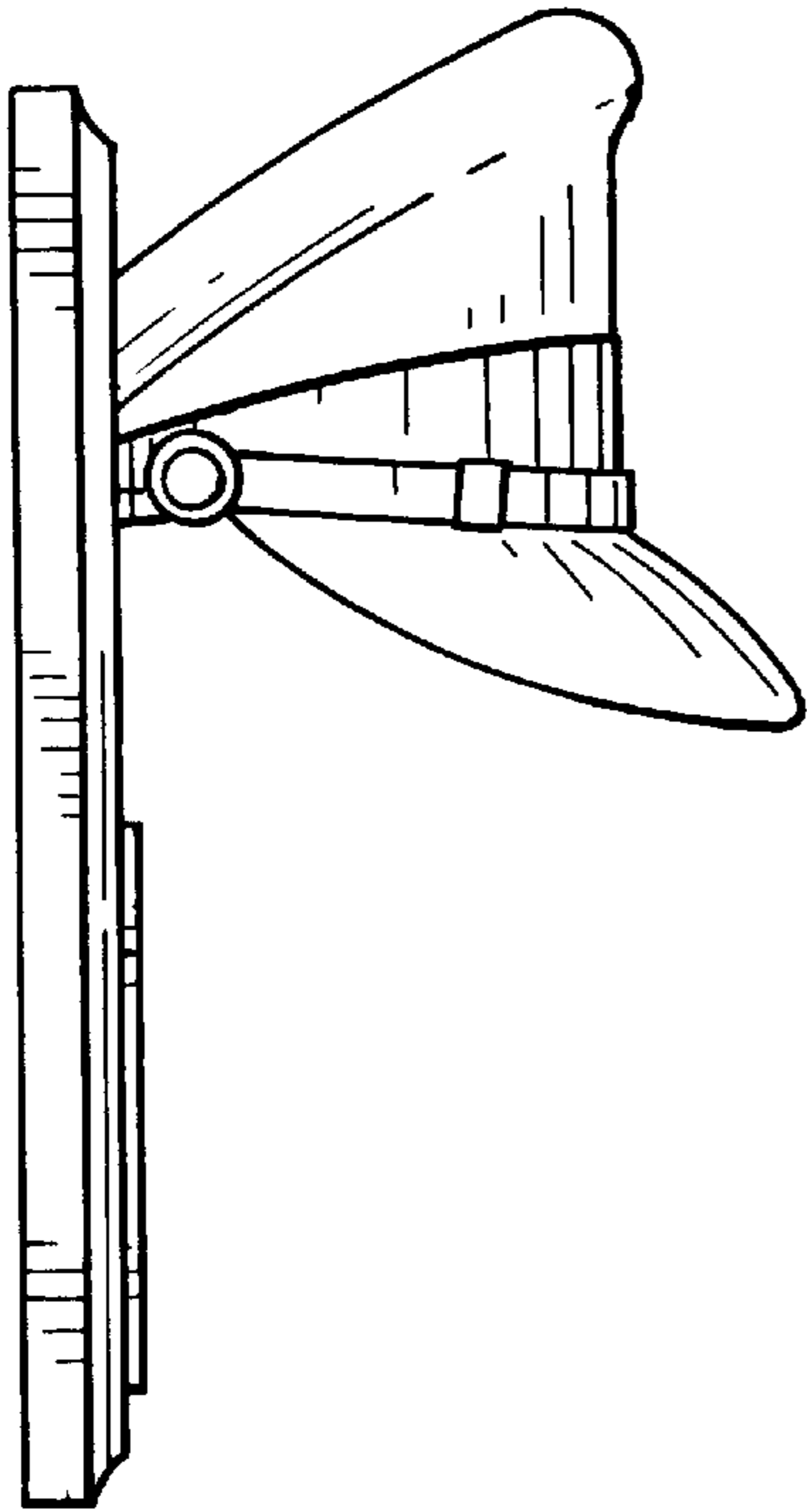

FIG. 1

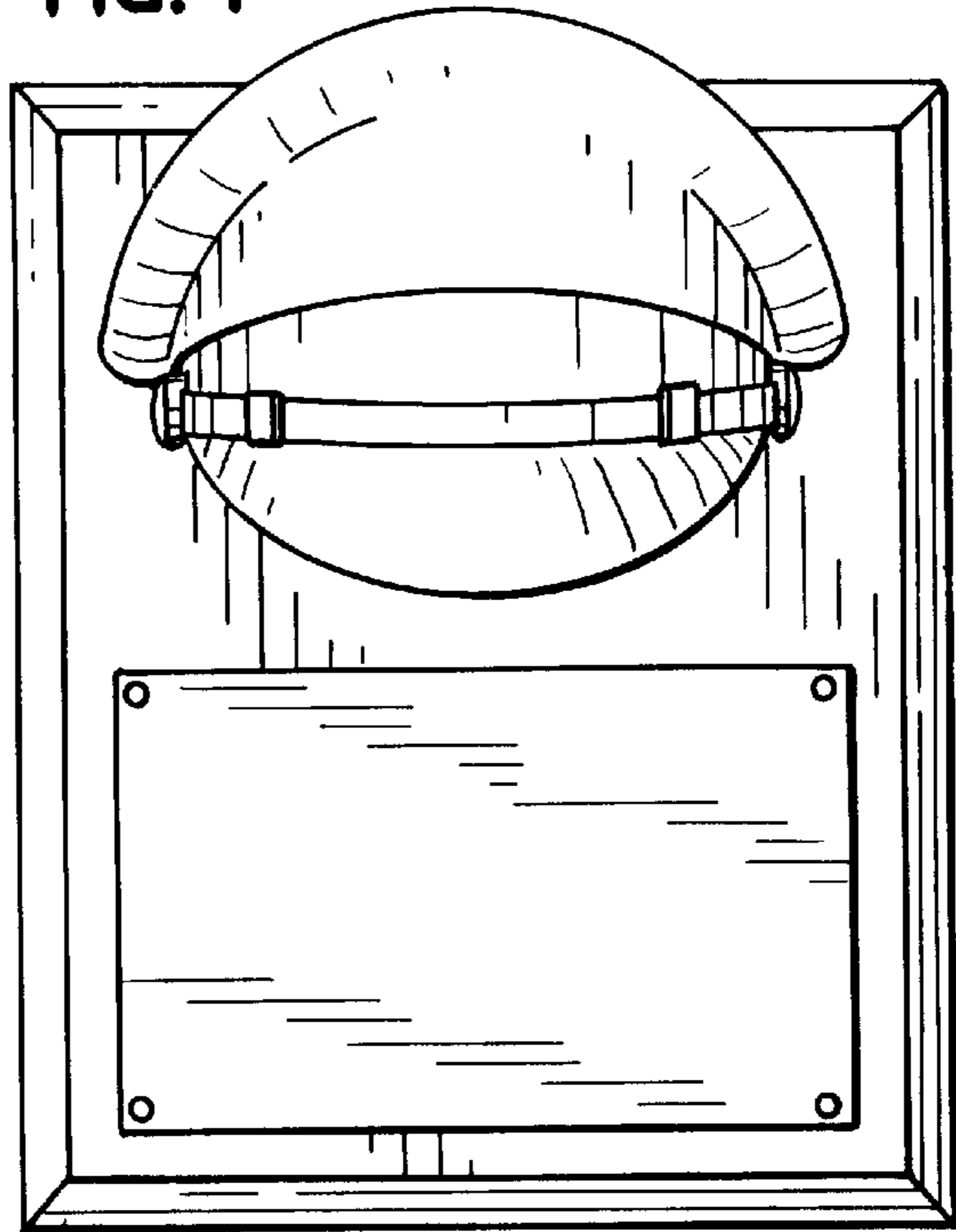

FIG. 4

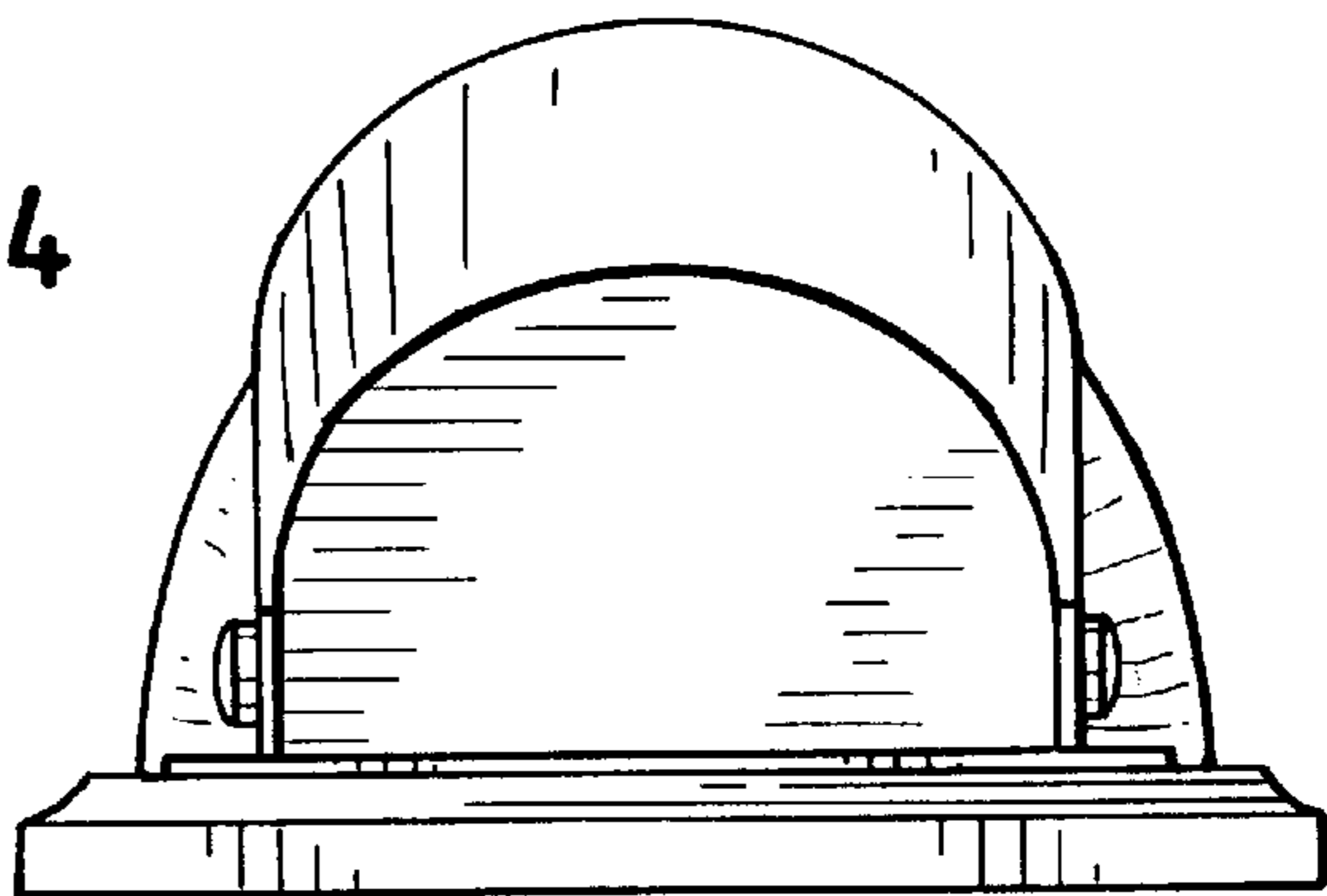

FIG. 6

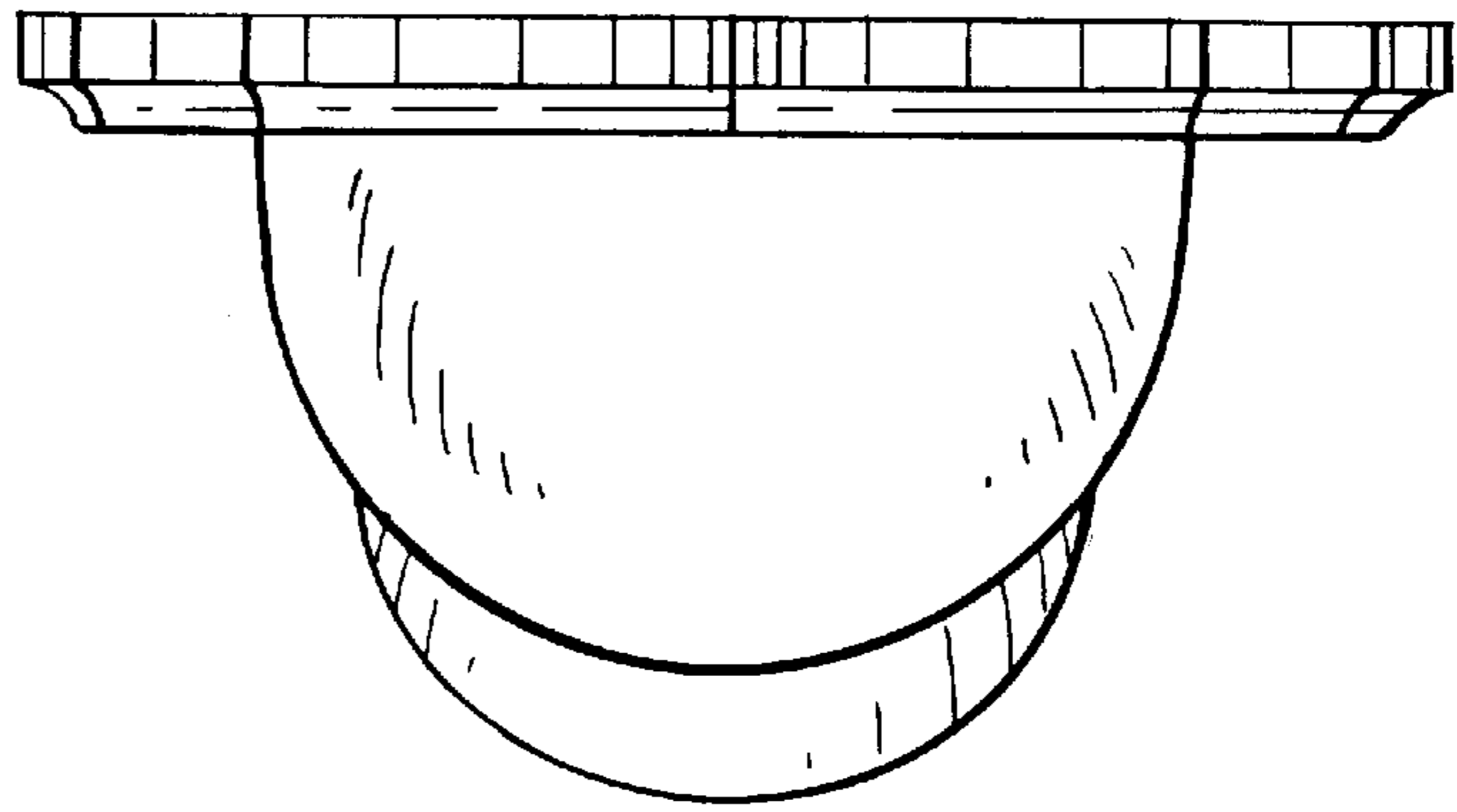

FIG. 7

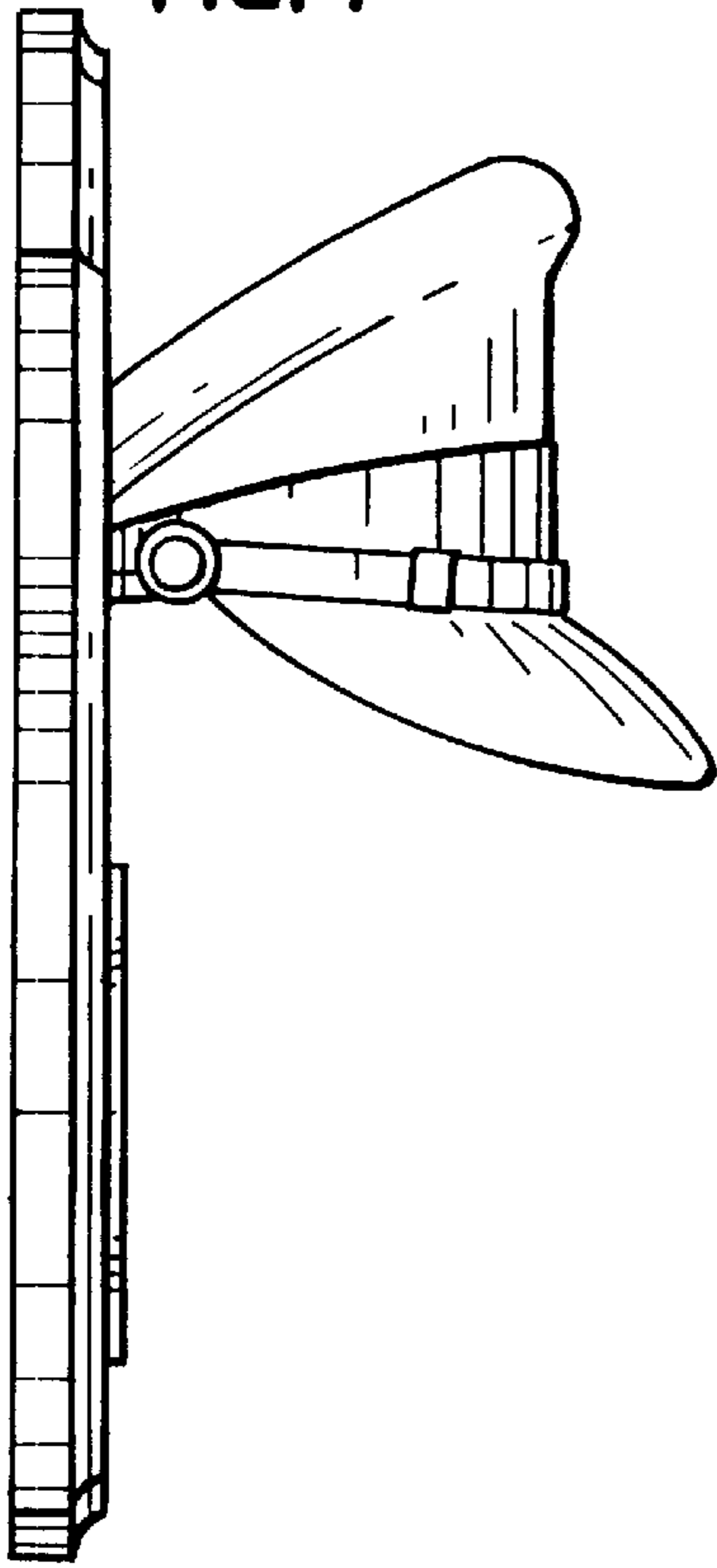

FIG. 5

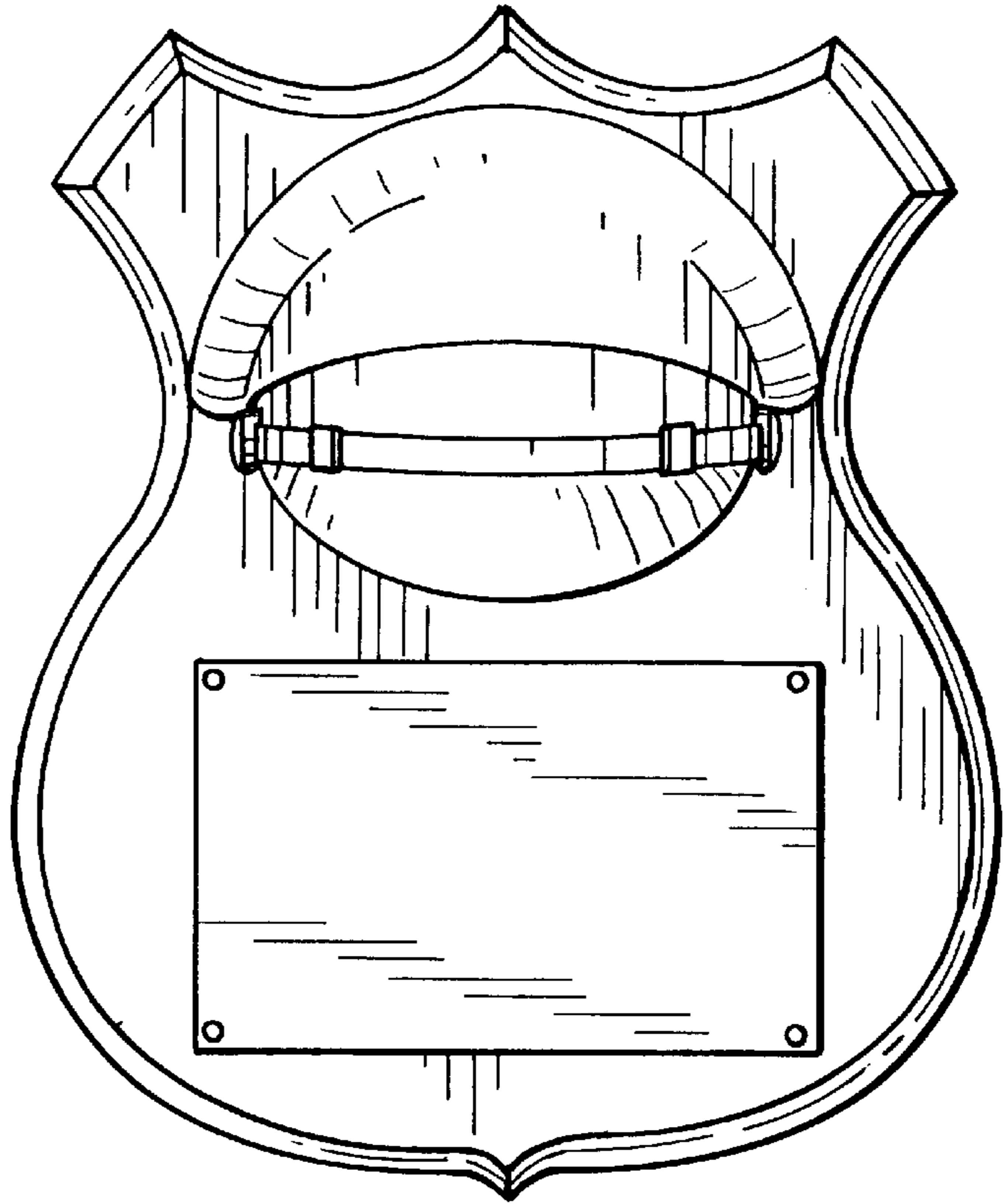

FIG. 8

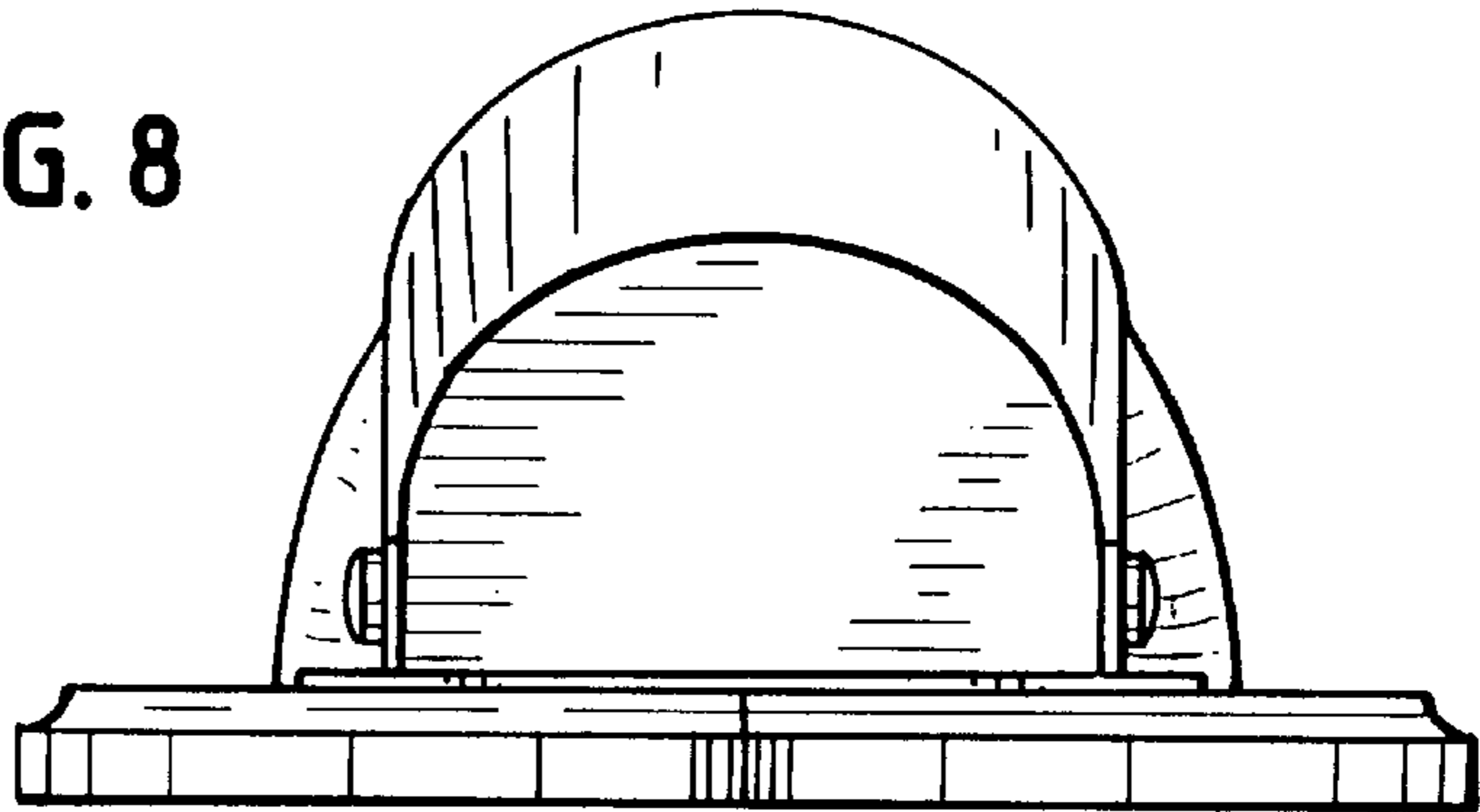

FIG. 10

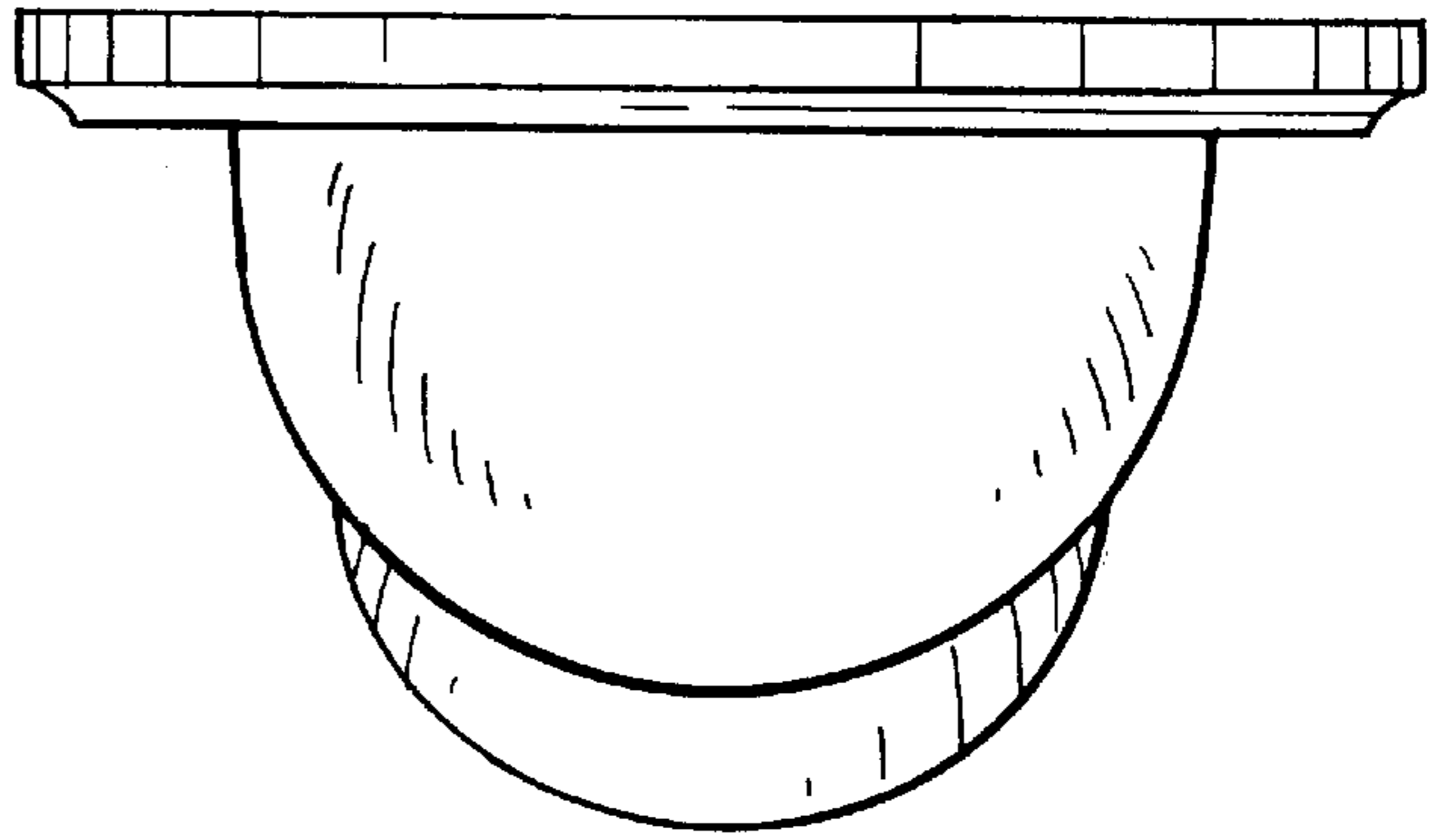

FIG. 11

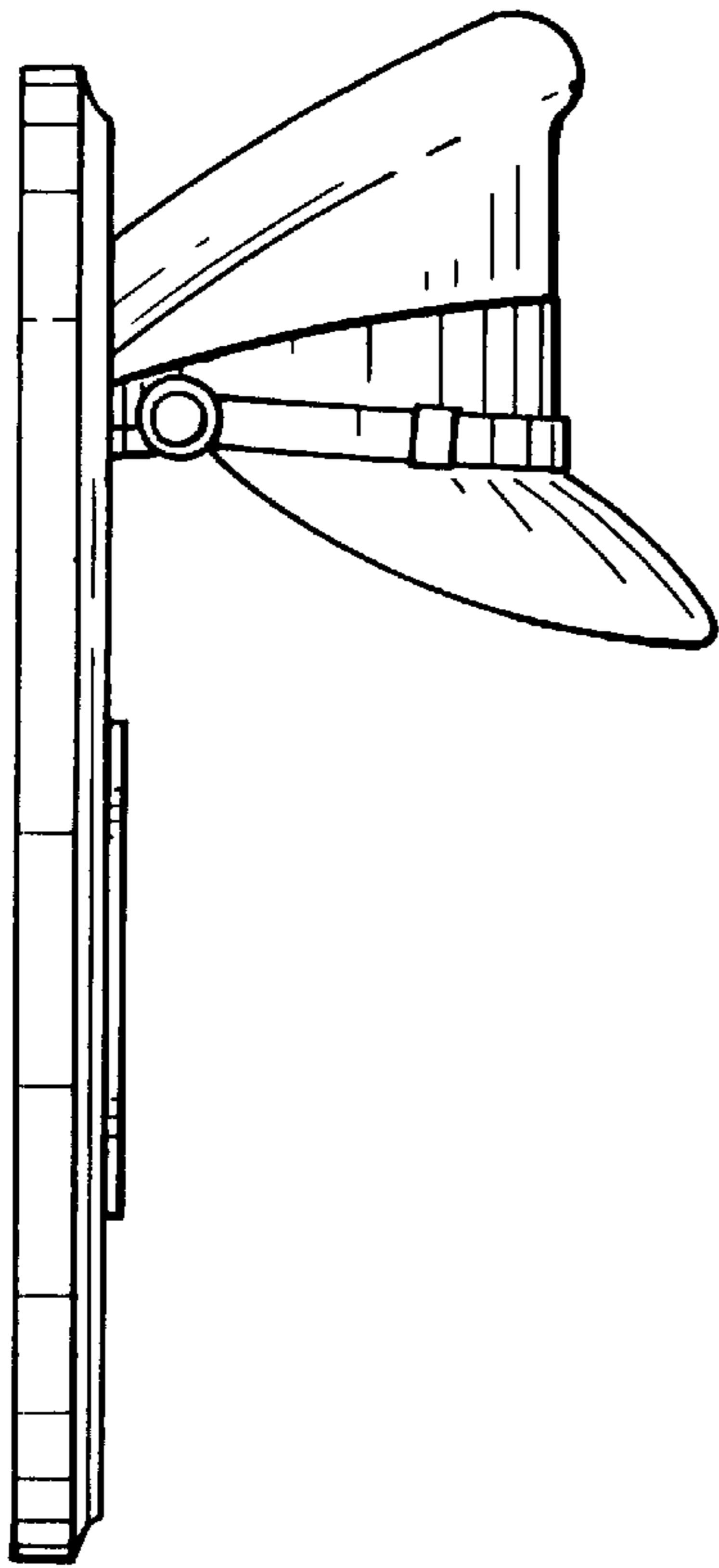

FIG. 9

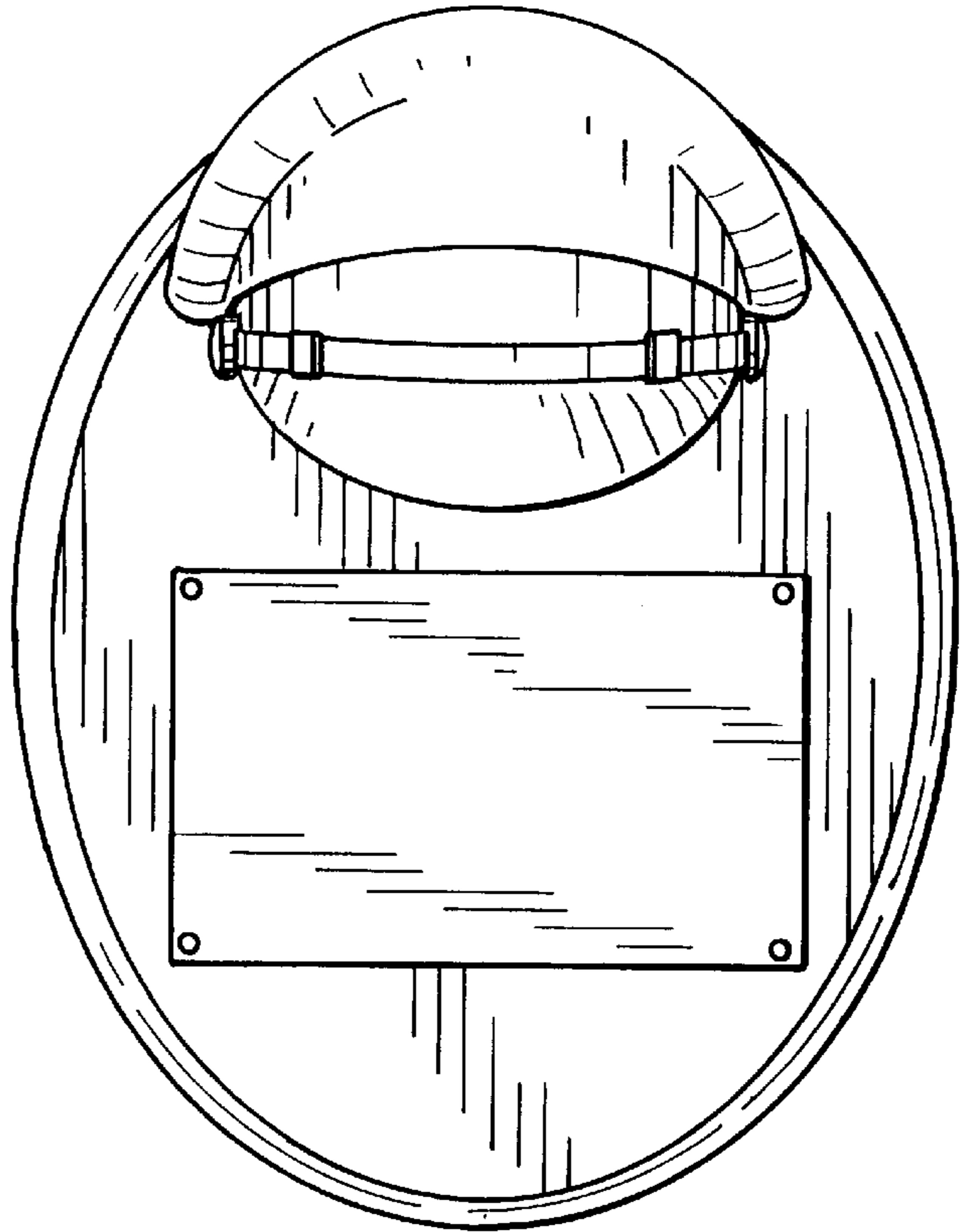

FIG. 12

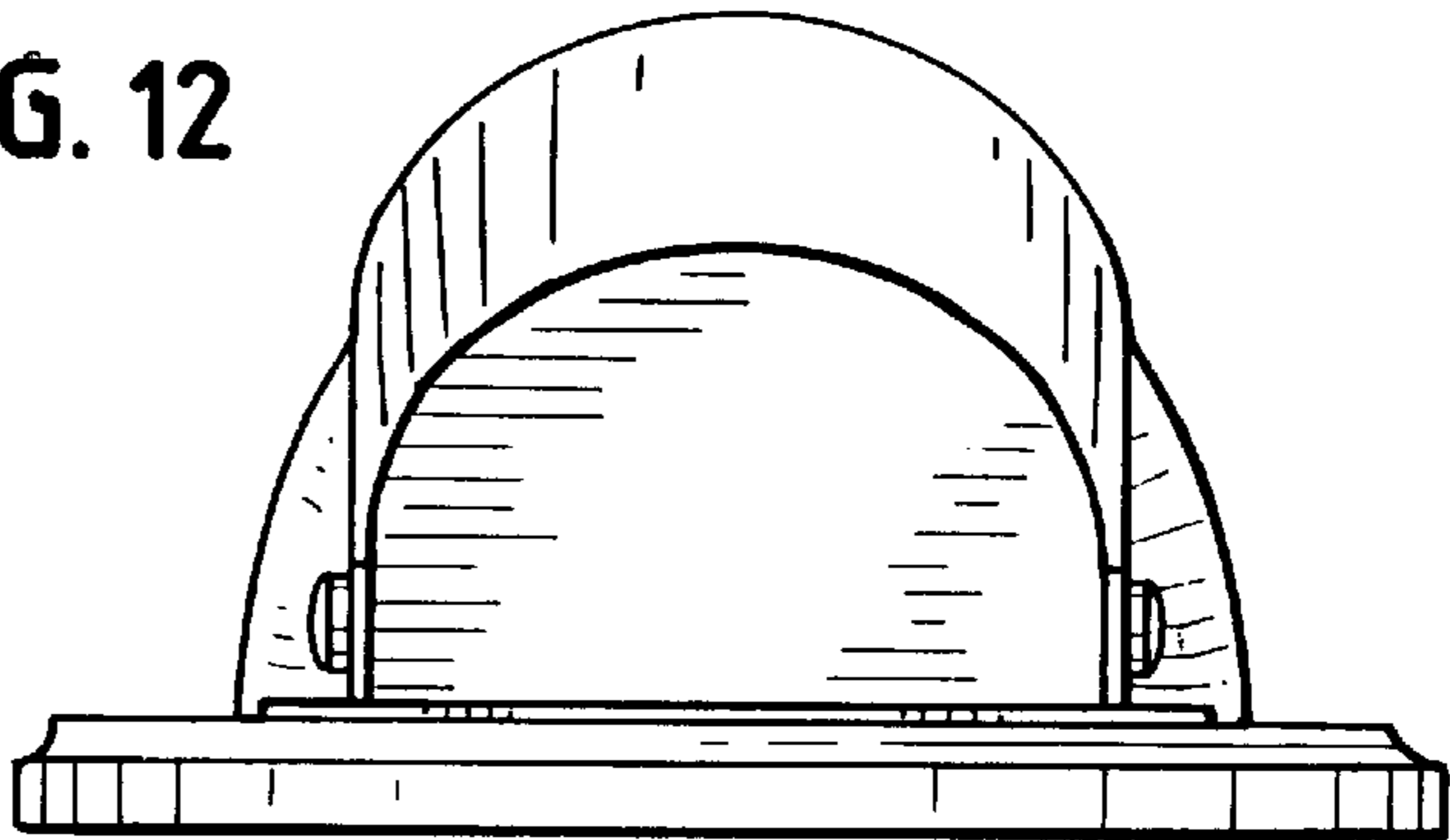

FIG. 14

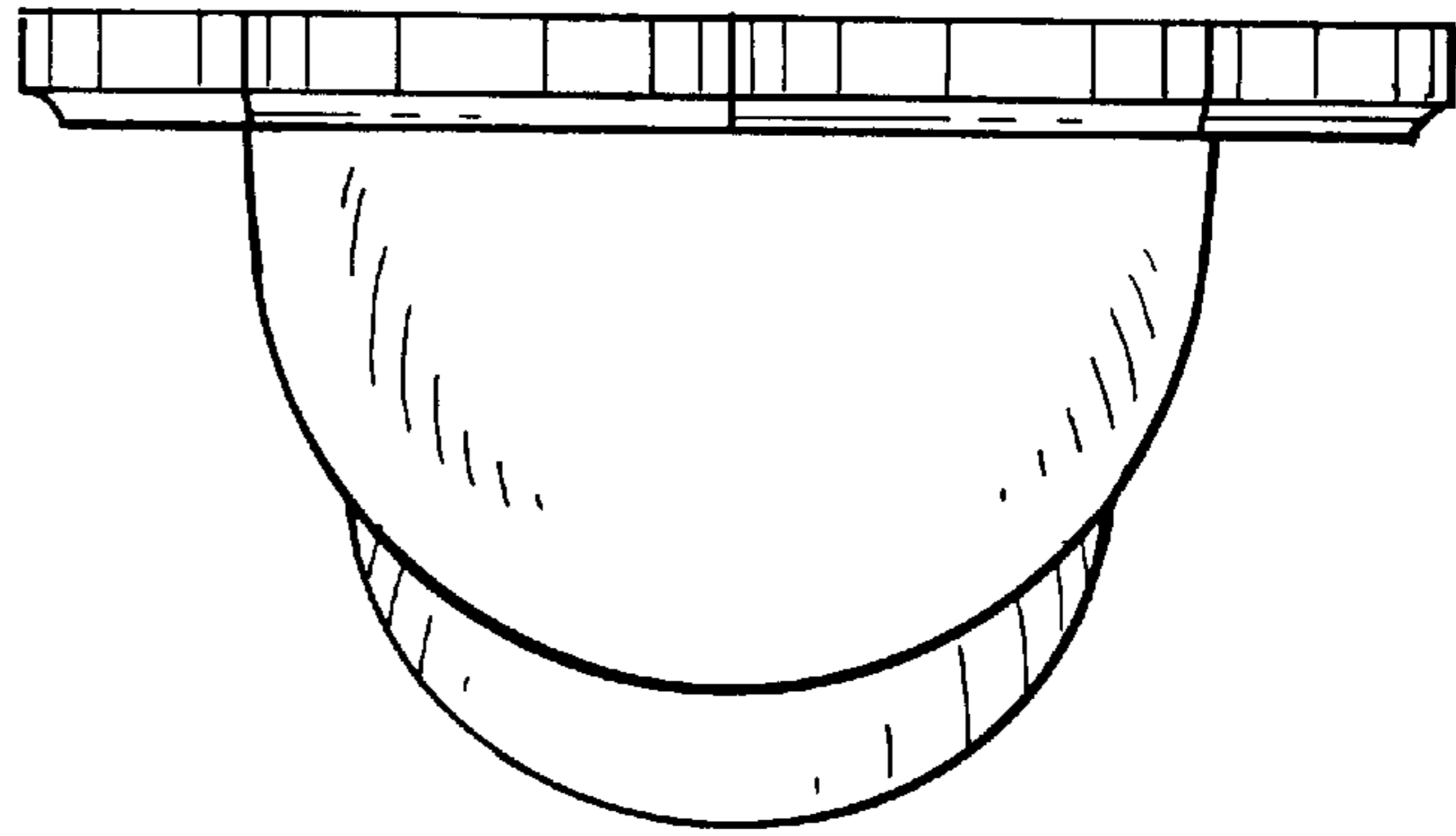

FIG. 15

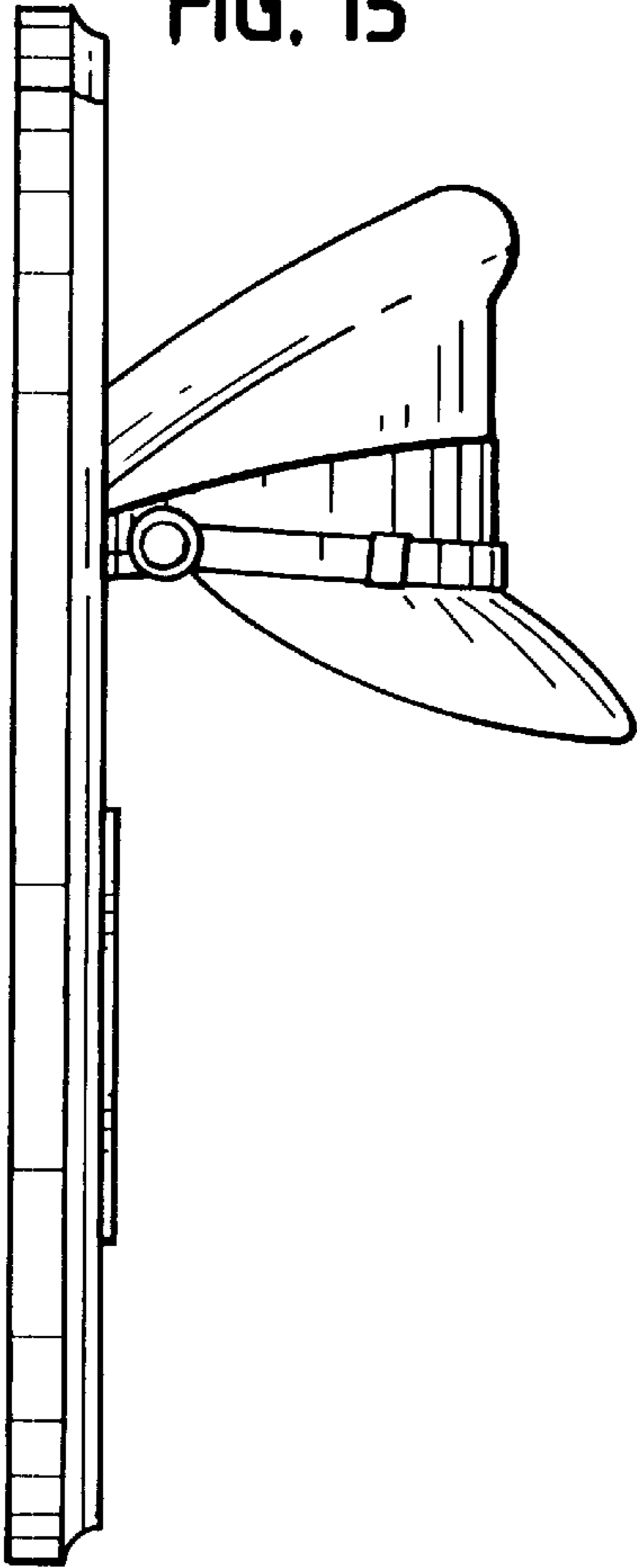

FIG. 13

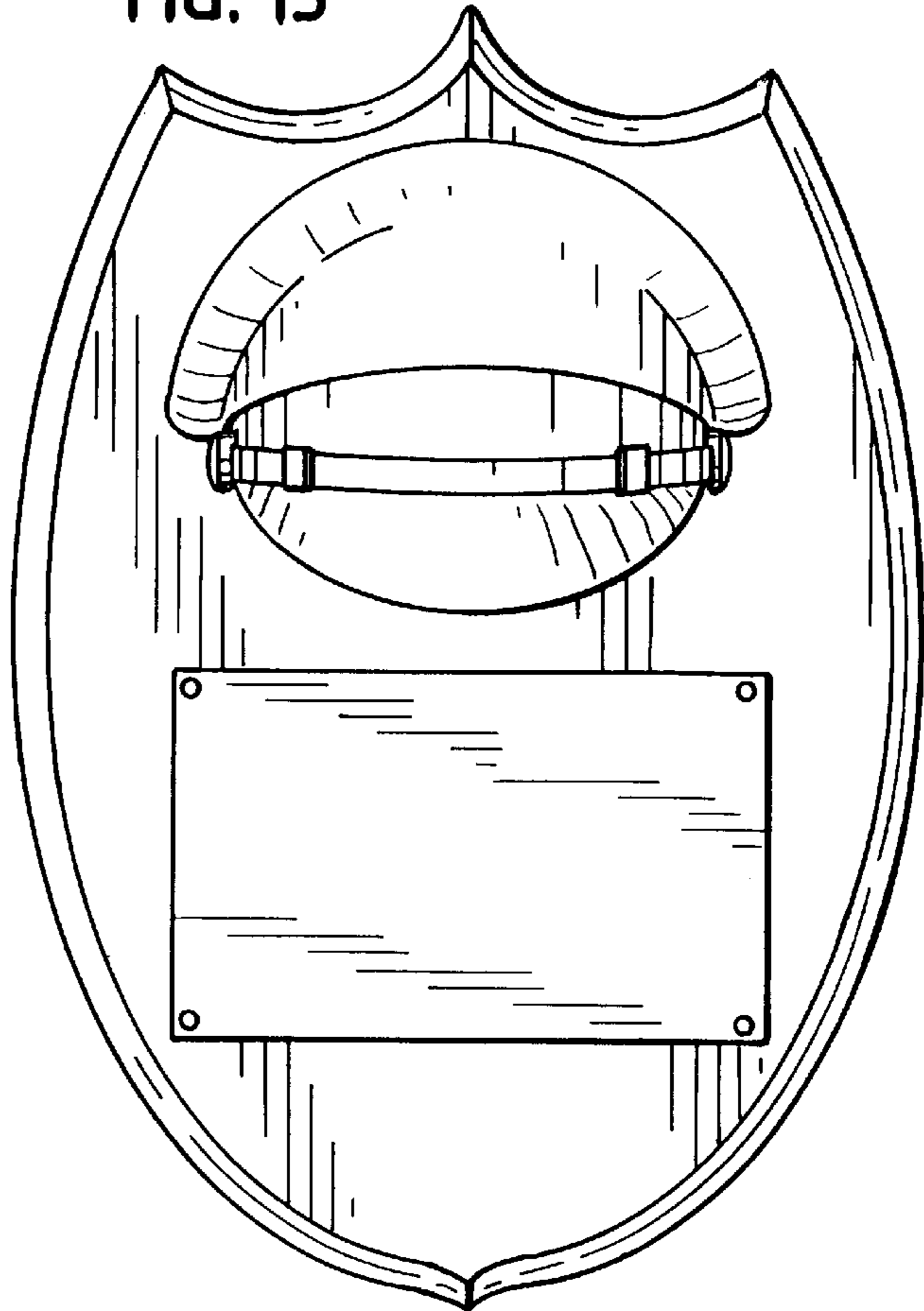

FIG. 16

