



US00D405624S

United States Patent [19]
Newhouse

[11] **Patent Number: Des. 405,624**

[45] **Date of Patent: **Feb. 16, 1999**

[54] **COMBINED DESK AND HUTCH**

[76] Inventor: **Thomas J. Newhouse**, 0-10923 2nd Ave., Grand Rapids, Mich. 49544-6753

[**] Term: **14 Years**

[21] Appl. No.: **57,059**

[22] Filed: **Jul. 15, 1996**

[51] **LOC (6) Cl. 06-03**

[52] **U.S. Cl. D6/426**

[58] **Field of Search D6/421-428; 312/194-196; 108/59, 60**

[56] **References Cited**

U.S. PATENT DOCUMENTS

D. 63,283	11/1923	Cameron	D6/426
D. 209,148	11/1967	Kegel	D6/426
D. 349,200	8/1994	Kelley	D6/427
D. 354,408	1/1995	Kelley	D6/426

OTHER PUBLICATIONS

“Woodtech 4000” by Davis Furniture Industries Inc.; desk unit on bottom of page, 1984.
 Jacobs Gardner, p. 61B; desk and hutch unit on top of page, 1988.
 K-Log Catalog p. 50; desk and hutch unit on top right of page, Oct. 29, 1994.
 Sauder Woodworking, p. 1; desk and hutch unit on bottom of page, 1995.

Primary Examiner—James Gandy
Assistant Examiner—Linda Brooks
Attorney, Agent, or Firm—Waters & Morse, PC

[57] **CLAIM**

The ornamental design for a combined desk and hutch, as shown and described.

DESCRIPTION

FIG. 1 is an elevational right side, perspective view of my new design;
 FIG. 2 is a right side perspective view thereof taken from a lower elevation;
 FIG. 3 is a rear and right side perspective view thereof;
 FIG. 4 is a front and right side perspective view thereof;
 FIG. 5 is another right side perspective view thereof;
 FIG. 6 is an enlarged right side elevational view thereof;
 FIG. 7 is a plan view thereof;
 FIG. 8 is an enlarged rear elevational view thereof;
 FIG. 9 is an enlarged fragmentary sectional view taken along line IX—IX of FIG. 8, shown broken away for convenience of illustration;
 FIG. 10 is an enlarged fragmentary elevation view of the top shelf taken along line X—X in FIG. 7; and,
 FIG. 11 is an enlarged section view of the back panel and desk top taken along line XI—XI in FIG. 8, shown broken away for convenience of illustration.

1 Claim, 5 Drawing Sheets



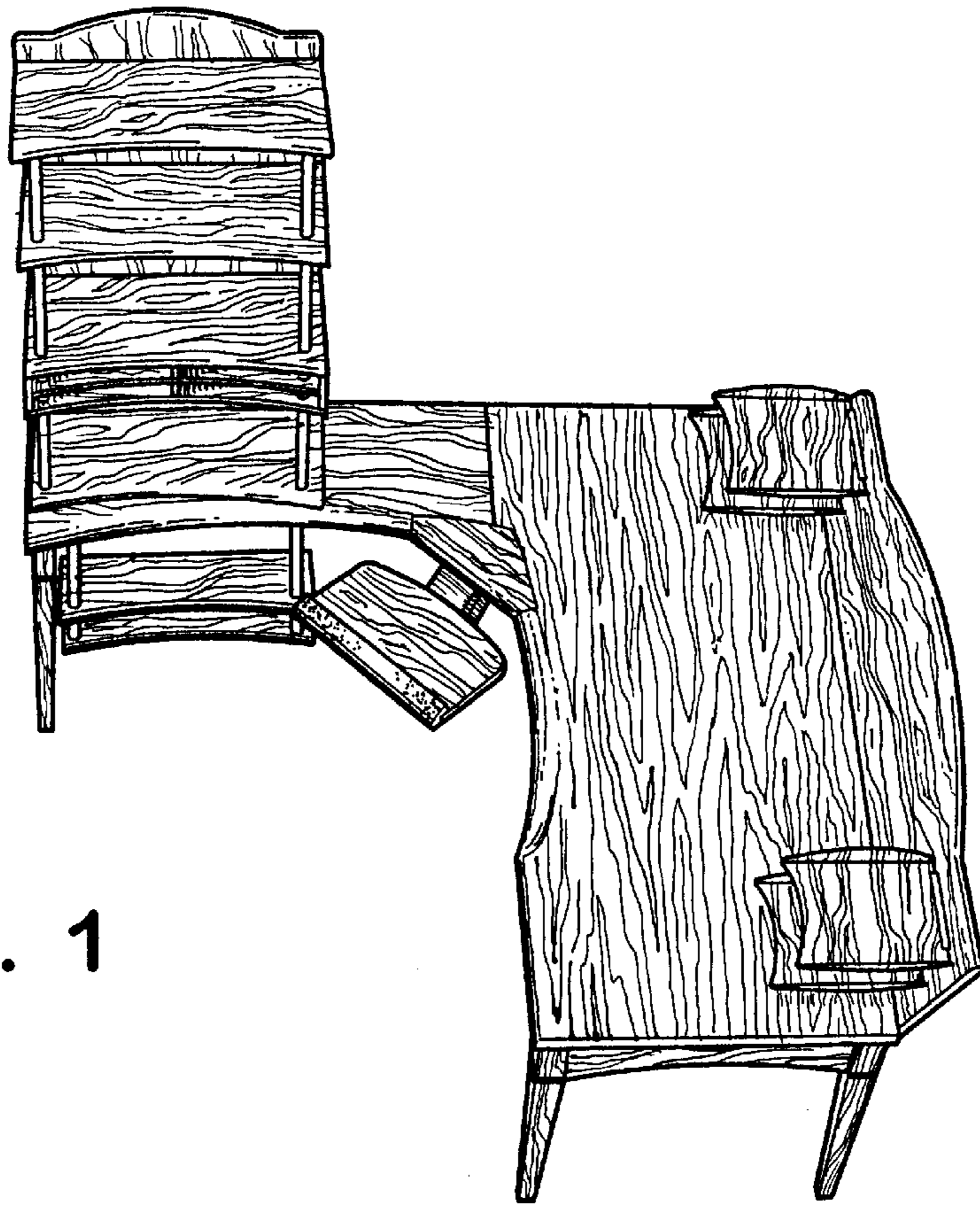

Fig. 1

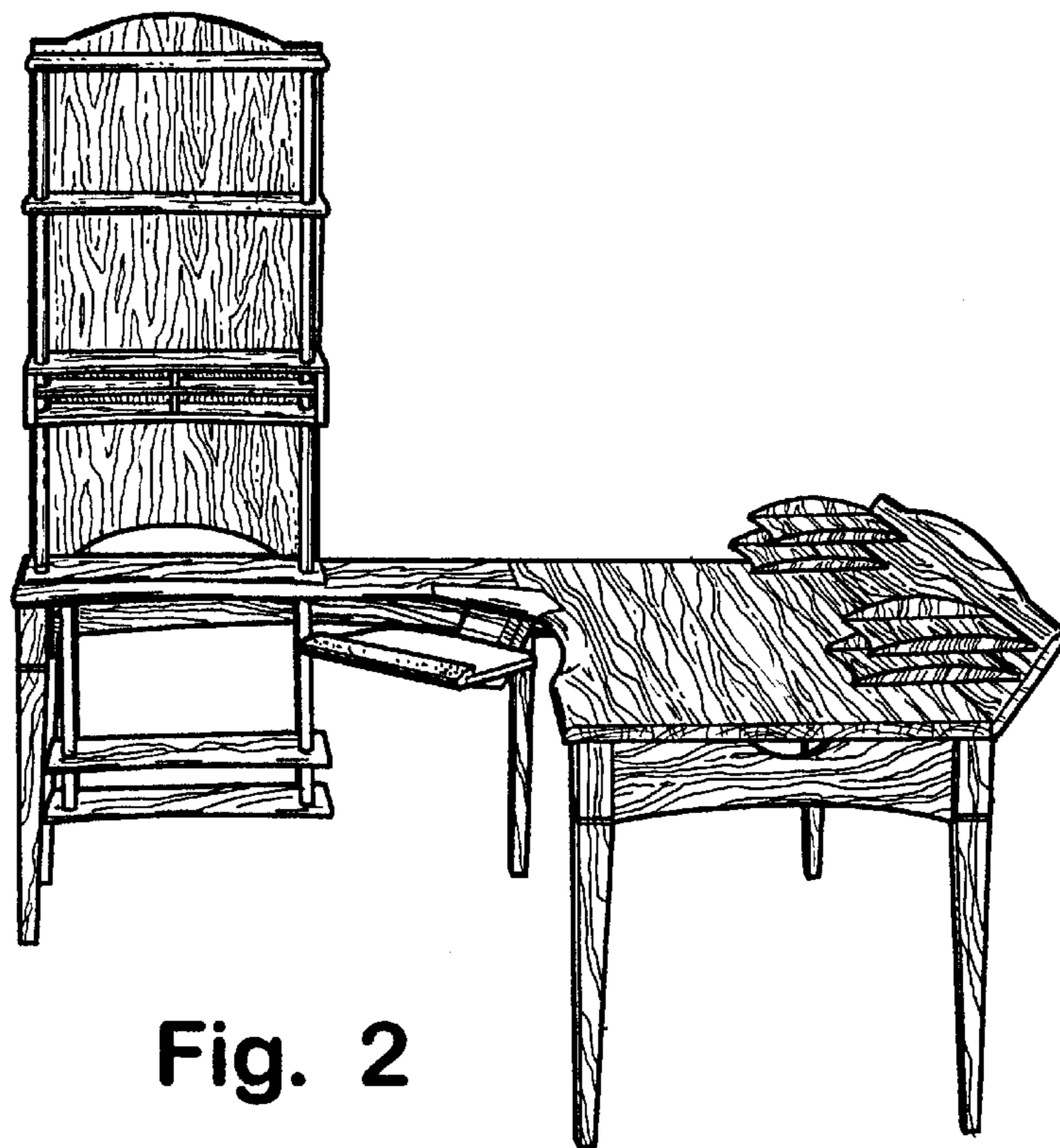

Fig. 2



Fig. 3

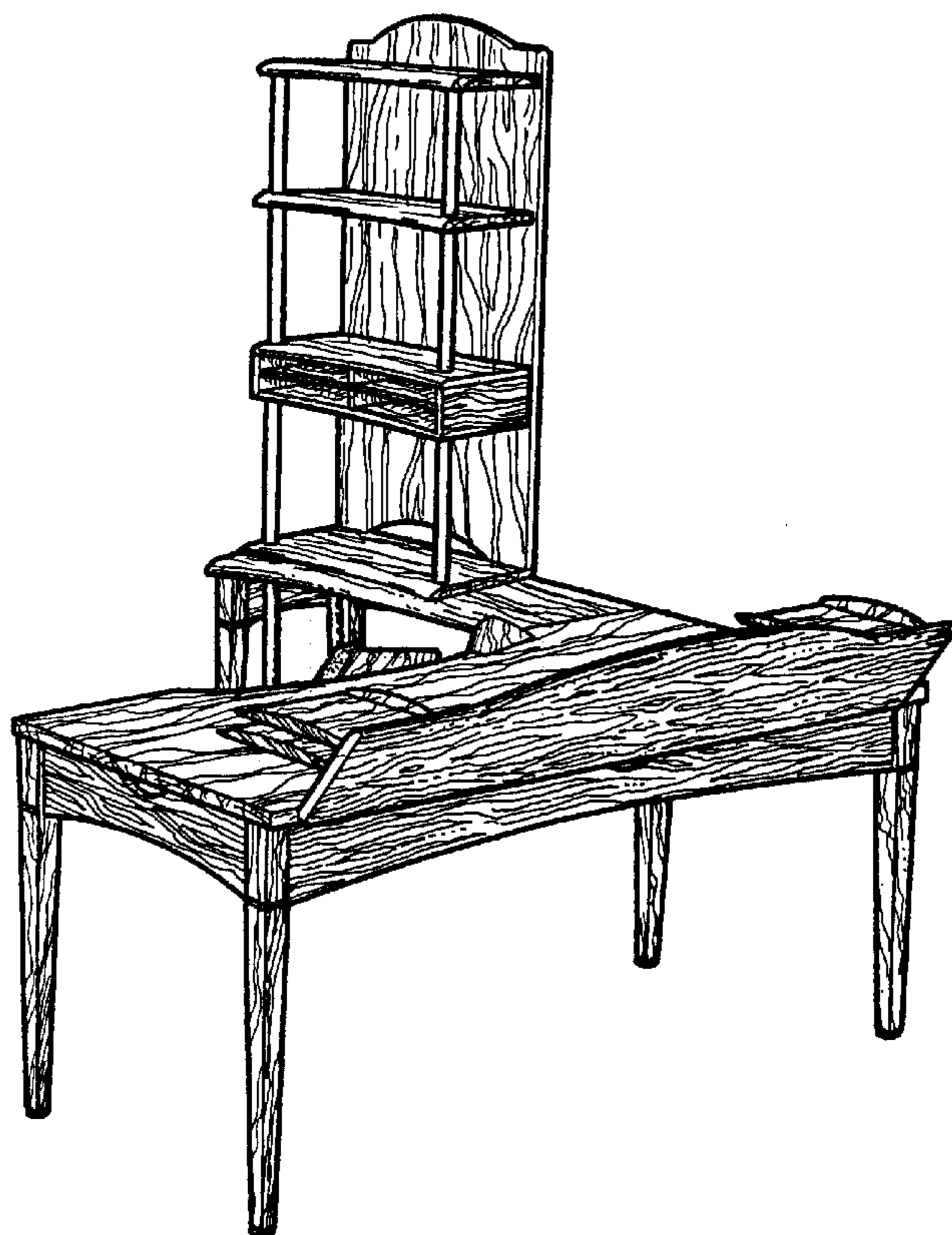

Fig. 4



Fig. 5

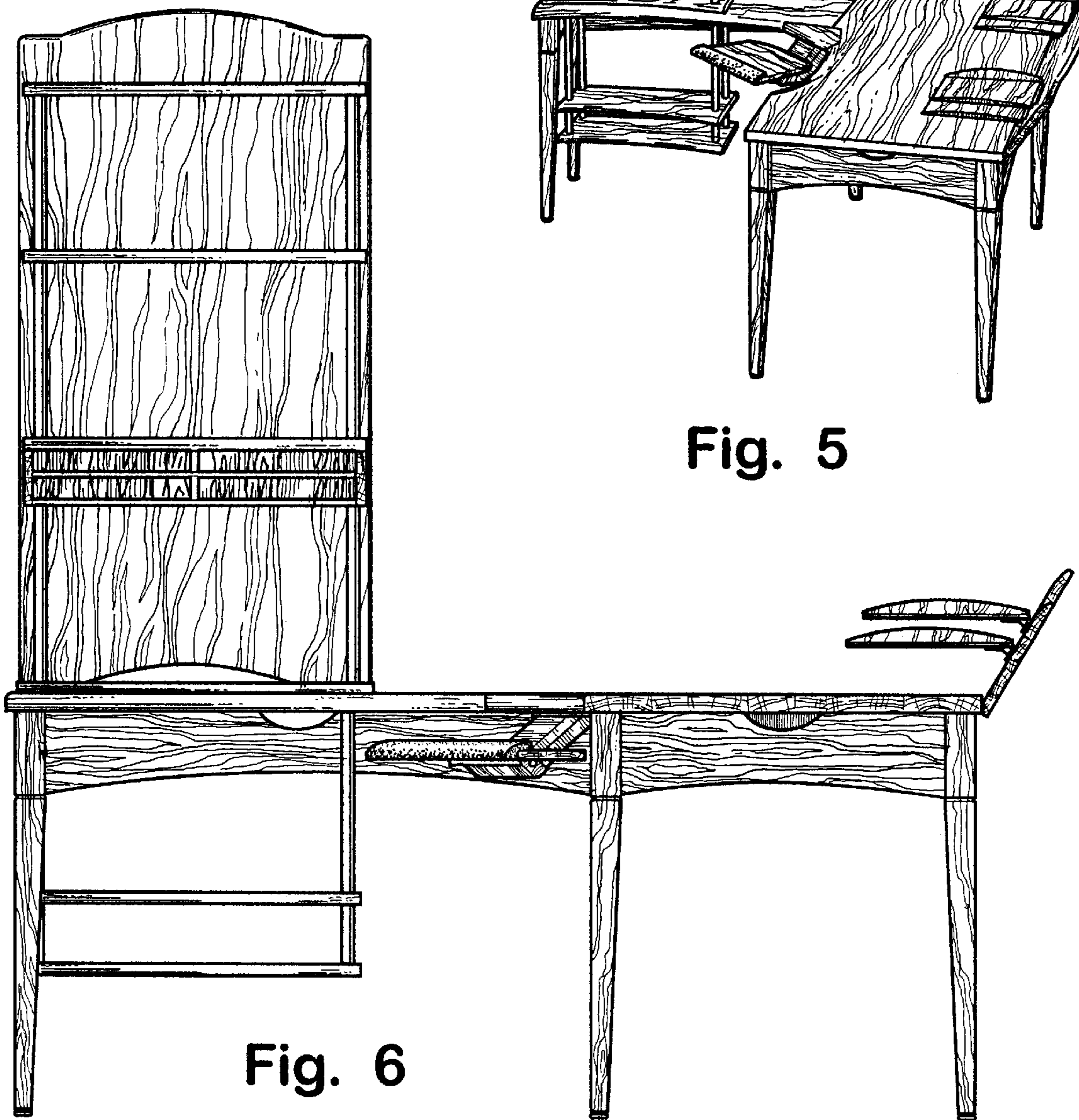

Fig. 6

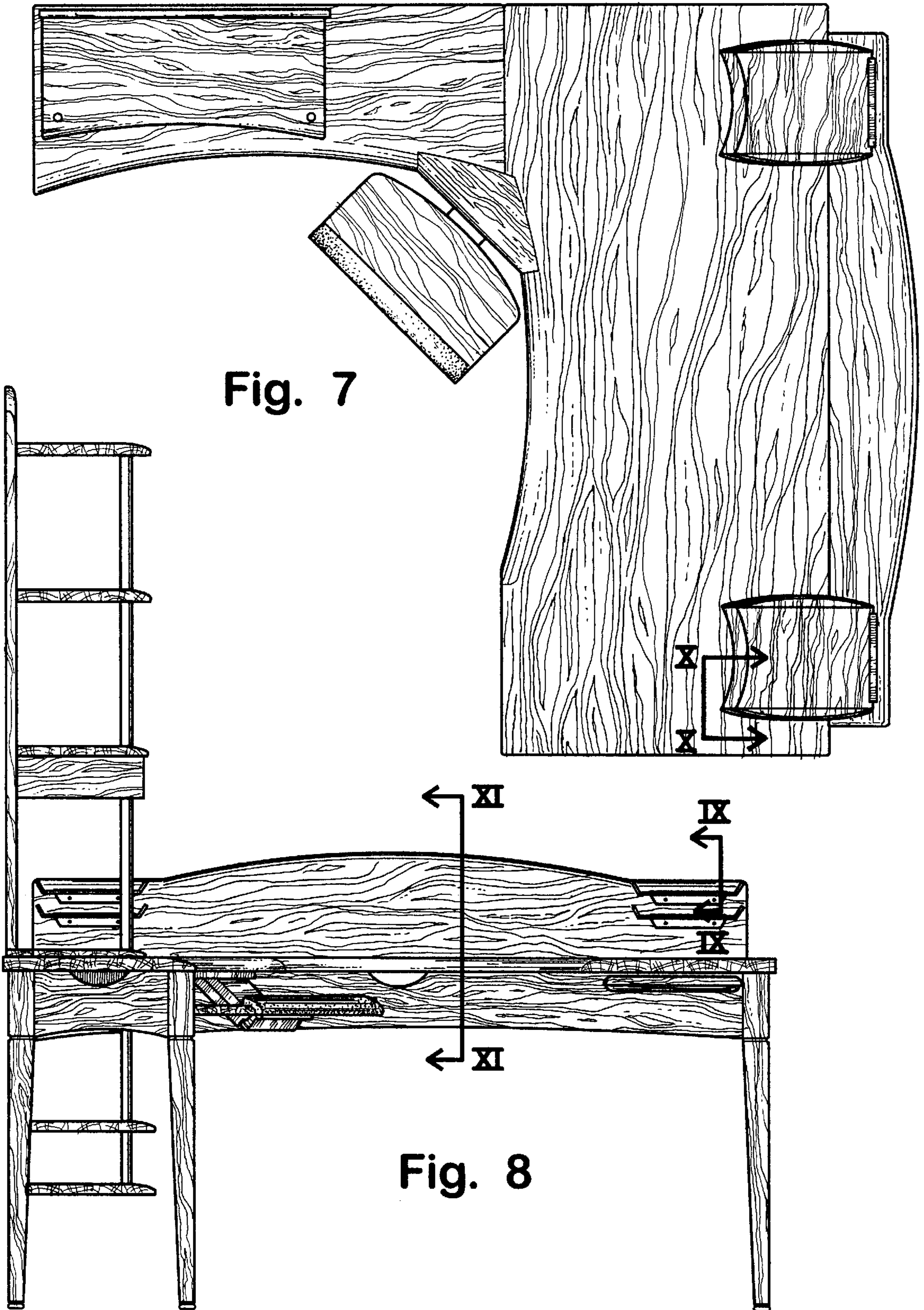

Fig. 7

Fig. 8

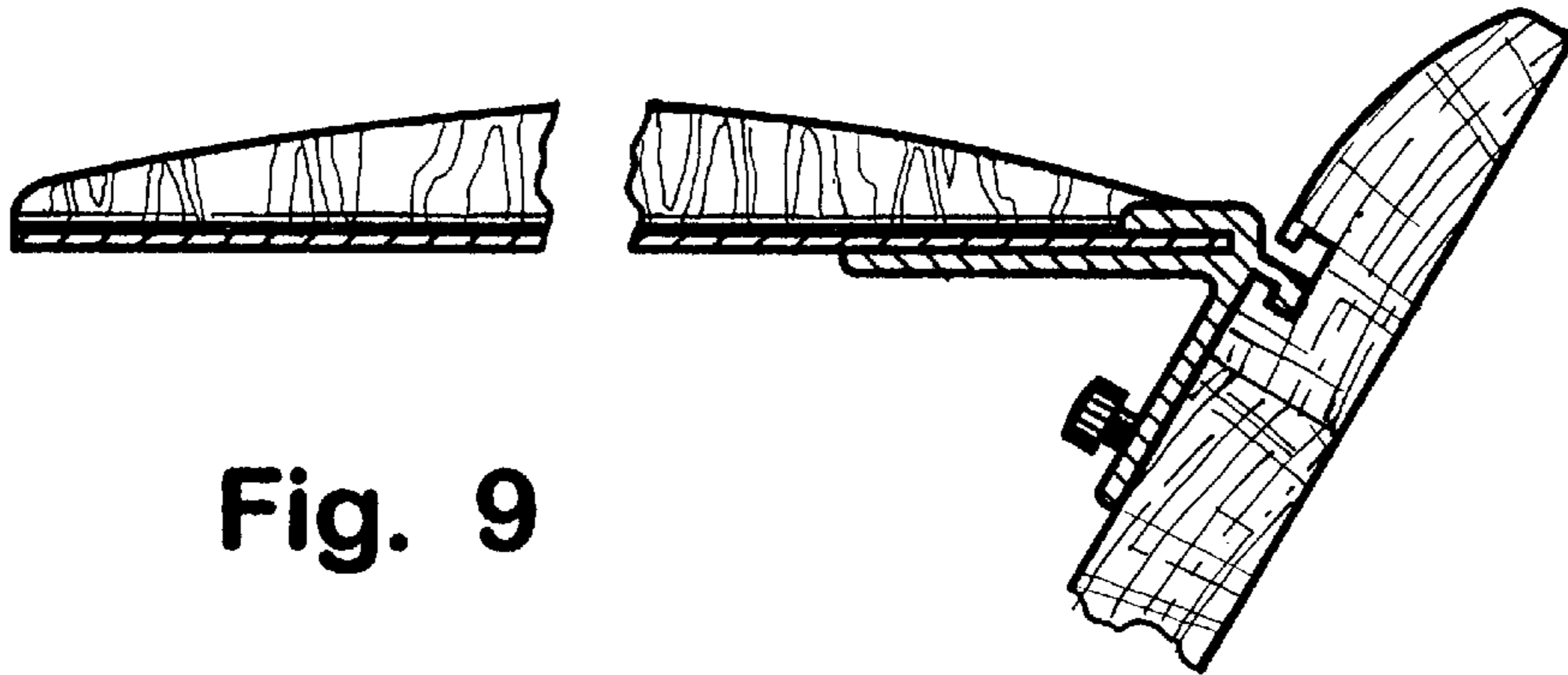

Fig. 9

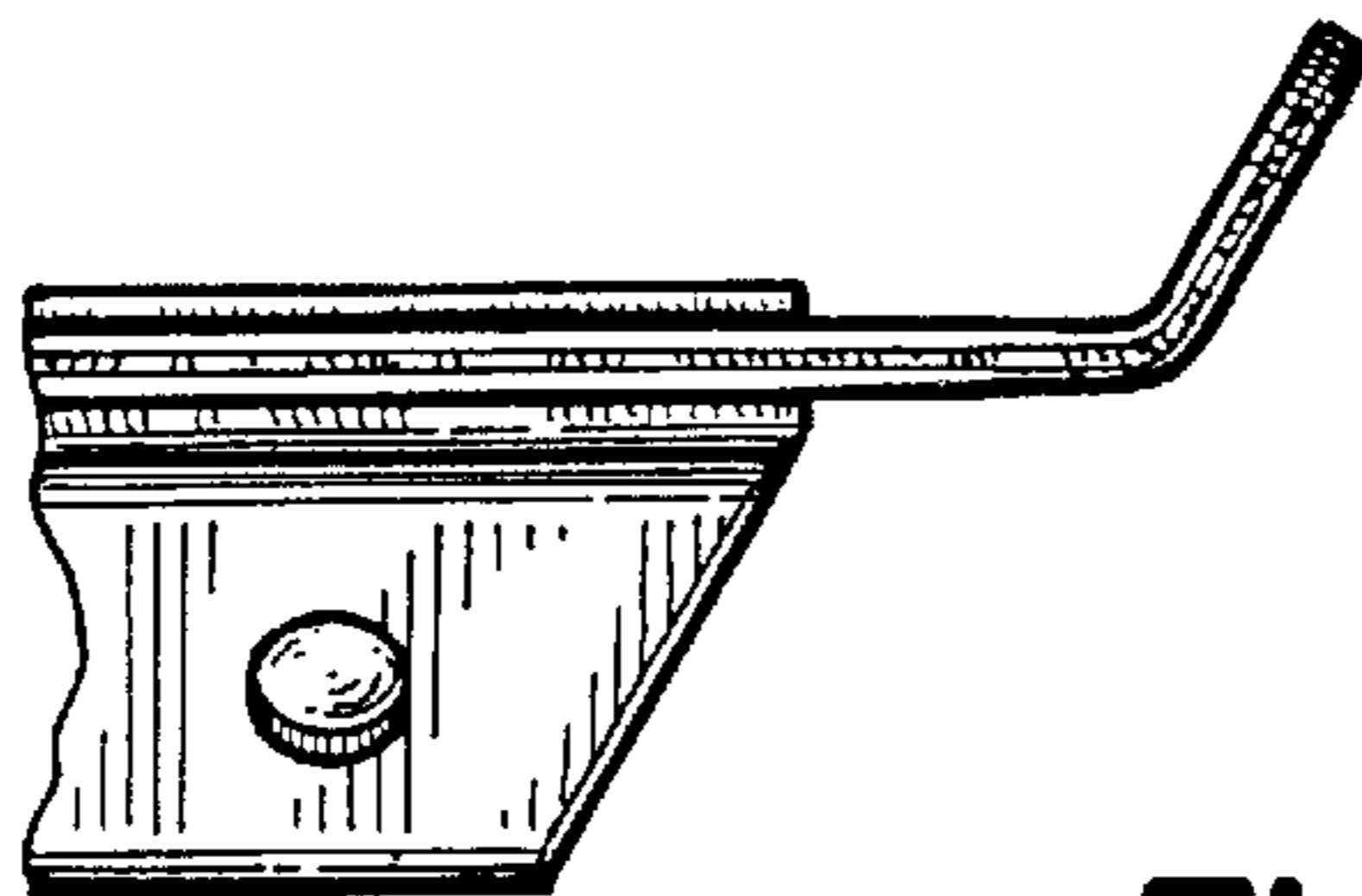

Fig. 10

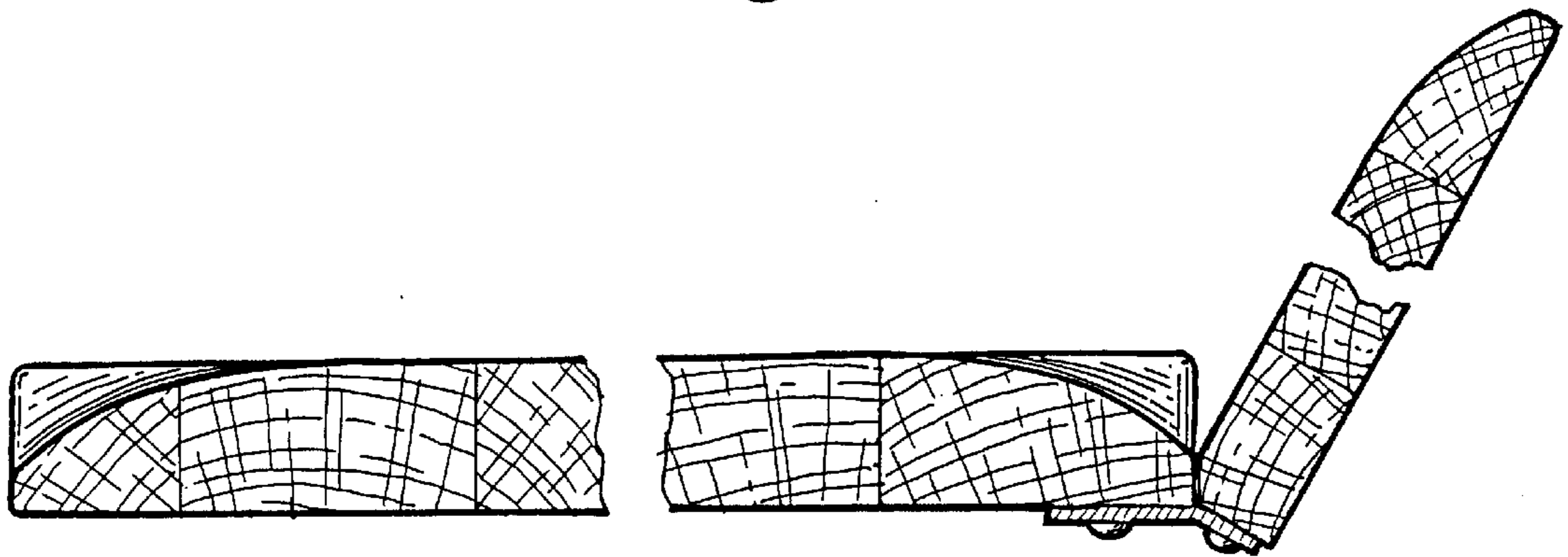

Fig. 11