



US00D405569S

United States Patent [19]

Rowley et al.

[11] **Patent Number:** **Des. 405,569**

[45] **Date of Patent:** ****Feb. 9, 1999**

[54] **UPRIGHT APPLIANCE HANDLE**

[75] Inventors: **David S. Rowley**, Powder Springs;
Edward I. Stamm, Jr., Atlanta; **Javier Verdura**, Marietta; **Maureen Carroll**;
Steven Gamper, both of Atlanta, all of Ga.

[73] Assignee: **Matsushita Home Appliance Corporation of America**, Danville, Ky.

[**] Term: **14 Years**

[21] Appl. No.: **80,208**

[22] Filed: **Dec. 3, 1997**

[51] **LOC (6) Cl.** **15-05**

[52] **U.S. Cl.** **D32/25; D32/22**

[58] **Field of Search** **D32/21-25, 31;**
15/320-325, 353, 340.2, 327.1, 327.2, 327.5,
327.6, 327.7

[56] **References Cited**

U.S. PATENT DOCUMENTS

D. 219,235 11/1970 Schucker D32/22

D. 238,849 2/1976 Jones D32/22
D. 253,471 11/1979 Bothun et al. D32/22
D. 277,517 2/1985 Wiese et al. D32/22
D. 381,779 7/1997 Prichett et al. D32/21

Primary Examiner—Raphael Barkai
Assistant Examiner—Mitchell I. Siegel
Attorney, Agent, or Firm—King & Schickli

[57] **CLAIM**

The ornamental design of an upright appliance handle, as shown and described.

DESCRIPTION

FIG. 1 is a perspective view of the upright appliance handle of the present invention;
FIG. 2 is a front side elevational view thereof;
FIG. 3 is a left side elevational view, the right side being a substantial mirror image thereof;
FIG. 4 is a rear elevational view thereof;
FIG. 5 is a bottom plan view thereof; and,
FIG. 6 is a top plan view thereof.

The broken line showing of the upright appliance is for illustrative purposes only and forms no part of the claimed design.

1 Claim, 4 Drawing Sheets

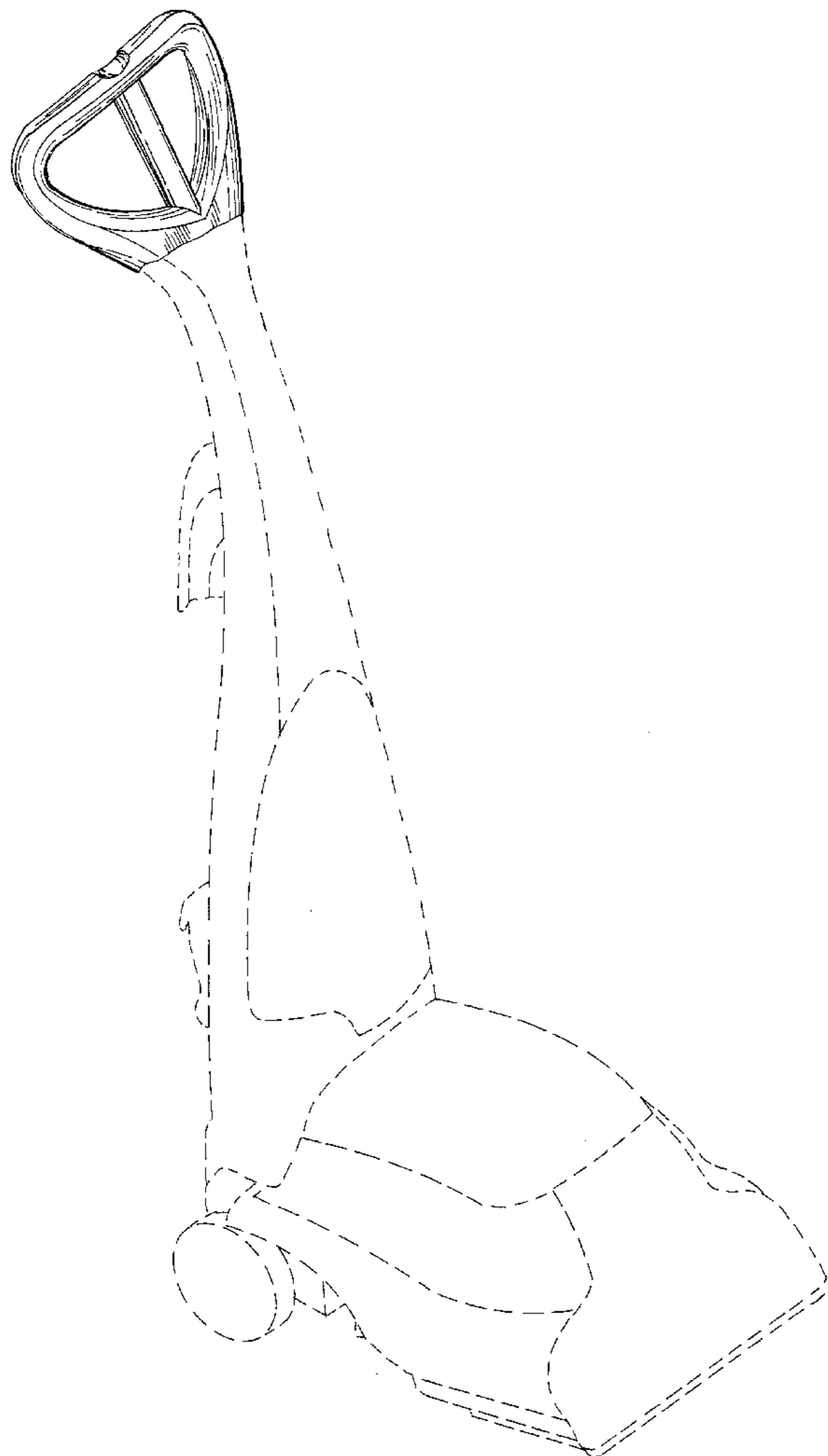

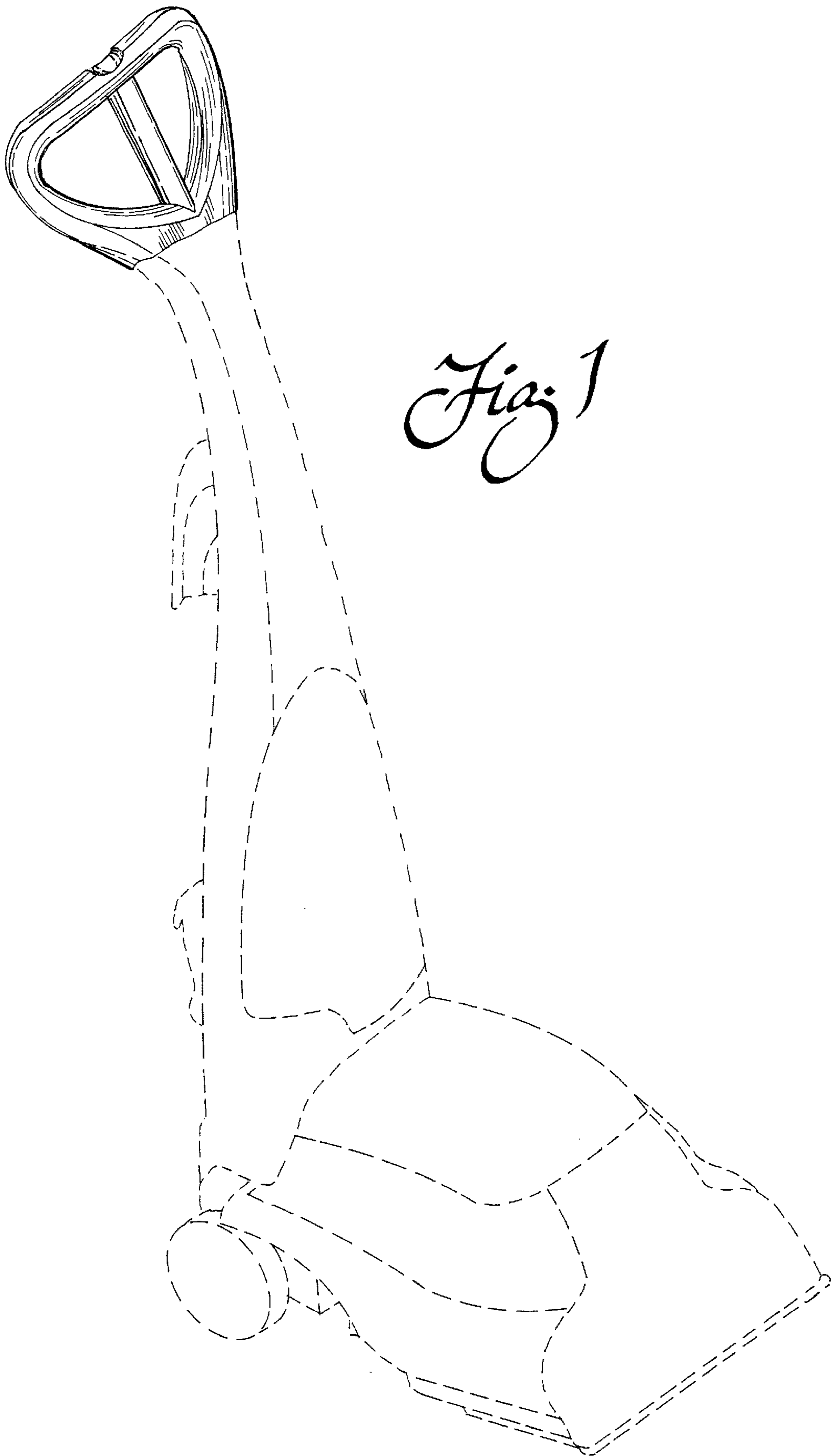

Fig. 1

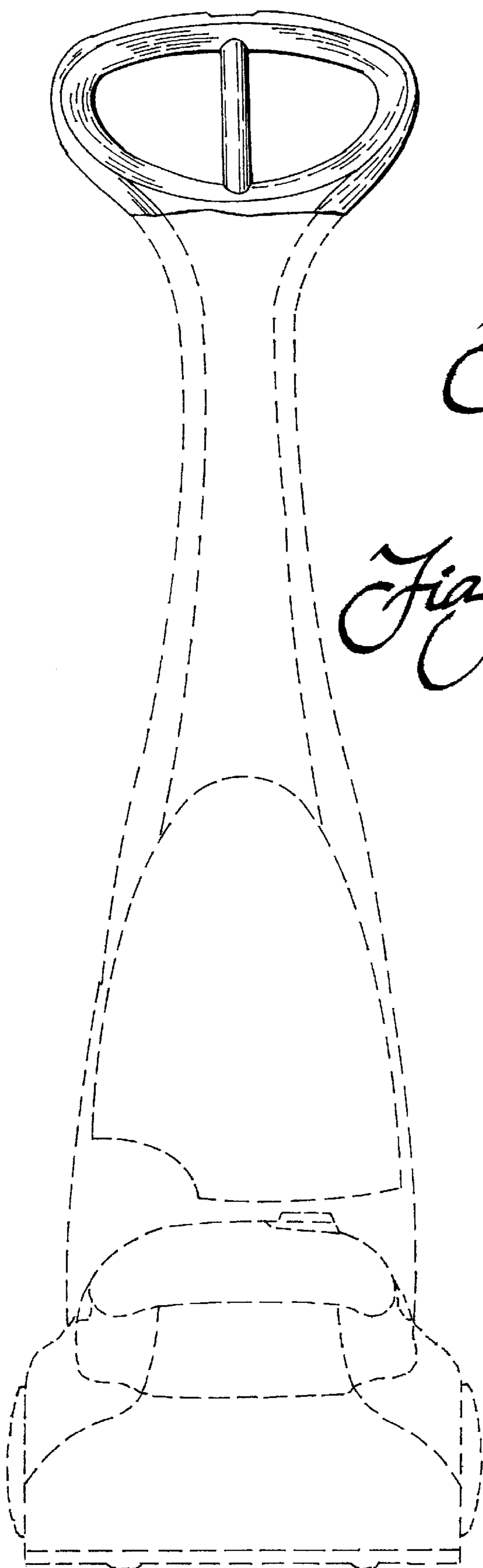

Fig. 2

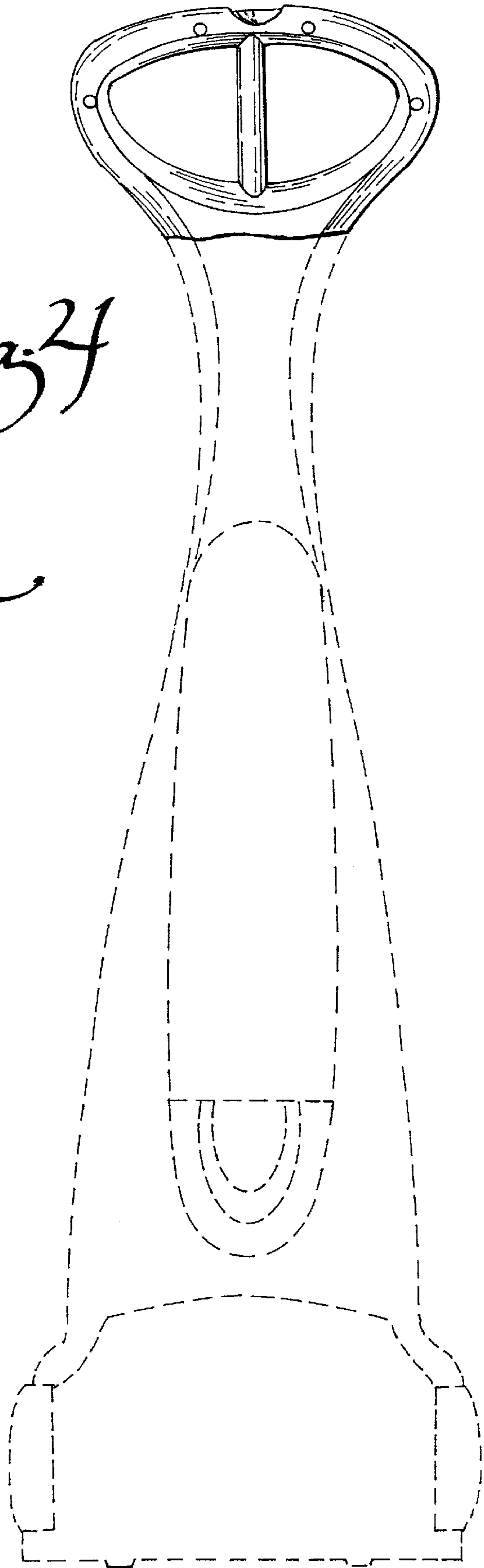

Fig. 3

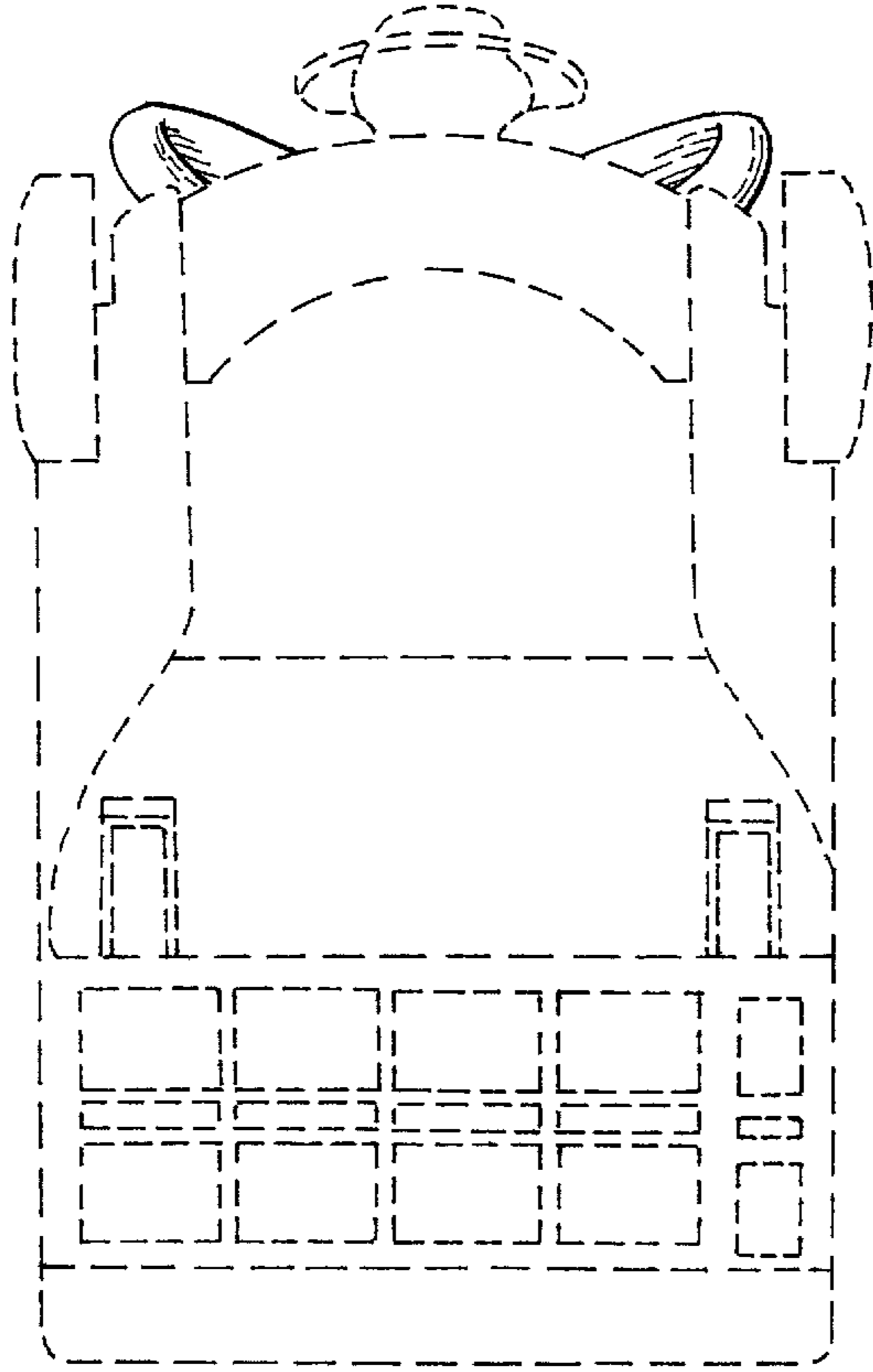
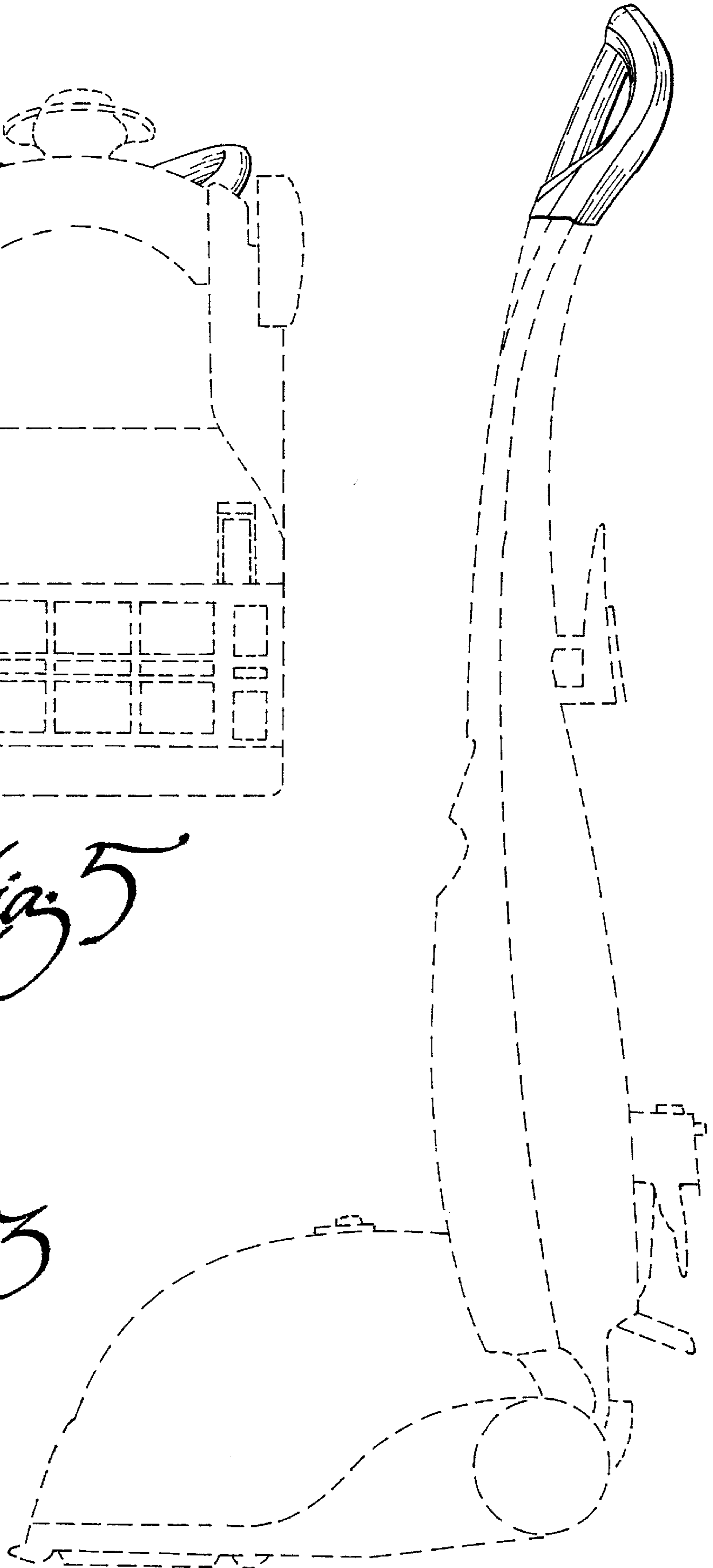

Fig 5

Fig 3



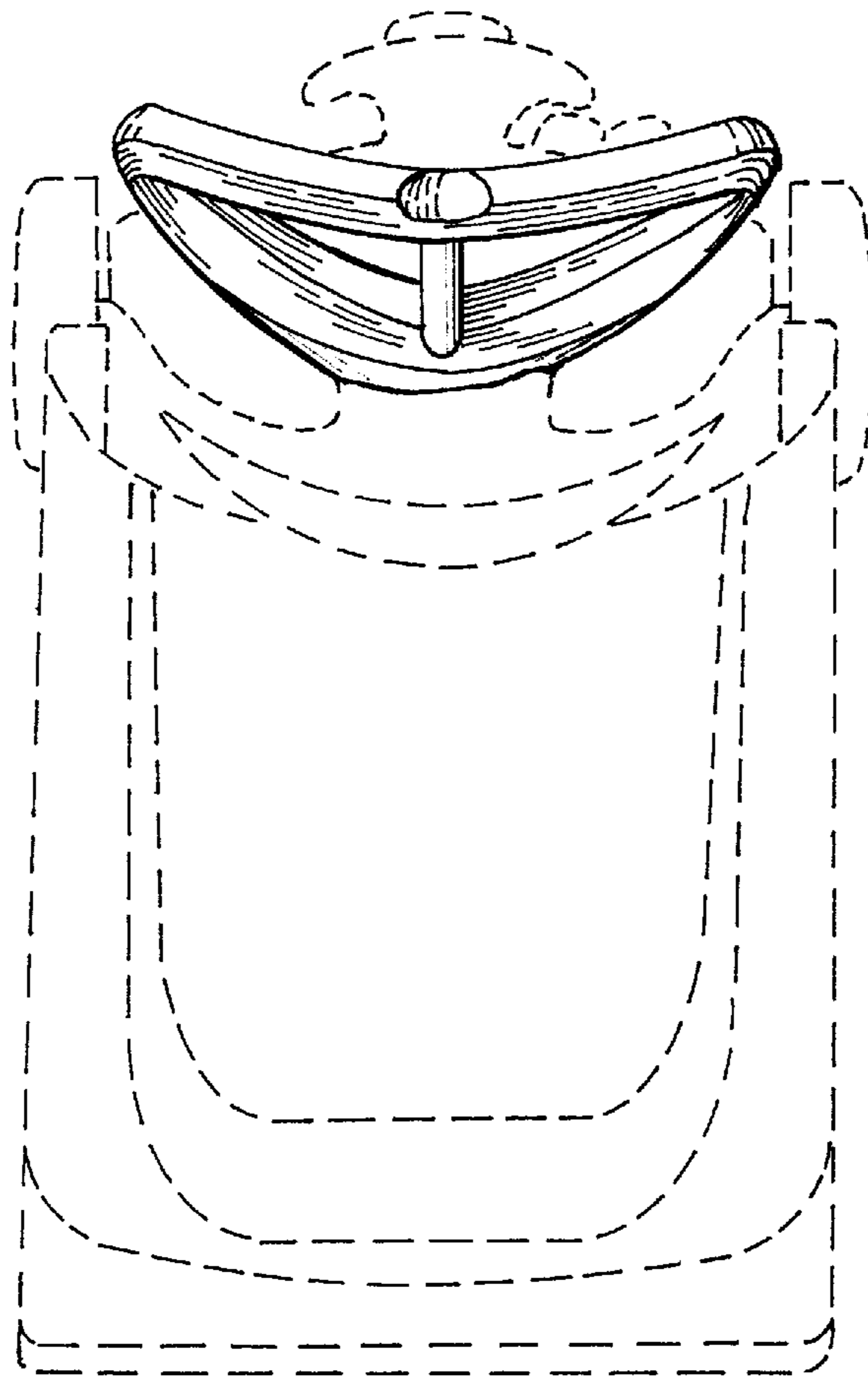

Fig 6