



US00D405557S

**United States Patent** [19]  
**Lindsay**

[11] **Patent Number: Des. 405,557**

[45] **Date of Patent: \*\*Feb. 9, 1999**

[54] **BOTTLE OPENER FINGER PROTECTOR**

[76] Inventor: **Arlene Lindsay**, R.R. #1, Georgetown,  
Ontario, Canada, L7G 4S4

[\*\*] Term: **14 Years**

[21] Appl. No.: **81,028**

[22] Filed: **Dec. 22, 1997**

[51] **LOC (6) Cl. .... 29-02**

[52] **U.S. Cl. .... D29/114**

[58] **Field of Search .... D29/113-114,**  
D29/117, 118, 122-123; D2/617, 619; 2/16,  
160, 161.1-161.5, 161.7, 162, 163, 168,  
21

[56] **References Cited**

**U.S. PATENT DOCUMENTS**

D. 168,689	1/1953	Jones	.....	D29/114
D. 170,260	8/1953	Jones	.....	D29/114
D. 335,938	5/1993	Kam	.....	D29/20
D. 364,007	11/1995	McLaren et al.	.....	D29/114
D. 373,225	8/1996	Theroux et al.	.....	D29/114
D. 373,656	9/1996	Sorrels	.....	D29/114

1,404,906	1/1922	Strahl .	
2,072,683	3/1937	Niedorff	..... 128/77
4,899,737	2/1990	Lazarian	..... 128/87 A
4,972,857	11/1990	Stewart et al.	..... 132/73

*Primary Examiner*—Ruth McInroy  
*Attorney, Agent, or Firm*—Eugene J. A. Gierczak

[57] **CLAIM**

The ornamental design for the bottle opener finger protector,  
as shown and described.

**DESCRIPTION**

FIG. 1 is a top plan view of a bottle opener finger protector  
showing my new design;  
FIG. 2 is a side elevational view thereof;  
FIG. 3 is a bottom plan view thereof;  
FIG. 4 is a end elevational view thereof;  
FIG. 5 is a enlarged perspective view thereof;  
FIG. 6 is a perspective view thereof in an operative position;  
FIG. 7 is a perspective view thereof in an operative position;  
and,  
FIG. 8 is a perspective view thereof in an operative position.

**1 Claim, 3 Drawing Sheets**

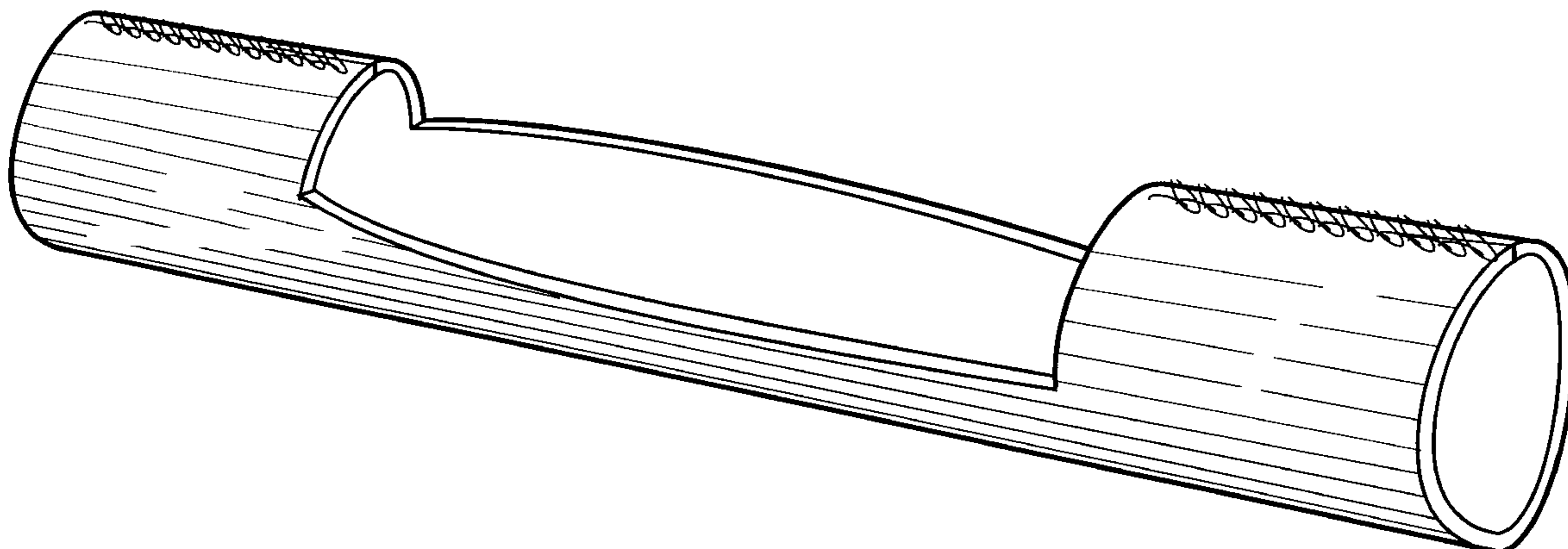

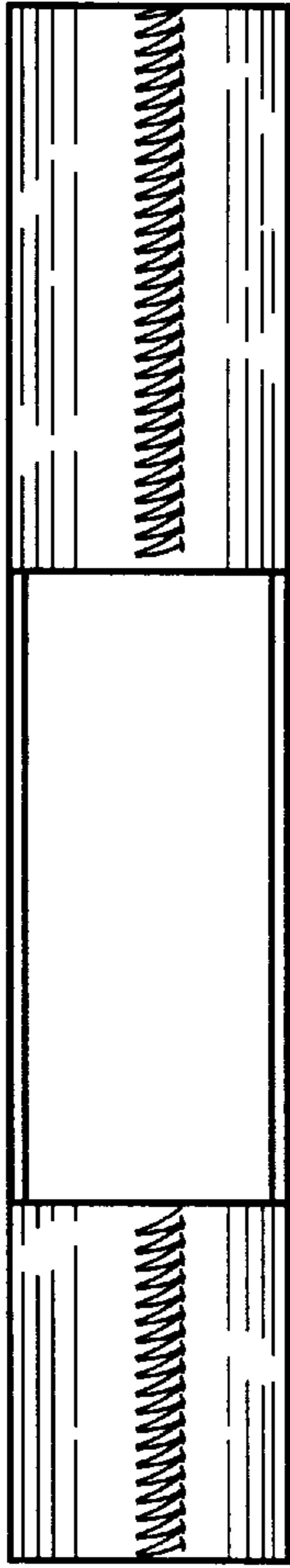

Fig. 1

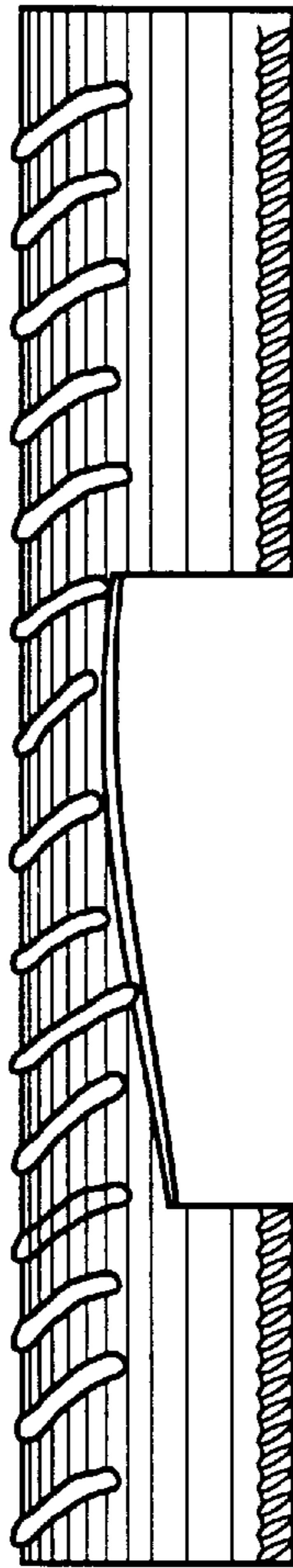

Fig. 2

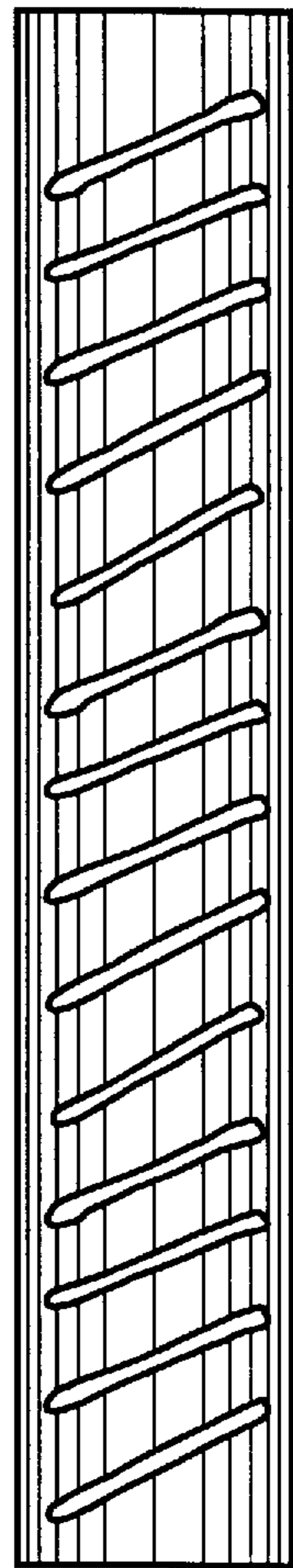

Fig. 3

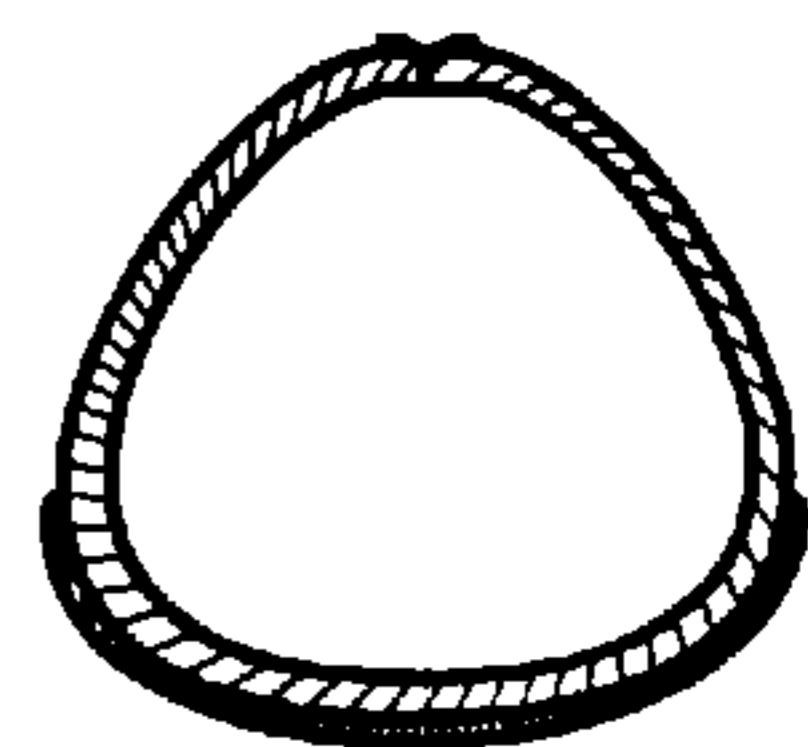

Fig. 4

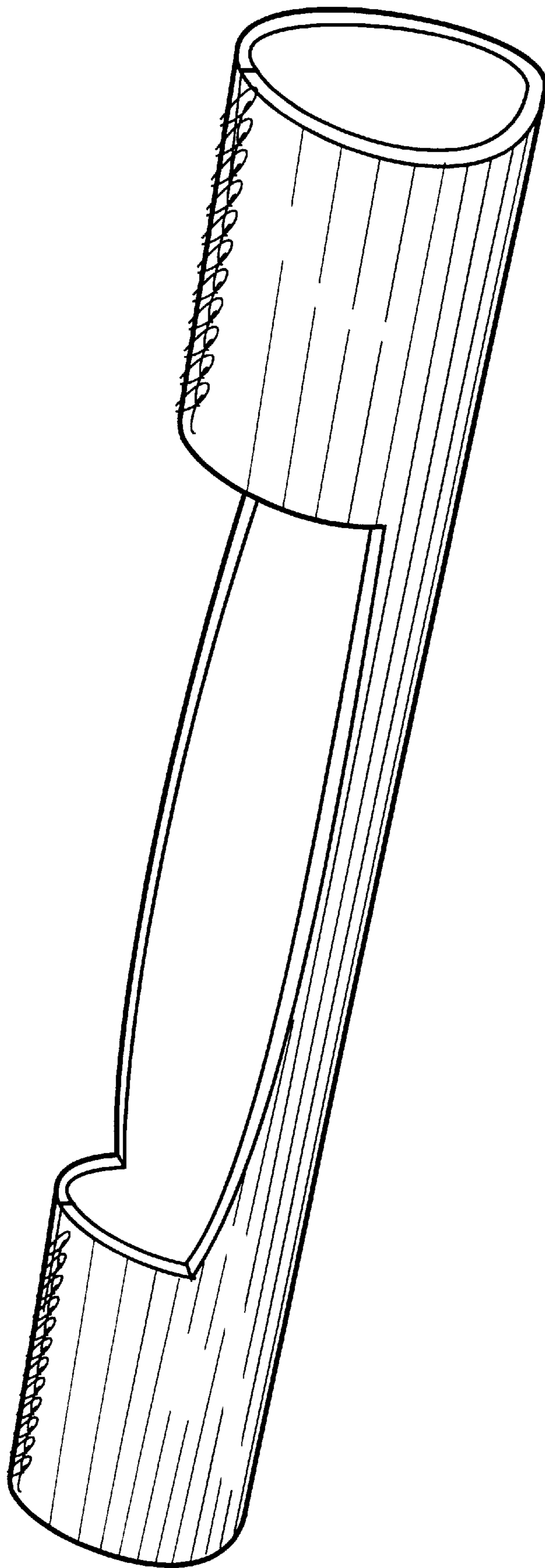

Figure 5

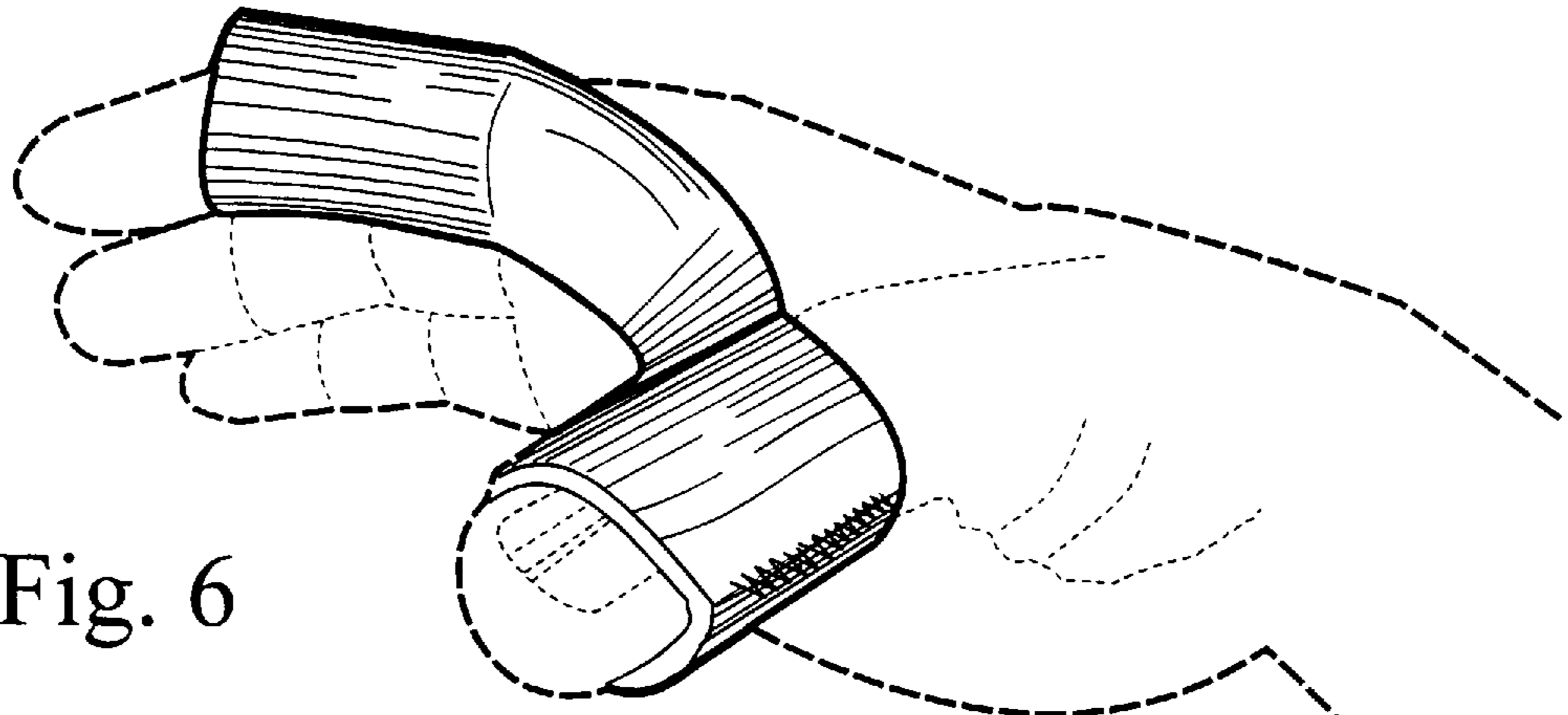

Fig. 6

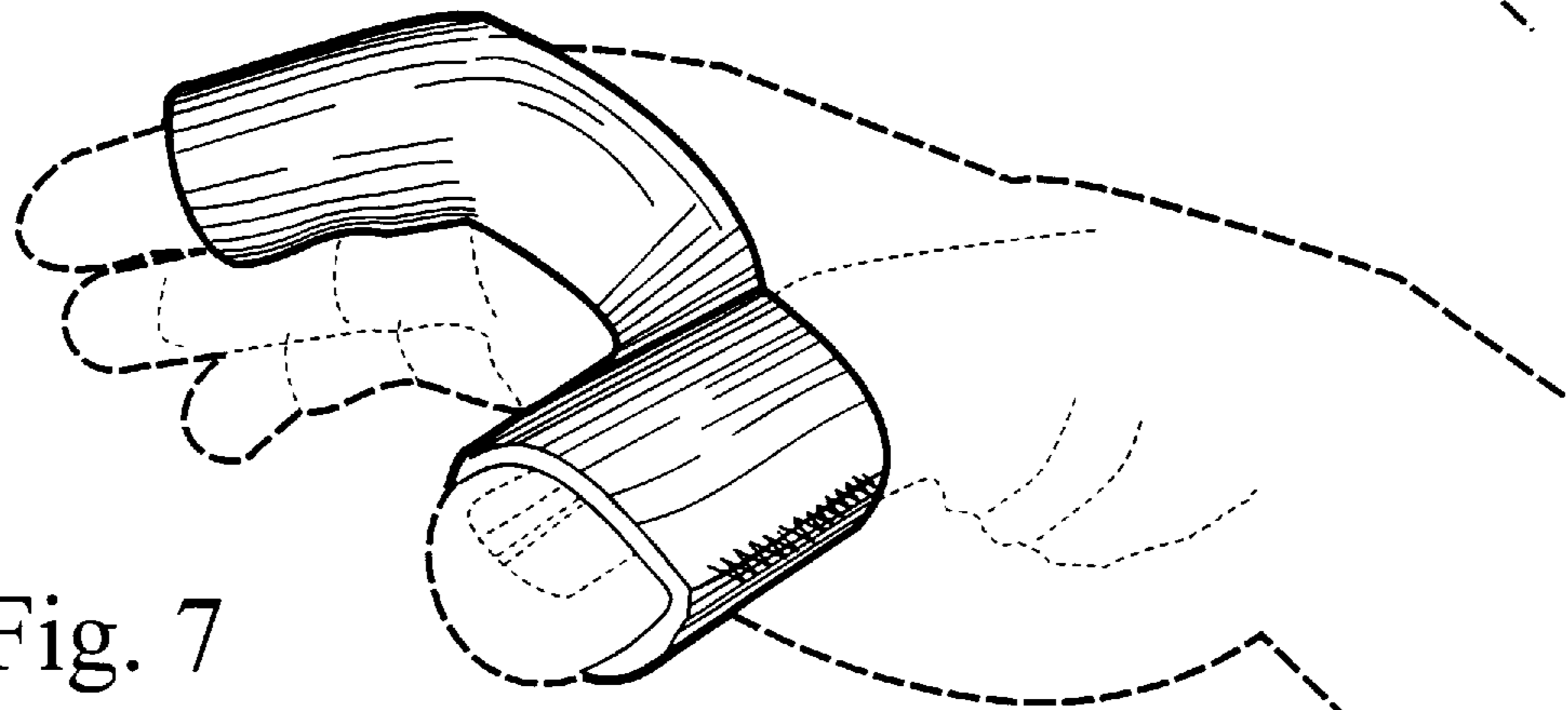

Fig. 7

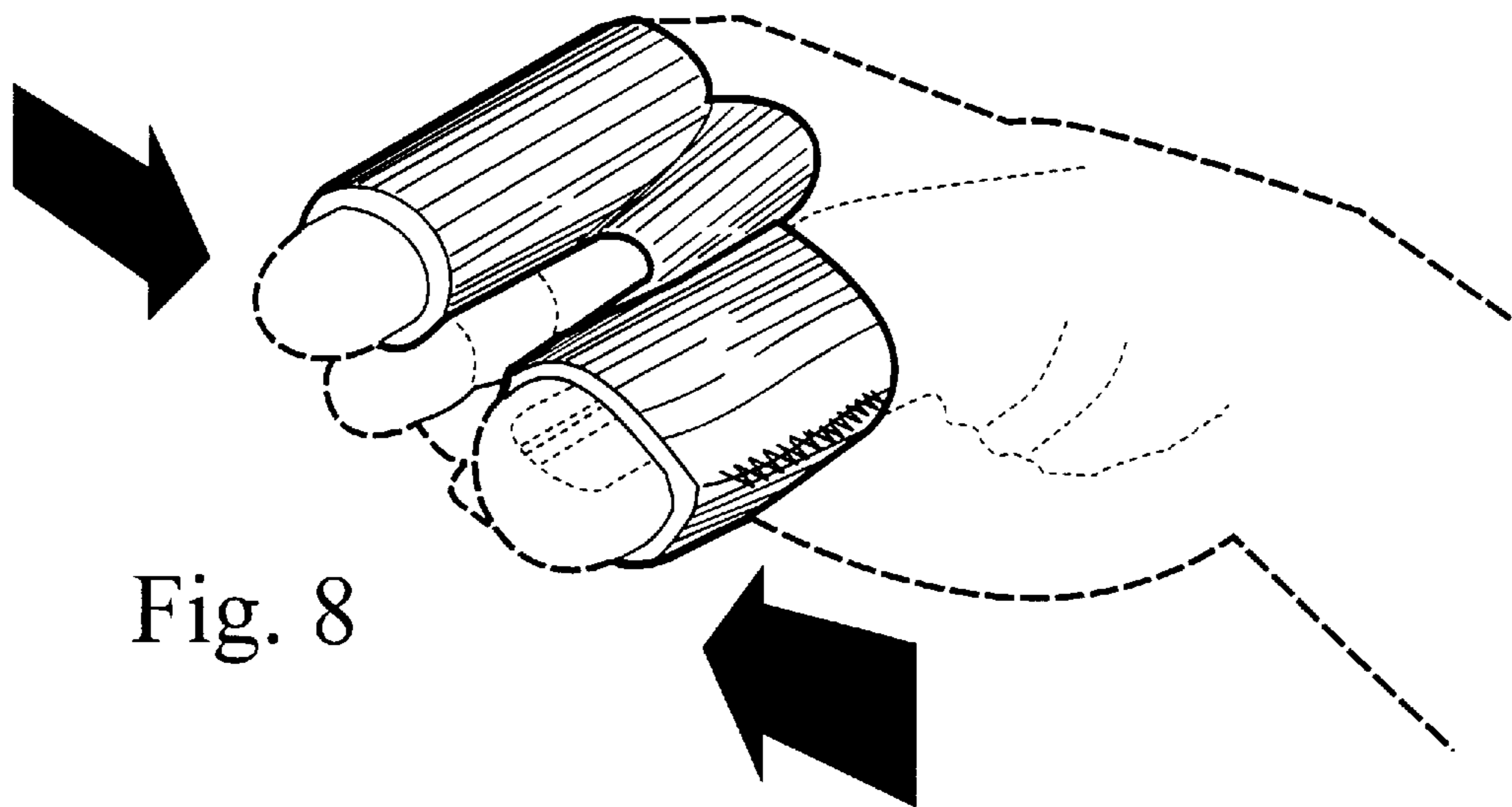

Fig. 8