



US00D405462S

**United States Patent** [19]  
**Coe**

[11] **Patent Number:** **Des. 405,462**

[45] **Date of Patent:** **\*\*Feb. 9, 1999**

[54] **CALCULATOR**

[75] Inventor: **Matthew Coe**, Asbury, N.J.

[73] Assignee: **PharmaDesign, Inc.**, Warren, N.J.

[\*\*] Term: **14 Years**

[21] Appl. No.: **77,253**

[22] Filed: **Sep. 15, 1997**

[51] **LOC (6) Cl.** ..... **18-01**

[52] **U.S. Cl.** ..... **D18/6**

[58] **Field of Search** ..... D18/1, 2, 6, 7,  
D18/11; D14/100, 105; 364/706-710; D19/59,  
60

[56] **References Cited**

**U.S. PATENT DOCUMENTS**

D. 396,700 8/1998 Butts et al. .... D14/105

*Primary Examiner*—Caron D. Veynar

*Attorney, Agent, or Firm*—Bryan, Levitin & Bab, LLP

[57] **CLAIM**

The ornamental design for a calculator, shown and described.

**DESCRIPTION**

FIG. 1 is a top plan view of a calculator showing our new design;

FIG. 2 is a front elevation view thereof;

FIG. 3 is a left side elevation view thereof;

FIG. 4 is a right side elevation view thereof;

FIG. 5 is a bottom plan view thereof;

FIG. 6 is a rear elevation view thereof; and,

FIG. 7 is a top, front and right side perspective view thereof in an extended position.

The broken line showing of cards in FIGS. 1-4 and 7 and a keyboard in FIG. 7 are for illustrative purposes only and form no part of the claimed design.

**1 Claim, 3 Drawing Sheets**

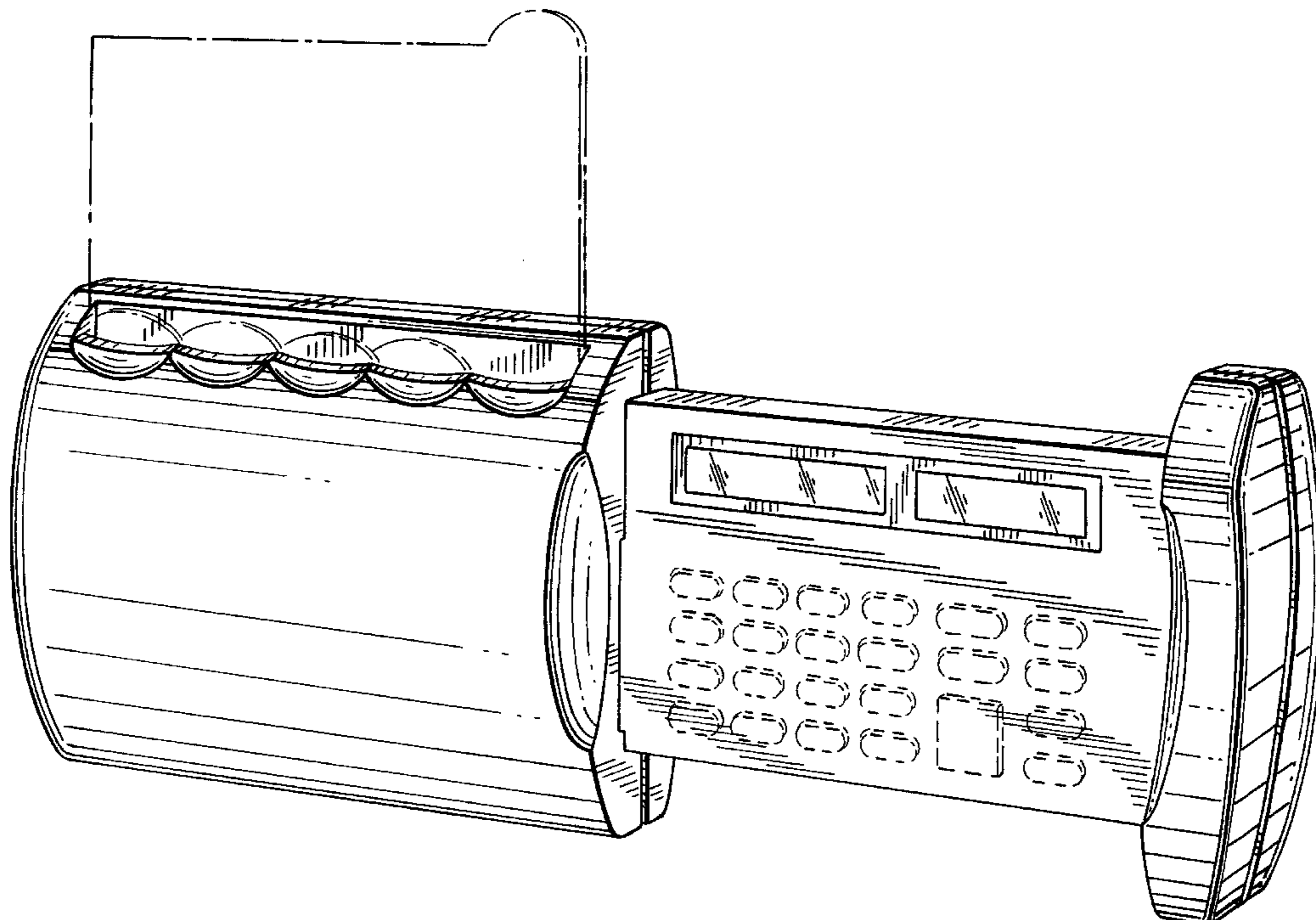
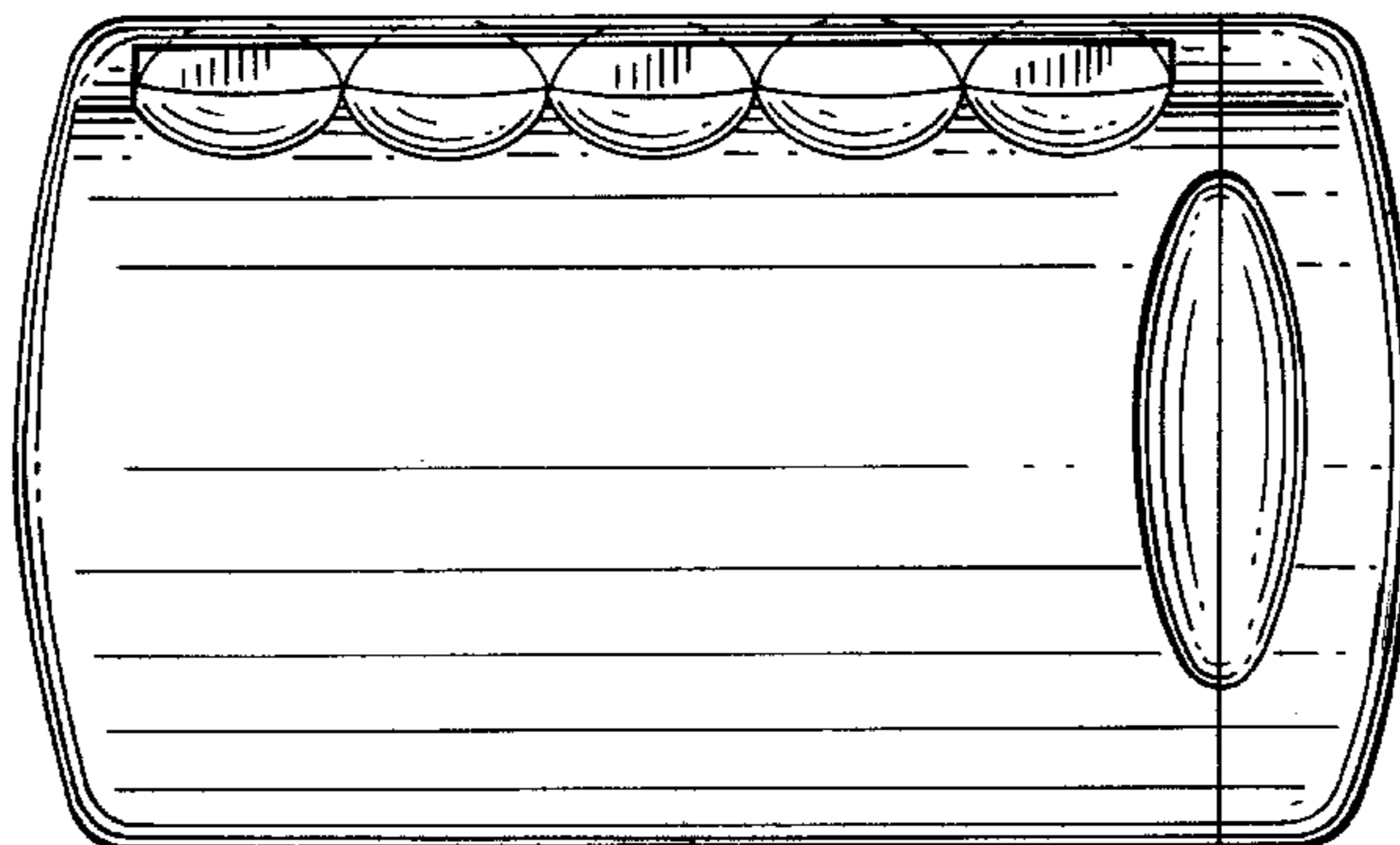

FIG. 1

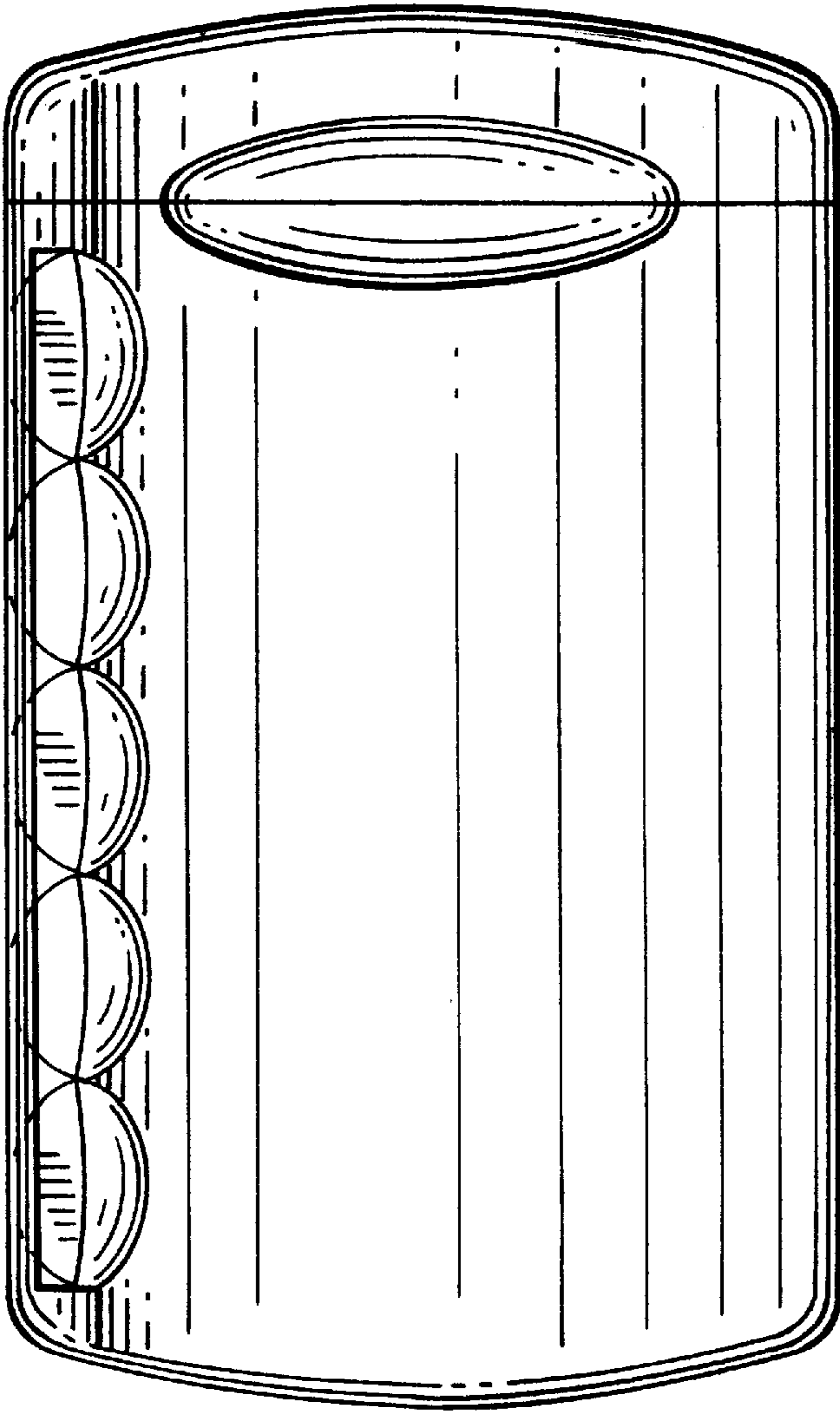

FIG. 3

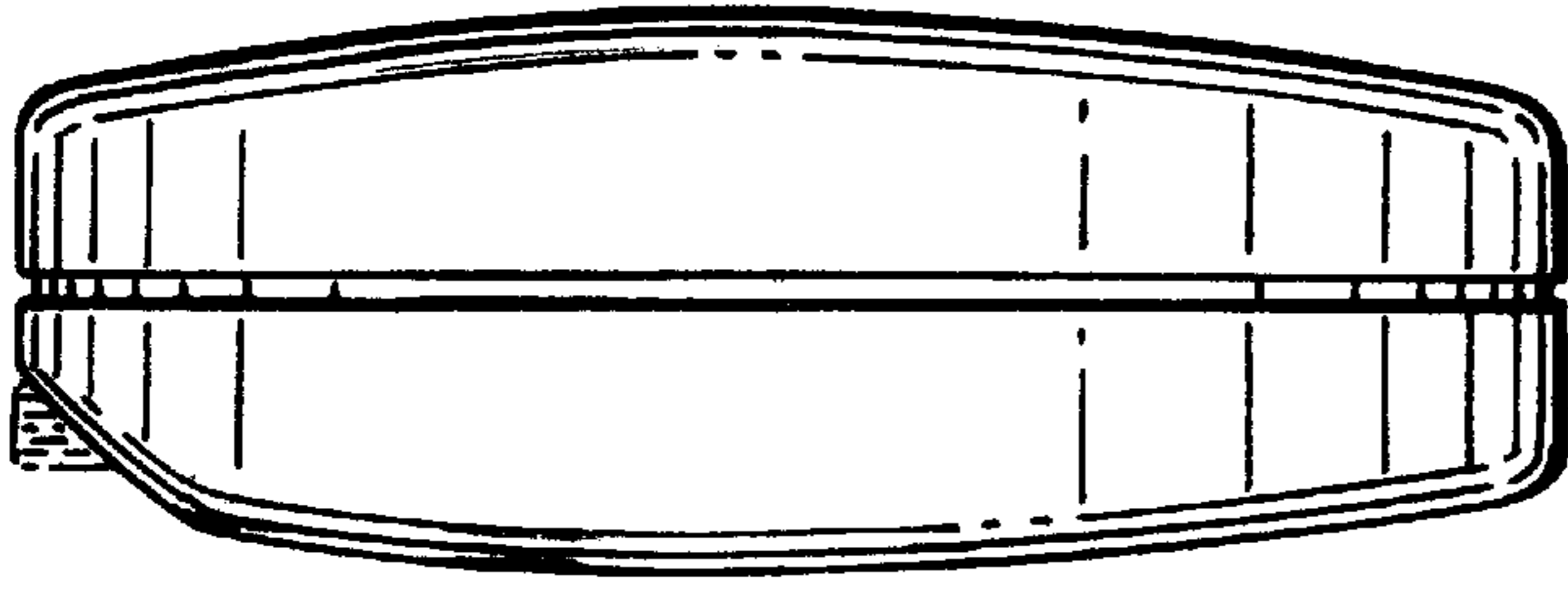

FIG. 2

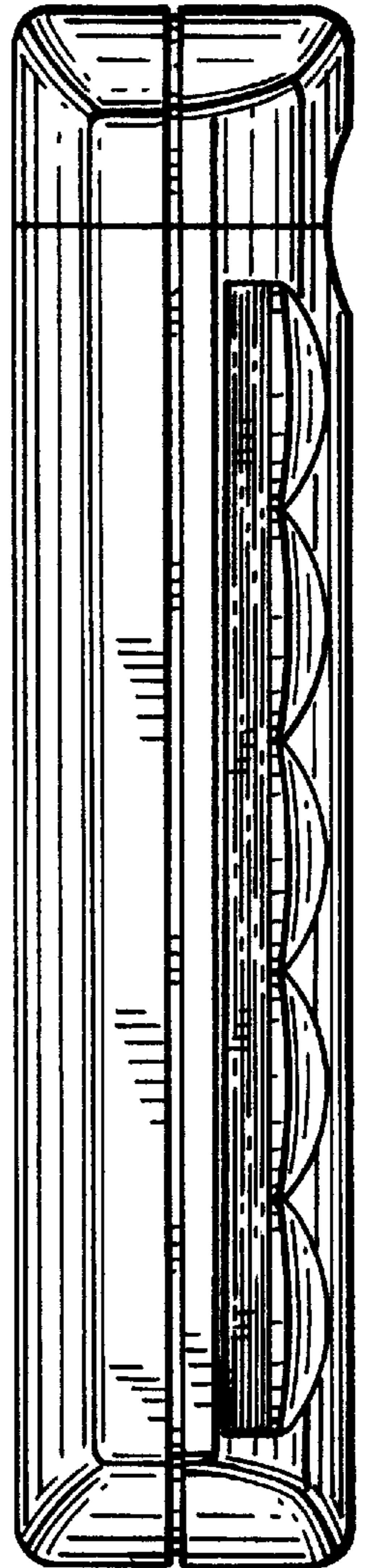

FIG. 5

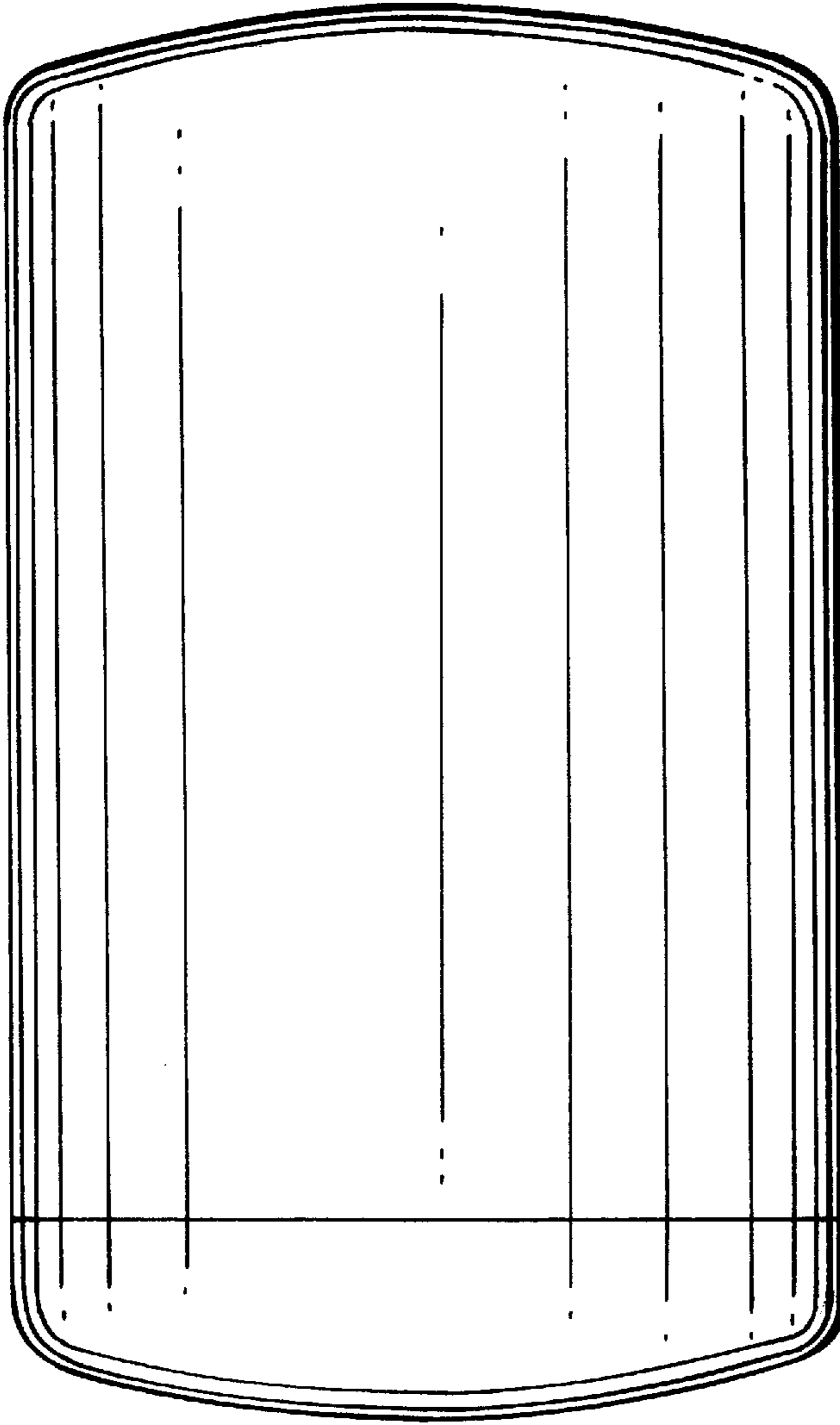

FIG. 4

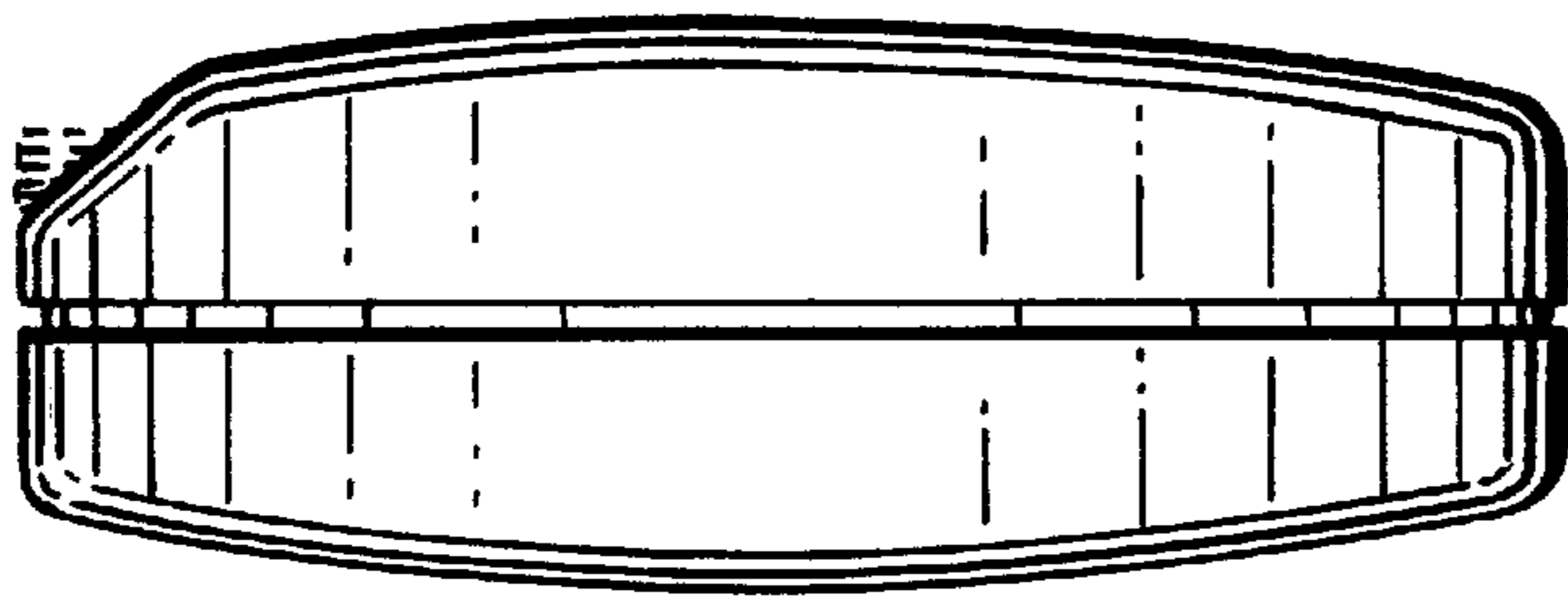

FIG. 6

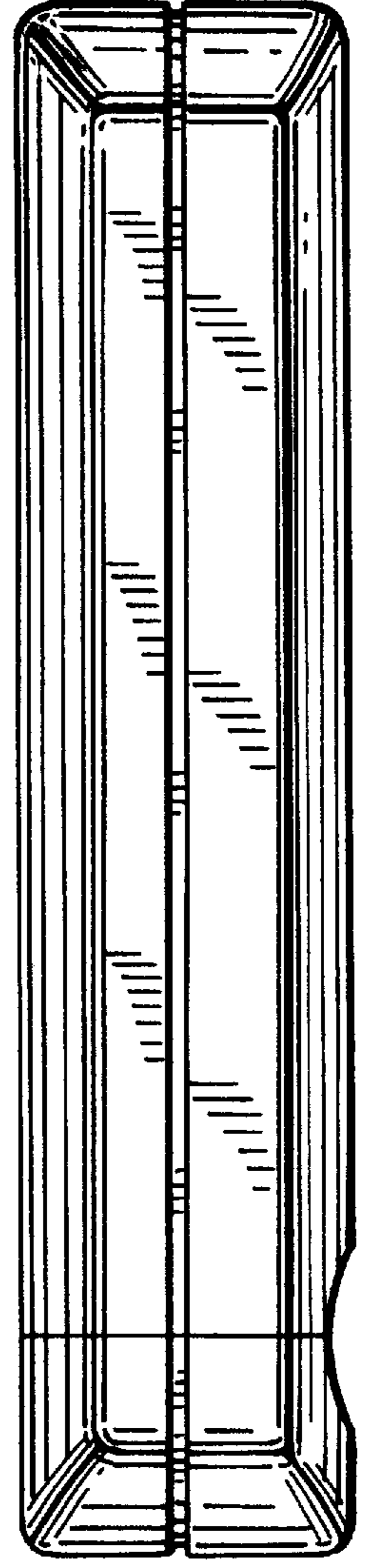

FIG. 7

