



US00D405435S

# United States Patent [19]

Brunner et al.

[11] Patent Number: Des. 405,435

[45] Date of Patent: \*\*Feb. 9, 1999

[54] COMPUTER MONITOR AND MONITOR STAND

[75] Inventors: Robert Brunner, Los Gatos; Simon Gatrall, San Francisco, both of Calif.

[73] Assignee: Toshiba America Information Systems, Inc., Irvine, Calif.

[\*\*] Term: 14 Years

[21] Appl. No.: 72,351

[22] Filed: Jun. 13, 1997

[51] LOC (6) Cl. .... 14-02

[52] U.S. Cl. .... D14/113

[58] Field of Search ..... D14/100, 113, D14/124-129, 101; 348/180, 184, 325, 739; 248/917-924; 345/104, 133, 156, 168, 87, 173, 901-905; 341/12

### [56] References Cited

#### U.S. PATENT DOCUMENTS

D. 369,150 4/1996 Vossoughi ..... D14/113

D. 372,235 7/1996 Starck ..... D14/126

Primary Examiner—Freda Nunn  
Attorney, Agent, or Firm—Limbach & Limbach L.L.P.

### [57] CLAIM

The ornamental design for a computer monitor and monitor stand, as shown and described.

### DESCRIPTION

FIG. 1 is a front view of a computer monitor and monitor stand showing our new design;  
FIG. 2 is a right side elevation view thereof, the left side being a mirror image thereof;  
FIG. 3 is a rear elevation view thereof;  
FIG. 4 is a bottom view thereof;  
FIG. 5 is a top rear and right side perspective view thereof;  
FIG. 6 is a top plan view thereof.

1 Claim, 6 Drawing Sheets

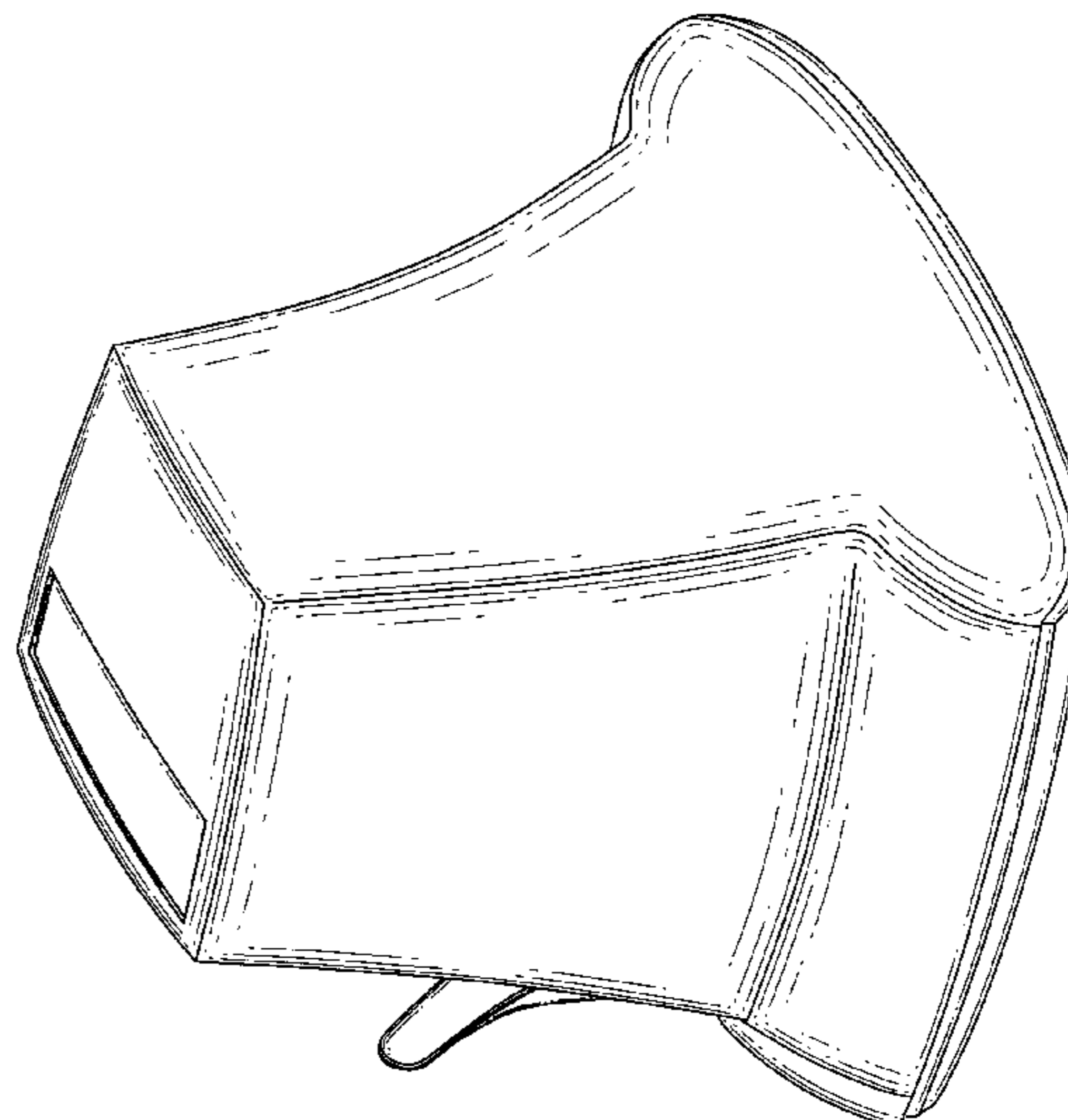
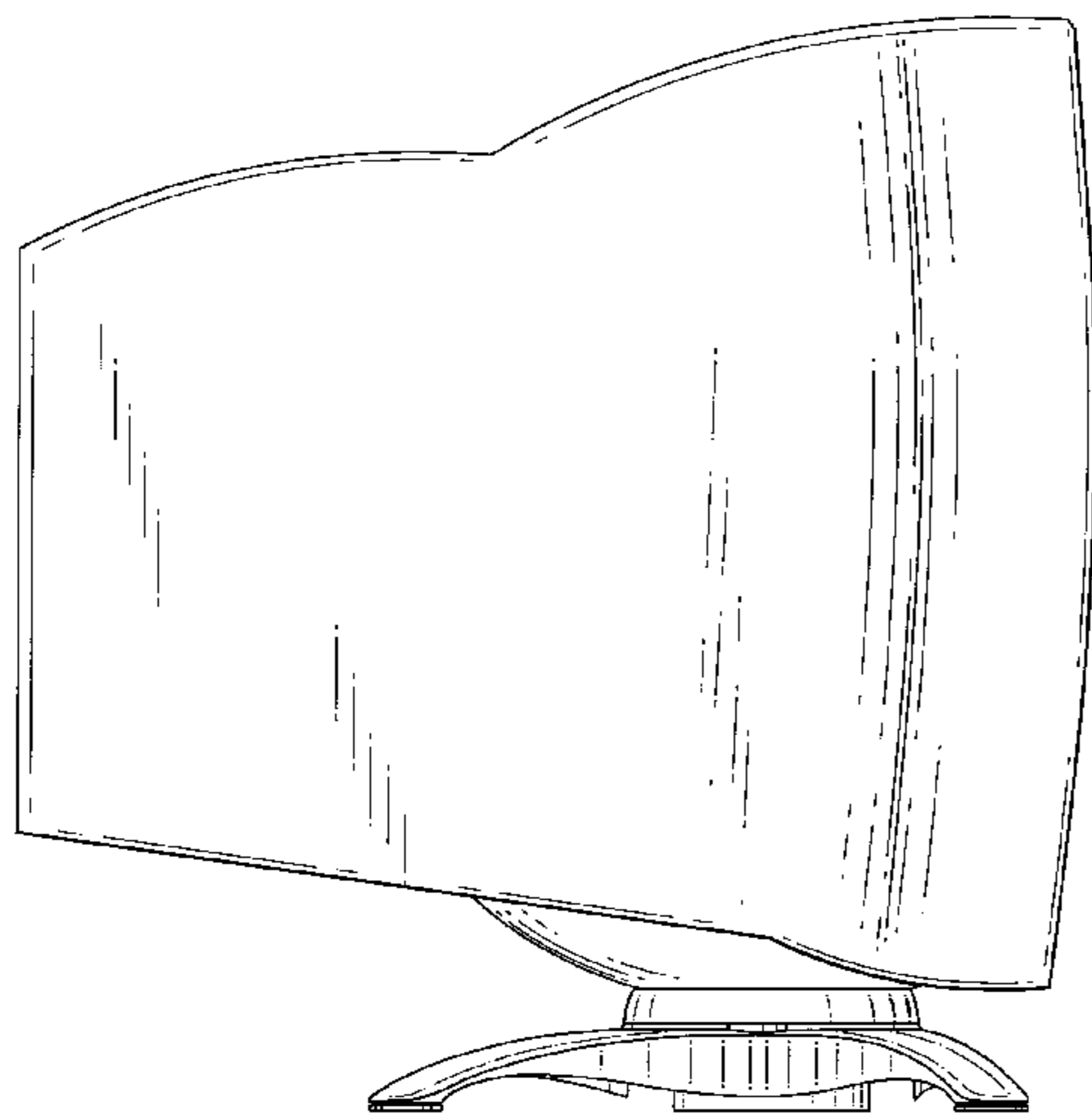
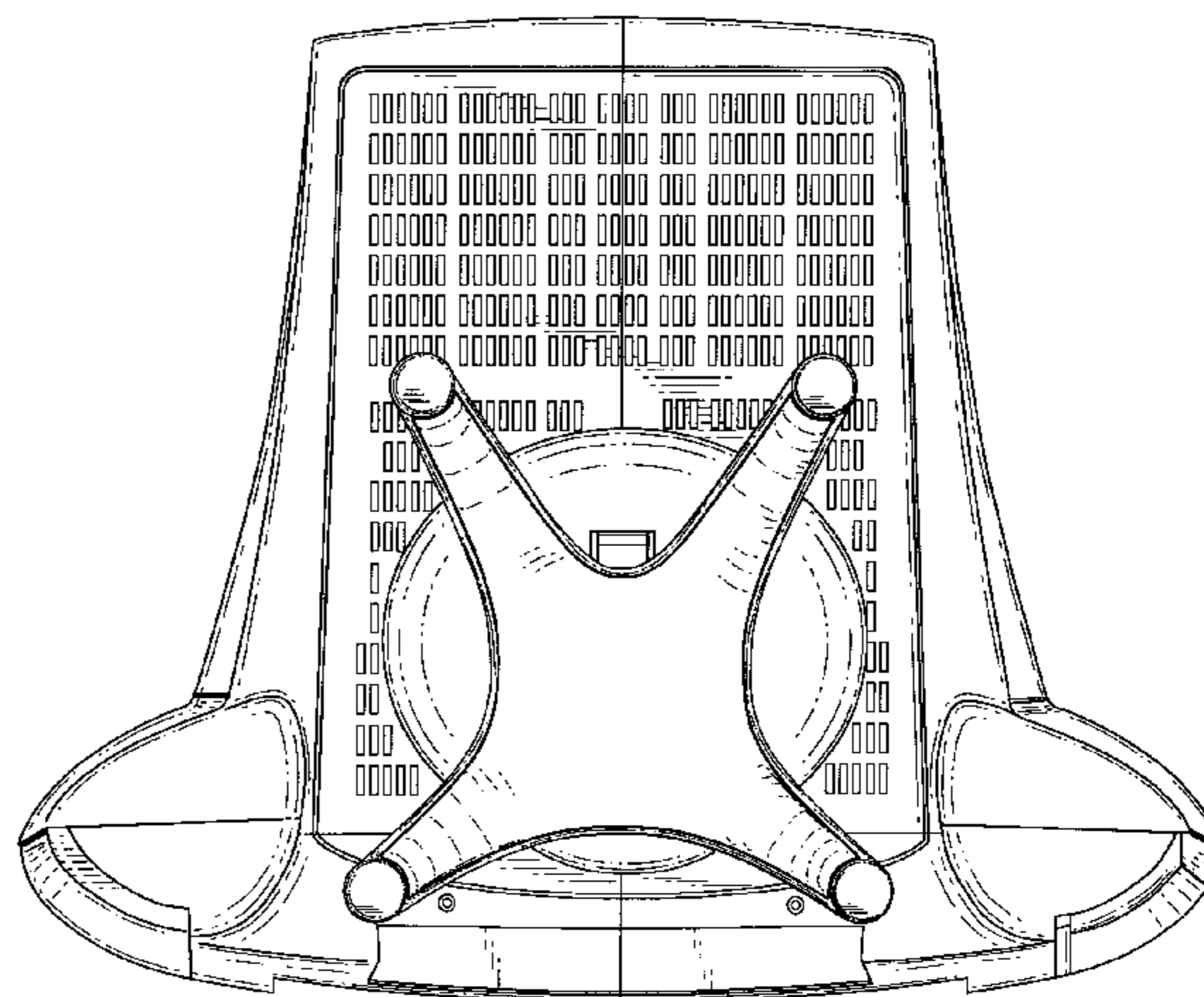
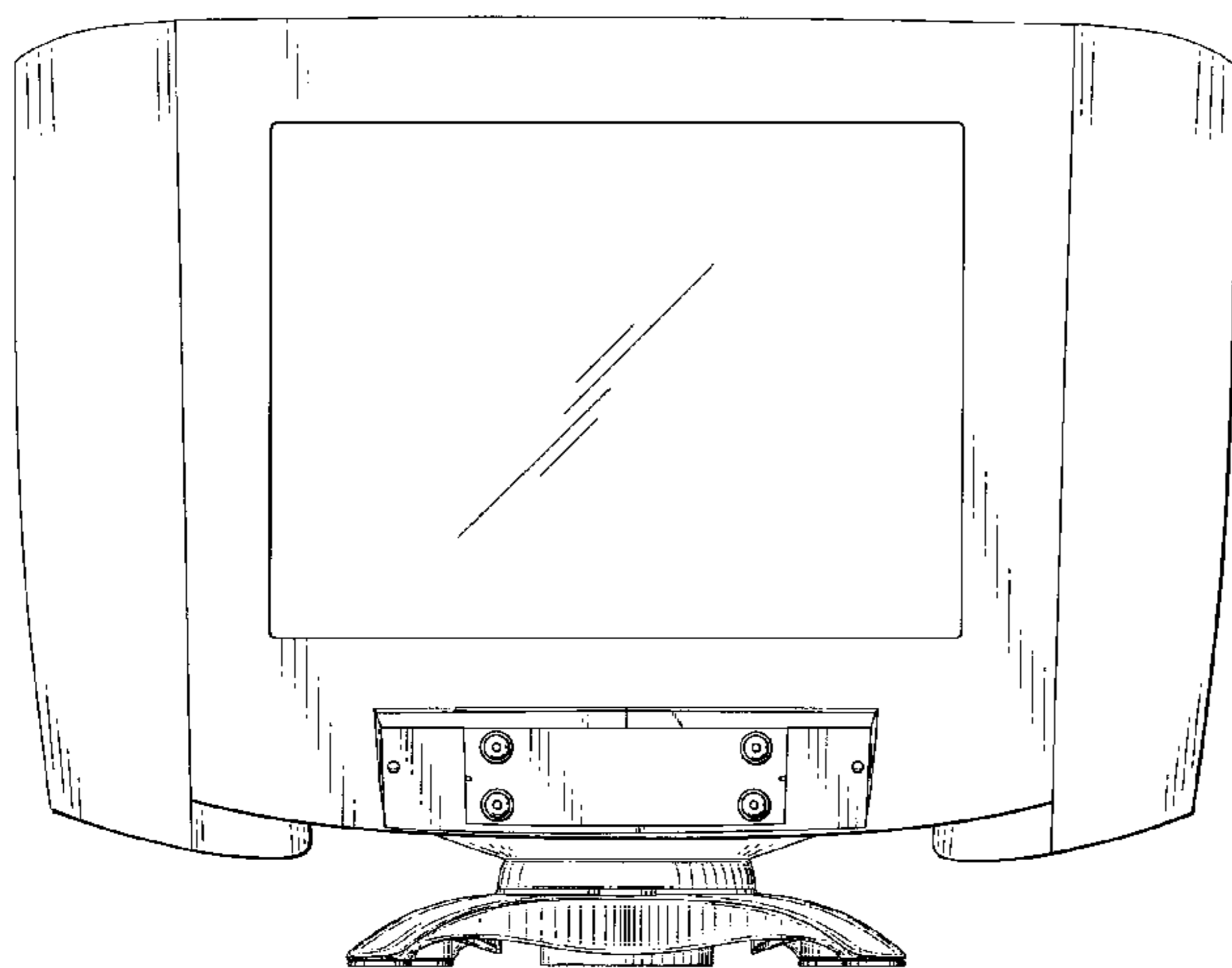

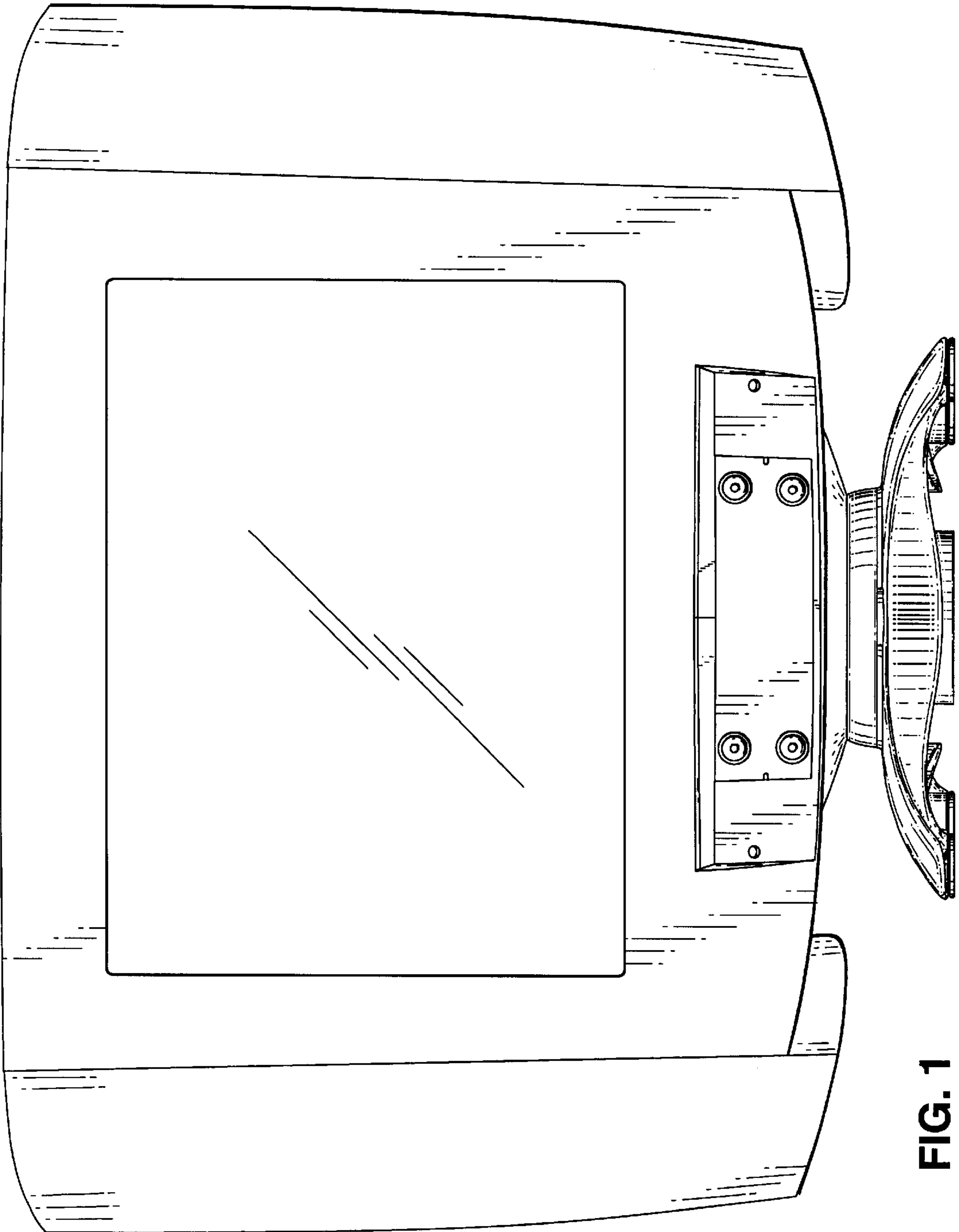

FIG. 1

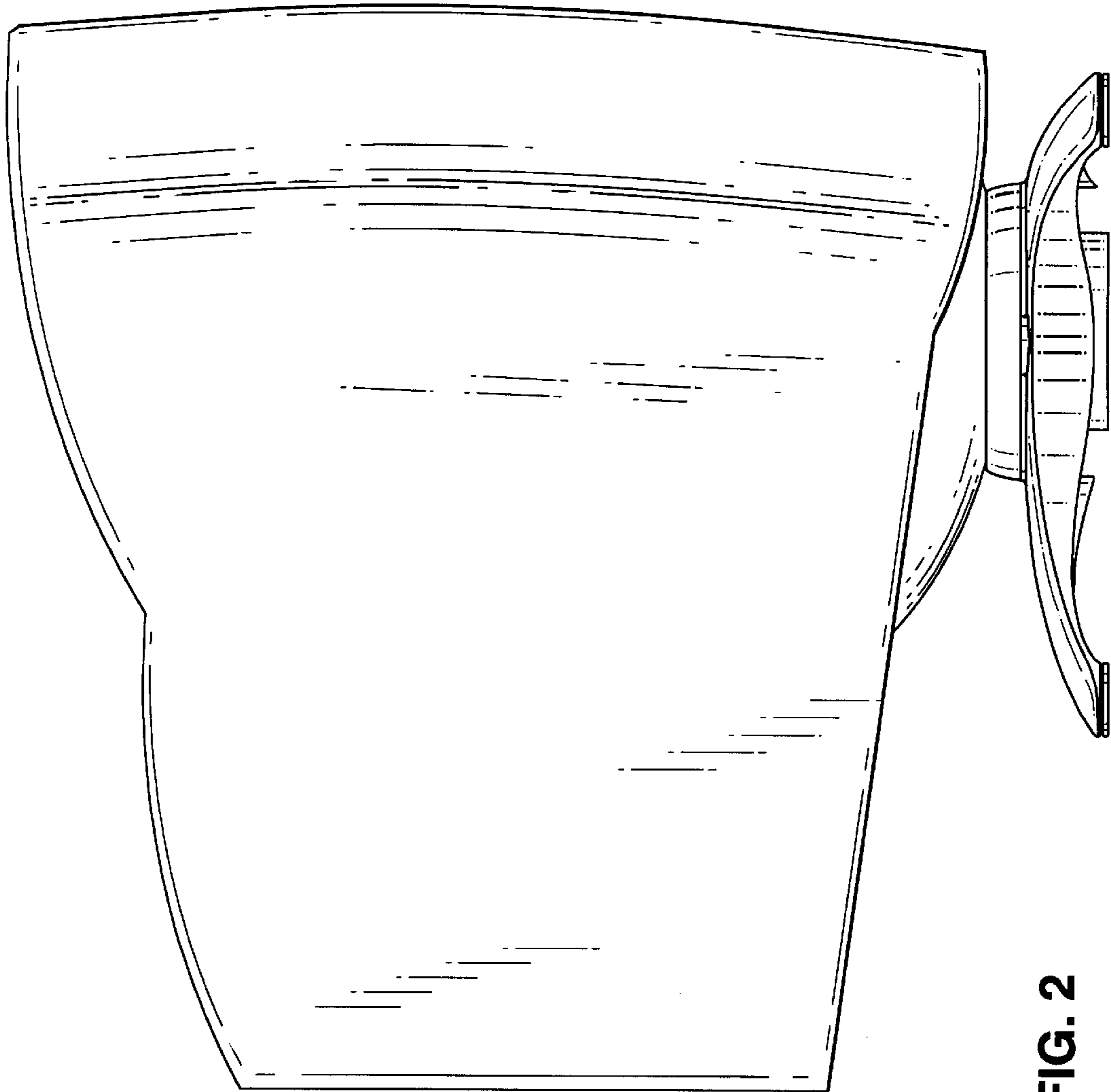

FIG. 2

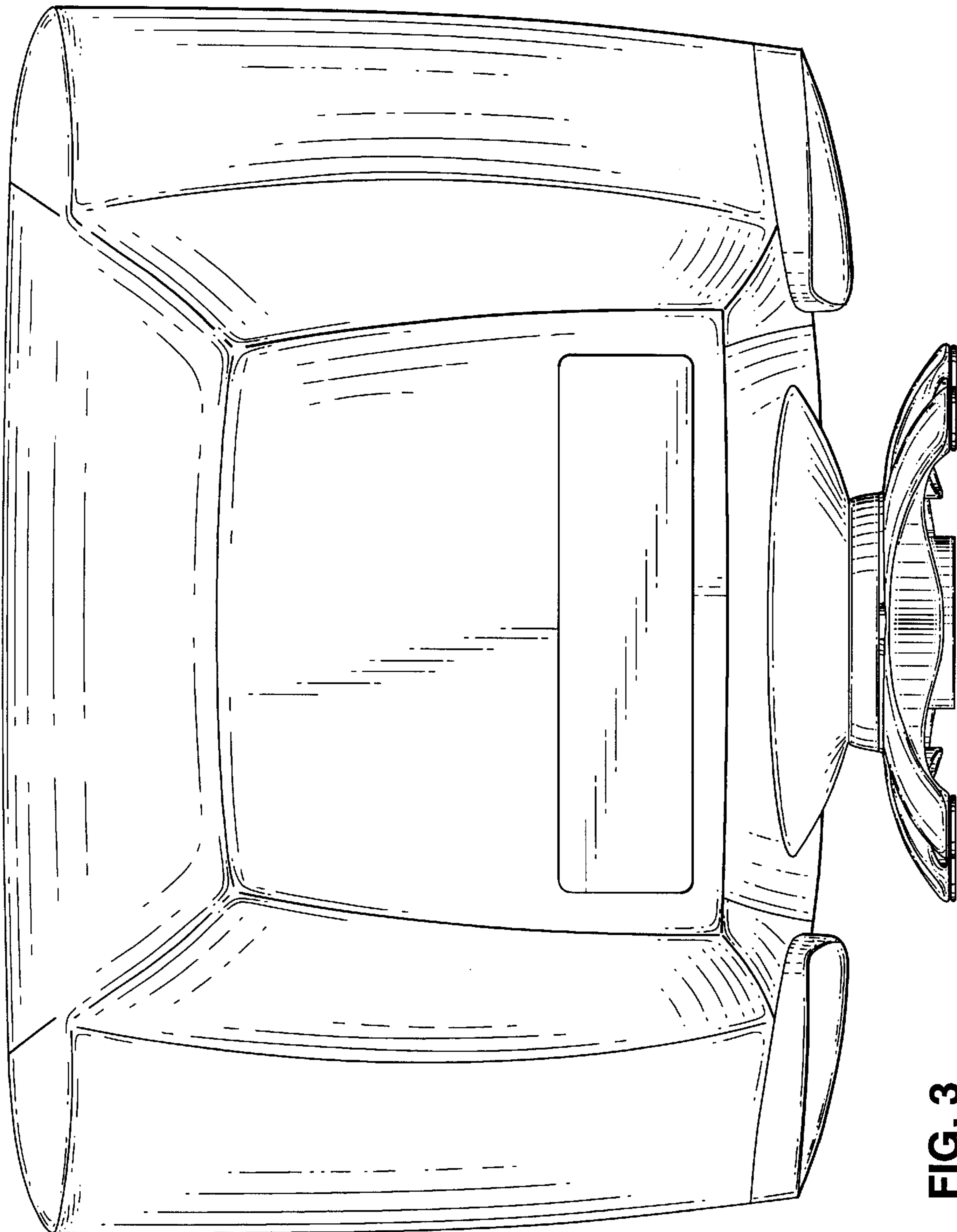

FIG. 3

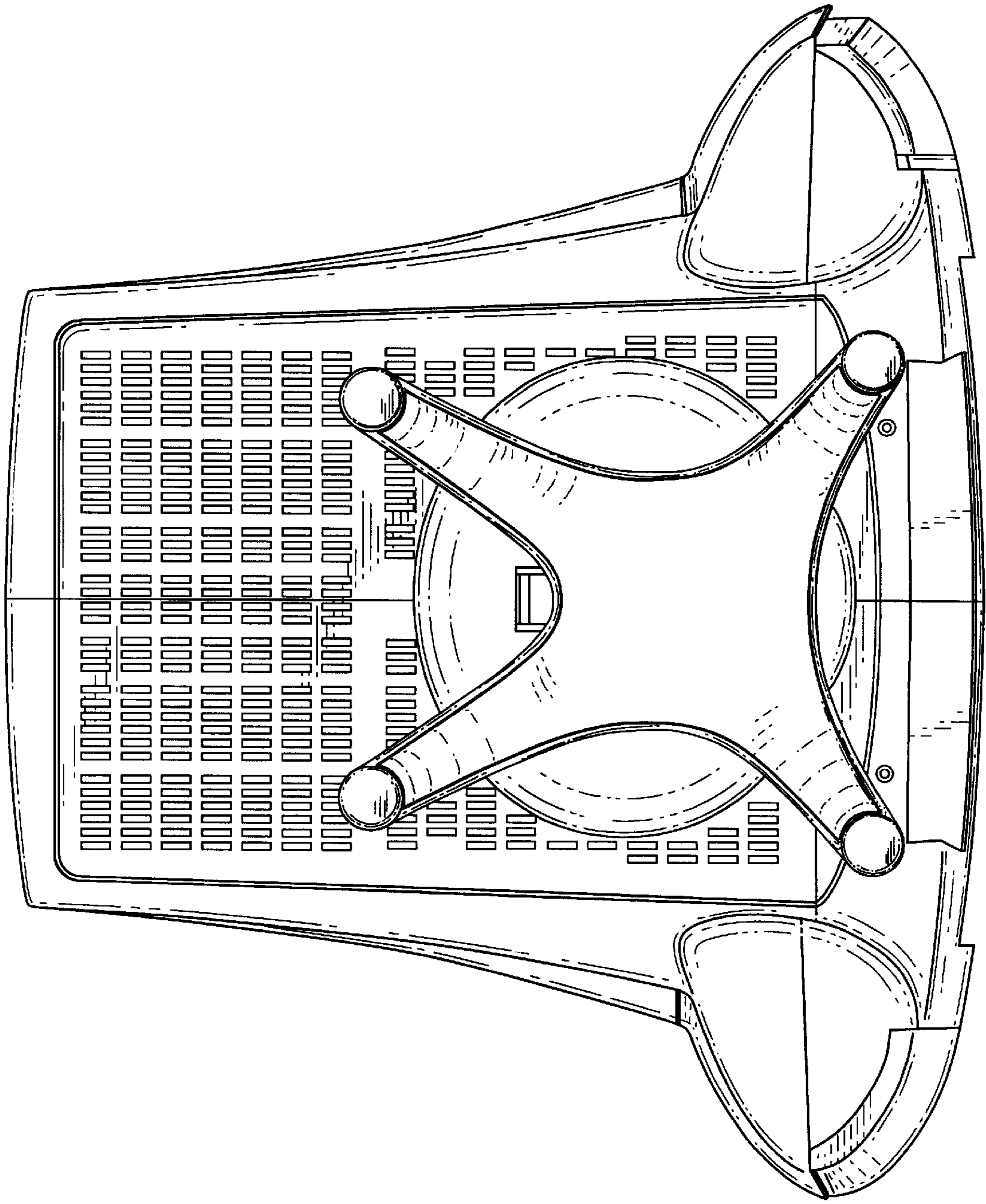

FIG. 4

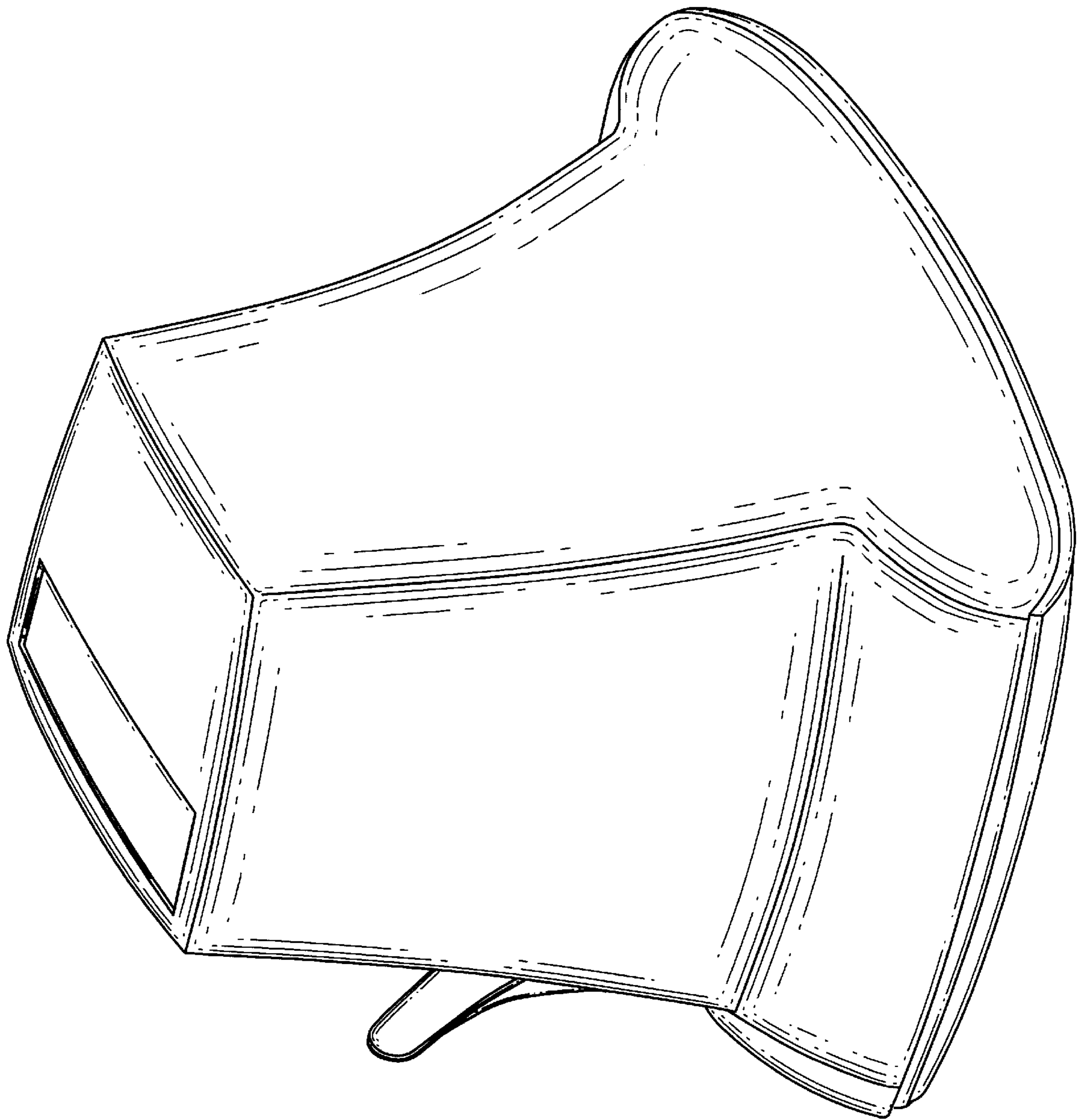

FIG. 5

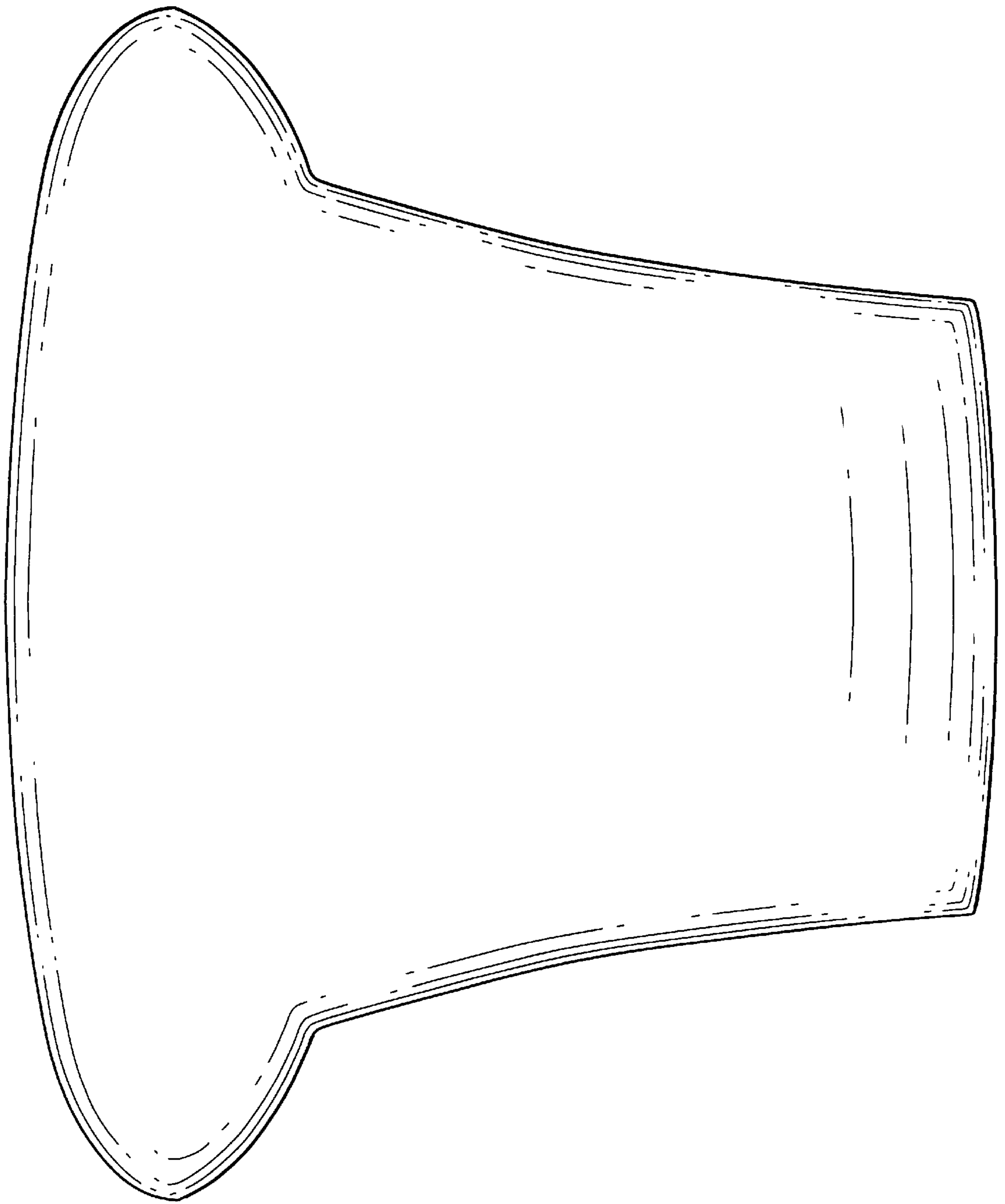

FIG. 6