



US00D405413S

**United States Patent** [19]  
**Segers**

[11] **Patent Number: Des. 405,413**

[45] **Date of Patent: \*\*Feb. 9, 1999**

[54] **BATTERY PACK FOR A MOBILE  
RADIOTELEPHONE DEVICE**

[75] Inventor: **Reinhard Segers**, Munich, Germany

[73] Assignee: **Siemens Aktiengesellschaft**, Munich,  
Germany

[\*\*] Term: **14 Years**

[21] Appl. No.: **81,415**

[22] Filed: **Dec. 31, 1997**

[30] **Foreign Application Priority Data**

Jul. 3, 1997 [DE] Germany ..... M9706126.3

[51] **LOC (6) Cl.** ..... **13-02**

[52] **U.S. Cl.** ..... **D13/103**

[58] **Field of Search** ..... D13/103; D14/138;  
429/96-100, 176, 163; 455/127, 343

[56] **References Cited**

**U.S. PATENT DOCUMENTS**

D. 382,536 8/1997 Amero, Jr. .... D13/103

D. 391,622 3/1998 Huynh et al. .... D13/103

5,436,088 7/1995 Castaneda et al. .... 429/96

*Primary Examiner*—Joel Sincavage  
*Attorney, Agent, or Firm*—Hill & Simpson

[57] **CLAIM**

The ornamental design for a battery pack for a mobile radio telephone device, as shown and described.

**DESCRIPTION**

FIG. 1 is a perspective view of a battery pack according to the present invention;

FIG. 2 is a front elevational view of the battery pack of FIG. 1;

FIG. 3 is a back elevational view of the battery pack of FIG. 1;

FIG. 4 is a side view of the left side of the battery pack of FIG. 2;

FIG. 5 is a side view of the right side of the battery pack of FIG. 2;

FIG. 6 is a bottom end view of the battery pack of FIG. 2;

FIG. 7 is an end view of the top of the battery pack of FIG. 2; and,

FIG. 8 is a perspective view of the new battery pack being inserted into a mobile radiotelephone device utilizing such a battery pack.

The broken line showing the mobile telephone device in FIG. 8 is included for the purpose of illustrating the environmental elements only and forms no part of the claimed design.

**1 Claim, 3 Drawing Sheets**

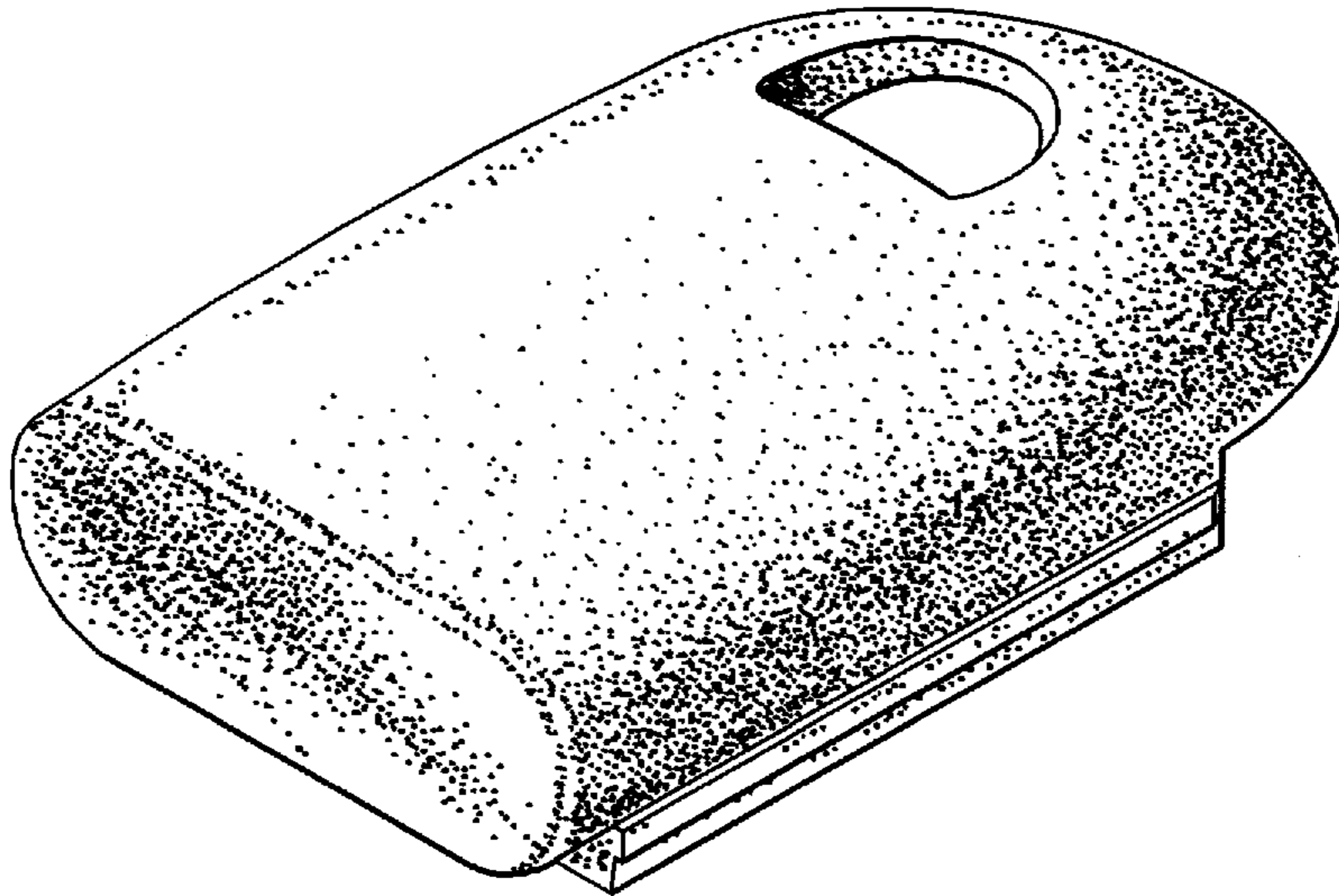

FIG. 1

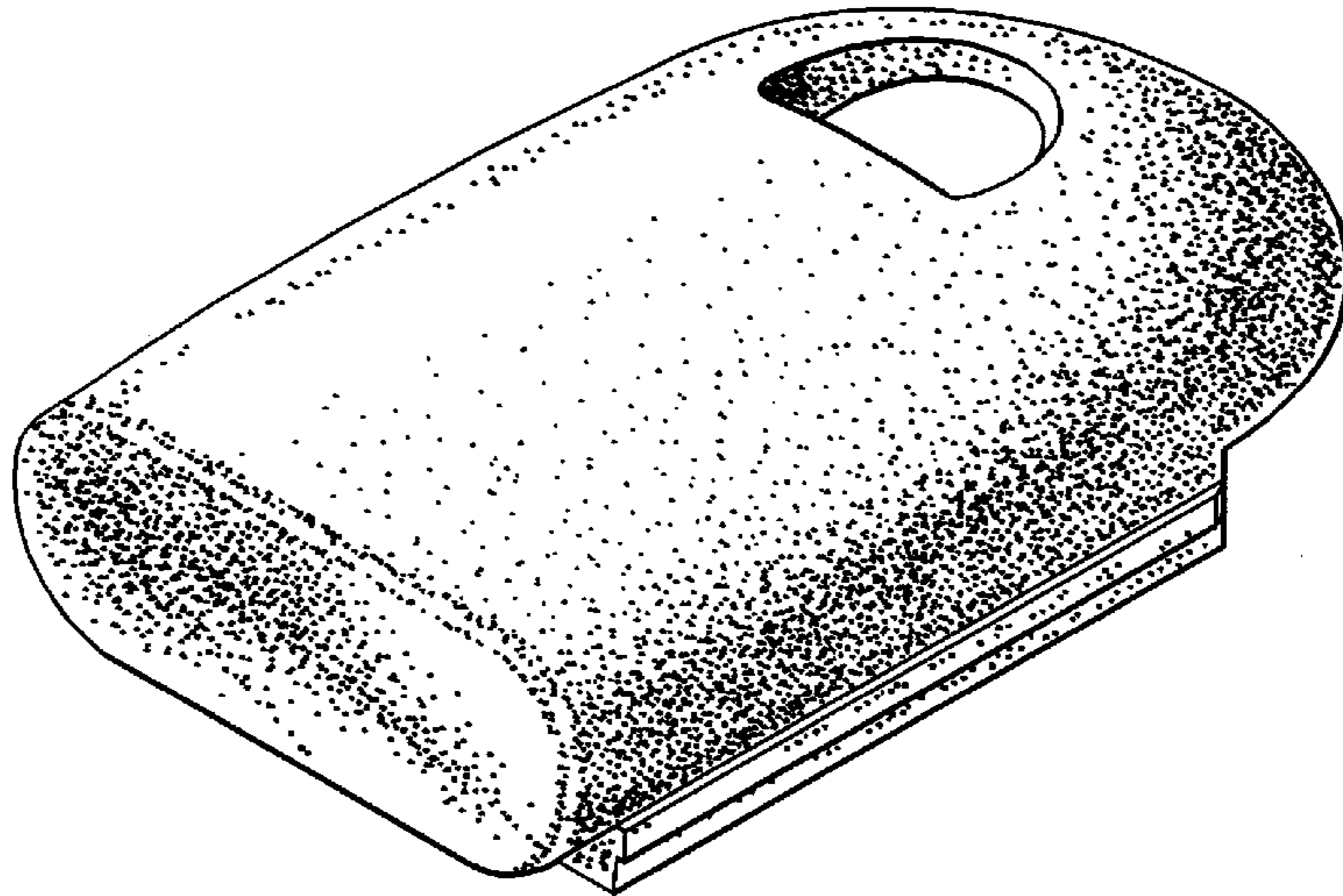

FIG. 2

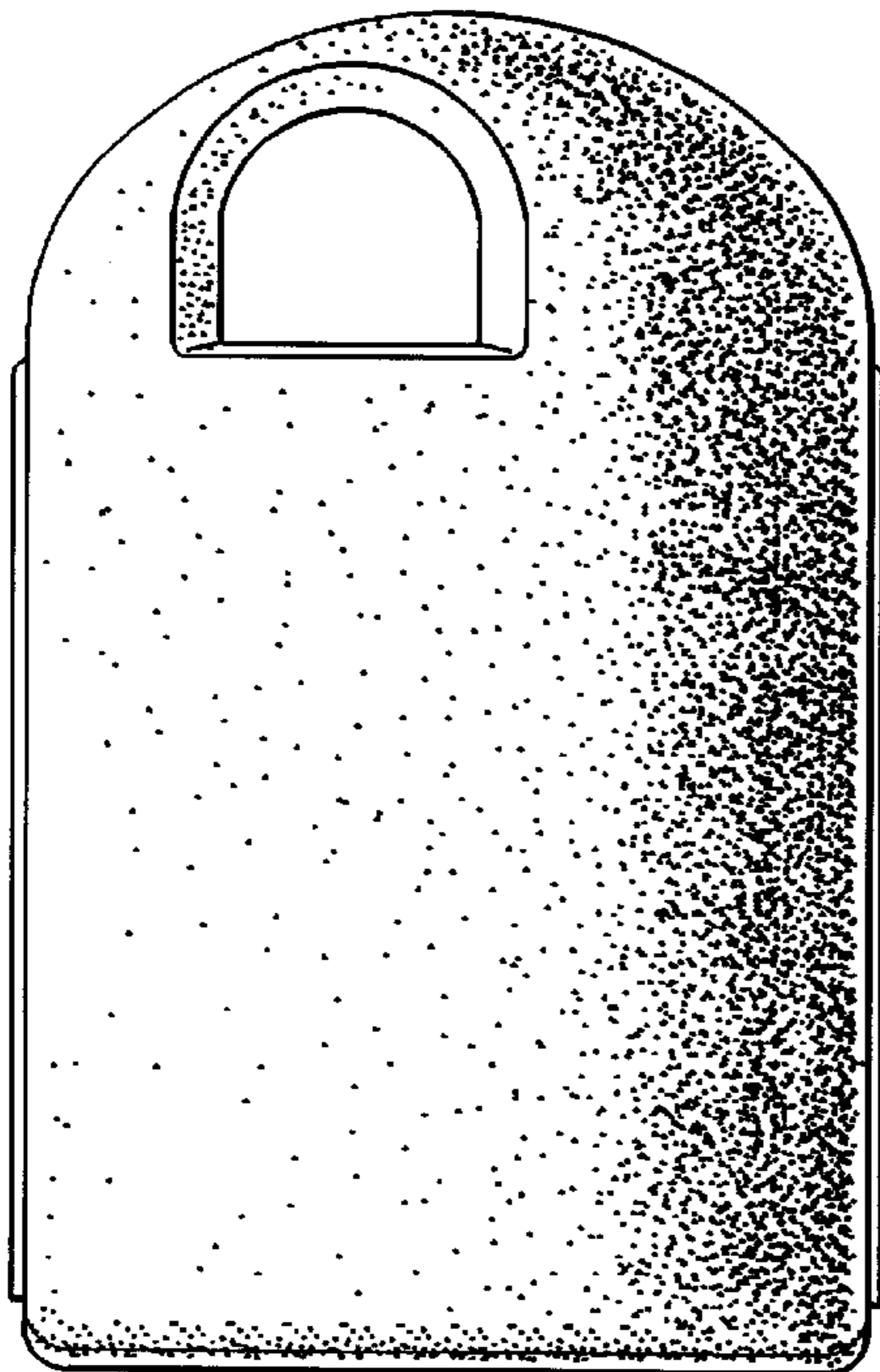

FIG. 3

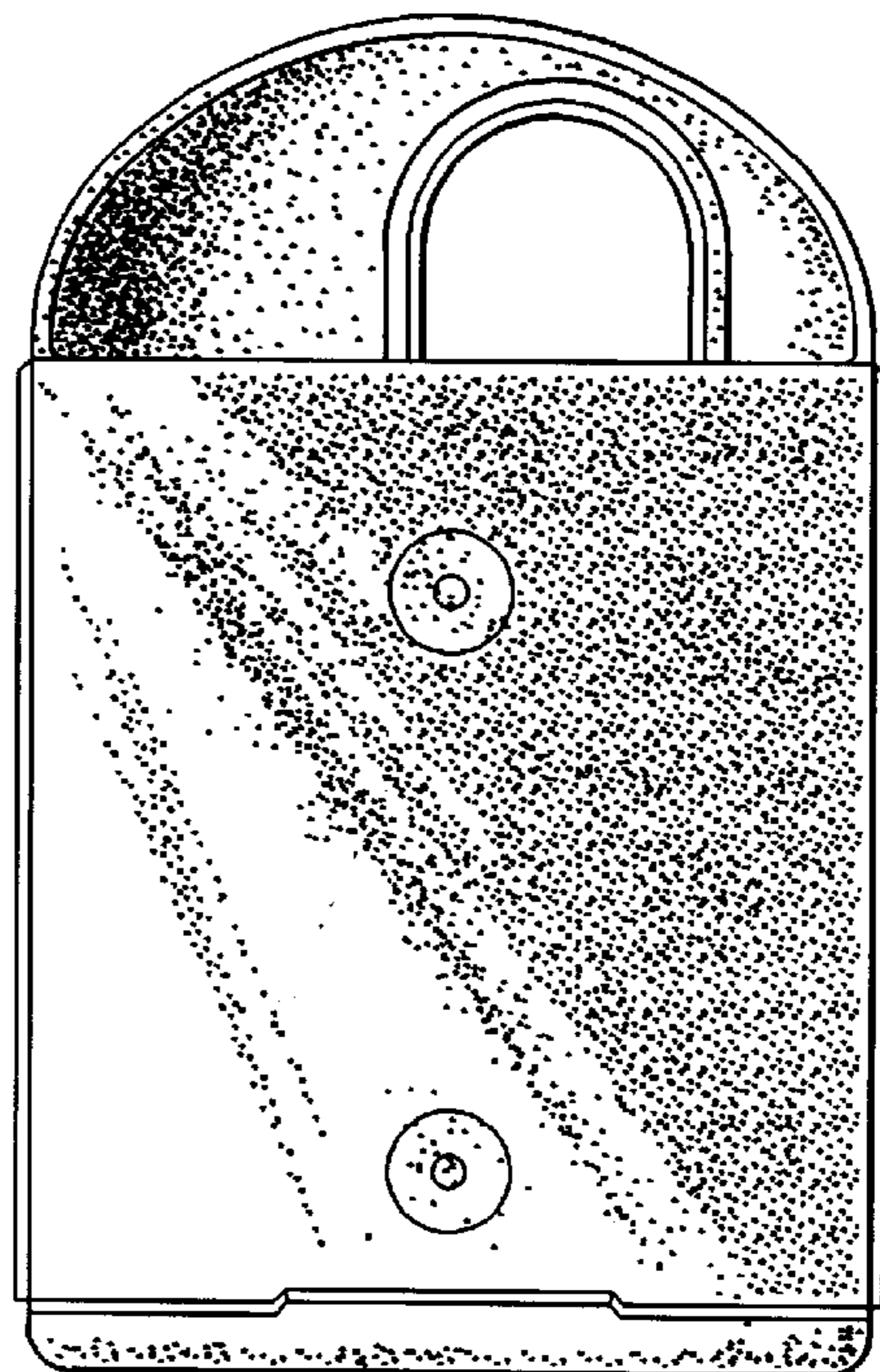

FIG. 4

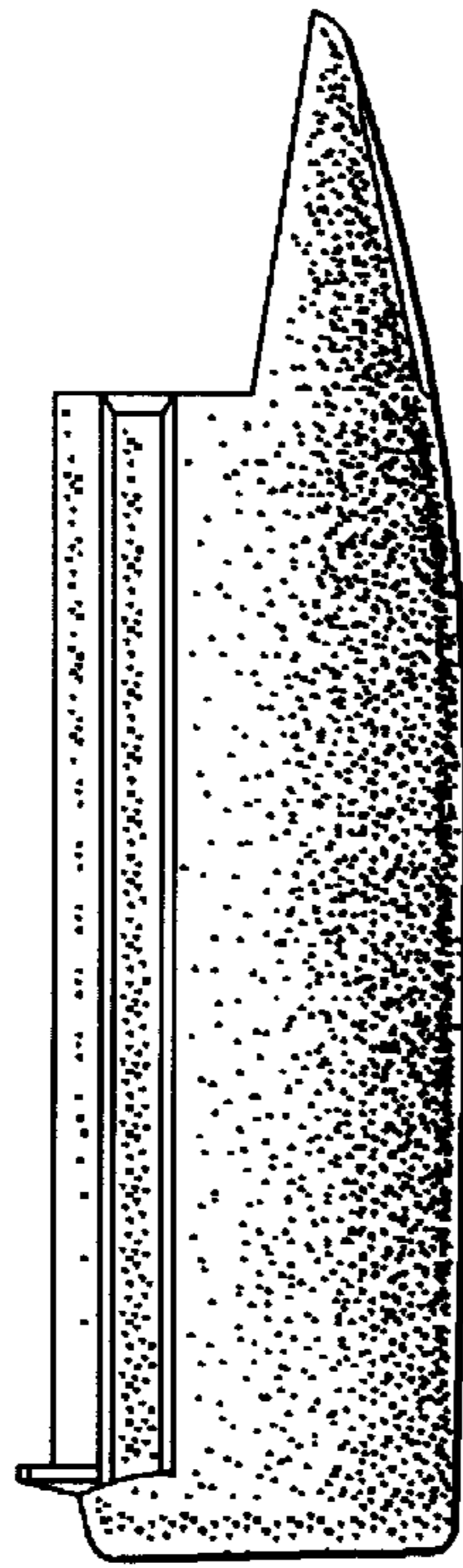

FIG. 5

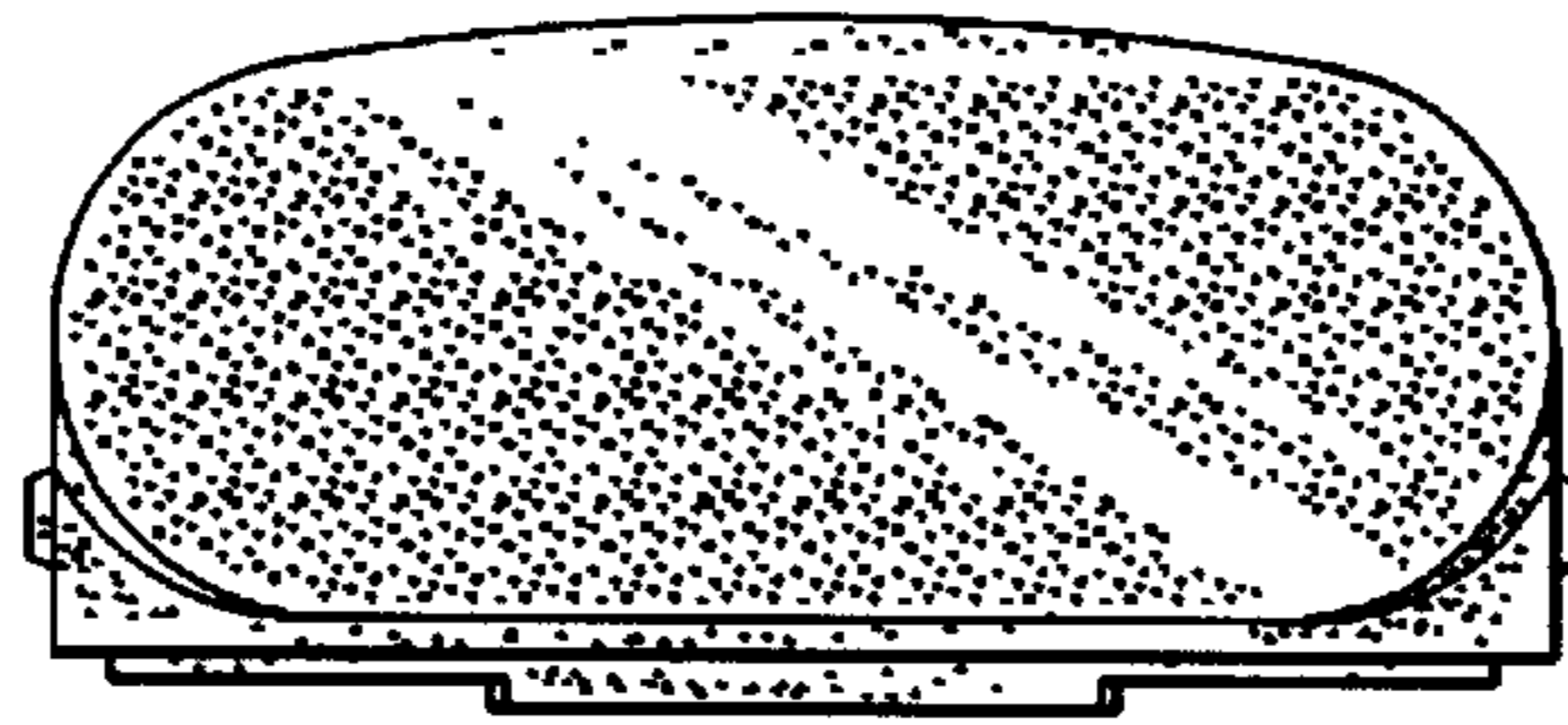
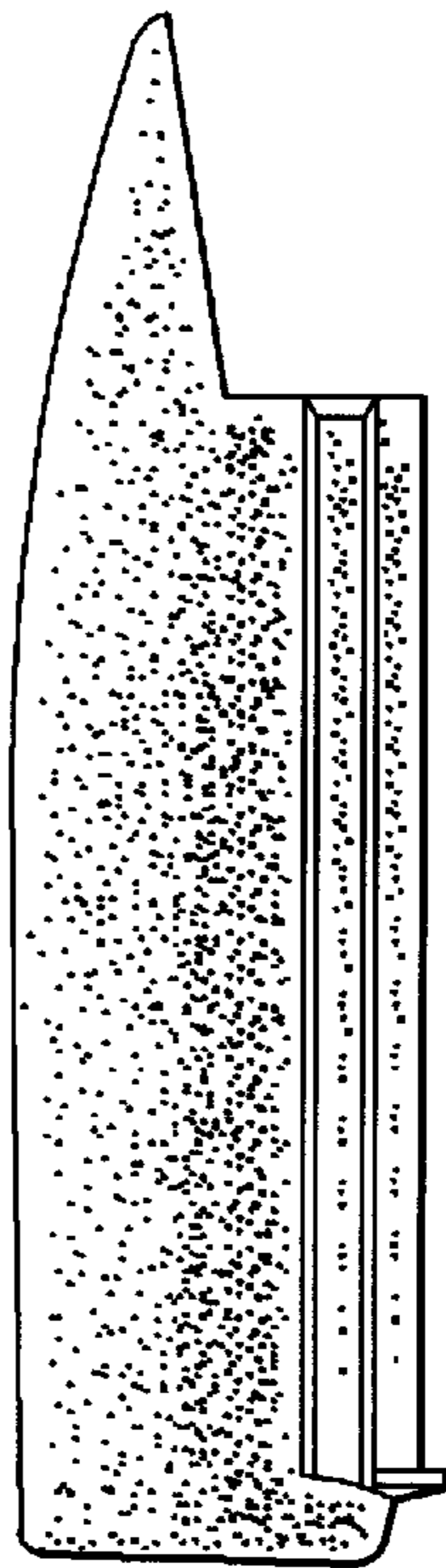
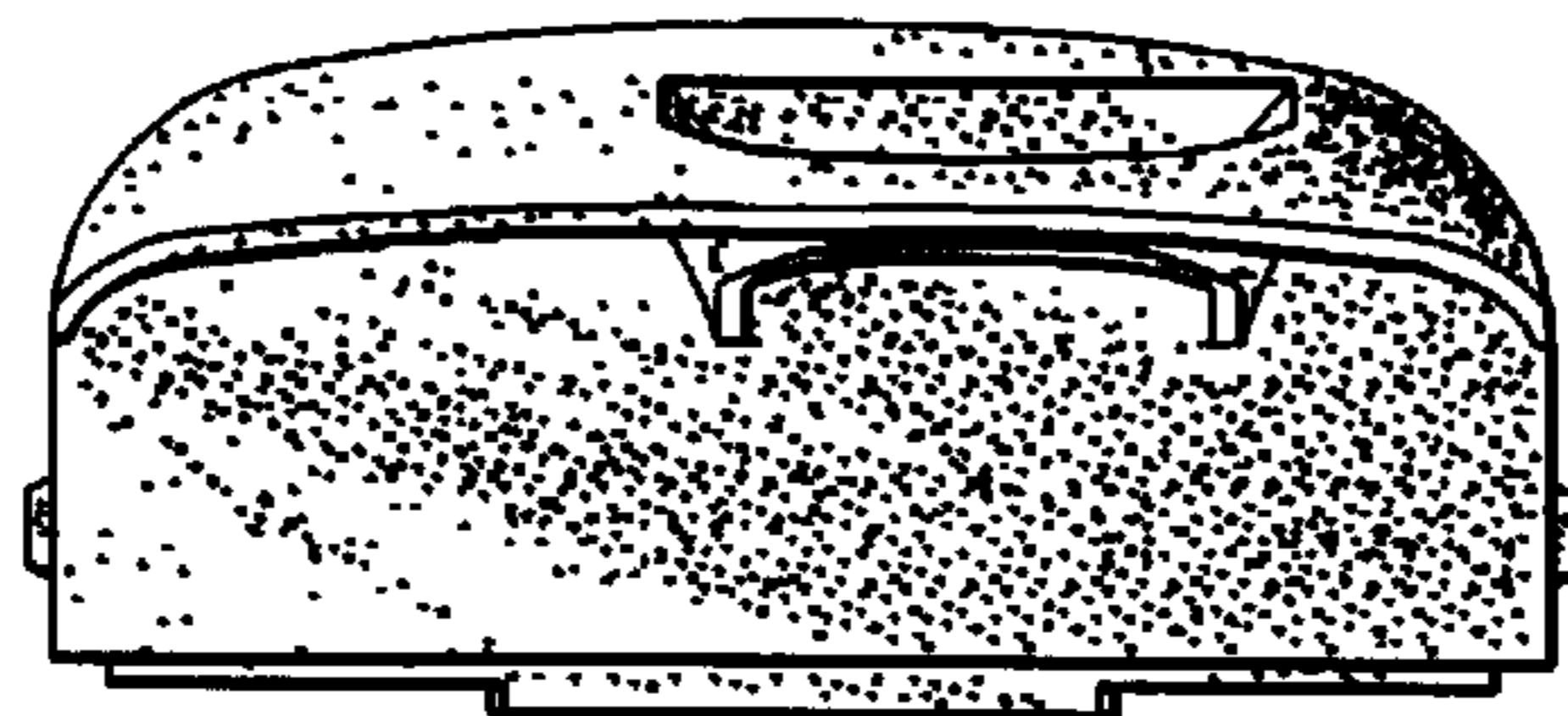

FIG. 6

FIG. 7



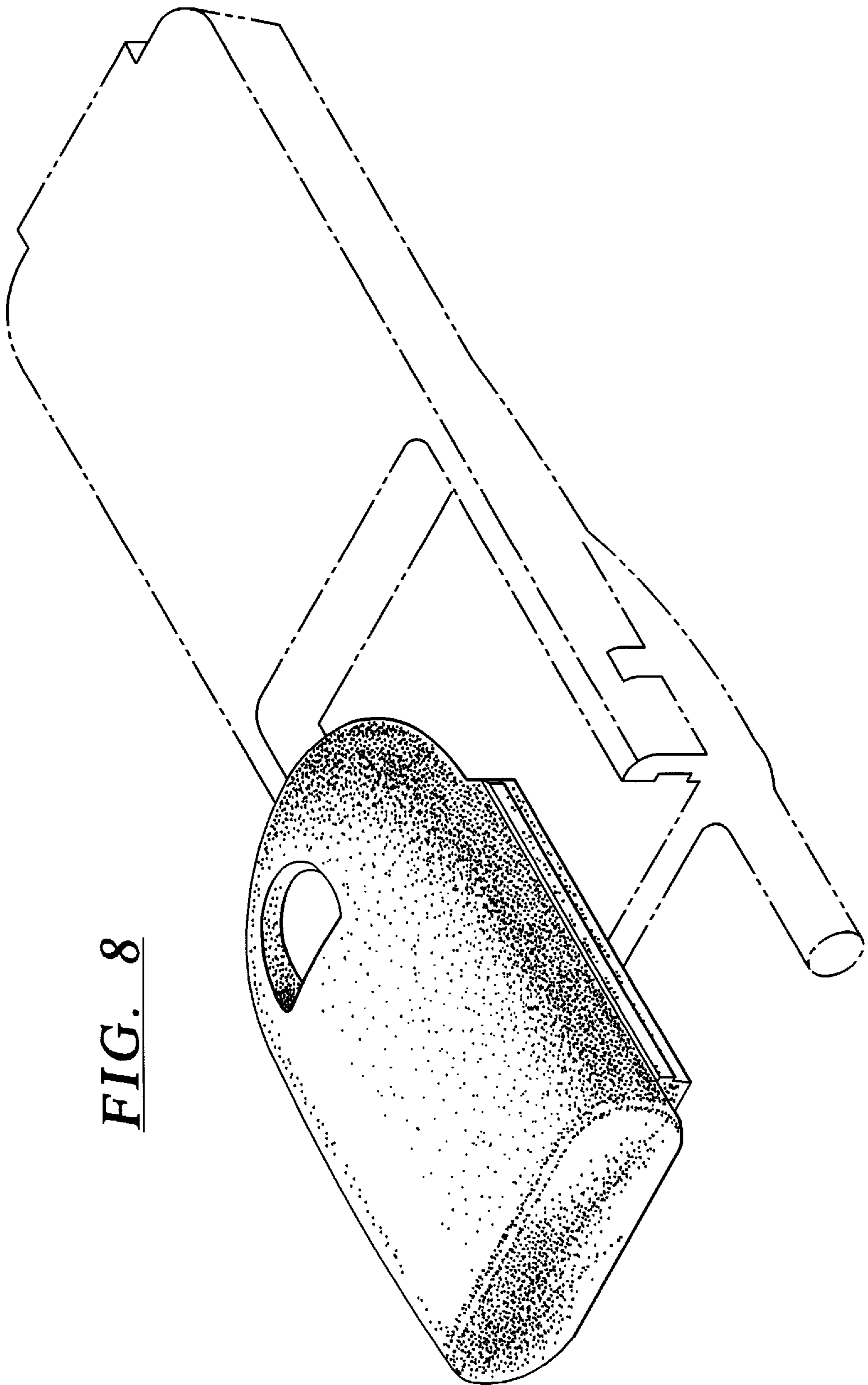

FIG. 8